



Quick Start Guide

Bush 10.1" MyTablet

Table of contents

Package contents.....	2
Description of the device.....	4
Getting started.....	6
Connecting to a WiFi network.....	8
The Android™ interface.....	10
Getting familiar with Android™.....	14
Troubleshooting.....	18

For more information, please consult the FAQs on www.argos.co.uk. Make sure to read them before considering any product return. As we are often updating and improving our products, your device' software may have a slightly different appearance or modified functionality than presented in this Quick Start Guide.

Package contents



BUSH Tablet



QSG booklet



Warranty,
legal & safety
booklet



USB cable

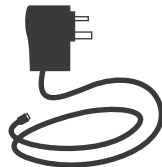

Charger

Charger assembly

Assembly: twist the plug clockwise until click.

Disassembly: press button ① and turn counter-clockwise.

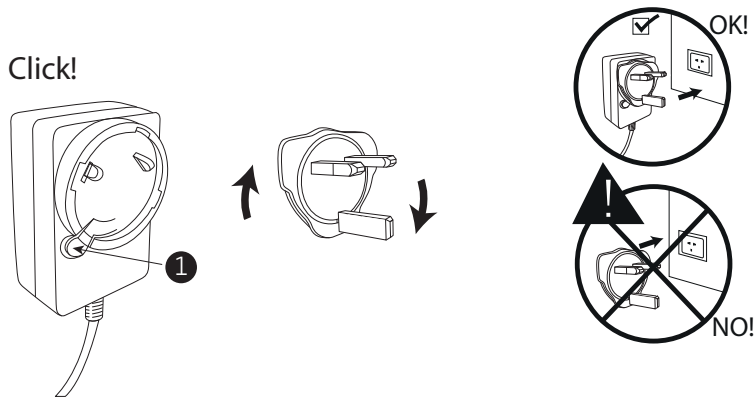

Description of the device

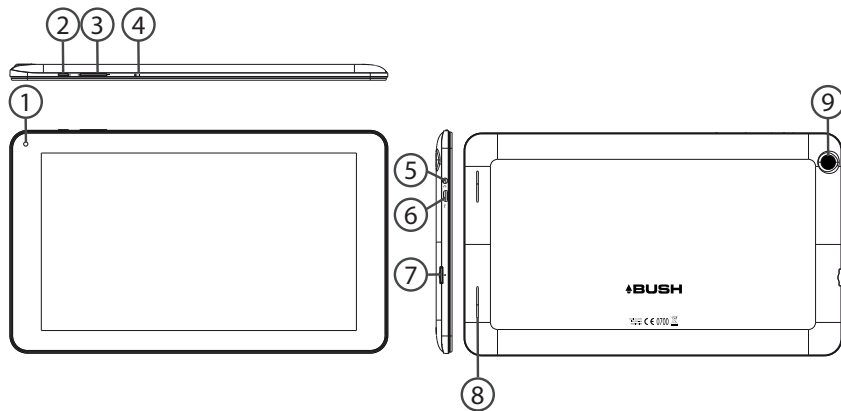

-
- ① Webcam
 - ② ON/OFF button
 - ③ Volume buttons
 - ④ Microphone
 - ⑤ Headphone jack
 - ⑥ Micro-USB port
 - ⑦ Micro-SD card slot
 - ⑧ Loudspeakers
 - ⑨ Camera

Getting started

Before you switch on for the first time, ensure that:

1. Your tablet is fully charged
2. You have a good WiFi connection (ideally your usual WiFi zone)
3. You have your WiFi name and password to hand.

Charging

Connect the supplied power cable to the device and to a wall outlet. The Bush device will start charging. You can use the device whilst on charge .

Turning the device on

Press the ON/OFF button for 2-3 seconds.

Startup Wizard

The first time you start up your device, the startup wizard will help you set up your device:

- Language
- Date & time
- WiFi connection
- Location service options
- Third-party applications

We strongly recommend that you open a Google account (you need this to download new apps) and we recommend that you answer yes to backing up your tablet to the Google account. This will save your files and settings in case you need to restore your tablet to factory defaults at any point.

Connecting to a WiFi network

WARNING: Make sure that you are in a WiFi zone.



- ① Touch 'Settings' to open the WiFi settings menu.



- ② If the WiFi is off, slide the WiFi switch to the 'ON' position. Once the WiFi is ON, the device will scan for WiFi networks in range.

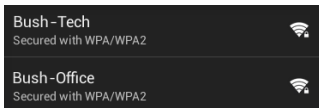

- ③ Touch the name of network you want to connect to. Private networks are shown with a lock icon and will require you to enter your password.

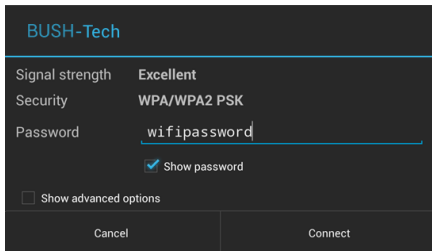

When entering a WiFi password, we recommend that you select 'Show password' so you can see the characters you are typing.

TIPS:

- To get the correct WiFi password (or settings) for the network, contact the WiFi network provider.
- If your WiFi is on and you are in range of a network that you previously connected to, your device will automatically attempt to connect to it.
- To keep your WiFi connection ON when the device is on sleep, select the Menu icon in the 'WiFi' page. Then select on the right-top corner icon select Advanced > Keep WiFi on during sleep > Always.

The Android™ interface

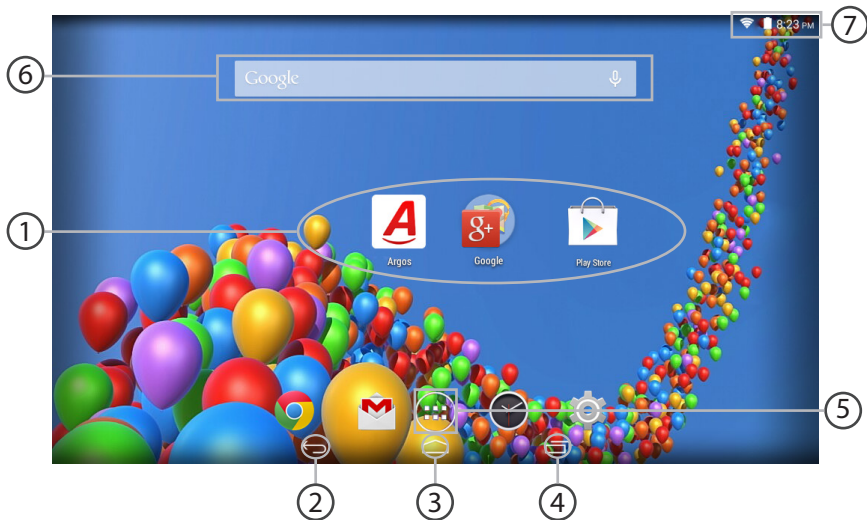

-
- ① **Android™ apps shortcuts**
> Opens an application.
 - ② **Back button**
> Goes back through the previous actions in an application (in reverse order) or out of any open application (app) if opening was the last action.
 - ③ **Home button**
> Takes you to the home screen (where you can pin shortcuts to your favourite apps).
 - ④ **Recent apps button**
> Takes you to a screen that shows thumbnail images of the apps you have open, you can then touch one to reopen it.
 - ⑤ **All Apps button**
> Shows all the applications installed on your device.
 - ⑥ **Google™ Search widget: shortcut for web search**
> Touch 'Google' for text search or touch the microphone icon for voice search.
 - ⑦ **The status bar**
> Displays notifications (emails, apps updates...). Swipe down to display quick settings.

The Android™ interface

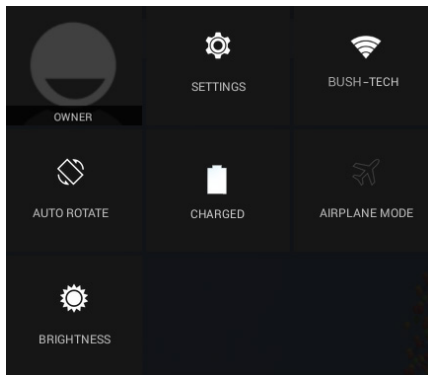

The quick settings

- Settings:
To access all your settings.
- WiFi:
To turn on/off your WiFi connection.
- Auto-rotate screen:
To activate/deactivate automatic screen orientation as you turn your tablet.
- Airplane mode:
To turn on/off all the wireless connections.
- Brightness:
To adjust the screen brightness.

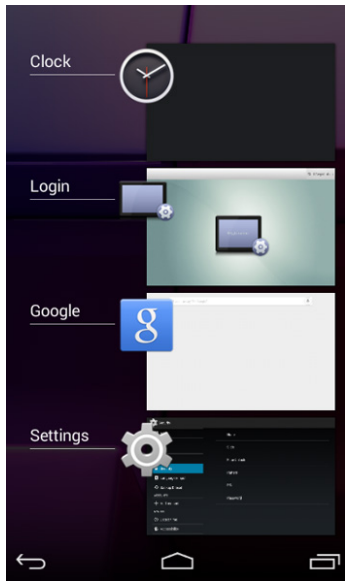

The recent apps

Opens a list of thumbnail images of apps you've worked with recently:

- To open an app, touch it.
- To close an app, swipe it left or right, or long press until 'remove from list' appears.
- To show app details, long press until 'app info' appears.

Getting familiar with Android™

Moving a home screen icon:

Touch and hold your finger onto it until the positioning gridlines appear, then slide it to the desired location, and release your finger.

Removing a home screen icon:

Touch and hold it, slide your finger towards the top of the screen and drop it over the 'Remove' icon.

Uninstalling an application:

You can only uninstall downloaded third-party applications, applications built into the firmware such as some Google apps (e.g. clock, calculator, settings etc.) cannot be deleted but some may be disabled in 'Settings'.

Apps downloaded during the initial set up or afterwards may be deleted to free up memory space.

From the 'All apps' screens, touch and hold the app icon, slide your finger towards the top of the screen and drop it over 'Uninstall' bin.

To check which applications are downloaded or built-in, go to 'Settings' then 'Apps'. You can also uninstall apps in 'Settings' and move them from internal memory to SD card etc..

Creating application folders:

Drop one app icon over another on the home screen and the two icons will be combined.

Widgets:

Hold your finger on the home screen at an empty location, then touch 'Widgets' and choose from the list.

Changing your wallpaper:

Hold your finger on the home screen at an empty location, then touch 'Wallpapers' and choose from the list.

Locking the touchscreen:

From the quick settings dashboard in the status bar, touch 'Settings'. In 'Settings', scroll down and touch 'Security'. Touch 'Screen lock'. Touch the type of lock you would like to use. After you set a lock, a lock screen is displayed whenever your screen wakes up, requesting the pattern, pin or other specified key.

Getting familiar with Android™

Downloading new apps:

To download new apps for your tablet touch the Google Play Store icon.

There you will find over 1 million apps including many which are free. Even if you only use free apps you will still need to create a Google account but you don't need to enter your credit card details to do this.

Transferring files to your tablet:

From a computer, use the USB lead provided in the package box.

From a USB device with a standard male USB connection, you will need to purchase a female USB to micro USB lead in order to connect it (e.g. USB card reader, USB connection from a camera etc.).

Via e-mail, simply add attachments to e-mail messages and send to your Google e-mail address. Then open Gmail, open the message and save the file from e-mail to your tablet memory.

Syncing your photos on your tablet and smartphone:



Photos

On your tablet:

1. Make sure that you are connected to a WiFi network.
2. Go to 'Settings'. Under Accounts/Google, touch your Google email address and verify 'Google Photos' are checked to sync.
 - If your Google account has not been set up yet, choose 'Add account' and proceed to set up an existing or create a new one.
 - At the last set up step, choose 'Keep this tablet backed up with my Google account' and all your data will be backed up.
3. After setting up your account, open 'Photos' app.
 - Sign into your Google account.
 - In the app Settings, turn on 'Auto Back up'.

On your phone, repeat process.

Your photos will be automatically uploaded to your Google+ private album online.

Troubleshooting

If your device is frozen:

Press the ON/OFF button for at least 10 seconds to reset.

If your device doesn't turn on:

Charge your device then switch on normally.

If this does not work, press the ON/OFF button for at least 10 seconds to reset.

If you want to extend the life of your battery:

Decrease the screen brightness and turn off the wireless connections if not in use.

If your device is functioning too slowly:

Close all apps which are not currently being used.

If your WiFi reception is poor:

Make sure you are not far from the WiFi hotspot.

Update the firmware of the device.

Reset and redefine your connection parameters.

Contact your WiFi connection provider.

If you want to restore your product (erase all your settings? forgotten password?) :

If your device is turned on:

1. Go to 'Settings', under 'Personal', go to 'Backup & reset'
2. Choose 'Factory data reset', then 'Reset tablet': this will erase all your settings and applications.

3. When you restart your tablet it will open the Startup wizard again, follow the onscreen instructions (see page 7). The wizard will not download the free apps that were downloaded the first time you did this but most of these are available for free from Google Play Store.

If you device doesn't turn on:

1. Hold the ON/OFF button and Volume+ button until the green robot ANDROID is displayed, then release. The Android system recovery is displayed. If you want to exit the recovery system without selecting any action, hold the ON/OFF button until the device is turned off.
2. Use the Volume buttons to scroll down to 'wipe data/factory reset and the ON/OFF button to validate the choosen action. This will erase all your settings and applications.

The User guide can also be viewed as a pdf file on the device, to open locate the pdf file in the 'files' folder on the device and touch to open.

NOTE: you may need to install a pdf viewer in order to open this file.

Helpline number: 0207 744 0346

National restrictions

This device is intended for home and office use in all EU countries (and other countries following the EU directive 1999/5/EC) without any limitation except for the countries mentioned below:

Country	Restriction	Reason/remark
Bulgaria	None	General authorization required for outdoor use and public service
France	Outdoor use limited to 10 mW e.i.r.p. within the band 2454-2483.5 MHz	Military Radiolocation use. Refarming of the 2.4 GHz band has been ongoing in recent years to allow current relaxed regulation. Full implementation planned 2012
Italy	None	If used outside of own premises, general authorization is required.
Luxembourg	None	General authorization required for network and service supply (not for spectrum)
Norway	Implemented	This subsection does not apply for the geographical area within a radius of 20 km from the centre of Ny-Alesund
Russian Federation	None	Only for indoor applications

Note: Frequency 2454-2483.5MHZ are restricted to indoor use in France.

Argos declares that this device is in compliance with the essential requirements and other relevant provisions of Directive 1999/5/EC.

CE 0700

www.argos.co.uk

All brands and product names are registered trademarks and the property of their respective owners. Windows Media® and Windows® are trademarks or registered trademarks of Microsoft Corporation in the United States and/or other countries. Google, Google Play, Android and other marks are trademarks of Google Inc. Use of this trademark is subject to Google Permissions. Specifications are subject to change without notice. Errors or omissions excepted. Images and illustrations may not always match contents. All the information contained in this guide was correct at the time of publication.

Argos Limited © 2014. All rights reserved.

PN: 113008V3