

QUICK GUIDE

50HYT62U

Please read this quick guide fully before installing or operating because it contains important setup information and keep for future reference.

For any help concerning set up and use of your TV please call the Customer Helpline:
0845 604 0105

Lines open: 9am - 8pm Monday to Saturday and 10am - 4pm Sunday

IMPORTANT - If placing TV into cabinet or alcove, ensure there is at least a 100mm (10cm) gap to the sides, rear and top of the TV. This is to allow for adequate ventilation during operation. Please read the main Users Guide for more safety information before installation.

1

insert the batteries into your handset

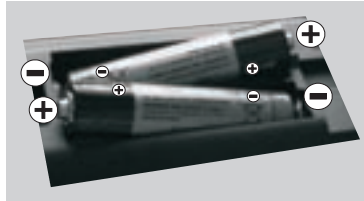

2a

either connect the aerial straight to your TV...

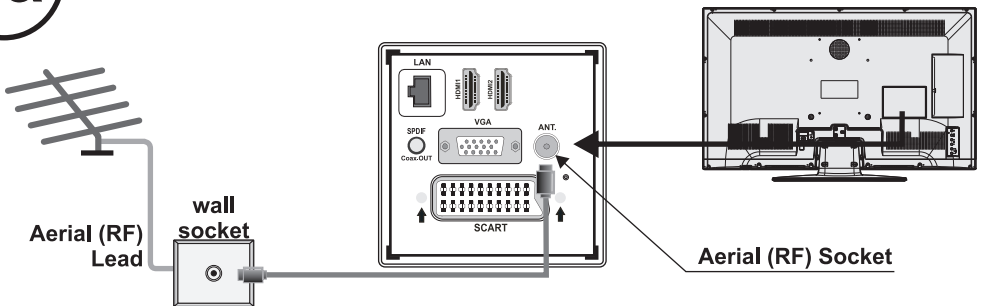

2b

...or connect the aerial through a VCR...

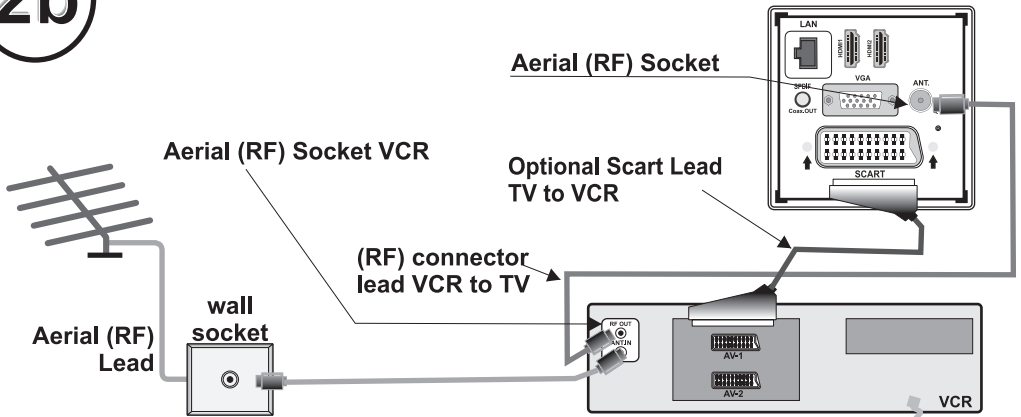

• It is recommended that a scart lead should be fitted between your TV and VCR to enhance your picture and sound quality. Scart leads are essential if you have a stereo TV and VCR and wish to obtain stereo sound from your equipment. These leads can be purchased from your Hitachi dealer or any good High Street electrical retailer.

2c

...or through a HDMI and YPbPr products (DVD-RW)

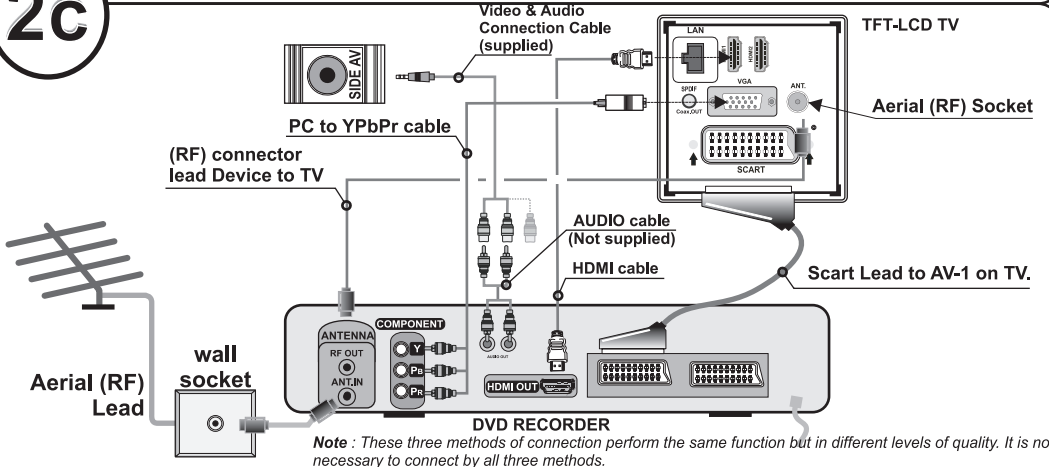

• High Definition

Your LCD Television is capable of displaying High Definition pictures from devices such as a High Definition Satellite Receiver or DVD Device. These devices must be connected via the HDMI socket or Component Socket.

2d

...or through a VCR and satellite decoder.

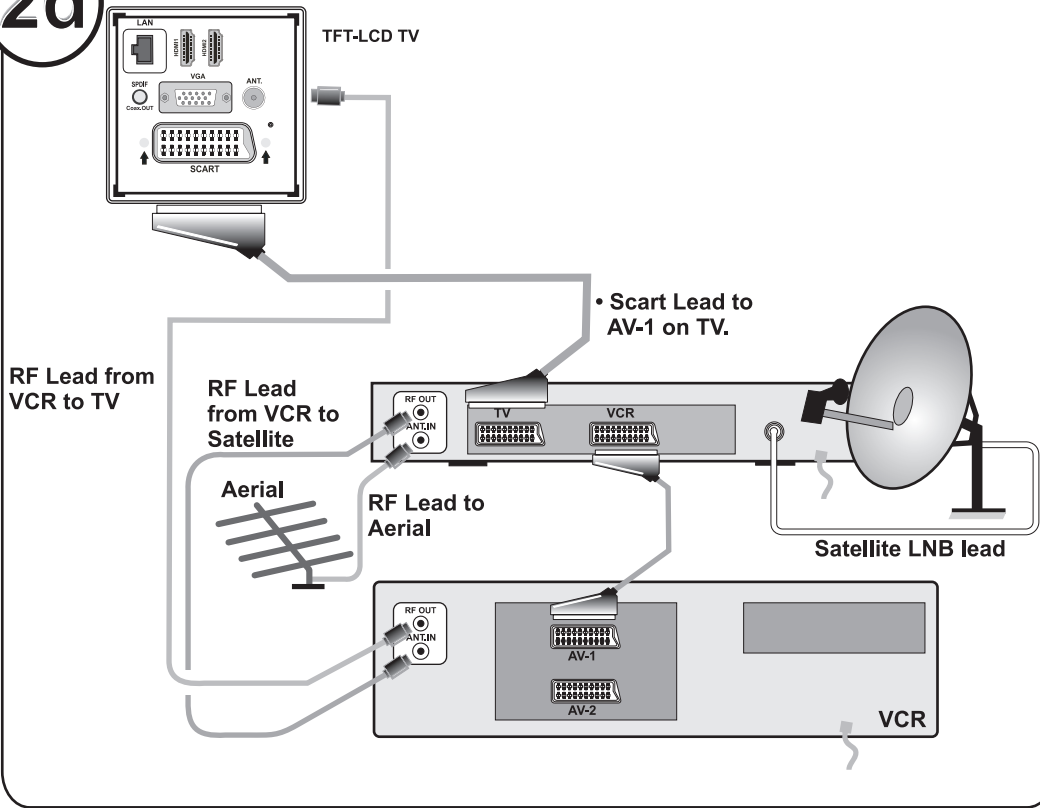

3

connect the TV plug to the mains socket

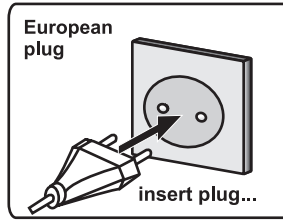
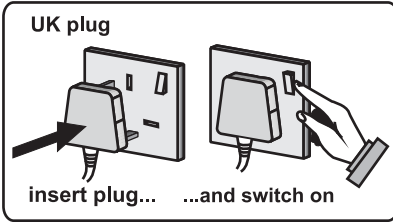

4

Press the OPERATE/STANDBY button on the remote control or press the control switch, located on the left side of the TV. The TV will then switch on.

Rear view



1. Up direction
2. Down direction
3. Programme/Volume/Av/Standby-on selection switch

NB: When the set is first switched on, the set will be in standby. Press the "O" button, P+ P- /or a numeric button on the remote control.

basic functions of remote control

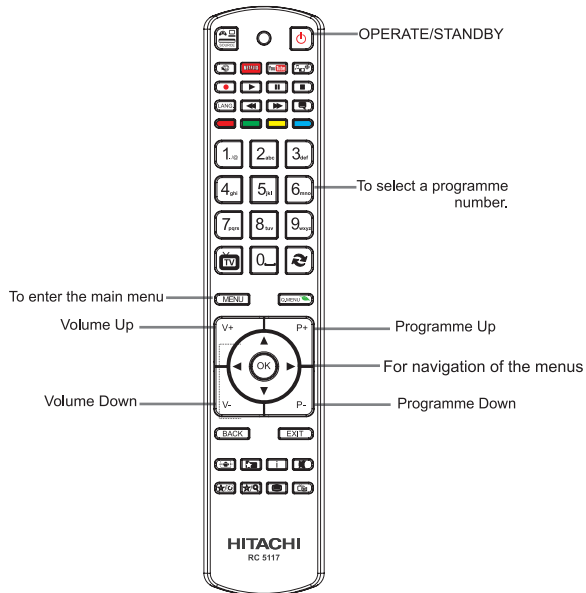

5

start A.P.S. (Auto Programming System)

1

When the TV is operated for the first time, installation wizard will guide you through the process. First, language selection screen will be displayed.

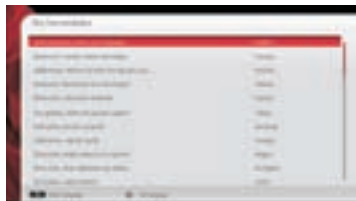

2

- Use "up" or "down" buttons to select your language and press OK button to set selected language and continue.
- After selecting the language, "First Time Installation" screen will be displayed, requiring you to set Country, Search Type, Teletext Language and Scan Encrypted options.



3

- By pressing "left" or "right" button, select the country you want to set press "down" button to highlight Search Type option. Use Left or Right button to set the desired Search Type. Available search types are digital only, analog TV only and full. When set, press Down button to highlight Teletext Language. Use "left" or "right" button to select desired Teletext Language.
- Press "down" button after setting Teletext Language option. Scan Encrypted will be then highlighted. You can set Scan Encrypted as Yes if you want to scan coded stations.
- Press OK button on the remote control to continue and the next menu will be displayed on the screen.
- You can activate Store mode option by using "left" or "right" button. If Store Mode is selected, Store mode option will be available in other settings menu and your TV's features will be illustrated on the top of the screen. A confirmation screen will be displayed after selecting the Store Mode. Select YES to proceed.
- If Home Mode is selected, Store mode will not be available after the First Time Installation. Press OK button on the remote control to Continue and the "Do you want to start an automatic channel scan?" message will be displayed on the screen.
- Select "Yes" and press the OK button to continue. Digital Search Type screen will be displayed.

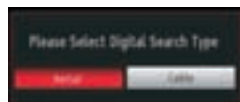
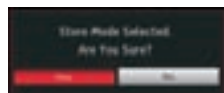
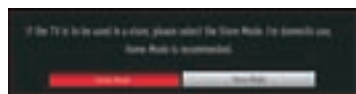

4

Please select Aerial option and press **OK** button to continue, a message asking for the starting process appears on the screen. To continue please select **YES** and press **OK**. To cancel operation, select **NO** and press **OK**. The following options will be displayed after selecting YES:



5

Note: As the Cable feature is not supported in the UK, please ensure that you select Aerial during the First Time Installation. If you mistakenly select Cable, please repeat the First Time Installation (which can be selected from the tuning menu) and select Aerial.

important note.

Once the TV has found all your local stations, they are then automatically assigned a programme number and name, if available from the broadcast.



50277043