

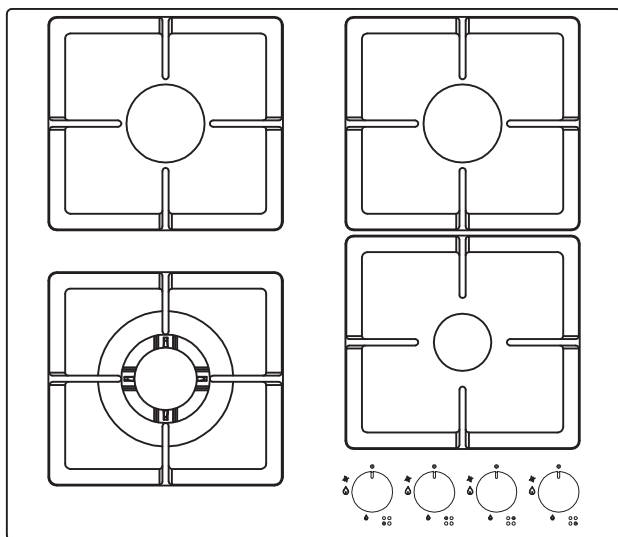

newWORLD

60cm Built in Gas Hob

Model: NWLEG60
NWLE60S



WARNING: Read the instructions before using the appliance.

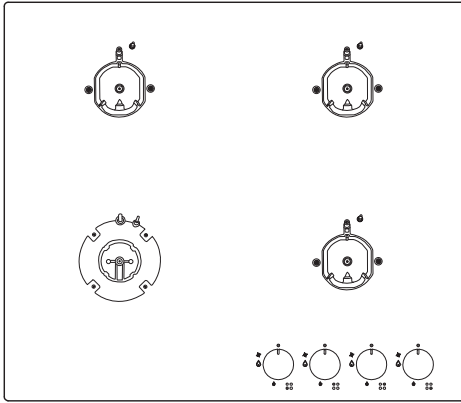

[01] x 1
hob

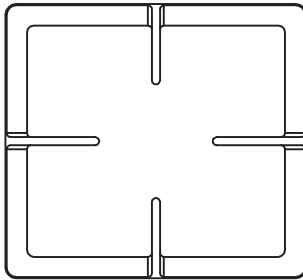

[05] x 4
pan support



[06] x 1
tape



[07] x 4
bracket

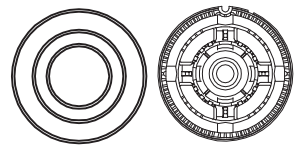

[02] x 1
triple ring burner

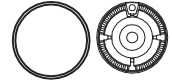

[03] x 2
semi-rapid burners



[04] x 1
auxiliary burners

1 : 1

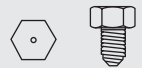



[08] x 4
LPG nozzle



[9] x 4 (4x20mm)
screws

Let's get started...

These instructions are for your safety. Please read through them thoroughly before use and retain them for future reference.

	Getting started...	
	Your product	04
	Before you start	04
	Safety	05
	In more detail...	
	Operation	09
	Care and maintenance	12
	Troubleshooting	13
	Recycling and disposal	13
	Technical and legal information	14
	Appendix...	
	Installation	20
	Guarantee	23

Your product Before you start

Your product

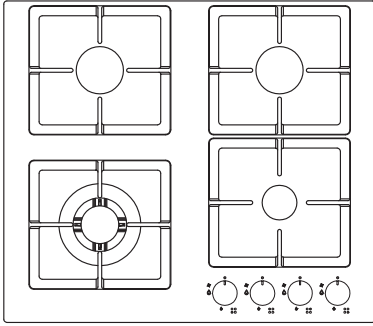

Installation guide
located at the end of
the guidebook

You will need

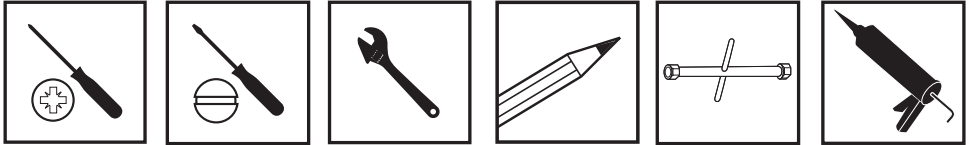

- ✓ **Important** - Please read these instructions fully before installing or operating

INSTALLATION WARNINGS

- ✓ **IMPORTANT:** This product **MUST** be installed by a qualified Gas Safe registered installer in accordance with local regulations. Particular attention should be given to the ventilation requirements.
- ✓ **IMPORTANT:** Prior to Installation ensure that the local supply conditions (electricity voltage and frequency) are compatible with the requirements of your hob.
- ✓ **IMPORTANT:** Carefully unpack and examine the appliance for any damage. If you think there is a defect, do not use the appliance and contact Product Support on 0333 305 2263. Packaging materials should be collected together and disposed immediately as they may be harmful to children.

- ✓ **IMPORTANT:** Keep the electrical cable of your gas hob away from the hot areas of your cooker, sharp edges and heated surfaces.
- ✓ **IMPORTANT:** Ensure that the electric supply cable is not trapped or damaged during installation.
- ✓ **IMPORTANT:** In the event that the cable connecting your gas hob becomes damaged, it must be replaced by a suitably qualified person. This cable must not be replaced by an unauthorised person.
- ✓ **IMPORTANT:** Protect your gas hob against atmospheric effects. Do not expose your gas hob to effects such as sun, rain, snow etc.
- ✓ **IMPORTANT:** The materials surrounding the appliance (cabinets) must be able to withstand a minimum temperature of 100°C.
- ✓ **WARNING:** Before obtaining access to terminals, all supply circuits must be disconnected.

DURING USAGE

- ✓ **IMPORTANT:** This appliance can be used by children aged from 8 years and above and persons with reduced physical, sensory or mental capabilities or lack of experience and knowledge if they have been given supervision or instruction concerning use of the appliance in a safe way and understand the hazards involved. Children shall not play with the appliance. Cleaning and user maintenance shall not be made by children without supervision.

- ✓ **WARNING:** The appliance and its accessible parts become hot during use. Care should be taken to avoid touching heating elements. Children less than 8 years of age shall be kept away unless continuously supervised.

- ✓ **WARNING:** Cooking on a hob with fat or oil can be dangerous and should not be left unattended.

WARNING: NEVER try to extinguish a cooking fire with water. Instead switch off the appliance

and cover flame e.g. with a lid or a fire blanket.

- CAUTION:** Do not allow children in the kitchen when cooking or while hob parts may still be hot. Many parts of the hob will become hot and present a considerable hazard to children.
- CAUTION:** Before starting to use your appliance, ensure curtains, paper or flammable items are kept away from your appliance. Do not keep flammable materials inside of or around your gas hob.
- WARNING:** If the surface is cracked, switch off the appliance to avoid the possibility of electric shock.

Product functions

- 4 x burners: Four zones of cooking.
- Flame safety device (FSD): Stops the gas supply to the gas hob when the flame goes out
- Auto ignition.
- LPG conversion kit supplied.

Control elements

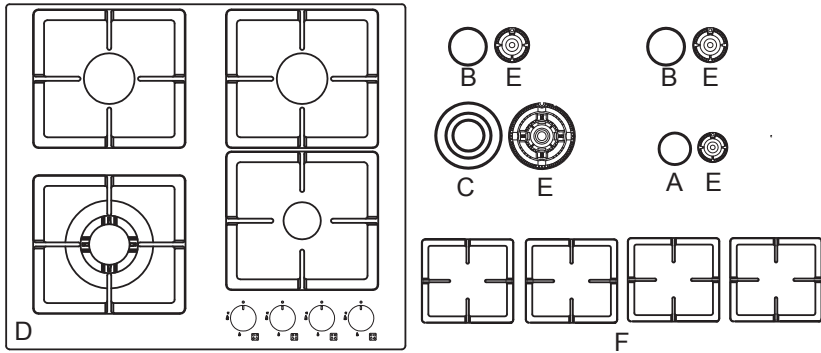

Operation

Control elements

Reference	Description	Qty
A	Auxiliary burner	1
B	Semi-rapid burner	2
C	Triple ring burner	1
D	Panel	1
E	Burner caps	4
F	Pan support	4

Note: This diagram may be slightly different from the layout of the appliance.

Operation

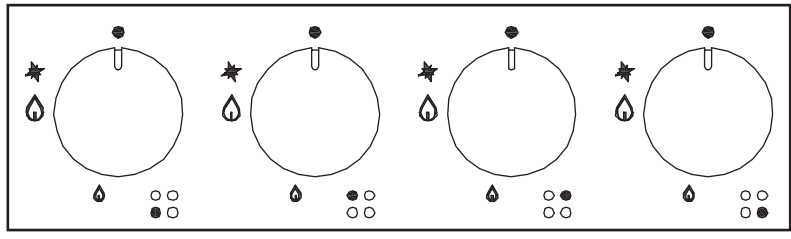

Use of the burners



Caution

- If there is no electric current you can light the burners with piezo electric spark gas ignitor.
- The burners can only be lit with safety thermocouples when the knob is on **MAXIMUM**.
- If ignition is failed for the first time, then we should wait for 5 minutes before we try again.

On the right bottom side of each knob on the control panel there is a diagram to indicate the burner to which the knob refers to. The burners can be switched on in several ways, according to the type of appliance and its individual features.

Operation

Manual "ON" switch (this is always possible even if the electric current is off):

- Turn the knob corresponding to the selected burner in a counter-clockwise direction so that the knob is at MAXIMUM (this corresponds to a large flame)
- Use a piezo electric spark gas ignitor.

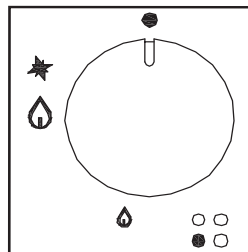

Automatic electric "ON" switch for burners with safety device (thermocouples):

- Turn the knob corresponding to the selected burner in a counter-clockwise direction so that the knob is at MAXIMUM.
- Once the burner is lit, keep the knob pressed in for about 10 seconds in order to allow the flame to heat up the thermocouple. If the burner goes out when the knob is let go, repeat the operation.

Note



- The use of a gas cooking appliance produces heat and humidity in the place where it is installed.
- Therefore, you need to ensure the place is well ventilated, keeping the natural ventilation openings clear and using a mechanical ventilation device/ flue or electric fan
- Intensive or prolonged use of the appliance may require additional ventilation, such as opening a nearby window or increased ventilation efficiency obtained by increasing the power of the mechanical ventilators, where applicable.

Advice for the best use of the burner:

- When boiling point is reached, turn the knob to MINIMUM.
- Always use pans with a lid.

Burner	Recommended pan diameters (cm)
Auxiliary	8-16
Semi-rapid	12-20
Triple ring	22-26

Care and maintenance



Warning

Always switch off the electricity supply before performing maintenance work. In the event of a fault, contact customer services on 0333 305 2263.

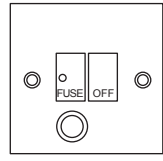

Caution

- Use soapy water and a cloth for cleaning. Never use abrasive powders.
- Avoid banging pots and pans down on the hob.
- Do not leave any empty pan on the heating zone.

- The appliance should be cleaned after use.
- Wipe the inner and outer surface of the appliance and its accessories with a wet cloth.
- Any liquid overflowing from the pan must always be removed with a cloth
- The surface of the hob may be easily cleaned as follows:

Cleaning of enamel parts:

To maintain the features of the enamel parts, wash frequently with soapy water. Never use abrasive powders. Avoid leaving acid or alkaline substances on the enamel parts (vinegar, lemon juice, salt, tomato juice, etc. and washing the enamel parts while they are still warm.

Cleaning of stainless steel parts:

Wash these parts with soapy water and then dry them with a soft cloth. The shine is maintained by regularly cleaning them with special products normally commercially available. Never use abrasive powders.

Cleaning of burner flame dividers:

Given that they are not fixed, the flame dividers can be cleaned by simply removing them and washing them with soapy water. After drying them well and checking that the holes are not blocked, put them back into their correct position.

Replacement of parts

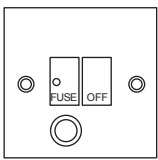

Warning

Always switch off the electricity supply before performing maintenance work. In the event of a fault, contact customer services on 0333 305 2263.

Troubleshooting

The following circumstances may not be a problem. Do not contact the customer services until the problem has been confirmed.

If your appliance is still not functioning properly after making the below checks, please contact customer services.

1. Check that the mains supply has not been switched off.
2. Check that the fuse in the spur has not blown.
3. Ensure that the burner components are not excessively soiled as this can lead to ignition problems.

Do not take the appliance apart yourself, as you may damage the hob.

Before calling After Sales Service, please do the following:

1. Check that the appliance is correctly connected.
2. Read the failure text above. If you are still unable to solve the problem, switch off the appliance, do not try to take it apart and call customer services.

If the supply cord is damaged, it must be replaced by the manufacturer, its service agent or similarly qualified persons in order to avoid a hazard.

Recycling and disposal

Environmental protection

Waste electrical products should not be disposed of with household waste. Please recycle where facilities exist. Check with your Local Authority or retailer for recycling advice.



The symbol on the product or its packaging indicates that this product cannot be treated as normal household waste. This product must be handed over to an electric and electronic equipment collection point for recycling.

On ensuring that this product is disposed of correctly, you will help to avoid possible negative consequences for the environment and public health, which could occur if this product is not handled correctly. To receive more detailed information about recycling this product, contact your local government, domestic waste disposal services or the outlet where the product was bought.

Technical specification

Supply voltage	220-240V~, 50/60Hz
Gas pressure	G20 type/ 20mbar/ 8.3kW G30 type/ 28-30mbar/ 8.3kW
External dimensions (W x H x D)	590x83x510mm
Net weight	NWLEG60 14.6kg NWLE60S 10.6kg

USER CHARACTERISTICS

BURNER TYPE	MAX OUTPUT	MIN OUTPUT	G20 20mbar		G30 28-30mbar	
	Kw	Kw	Nozzle size (mm)	Cons M³/h	Nozzle size (mm)	Cons g/h
Small Auxiliary burner	1.00	0.35	0.72	0.095	0.50	73
Medium Semi-rapid Burner	1.75	0.65	0.97	0.167	0.65	127
Triple flam burner	3.80	1.9	1.35	0.362	0.98	276

Energy fiche

	Symbol	Value	Unit
Brand	-	 newWORLD	-
Model identification	-	NWLEG60 NWLE60S	-
Type of hob	-	Gas hob	-
Number of gas burners	-	4	-
Energy efficiency per gas burner	EE gas burner	Triple ring burner: 60.87% Semi-rapid burner-1: 59.73% Semi-rapid burner-2: 59.49% Auxiliary burner: N.A.	
Energy efficiency for the gas hob	EE gas hob	60.03%	

Wiring

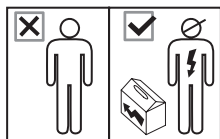

All installation work must be carried out by a competent person or qualified electrician
 Before connecting the mains supply ensure that the mains voltage corresponds to the voltage on the rating plate on your hob.



WARNING: THIS APPLIANCE MUST BE EARTHED.

Mains Supply could be connected to the Mains Voltage by Direct Connection

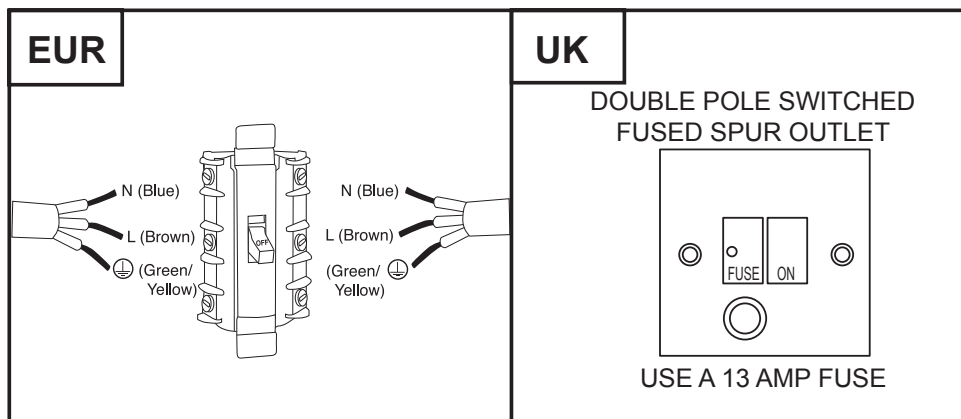

Direct Connection

If the appliance is being connected directly to the mains an omnipolar circuit-breaker must be installed with a minimum opening of 3mm between contacts.

The installer must ensure that the correct electrical connection has been made and that it complies with the wiring diagram.

The cable must not be bent or compressed.

Regularly check the power plug and power cord for damage. If the supply cord is damaged, it must be replaced by a special cord or assembly available from the manufacturer or its service agent.

Technical and legal information

The Manufacturer declines all liability for damage caused to persons and objects due to incorrect or improper installation of the appliance.

Electrical Requirements

Any permanent electrical installation must comply with the latest I.E.E. Regulations and local electricity company regulations. For your own safety a qualified electrician or contractor who is on the roll of the National Inspection Council for Electrical Installation Contracting (NICEIC) should undertake the electrical installation.

Electrical Connection

Before connecting the mains supply ensure that the mains voltage corresponds to the voltage on the rating plate inside the appliance.



WARNING: THIS APPLIANCE MUST BE EARTHED

The appliance is supplied with a 3-core mains cable and must be connected to the electricity supply via a double pole switch having a 3mm minimum contact gap on each connector.

For UK only

A Switched Fused Connection Unit to BS 1363 Part 4 is recommended.

The fuse must be rated at 13 Amps.

The wires in the mains lead are coloured in accordance with the following code:

Brown = L - Live

Blue = N - Neutral

Green/Yellow = ⊕ - Earth

The connection point must be placed in a position adjacent to the appliance so as to be readily accessible for an engineer in the event of a breakdown.

Installation guidelines

Gas supply requirements

The appliance installation must be carried out in accordance with relevant local regulations.

The installation must be carried out by an authorised gas appliance installer and tested to local regulations.

We are not legally able to offer advice on the installation of gas appliances to unauthorised personnel.

Ventilation

All rooms require a window or equivalent (e.g. a door which can be opened). Some rooms require a permanent vent or extractor in addition to a window (see below).

This unit must not be used in a room which is less than 5m³. The following table details the requirements based on the kitchen volume (L x W x H) in m³.

The above requirements also allow use of a gas oven and grill but if there are any other fuel burning appliances in the same room, consult the relevant British Standard (BS5440) or Gas Safe manual.

Room Volume (m ³)	Air vent required (cm ³)
5	100
6 to 10	50
6 to 11	No permanent vent required if a door opens to the outside
11 or more	None required

The above requirements also allow use of a gas oven and grill but if there are any other fuel burning appliances in the same room, consult the relevant British Standard (BS440) or Gas Safe document.

Gas connection



Caution

The gas connection must be installed in compliance with applicable regulations in the country of installation.

The preferred method of connection is by rigid copper pipe or by flexible hose depending on local regulations. The hob is supplied with a G $\frac{1}{2}$ " elbow that can be used or discarded depending on approved method of connection and best engineering practice.

Changing the nozzles



Caution

The hob installation and burner changes must be carried out by a competent person, e.g. a gas safe registered fitter.



Note

The LPG nozzles are provided in a separate bag marked "LPG" and if they are changed and the natural gas jets retained then the label should be changed to "NATURAL".

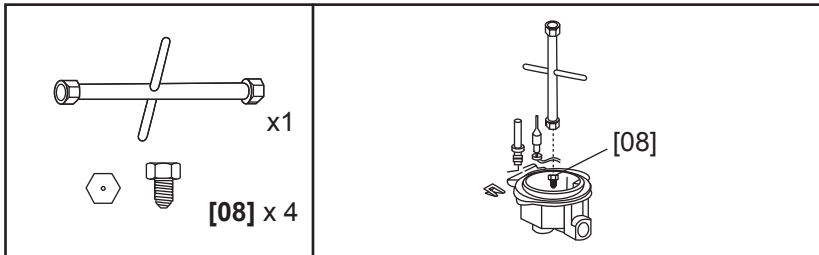

Lift up the burners and unscrew the nozzle using a dedicated tool and replace the nozzles with those designed for LPG gas supply.

Gas connection

Regulation of burners



Caution

The regulation described can only be carried out with burners that use methane gas and city gas (where available), whereas the screw must be fully tightened in a clockwise direction on burners using liquid gas.

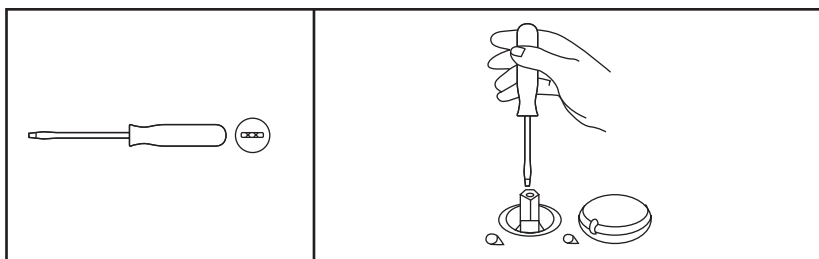

Regulation of the "MINIMUM" position on the burners.

To regulate the minimum position on the burners, follow the procedure below:

1. Turn on the burner and turn the knob to its MINIMUM position (small flame)
2. Remove the knob from the tap set for standard pressure. The knob is found on the bar of the tap itself.
3. Use a small screwdriver that fits the (gold) screws located at the lower part of the tap and turn the fixing screw to the right or left until the flame of the burner is regulated in the most suitable manner to MINIMUM.
4. Make sure that the flame does not go out when changing the position quickly from MAXIMUM to MINIMUM position.



Caution

Customers or unqualified persons should not adjust "Minimum" position on the burner by themselves. It can only be adjusted by a qualified technician according to relative standard.

Clearance



Warning

Good ventilation is required around the appliance for easier dissipation of heat and low power consumption.

Sufficient clearance is required around the appliance.

The gap between the hob and any cooker hood above it should be at least 750mm.

The gap between the hob and any adjacent wall cabinet above should be at least 450mm.

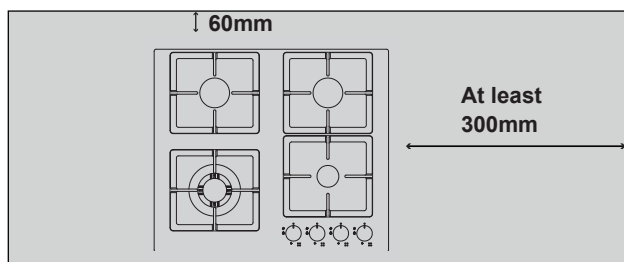
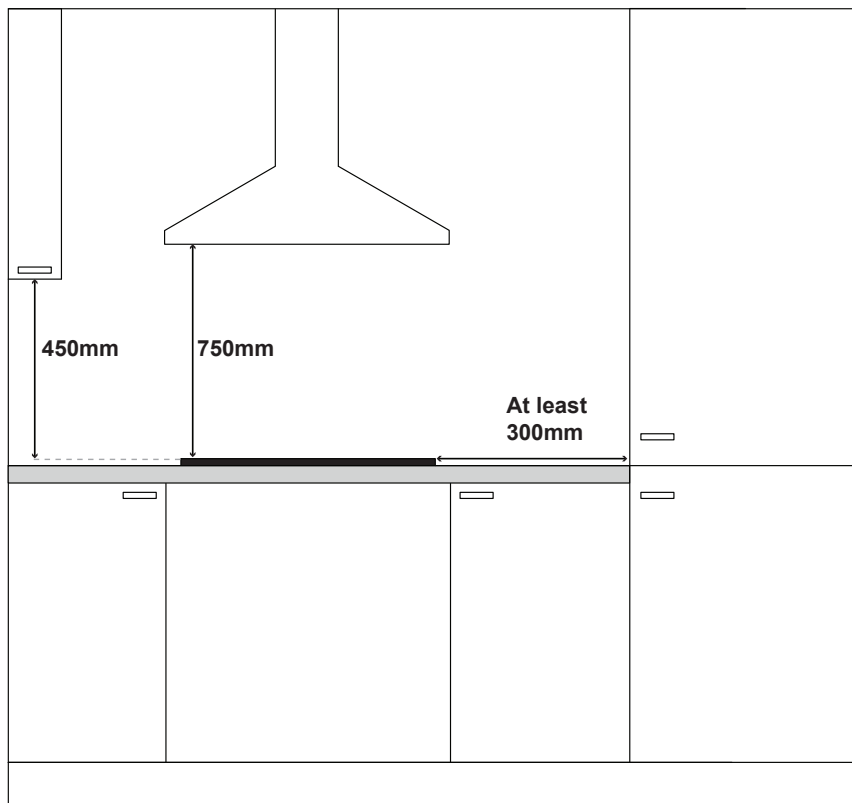

01

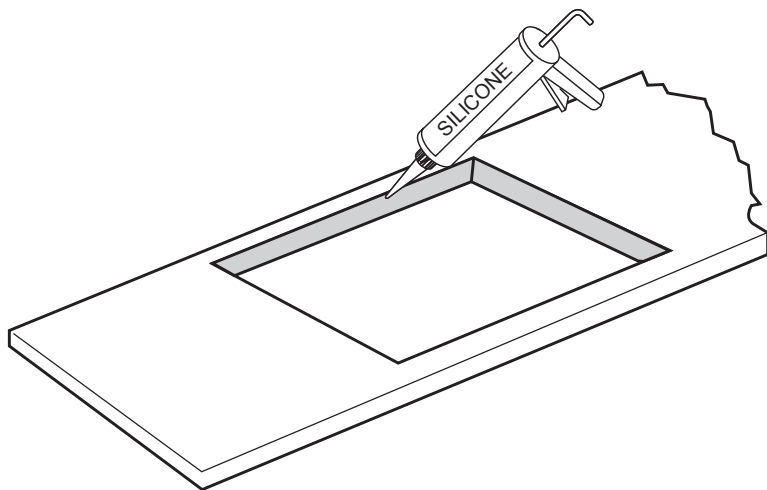

Cut out worktop at 560*490mm with suitable equipment and seal the cut edge with appropriate sealant

02



[06] x 1

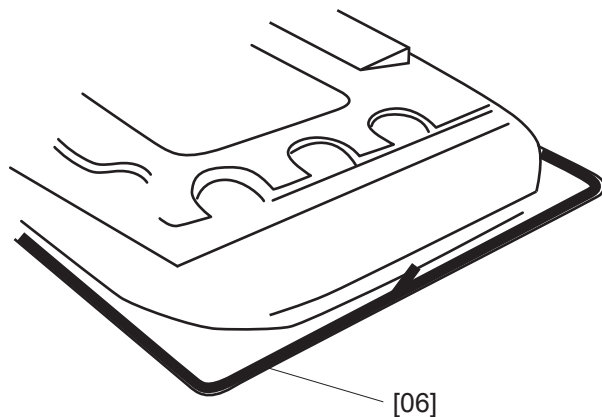

[06]

Stretch out the supplied seal along the underside edge of the hob, ensuring the ends overlap.

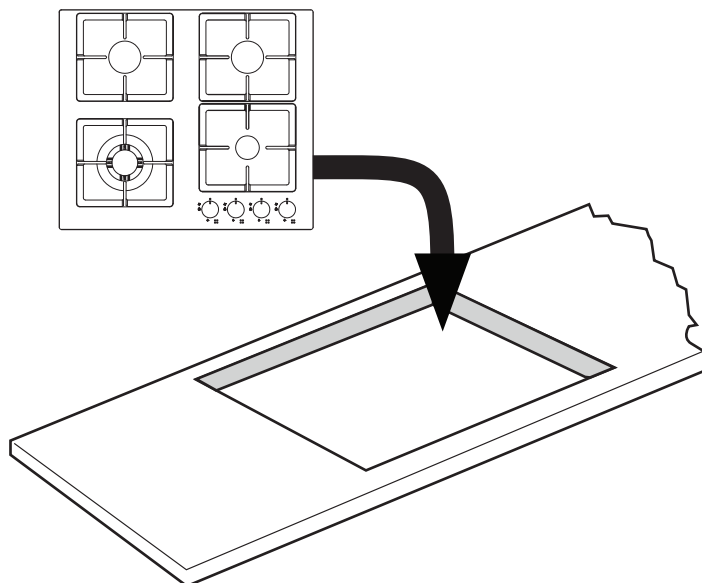

Place the hob into position and secure with brackets as shown in Fig 1.

Fig 1

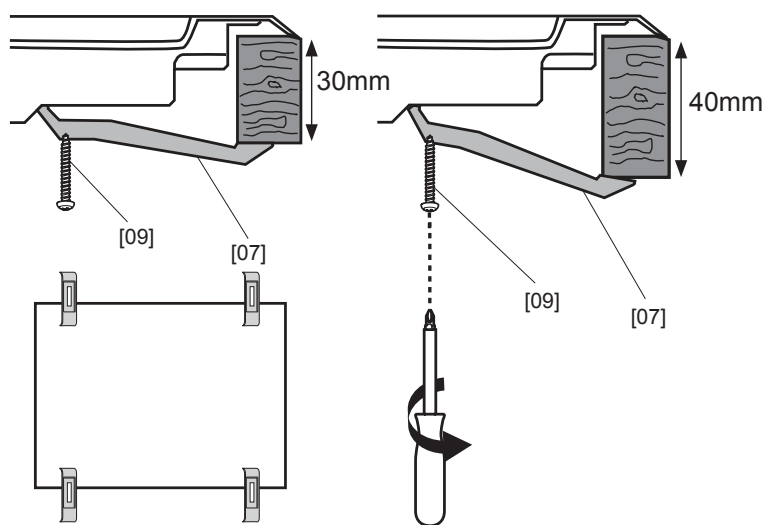

[07] x 4



[09] x 4

Note: For electrical connection see *Technical and legal information* section.

Help and assistance

If you require any technical guidance or find that your washing machine is not operating as intended, a simple solution can often be found in the **Troubleshooting** section of these instructions or online at www.newworldassist.co.uk

If you still require further assistance, call one of our experts on **0333 3052263***. To help give us give you a fast and efficient service please have the following information ready:

Model Ref.

You can find these on the rating plate - a small information panel (usually a sticker or metal plate) on the rear of your appliance

Serial number

Date of purchase

This will be shown on your receipt

Local call rates applies*

Lines open 09:00- 17:30 Monday to Friday.

*Calls to New World enquiry lines may attract a charge and set up fee from residential lines depending on your call plan/tariff. Mobile and other providers costs may vary, see www.bt.com/pricing for details.

For Security and training purposes, telephone calls to and from customer service centres maybe recorded and monitored. Calls from Republic of Ireland will attract international call charges.

Product support

Help is always at hand



Call us now and activate your 24 month guarantee

Thank you for choosing New World. Your new product is guaranteed against faults and breakdowns for 24 months. Don't forget to register it with us today so we can provide you with our best possible after-sales service and useful updates.

www.newworldassist.co.uk

0333 305 2263

Your New World Guarantee

This product is guaranteed for 24 months from the date of original purchase. Any defect that arises due to faulty materials or workmanship will be repaired free of charge (or if applicable the product will be replaced or the purchase price refunded) where possible during this period by the dealer from who your purchased the unit.

The guarantee is subject to the following provisions:

- The guarantee does not cover accidental damage, misuse, cabinet parts, knobs or consumable items.
- The product must be correctly installed and operated in accordance with the instructions contained in the manual.
- It must be used solely for domestic purposes. The guarantee will be rendered invalid if the product is re-sold or has been damaged by inexpert repair.
- Specifications are subject to change without notice.
- New World disclaim any liability for loss or damage arising from the breakdown of the product.
- This guarantee is in addition to and does not diminish your statutory or legal rights.

Important Data Protection Information

To find out how we use your data please refer to the guarantee registration material or visit www.newworldassist.co.uk



newWORLD

Contact:

www.newworldassist.co.uk

Helpline: 0333 305 2263

52292964