

Panasonic®

OPERATING INSTRUCTIONS

TX-39GS352B

LED TV

e-MANUAL

You can find instructions for your TV's features in the **E-Manual**. To access the **E-Manual**, enter **Settings** menu, select **Manuals** and press **OK**. For quick access press **Home/Menu** button and then **Info** button.

Contents

Safety Information	2	Subtitle File Formats.....	25
Markings on the Product.....	2	Supported DVI Resolutions	25
Maintenance.....	4	Connectivity.....	26
Display panel, Cabinet, Pedestal.....	4	Wired Connectivity.....	26
Mains plug.....	4	Wireless Connectivity	26
Assembling / Removing the pedestal	4	Handling of the customer information.....	27
When using the wall-hanging bracket.....	5	Wake ON	27
Environmental Information.....	5	Connectivity Troubleshooting	28
Features	5	Using Audio Video Sharing Network Service.....	28
Accessories Included.....	6	Apps	29
Standby Notifications.....	6	Freeview Play Platform.....	29
TV Control Switch & Operation.....	6	Internet Browser	29
Using Main TV Menu	7	HBTV System.....	30
Inserting the Batteries into the Remote	7	DVB functionality information	30
Power Connection	8	Important Instruction.....	31
Antenna Connection.....	8		
License Notification	8		
Disposal of Old Equipment and Batteries.....	8		
Declaration of Conformity (DoC)	8		
Sales and Support Information	9		
Specification	9		
Notice	10		
Remote Control	11		
Connections.....	12		
Switching On/Off.....	13		
First Time Installation.....	13		
Media Playback via USB Input	14		
Media Browser.....	14		
CEC	15		
Settings Menu Contents	16		
General TV Operation	21		
Using the Channel List	21		
Configuring Parental Settings.....	21		
Electronic Programme Guide	21		
Teletext Services (where available).....	22		
MHEG Teletext	22		
BBC Red Button+ (RB+).....	22		
Software Upgrade.....	22		
Troubleshooting & Tips	23		
PC Input Typical Display Modes.....	23		
AV and HDMI Signal Compatibility	23		
Supported File Formats for USB Mode	24		
Video File Formats	24		
Picture File Formats	24		
Audio File Formats	24		

Safety Information

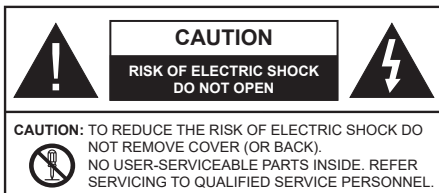

In extreme weather (storms, lightning) and long inactivity periods (going on holiday) disconnect the TV set from the mains.

The mains plug is used to disconnect TV set from the mains and therefore it must remain readily operable. If the TV set is not disconnected electrically from the mains, the device will still draw power for all situations even if the TV is in standby mode or switched off.

Note: Follow the on screen instructions for operating the related features.

IMPORTANT - Please read these instructions fully before installing or operating

WARNING: This device is intended to be used by persons (including children) who are capable / experienced of operating such a device unsupervised, unless they have been given supervision or instruction concerning the use of the device by a person responsible for their safety.

- Use this TV set at an altitude of less than 2000 meters above the sea level, in dry locations and in regions with moderate or tropical climates.
- The TV set is intended for household and similar general use but may also be used in public places.
- For ventilation purposes, leave at least 5cm of free space around the TV.
- The ventilation should not be impeded by covering or blocking the ventilation openings with items, such as newspapers, table-cloths, curtains, etc.
- The power cord plug should be easily accessible. Do not place the TV, furniture, etc. on the power cord. A damaged power cord/plug can cause fire or give you an electric shock. Handle the power cord by the plug, do not unplug the TV by pulling the power cord. Never touch the power cord/plug with wet hands as this could cause a short circuit or electric shock. Never make a knot in the power cord or tie it with other cords. When damaged it must be replaced, this should only be done by qualified personnel.
- Do not expose the TV to dripping or splashing of liquids and do not place objects filled with liquids, such as vases, cups, etc. on or over the TV (e.g., on shelves above the unit).
- Do not expose the TV to direct sunlight or do not place open flames such as lit candles on the top of or near the TV.

- Do not place any heat sources such as electric heaters, radiators, etc. near the TV set.
- Do not place the TV on the floor and inclined surfaces.
- To avoid danger of suffocation, keep plastic bags out of the reach of the babies, children and domestic animals.
- Carefully attach the stand to the TV. If the stand is provided with screws, tighten the screws firmly to prevent the TV from tilting. Do not over-tighten the screws and mount the stand rubbers properly.
- Do not dispose of the batteries in fire or with hazardous or flammable materials.

WARNING

- Batteries must not be exposed to excessive heat such as sunshine, fire or the like.
- Excessive sound pressure from earphones or headphones can cause hearing loss.

ABOVE ALL - NEVER let anyone, especially children, push or hit the screen, push anything into holes, slots or any other openings in the case.

Caution	Serious injury or death risk
Risk of electric shock	Dangerous voltage risk
Maintenance	Important maintenance component

Markings on the Product

The following symbols are used on the product as a marker for restrictions and precautions and safety instructions. Each explanation shall be considered where the product bears related marking only. Note such information for security reasons.



Class II Equipment: This appliance is designed in such a way that it does not require a safety connection to electrical earth.



Hazardous Live Terminal: The marked terminal(s) is/are hazardous live under normal operating conditions.



Caution, See Operating Instructions: The marked area(s) contain(s) user replaceable coin or button cell batteries.



Class 1 Laser Product: This product contains Class 1 laser source that is safe under reasonably foreseeable conditions of operation.

WARNING

Do not ingest the battery, Chemical Burn Hazard
This product or the accessories supplied with the product may contain a coin/button cell battery. If the coin/button cell battery is swallowed, it can cause severe internal burns in just 2 hours and can lead to death.

Keep new and used batteries away from children. If the battery compartment does not close securely, stop using the product and keep it away from children.

If you think batteries might have been swallowed or placed inside any part of the body, seek immediate medical attention.



Never place a television set in unstable or inclined locations. A television set may fall, causing serious personal injury or death. Many injuries, particularly to children, can be avoided by taking simple precautions such as;

- Using cabinets or stands recommended by the manufacturer of the television set.
- Only using furniture that can safely support the television set.
- Ensuring the television set is not overhanging the edge of the supporting furniture.
- Not placing the television set on tall furniture (for example, cupboards or bookcases) without anchoring both the furniture and the television set to a suitable support.
- Not standing the television set on cloth or other materials placed between the television and supporting furniture.
- Educating children about the dangers of climbing on furniture to reach the television set or its controls. If your existing television set is being retained and relocated, the same considerations as above should be applied.



Apparatus connected to the protective earthing of the building installation through the MAINS connection or through other apparatus with a connection to protective earthing – and to a television distribution system using coaxial cable, may in some circumstances create a fire hazard. Connection to a television distribution system has therefore to be provided through a device providing electrical isolation below a certain frequency range (galvanic isolator)

WALL MOUNTING WARNINGS

- Read the instructions before mounting your TV on the wall.
- The wall mount kit is optional. You can obtain from your local dealer, if not supplied with your TV.
- Do not install the TV on a ceiling or on an inclined wall.
- Use the specified wall mounting screws and other accessories.
- Tighten the wall mounting screws firmly to prevent the TV from fall. Do not over-tighten the screws.

WARNING

- Using other wall-hanging brackets, or installing a wall-hanging bracket by yourself have the risk of personal injury and product damage. In order to maintain the unit's performance and safety, be absolutely sure to ask your dealer or a licensed contractor to secure the wall-hanging brackets. Any damage caused by installing without a qualified installer will void your warranty.
- Carefully read the instructions accompanying optional accessories, and be absolutely sure to take steps to prevent the TV from falling off.
- Handle the TV carefully during installation since subjecting it to impact or other forces may cause product damage.
- Take care when fixing wall brackets to the wall. Always ensure that there are no electrical cables or pipes in the wall before hanging bracket.
- To prevent fall and injury, remove the TV from its fixed wall position when it is no longer in use.

Figures and illustrations in this user manual are provided for reference only and may differ from the actual product appearance. Product design and specifications may be changed without notice.

Maintenance

First, remove the mains plug from the mains socket.

Display panel, Cabinet, Pedestal

Regular care:

Gently wipe the surface of the display panel, cabinet, or pedestal by using a soft cloth to remove dirt or fingerprints.

For stubborn dirt:

1. First clean the dust from the surface.
2. Dampen a soft cloth with clean water or diluted neutral detergent (1 part detergent to 100 parts water).
3. Wring out the cloth firmly. (Please note, do not let liquid enter the TV inside as it may lead to product failure.)
4. Carefully wipe moisten and wipe away the stubborn dirt.
5. Finally, wipe away all the moisture.

Caution

Do not use a hard cloth or rub the surface too hard, otherwise this may cause scratches on the surface.

- Take care not to subject the surfaces to insect repellent, solvent, thinner or other volatile substances. This may degrade surface quality or cause peeling of the paint.
- The surface of the display panel is specially treated and may be easily damaged. Take care not to tap or scratch the surface with your fingernail or other hard objects.
- Do not allow the cabinet and pedestal to make contact with a rubber or PVC substance for a long time. This may degrade surface quality.

Mains plug

Wipe the mains plug with a dry cloth at regular intervals.

Moisture and dust may cause fire or electrical shock.

Assembling / Removing the pedestal

Preparations

Take out the pedestal(s) and the TV from the packing case and put the TV onto a work table with the screen panel down on the clean and soft cloth (blanket, etc.)

- Use a flat and firm table bigger than the TV.
- Do not hold the screen panel part.
- Make sure not to scratch or break the TV.

Assembling the pedestal

1. The stand of the TV consists of two pieces. Install these pieces together.

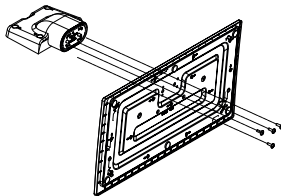

2. Place the stand(s) on the stand mounting pattern(s) on the rear side of the TV.

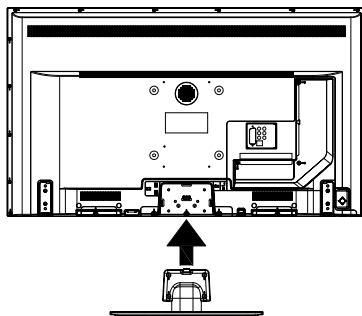

3. Insert the screws (M4 x 12) provided and tighten them gently until the stand is properly fitted.

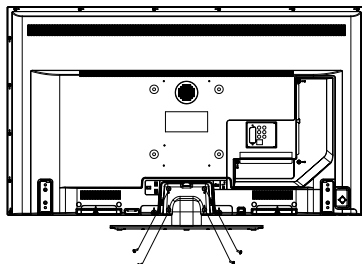

Removing the pedestal from the TV

Be sure to remove the pedestal in the following way when using the wall-hanging bracket or repacking the TV.

- Put the TV onto a work table with the screen panel down on the clean and soft cloth. Leave the stand(s) protruding over the edge of the surface.
- Unscrew the screws that fixing the stand(s).
- Remove the stand(s).

When using the wall-hanging bracket

Please contact your local Panasonic dealer to purchase the recommended wall-hanging bracket.

Holes for wall-hanging bracket installation;

Rear of the TV

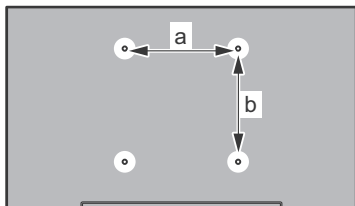

a (mm)	200
b (mm)	200

View from the side

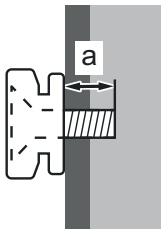

Depth of screw (a)	min. (mm)	10
	max. (mm)	13
Diameter	M6	

Note: The screws for fixing the TV onto the wall-hanging bracket are not supplied with the TV.

Environmental Information

This television is designed to be environment friendly. To reduce energy consumption, you can follow these steps:

If you set the **Energy Saving** to **Minimum**, **Medium**, **Maximum** or **Auto** the TV will reduce the energy consumption accordingly. If you like to set the **Backlight** to a fixed value set as **Custom** and adjust the **Backlight** (located under the **Energy Saving** setting) manually using Left or Right buttons on the remote. Set as **Off** to turn this setting off.

Note: Available **Energy Saving** options may differ depending on the selected **Mode** in the **Settings>Picture** menu.

The **Energy Saving** settings can be found in the **Settings>Picture** menu. Note that some picture settings will be unavailable to be changed.

If pressed Right button or Left button consecutively, **"Screen will be off in 15 seconds."** message will be displayed on the screen. Select **Proceed** and press **OK** to turn the screen off immediately. If you don't press any button, the screen will be off in 15 seconds. Press any button on the remote or on the TV to turn the screen on again.

Note: **Screen Off** option is not available if the Mode is set to **Game**.

When the TV is not in use, please switch off or disconnect the TV from the mains plug. This will also reduce energy consumption.

Features

- Remote controlled colour TV
- Fully integrated digital terrestrial/cable TV (DVB-T-T2/C)
- HDMI inputs to connect other devices with HDMI sockets
- USB input
- OSD menu system
- Back AV inputs for external devices (such as DVD Players, PVR, video games, etc.)
- Stereo sound system
- Teletext
- Headphone connection
- Automatic programming system
- Manual tuning
- Automatic power down after up to eight hours
- Sleep timer
- Child lock
- Automatic sound mute when no transmission
- NTSC playback
- AVL (Automatic Volume Limiting)
- PLL (Frequency Search)

- PC input
- Game Mode (Optional)
- Picture off function
- Ethernet (LAN) for Internet connectivity and service
- 802.11 a/b/g/n built in WLAN Support
- Audio Video Sharing
- HbbTV

Accessories Included

- Remote Control
- Batteries: 2 x AA
- Instruction Book
- Detachable stand
- Stand mounting screws (M4 x 12)

Standby Notifications

If the TV does not receive any input signal (e.g. from an aerial or HDMI source) for 3 minutes, it will go into standby. When you next switch-on, the following message will be displayed: **“TV switched to stand-by mode automatically because there was no signal for a long time.”**

The **Auto TV OFF** option (in the **Settings>System>More** menu) could have been set to a value between 1 and 8 hours by default. If this setting is not set as **Off** and the TV has been left on and not been operated during the set time, it will switch into standby mode after the set time has expired. When you next switch-on the TV, the following message will be displayed. **“TV switched to stand-by mode automatically because no operation was made for a long time.”** Before the TV switches into standby mode a dialogue window will be displayed. If you do not press any button the TV will switch into the standby mode after a waiting period of about 5 minutes. You can highlight **Yes** and press **OK** to switch the TV into standby mode immediately. If you highlight **No** and press **OK**, the TV will remain on. You can also choose to cancel the **Auto TV OFF** function from this dialogue. Highlight **Disable** and press **OK**, the TV will remain on and the function will be cancelled. You can enable this function again by changing the setting of the **Auto TV OFF** option from the **Settings>System>More** menu.

TV Control Switch & Operation

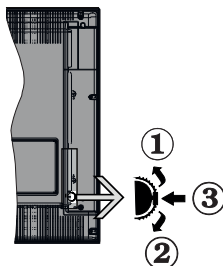

1. Up direction
2. Down direction
3. Volume / Info / Sources List selection and Standby-On switch

The Control button allows you to control the Volume / Programme / Source and Standby-On functions of the TV.

To change volume: Increase the volume by pushing the button up. Decrease the volume by pushing the button down.

To change channel: Press the middle of the button in, the information banner will appear on the screen. Scroll through the stored channels by pushing the button up or down.

To change source: Press the middle of the button in twice (for the second time in total), the source list will appear on the screen. Scroll through the available sources by pushing the button up or down.

To turn the TV off: Press the middle of the button in and hold it down for a few seconds, the TV will turn into standby mode.

To turn on the TV: Press the middle of the button in, the TV will turn on.

Notes:

If you turn the TV off, this cycle starts again beginning with the volume setting.

Main menu OSD cannot be displayed via control button.

Operation with the Remote Control

Press the **Home** button on your remote control to display main menu. Use the directional buttons and **OK** button to navigate and set. Press **Return/Back** or **Home** button to quit a menu screen.

Input Selection

Once you have connected external systems to your TV, you can switch to different input sources. Press the **Source** button on your remote control consecutively to select the different sources.

Changing Channels and Volume

You can change the channel and adjust the volume by using the **Programme +/-** and **Volume +/-** buttons on the remote.

Using Main TV Menu

When the **Home** button is pressed, the main TV menu will appear at the bottom of the screen. You can navigate through the menu items using the directional buttons on the remote. To select an item or see the sub-menu options of the highlighted menu press **OK** button. When you highlight a menu option some of the sub-menu items of this menu may appear on the upper side of the menu bar for quick access. To use a quick access item highlight it, press **OK** and set as desired using the Left/Right directional buttons. When finished press **OK** or **Back/Return** button to exit.

Press **Exit** button to close the main menu.

1. Home

When main menu is opened **Home** menu bar will be highlighted. The content of the **Home** menu can be customised by adding options from other menus. Just highlight an option and press the Down direction button on the remote. If you see **Add to Home** option you can add it to the **Home** menu. Same way you can delete or change the position of any item in the **Home** menu. Press the Down direction button and select **Delete** or **Move** option and press **OK**. In order to move a menu item use the Right and Left direction buttons to select the position that you want the item to move to and press **OK**.

2. TV

2.1. Guide

You can access the electronic programme guide menu using this option. Refer to **Electronic Programme Guide** section for more information.

2.2. Channels

You can access the **Channels** menu using this option. Refer to **Using the Channel List** section for more information.

2.3. Timers

You can set timers for future events using the options of this menu. You can also review the previously created timers under this menu.

To add a new timer select the **Add Timer** tab using the Left/Right buttons and press **OK**. Set the sub-menu options as desired and when finished press **OK**. A new timer will be created.

To edit a previously created timer, highlight that timer, select the **Edit Selected Timer** tab and press **OK**. Change the sub-menu options as desired and press **OK** to save your settings.

To cancel an already set timer, highlight that timer, select **Delete Selected Timer** tab and press **OK**. A

confirmation message will be displayed. Highlight **Yes** and press **OK** to proceed. The timer will be cancelled.

It is not possible to set timers for two or more events that will be broadcasted in different channels at the same time interval. In this case you will be asked to choose one of these timers and cancel others. Highlight the timer you want to cancel and press **OK**, **Options** menu will be displayed. Then highlight **Set/Cancel** and press **OK** to cancel that timer. You will have to save changes after that. In order to do that press **OK**, highlight **Save Changes** and press **OK** again.

3. Settings

You can manage the settings of your TV using the options of this menu. Refer to **Settings Menu Contents** section for more information.

4. Apps

When your TV is connected to the Internet related contents will also be available, including **Apps** related contents. Using the **Apps** menu you can access and manage your applications. You can add new apps from the market or delete the existing ones. Refer to **Apps** section for more information.

5. Sources

You can manage your input source references using the options of this menu. To change the current source highlight one of the options and press **OK**.

5.1. Source Settings

Edit the names, enable or disable selected source options.

Inserting the Batteries into the Remote

Remove the back cover to reveal the battery compartment. Insert two size **AA** batteries. Make sure the (+) and (-) signs match (observe correct polarity). Do not mix old and new batteries. Replace only with same or equivalent type. Place the cover back on.

A message will be displayed on the screen when the batteries are low and must be replaced. Note that when the batteries are low, the performance of the remote control may be impaired.

Batteries should not be exposed to excessive heat such as sunshine, fire or the like.



Power Connection

IMPORTANT: The TV set is designed to operate on a **220-240V AC, 50 Hz** supply. After unpacking, allow the TV set to reach the ambient room temperature before you connect the set to the mains. Plug the power cable to the mains socket outlet.

Antenna Connection

Connect the aerial or cable TV plug to the **AERIAL INPUT (ANT-TV)** socket located on the rear side of the TV.

Rear side of the TV

ANT-TV

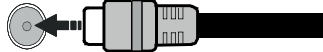

If you want to connect a device to the TV, make sure that both the TV and the device are turned off before making any connection. After the connection is done, you can turn on the units and use them.

License Notification

The terms HDMI and HDMI High-Definition Multimedia Interface, and the HDMI Logo are trademarks or registered trademarks of HDMI Licensing Administrator, Inc. in the United States and other countries.



Manufactured under license from Dolby Laboratories. Dolby, Dolby Audio and the double-D symbol are trademarks of Dolby Laboratories.



YouTube and the YouTube logo are trademarks of Google Inc.

This product contains technology subject to certain intellectual property rights of Microsoft. Use or distribution of this technology outside of this product is prohibited without the appropriate license(s) from Microsoft.

Content owners use Microsoft PlayReady™ content access technology to protect their intellectual property, including copyrighted content. This device uses PlayReady technology to access PlayReady-protected content and/or WMDRM-protected content. If the device fails to properly enforce restrictions on content usage, content owners may require Microsoft to revoke the device's ability to consume PlayReady-protected content. Revocation should not affect unprotected content or content protected by other content access technologies. Content owners may require you to upgrade PlayReady to access their content. If you decline an upgrade, you will not be able to access content that requires the upgrade.

The "CI Plus" Logo is a trademark of CI Plus LLP.

This product is protected by certain intellectual property rights of Microsoft Corporation. Use or distribution of such technology outside of this product is prohibited without a license from Microsoft or an authorized Microsoft subsidiary.

Disposal of Old Equipment and Batteries



Only for European Union and countries with recycling systems

These symbols on the products, packaging, and/or accompanying documents mean that used electrical and electronic products and batteries must not be mixed with general household waste.

For proper treatment, recovery and recycling of old products and batteries, please take them to applicable collection points in accordance with your national legislation.

By disposing of them correctly, you will help to save valuable resources and prevent any potential negative effects on human health and the environment.

For more information about collection and recycling, please contact your local municipality.

Penalties may be applicable for incorrect disposal of this waste, in accordance with national legislation.

Note for the battery symbol (bottom symbol):



This symbol might be used in combination with a chemical symbol. In this case it complies with the requirement set by the Directive for the chemical involved.

Declaration of Conformity (DoC)

Hereby, Panasonic Marketing Europe GmbH, declares that this TV is in compliance with the essential requirements and other relevant provisions of the Directive 2014/53/EU.

If you want to get a copy of the original DoC of this TV, please visit the following website:

<http://www.ptc.panasonic.eu/doc>

Authorized Representative:

Panasonic Testing Centre

Panasonic Marketing Europe GmbH

Winsbergring 15, 22525 Hamburg, Germany

Web Site: <http://www.panasonic.com>

Customer Communication Centre

- For customers within the UK: **0344 844 3899**
- For customers within Ireland: **01289 8333**
- Monday - Friday 9:00am - 5:00pm, (Excluding public holidays).
- For further support on your product, please visit our website: **www.panasonic.co.uk**

Direct Sales at Panasonic UK

- Order accessory and consumable items for your product with ease and confidence by phoning our Customer Communications Centre Monday - Friday 9:00am - 5:00pm, (Excluding public holidays).
- Or go on line through our Internet Accessory ordering application at **www.pas-europe.com**.
- Most major credit and debit cards accepted.
- All enquiries transactions and distribution facilities are provided directly by Panasonic UK.
- It couldn't be simpler!
- Also available through our Internet is direct shopping for a wide range of finished products. Take a browse on our website for further details.

TV Broadcasting	PAL BG//DK SECAM BG/DK
Receiving Channels	VHF (BAND I/III) - UHF (BAND U) - HYPERBAND
Digital Reception	Fully integrated digital terrestrial-cable TV (DVB-T-C) (DVB-T2 compliant)
Number of Preset Channels	1 000
Channel Indicator	On Screen Display
RF Aerial Input	75 Ohm (unbalanced)
Operating Voltage	220-240V AC, 50Hz.
Audio	A2 Stereo+Nicam Stereo
Headphone	3.5 mm mini stereo jack
Audio Output Power (WRMS.) (10% THD)	2 x 8 W
Power Consumption (W)	75 W
Networked Standby (W)	< 2
Weight (kg)	8.7 Kg
TV Dimensions DxLxH (with stand) (mm)	235 x 889 x 565
TV Dimensions DxLxH (without stand) (mm)	76/95 x 889 x 523
Display	16/9 39"
Operation temperature and operation humidity	0°C up to 40°C, 85% humidity max

Wireless LAN Transmitter Specifications

Frequency Ranges	Max Output Power
2400 - 2483,5 MHz (CH1-CH13)	< 100 mW
5150 - 5250 MHz (CH36 - CH48)	< 200 mW
5250 - 5350 MHz (CH52 - CH64)	< 200 mW
5470 - 5725 MHz (CH100 - CH140)	< 200 mW

Country Restrictions

This device is intended for home and office use in all EU countries (and other countries following the relevant EU directive) without any limitation except for the countries mentioned below.

Country	Restriction
Bulgaria	General authorization required for outdoor use and public service
France	In-door use only for 2454-2483.5 MHz
Italy	If used outside of own premises, general authorization is required
Greece	In-door use only for 5470 MHz to 5725 MHz band
Luxembourg	General authorization required for network and service supply(not for spectrum)
Norway	Radio transmission is prohibited for the geographical area within a radius of 20 km from the centre of Ny-Alesund
Russian Federation	In-door use only

The requirements for any country may change at any time. It's recommended that user checks with local authorities for the current status of their national regulations for both 2.4 GHz and 5 GHz wireless LAN's.

Standard

IEEE 802.11.a/b/g/n

Host Interface

USB 2.0

Security

WEP 64/128, WPA, WPA2, TKIP, AES, WAPI

Notice

DVB / Data broadcasting / IPTV functions

- This TV is designed to meet the standards (as of August, 2017) of DVB-T / T2 (MPEG2, MPEG4-AVC(H.264) and HEVC(H.265)) digital terrestrial services and DVB-C (MPEG2, MPEG4-AVC(H.264) and HEVC(H.265)) digital cable services.

Consult your local dealer for availability of DVB-T / T2 services in your area.

Consult your cable service provider for availability of DVB-C services with this TV.

- This TV may not work correctly with the signal which does not meet the standards of DVB-T / T2 or DVB-C.
- Not all the features are available depending on the country, area, broadcaster, service provider and network environment.
- Not all CI modules work properly with this TV. Consult your service provider about the available CI module.
- This TV may not work correctly with CI module that is not approved by the service provider.
- Additional fees may be charged depending on the service provider.
- The compatibility with future services is not guaranteed.

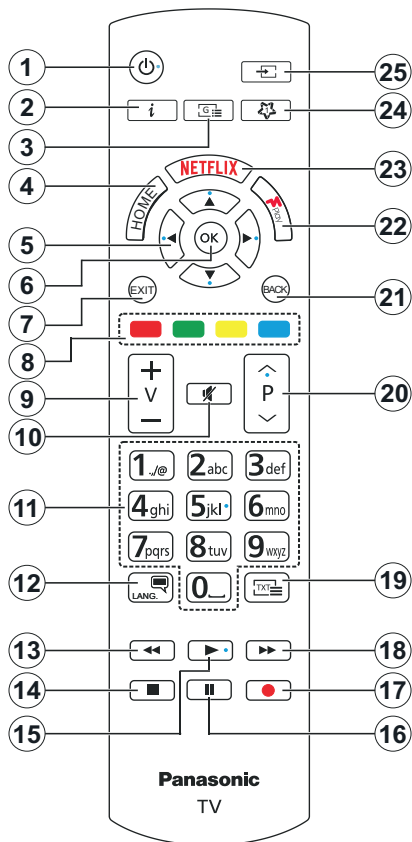



























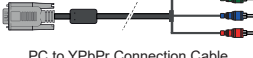
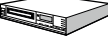

(*) MY BUTTON 1:

This button may have default function depending on the model. However you can set a special function to this button by pressing on it for five seconds when on a desired source or channel. A confirmation message will be displayed on the screen. Now the My Button 1 is associated with the selected function.

Note that if you perform **First Time Installation**, My Button 1 will return to its default function.

1. **Standby:** Switches On / Off the TV
2. **Info:** Displays information about on-screen content, shows hidden information (reveal - in TXT mode)
3. **Guide:** Displays the electronic programme guide
4. **Home:** Displays TV menu
5. **Directional buttons:** Helps navigate menus, content etc. and displays the subpages in TXT mode when pressed Right or Left
6. **OK:** Confirms user selections, holds the page (in TXT mode), views **Channels** menu (DTV mode)
7. **Exit:** Closes and exits from displayed menus or returns to previous screen
8. **Coloured Buttons:** Follow the on-screen instructions for coloured button functions
9. **Volume +/-**
10. **Mute:** Completely turns off the volume of the TV
11. **Numeric buttons:** Switches the channel, enters a number or a letter in the text box on the screen, switches the TV on when in standby mode
12. **Language:** Switches among sound modes (analogue TV), displays and changes audio/subtitle language and turns subtitles on or off (digital TV, where available)
13. **Rewind:** Moves frames backwards in media such as movies
14. **Stop:** Stops the media being played
15. **Play:** Starts to play selected media
16. **Pause:** Pauses the media being played
17. No function
18. **Fast Forward:** Moves frames forward in media such as movies
19. **Text:** Displays teletext (where available), press again to superimpose the teletext over a normal broadcast picture (mix)
20. **Programme +/-:** Programme up-down, Page up-down (in TXT mode), switches the TV on when in standby mode
21. **Back/Return:** Returns to previous screen, previous menu, opens index page (in TXT mode). Quickly cycles between previous and current channels or sources
22. **Freeview Play:** Connects to the Freeview Play platform where you can access available catch-up TV services
23. **Netflix:** Launches the Netflix application
24. **My Button 1 (*)**
25. **Source:** Shows available broadcast and content sources

Connections

Connector	Type	Cables	Device
	VGA Connection (back)		
AUDIO IN 	PC/YPbPr Audio Connection (back)	 YPbPr/PC Audio Cable	
	HDMI Connection (side&back)		
SPDIF 	SPDIF (Optical Out) Connection (back)		
BACK AV 	Back AV (Audio/Video) Connection (back)	 Audio Video Cable	
HEADPHONE 	Headphone Connection (side)		
YPBPR 	YPbPr Video Connection (back)	 PC to YPbPr Connection Cable	
	USB Connection (side)		
	CI Connection (side)		
LAN 	Ethernet Connection (back)	 LAN / Ethernet Cable	

See the illustrations on the left side. You can use YPbPr to VGA cable to enable YPbPr signal via VGA input. You cannot use VGA and YPbPr at the same time. To enable PC/YPbPr audio, you will need to use the back audio inputs with a YPbPr/PC audio cable for audio connection. When using the wall mounting kit (available from a third party in the market, if not supplied), we recommend that you plug all your cables into the back of the TV before mounting on the wall. Insert or remove the CI module only when the TV is SWITCHED OFF. You should refer to the module instruction manual for details of the settings. The/ Each USB input of your TV supports devices up to 500mA. Connecting devices that have current value above 500mA may damage your TV. When connecting equipment using a HDMI cable to your TV, to guarantee sufficient immunity against parasitic frequency radiation, you have to use a high speed shielded (high grade) HDMI cable with ferrites.



If you want to connect a device to the TV, make sure that both the TV and the device are turned off before making any connection. After the connection is done, you can turn on the units and use them.

Switching On/Off

To Switch the TV On

Connect the power cord to a power source such as a wall socket (220-240V AC, 50 Hz).

To switch on the TV from standby mode either:

- Press the **Standby** button, **Programme +/-** or a numeric button on the remote control.
- Press the middle of the side function switch on the TV in.

To Switch the TV Off

Press the **Standby** button on the remote control or press the middle of the side function switch on the TV in and hold it down for a few seconds, the TV will switch into standby mode.

To power down the TV completely, unplug the power cord from the mains socket.

Note: When the TV is switched into standby mode, the standby LED can blink to indicate that features such as Standby Search, Over Air Download or Timer is active. The LED can also blink when you switch on the TV from standby mode.

First Time Installation

When turned on for the first time, the language selection screen is displayed. Select the desired language and press **OK**. In the following steps of the installation guide, set your preferences using the directional buttons and **OK** button.

On the second screen set your country preference. Depending on the **Country** selection you may be asked to set and confirm a PIN at this point. The selected PIN cannot be 0000. You have to enter it if you are asked to enter a PIN for any menu operation later.

You can activate **Store Mode** option in the next step. This option will configure your TV's settings for store environment and depending on the TV model being used, the supported features of it may be displayed on the side of the screen as an info banner. This option is intended only for store use. It is recommended to select **Home Mode** for home use. This option will be available in **Settings>System>More** menu and can be turned off/on later. Make your selection and press **OK** to continue.

Depending on the model of your TV and the country selection **Privacy Settings** menu may appear at this point. Using this menu you can set your privacy privileges. Highlight a feature and use Left and Right directional buttons to enable or disable. Read the related explanations displayed on the screen for each highlighted feature before making any changes. You can use **Programme +/-** buttons to scroll up and down to read the entire text. You will be able to change your preferences at any time later from the **Settings>System>Privacy Settings** menu. If the **Internet Connection** option is disabled **Network/Internet Settings** screen will be skipped

and not displayed. If you have any questions, complaints or comments regarding this privacy policy or its enforcement, please contact by email at smartvsecurity@vosshub.com.

Highlight **Next** and press **OK** button on the remote control to continue and the **Network/Internet Settings** menu will be displayed. Please refer to **Connectivity** section to configure a wired or a wireless connection. If you want your TV to consume less power in standby mode, you can disable the **Wake On** option by setting it as **Off**. After the settings are completed highlight **Next** and press **OK** button to continue.

On the next screen you need to agree to the terms and conditions of Freeview Play to make use of the related services. Scroll the page to read the entire text using the up/down directional buttons or **Programme +/-** buttons. Highlight **Yes** and press **OK** on the remote to confirm and proceed. Highlight **No** and press **OK** to proceed without confirmation. For further requirements for Freeview Play services refer to the **Freeview Play Platform** section.

On next screen you can set broadcast types to be searched, set your encrypted channel searching and time zone (depending on the country selection) preferences. Additionally you can set a broadcast type as your favourite one. Priority will be given to the selected broadcast type during the search process and the channels of it will be listed on the top of the channel list. When finished, highlight **Next** and press **OK** to continue.

About Selecting Broadcast Type

To turn a search option for a broadcast type highlight it and press **OK**. The checkbox next to the selected option will be checked. To turn the search option off clear the checkbox by pressing **OK** after moving the focus on the desired broadcast type option.

Digital Aerial: If **D. Aerial** broadcast search option is turned on, the TV will search for digital terrestrial broadcasts after other initial settings are completed.

Digital Cable: If **D. Cable** broadcast search option is turned on, the TV will search for digital cable broadcasts after other initial settings are completed. A message will be displayed before starting to search asking if you want to perform cable network search. If you select **Yes** and press **OK** you can select **Network** or set values such as **Frequency**, **Network ID** and **Search Step** on the next screen. If you select **No** and press **OK** you can set **Start Frequency**, **Stop Frequency** and **Search Step** on the next screen. When finished, highlight **Next** and press **OK** button to continue.

Note: Searching duration will change depending on the selected Search Step.

Analogue: If **Analogue** broadcast search option is turned on, the TV will search for analogue broadcasts after other initial settings are completed.

After the initial settings are completed TV will start to search for available broadcasts of the selected broadcast types.

While the search continues current scan results will be displayed at the bottom of the screen. After all the available stations are stored, **Channels** menu will be displayed. You can edit the channel list according to your preferences using the **Edit** tab options or press the **Home** button to quit and watch TV.

While the search continues a message may appear, asking whether you want to sort channels according to the LCN(*). Select **Yes** and press **OK** to confirm.

(* LCN is the Logical Channel Number system that organizes available broadcasts in accordance with a recognizable channel number sequence (if available).

Note: Do not turn off the TV while initializing first time installation. Note that, some options may not be available depending on the country selection.

Media Playback via USB Input

You can connect 2.5" and 3.5" inch (HDD with external power supply) external hard disk drives or USB memory stick to your TV by using the USB inputs of the TV.

IMPORTANT! Back up the files on your storage devices before connecting them to the TV. Manufacturer will not be responsible for any file damage or data loss. Certain types of USB devices (e.g. MP3 Players) or USB hard disk drives/memory sticks may not be compatible with this TV. The TV supports FAT32 and NTFS disk formatting.

Wait a little while before each plugging and unplugging as the player may still be reading files. Failure to do so may cause physical damage to the USB player and the USB device itself. Do not pull out your drive while playing a file.

You can use USB hubs with your TV's USB inputs. External power supplied USB hubs are recommended in such a case.

It is recommended to use the TV's USB input(s) directly, if you are going to connect a USB hard disk.

Note: When viewing image files the **Media Browser** menu can only display 1000 image files stored on the connected USB device.





Media Browser

You can play back music and movie files and display photo files stored on a USB storage device by connecting it to your TV. Connect a USB storage device to one of the USB inputs located on the side of the TV.

After connecting a USB storage device to your TV **Media Browser** menu will be displayed on the screen. You can access the content of the connected USB device any time later from the **Sources** menu. Select the related USB input option from this menu and press **OK**. Then select the file of your choice and press **OK** to display or play it back.

You can set your **Media Browser** preferences by using the **Settings** menu. **Settings** menu can be accessed via the information bar which is displayed on the bottom of the screen when pressed the **Info** button while playing back a video file or displaying a picture file. Press the **Info** button, highlight the gear wheel symbol positioned on the right side of the information bar and press **OK**. **Picture Settings**, **Sound Settings**, **Media Browser Settings** and **Options** menus will be available. The contents of these menus may change according to the type of the currently open media file. Only **Sound Settings** menu will be available while playing back audio files.

Loop/Shuffle Mode Operation

Start playback and activate 	All files in the list will be continuously played in original order
Start playback and activate 	The same file will be played continuously (repeat)
Start playback and activate 	All files in the list will be played once in random order
Start playback and activate 	All files in the list will be continuously played in the same random order

To use the functions on the information bar highlight the symbol of the function and press **OK**. To change the status of a function highlight the symbol of the function and press **OK** as much as needed. If the symbol is marked with a red cross, that means it is deactivated.

This function allows to control the CEC-enabled devices, that are connected through HDMI ports by using the remote control of the TV.

The **CEC** option in the **Settings>System>More** menu should be set as **Enabled** at first. Press the **Source** button and select the HDMI input of the connected CEC device from the **Sources List** menu. When new CEC source device is connected, it will be listed in source menu with its own name instead of the connected HDMI ports name(such as DVD Player, Recorder 1 etc.).

The TV remote is automatically able to perform the main functions after the connected HDMI source has been selected. To terminate this operation and control the TV via the remote again, press and hold the "0-Zero" button on the remote control for 3 seconds.

You can disable the CEC functionality by setting the related option under the **Settings>System>More** menu accordingly.

The TV supports ARC (Audio Return Channel). This feature is an audio link meant to replace other cables between the TV and an audio system (A/V receiver or speaker system).

When ARC is active, the TV does not mute its other audio outputs automatically. You will need to decrease TV volume to zero manually if you wish to hear the ARC audio only (same as optical or co-axial digital audio outputs). If you want to change connected device's volume level, you should select that device from the source list. In that case volume control keys are directed to connected audio device.

Note: ARC is supported only via the HDMI2 input.

System Audio Control

Allows an Audio Amplifier/Receiver to be used with the TV. The volume can be controlled using the remote control of the TV. To activate this feature set the **Speakers** option in the **Settings>System>More** menu as **Amplifier**. The TV speakers will be muted and the sound of the watched source will be provided from the connected sound system.

*Note: The audio device should support System Audio Control feature and CEC option should be set as **Enabled**.*

Settings Menu Contents

Picture Menu Contents	
Mode	You can change the picture mode to suit your preference or requirements. Picture mode can be set to one of these options: Cinema , Game (optional), Sports , Dynamic and Natural .
Contrast	Adjusts the light and dark values on the screen.
Brightness	Adjusts the brightness values on the screen.
Sharpness	Sets the sharpness value for the objects displayed on the screen.
Colour	Sets the colour value, adjusting the colours.
Energy Saving	For setting the Energy Saving to Custom , Minimum , Medium , Maximum , Auto , Screen Off or Off . <i>Note: Available options may differ depending on the selected Mode.</i>
Backlight	This setting controls the backlight level. The backlight function will be inactive if the Energy Saving is set to an option other than Custom .
Advanced Settings	
Dynamic Contrast	You can change the dynamic contrast ratio to desired value.
Noise Reduction	If the signal is weak and the picture is noisy, use the Noise Reduction setting to reduce the amount of noise.
Colour Temp	Sets the desired colour temperature value. Cool , Normal , Warm and Custom options are available.
White Point	If the Colour Temp option is set as Custom , this setting will be available. Increase the 'warmth' or 'coolness' of the picture by pressing Left or Right buttons.
Picture Zoom	Sets the desired image size format.
Picture Shift	This option may be available depending on the Picture Zoom setting. Highlight and press OK , then use directional buttons to shift the picture upwards or downwards.
Film Mode	Films are recorded at a different number of frames per second to normal television programmes. Turn this feature on when you are watching films to see the fast motion scenes clearly.
Skin Tone	Skin tone can be changed between -5 and 5.
Colour Shift	Adjust the desired colour tone.
HDMI Full Range	While watching from a HDMI source, this feature will be visible. You can use this feature to enhance blackness in the picture.
PC Position	Appears only when the input source is set to VGA/PC.
Autoposition	If the image is not centered in VGA mode use this option to automatically adjust the position of the image. Press OK to start the auto adjustment.
H Position	This item shifts the image horizontally to the right hand side or left hand side of the screen.
V Position	This item shifts the image vertically towards the top or bottom of the screen.
Dot Clock	Dot Clock adjustments correct the interference that appear as vertical banding in dot intensive presentations like spreadsheets or paragraphs or text in smaller fonts.
Phase	Depending on the input source(computer etc.) you may see a hazy or noisy picture on the screen. You can use phase to get a clearer picture by trial and error.
Reset	Resets the picture settings to factory default settings (except Game mode).
<i>While in VGA (PC) mode, some items in Picture menu will be unavailable. Instead, VGA mode settings will be added to the Picture menu while in PC mode.</i>	

Sound Menu Contents	
Volume	Adjusts the volume level.
Equalizer	Selects the equalizer mode. Custom settings can be made only when in User mode.
Balance	Adjusts whether the sound comes from the left or right speaker.
Headphone	Sets headphone volume. Please ensure before using headphones that the headphone volume is set to a low level, to prevent damage to your hearing.
Sound Mode	You can select a sound mode (If the viewed channel supports).
AVL (Automatic Volume Limiting)	Sets the sound to obtain fixed output level between programmes. If the Dolby Audio menu item is set to an option other than Off the AVL setting options will change. Auto , Night , Normal and Off options will be available. In Auto mode the TV will switch to Normal or Night mode automatically according to the current time information. If no time information is available this option will always function as Normal . When the TV switches to Night mode for the first time after setting this option as Auto , an information bar will pop up on the screen. Please note that compared to Normal mode Night mode provides more aggressive dynamic compression control which is suitable for silent environments.
Headphone/Lineout	When you connect an external amplifier to your TV using the headphone jack, you can select this option as Lineout . If you have connected headphones to the TV, set this option as Headphone . Please ensure before using headphones that this menu item is set to Headphone . If it is set to Lineout , the output from the headphone socket will be set to maximum which could damage your hearing.
Dynamic Bass	Enables or disables the Dynamic Bass.
Dolby Audio	Smart , Movie , Music , News and Off options will be available. Set as Off to disable. <i>Note: Some items in Sound menu will be grayed out and unavailable if set to an option other than Off.</i>
Surround sound	Surround sound mode can be changed as On or Off .
Sound Output	Sets the sound output preference. TV , S/PDIF and HDMI ARC options will be available. There will be no sound output except through the selected option. If HDMI ARC option is selected, CEC feature will be enabled. <i>Note: Depending on the selected option some items in Sound menu will appear as grayed out and will be unavailable.</i>
Digital Out	Sets digital out audio type.

Network Menu Contents	
Network Type	Disable the network connection or change the connection type.
Scan Wireless Networks	Start a search for wireless networks. This option will be available if the Network Type is set as Wireless Device .
Press WPS on your wifi router	If your modem/router device has WPS, you can directly connect to it using this option. Highlight this option and press OK . Go to your modem/router device and press the WPS button on it to make the connection. This option will be available if the Network Type is set as Wireless Device .
Internet Speed Test	Start a speed test to check your connection bandwidth. The result will be displayed on the screen when finished.
Advanced Settings	Change the IP and DNS configurations of your TV.
Wake On	Enable or disable this feature by setting it as On or Off .
<i>Note: For detailed information on the options of this menu refer to the Connectivity section.</i>	

Installation Menu Contents	
Automatic channel scan (Retune)	Displays automatic tuning options. D. Aerial : Searches and stores aerial DVB stations. D. Cable : Searches and stores cable DVB stations. Analogue : Searches and stores analogue stations.
Manual channel scan	This feature can be used for direct broadcast entry.
Network channel scan	Searches for the linked channels in the broadcast system. D. Aerial : Searches for aerial network channels. D. Cable : Searches for cable network channels.
Analogue fine tune	You can use this setting for fine tuning analogue channels. This feature is not available if no analogue channels are stored and if currently watched channel is not an analogue channel.
Installation Settings (optional)	Displays installation settings menu. Standby Search (*) : Your TV will search for new or missing channels while in standby. Any new found broadcasts will be shown. Dynamic Channel Update(*) : If this option is set as Enabled, the changes on the broadcasts such as frequency, channel name, subtitle language etc., will be applied automatically while watching. <i>(*) Availability depends on model.</i>
Clear Service List	Use this setting to clear channels stored. This setting is visible only when the Country option is set to Denmark, Sweden, Norway or Finland.
Select Active Network	This setting allows you to select only the broadcasts within the selected network to be listed in the channel list. This feature is available only for the country option of Norway.
Signal Information	You can use this menu item to monitor signal related information such as signal level/quality, network name etc for available frequencies.
First time installation	Deletes all stored channels and settings, resets TV to factory settings.

System Menu Contents	
Conditional Access	Controls conditional access modules when available.
Language	You may set a different language depending on the broadcaster and the country.
Privacy Settings (*)	Manage your privacy privileges for smart TV related applications. Press OK to enter the menu and set according to your preferences.
Parental	Enter correct password to change parental settings. You can easily adjust Menu Lock , Maturity Lock , Child Lock or Guidance in this menu. You can also set a new PIN or change the Default CICAM PIN using the related options. <i>Note: Some menu options may not be available depending on the country selection in the First Time Installation. Default PIN could have been set to 0000 or 1234. If you have defined the PIN(is requested depending on the country selection) during the First Time Installation use the PIN that you have defined.</i>
Date/Time	Sets date and time.
Sources	Edit the names, enable or disable selected source options.
Accessibility	Displays accessibility options of the TV.
Hard of Hearing	Enables any special feature sent from the broadcaster.
Audio Description	A narration track will be played for the blind or visually impaired audience. Press OK to see all available Audio Description menu options. This feature is available only if the broadcaster supports it.
Netflix	If this feature is supported by your TV, you can view your ESN(*) number and deactivate Netflix. <i>(*) ESN number is a unique ID number for Netflix, created especially to identify your TV. Note: For 4K video streaming, a minimum 25Mb/s internet connection speed is required – For an example of the requirements for streaming 4K content you may find more information on the Netflix website (https://help.netflix.com/en/node/13444). When you start to stream video content via the internet the quality of your connection will be analysed and the full HD or 4K quality may take a short time to be realised, or in the event of a slow connection not be possible. You should check your internet capabilities with your internet provider if you are at all unsure.</i>
More	Displays other setting options of the TV.
Menu Timeout	Changes timeout duration for menu screens.
Standby LED	If set as Off the standby LED will not light up when the TV is in standby mode.
HBBTV (*)	You can enable or disable this feature by setting it as On or Off .
Software Upgrade	Ensures that your TV has the latest firmware. Press OK to see the menu options.
Application Version	Displays current software version.
Subtitle Mode	This option is used to select which subtitle mode will be on the screen (DVB subtitle / Teletext subtitle) if both is available. Default value is DVB subtitle. This feature is available only for the country option of Norway.
Auto TV OFF	Sets the desired time for the TV to automatically go into standby mode when not being operated. This option can be set from 1 to 8 hours in steps of 1 hour. You can also disable this option by setting as Off .
Store Mode	Select this mode for store display purposes. Whilst Store Mode is enabled, some items in the TV menu may not be available.
AVS (Audio Video Sharing)	AVS feature allows you to share files stored on your smartphone or tablet pc. If you have a compatible smartphone or tablet pc and the appropriate software is installed, you can share/play photos on your TV. See instructions of your sharing software for more information.
Power Up Mode	This setting configures the power up mode preference. Last State and Standby options are available.
Virtual Remote	Enable or disable the virtual remote feature.

CEC	With this setting you can enable and disable CEC functionality completely. Press Left or Right button to enable or disable the feature.
CEC Auto Power On	This function allows the connected HDMI-CEC compatible device to turn on the TV and switch to its input source automatically. Press Left or Right button to enable or disable the feature.
Speakers	To hear the TV audio from the connected compatible audio device set as Amplifier . You can use the remote control of the TV to control the volume of the audio device.
Show All Cookies (*)	Displays all saved cookies.
Delete All Cookies (*)	Deletes all saved cookies.
OSS	Displays Open Source Software license information.

() These features may not be available depending on the model of your TV and the selected country in the First Time Installation.*

General TV Operation

Using the Channel List

The TV sorts all stored stations in the channel list. You can edit this channel list, set favourites or set active stations to be listed by using the **Channels** menu options. Press the **OK** button to open the channel list. You can filter the listed channels or make advanced changes in the current list using the **Filter** and **Edit** tab options. Highlight the tab you want and press **OK** to see available options.

Managing the Favourite Lists

You can create four different lists of your favourite channels. Enter the **TV>Channels** menu or press the **OK** button in order to open the **Channels** menu. Highlight the **Edit** tab and press **OK** to see the editing options and select the **Tag/Untag channel** option. Select the desired channel on the list by pressing the **OK** button while the channel is highlighted. You can make multiple choices. You can also use the **Tag/Untag** all option to select all channels on the list. Then press **Back/Return** button to return to the Edit menu options. Select **Add/Remove Favourites** option and press the **OK** button again. Favourite channel list options will be displayed. Set the desired list option to **On**. The selected channel/s will be added to the list. In order to remove a channel or channels from a favourite list follow the same steps and set the desired list option to **Off**.

You can use the filtering function in the **Channels** menu to filter the channels in the channel list permanently according to your preferences. For instance, using the options of the **Filter** tab, you can set one of your four favourite lists to be displayed every time the channel list is opened.

Configuring Parental Settings

The **Parental** menu options can be used to prohibit users from viewing of certain programmes, channels and using of menus. These settings are located in the **Settings> System>Parental** menu.

To display parental lock menu options, a PIN should be entered. After coding the correct PIN, **Parental** menu will be displayed.

Menu Lock: This setting enables or disables access to all menus or installation menus of the TV.

Guidance: This setting enables or disables access some of the MHEG applications. Disabled applications can be released by entering the right PIN.

Internet Lock (*): If this option is set to **ON**, the internet using applications will be disabled. Set to **OFF** to release these applications again.

(* This feature may not be available depending on the model of your TV and the selected country in the First Time Installation.

Set PIN: Defines a new PIN number.

Default CICAM PIN: This option will appear as greyed out if no CI module is inserted into the CI slot of the TV. You can change the default PIN of the CI CAM using this option.

Note: Default PIN could have been set to **0000** or **1234**. If you have defined the PIN(is requested depending on the country selection) during the **First Time Installation** use the PIN that you have defined.

Some options may not be available depending on the model and/or on the country selection in the **First Time Installation**.

Electronic Programme Guide

By means of electronic programme guide function of your TV you can browse the event schedule of the currently installed channels on your channel list. It depends on the related broadcast whether this feature is supported or not.

To access the programme guide, press the **Guide** button on your remote. You can also use the **Guide** option under **TV** menu.

There are 2 different types of schedule layouts available, **Timeline Schedule** and **Now/Next**. To switch between these layouts highlight the tab with the name of the alternative layout on the upper side of the screen and press **OK**.

Use the directional buttons to navigate through the programme guide. Use the **Back/Return** button to use the tab options on the upper side of the screen.

Timeline Schedule

In this layout option, all events of the listed channels will be displayed by timeline. You can use the directional buttons to scroll through the list of the events. Highlight an event and press **OK** to display event options menu.

Press **Back/Return** button to use available tab options. Highlight **Filter** tab and press **OK** to see the filtering options. To change the layout highlight **Now/Next** and press **OK**. You can use the **Previous Day** and **Next Day** options to display the events of the previous and next day.

Highlight **Extras** tab and press **OK** to access below options.

Highlight Genre: Displays **Highlight Genre** menu. Select a genre and press **OK**. The events in the programme guide matching the selected genre will be highlighted.

Guide Search: Displays searching options. Using these options, you can search the programme guide database in accordance with the selected criteria. Matching results will be listed.

Now: Displays current event of the highlighted channel.

Zoom: Highlight and press **OK** to see events in a wider time interval.

Now/Next Schedule

In this layout option, only the current and next events of the listed channels will be displayed. You can use

the directional buttons to scroll through the list of the events.

Press **Back/Return** button to use available tab options. Highlight **Filter** tab and press **OK** to see the filtering options. To change the layout highlight **Timeline Schedule** and press **OK**.

Event Options

Use the directional buttons to highlight an event and press **OK** button to display **Options** menu. The following options are available.

Select Channel: Using this option, you can switch to the selected channel in order to watch it. The programme guide will be closed.

More Info: Display detailed information on the selected event. Use up and down directional buttons to scroll through the text.

Set Timer on Event / Delete Timer on Event: Select **Set Timer on Event** option and press **OK**. You can set timers for future events. To cancel an already set timer, highlight that event and press the **OK** button. Then select **Delete Timer on Event** option. The timer will be cancelled.

Notes: You cannot switch to any other channel while there is an active timer on the current channel.

It is not possible to set timer for two or more individual events at the same time interval.

Integrated Catch-Up Services

You can enjoy Freeview Play catch-up TV services that work directly through the electronic programme guide. Whilst you are on a channel use the directional buttons to scroll back in time through the timeline-based guide. You will see contents from last few days. Available catch-up contents may change according to broadcasters and will be marked with a play icon. Highlight the content you want to play back and press the **OK** button.

Make sure that your TV is connected to your home network in order to use the catch-up services. For further information regarding this matter and other requirements for Freeview Play services refer to the **Connectivity** and **Freeview Play Platform** sections.

Teletext Services (where available)

Press the **Text** button to enter. Press again to activate mix mode, which allows you to see the teletext page and the TV broadcast at the same time. Press once more to exit. If available, sections in the teletext pages will become colour-coded and can be selected by pressing the coloured buttons. Follow the instructions displayed on the screen.

Digital Teletext

Press the **Text** button to view digital teletext information. Operate it with the coloured buttons, cursor buttons and the **OK** button. The operation method may differ depending on the contents of the digital teletext. Follow the instructions displayed on the digital teletext screen.

When the **Text** button is pressed again, the TV returns to television broadcast.

MHEG Teletext

With digital terrestrial broadcasting (DVB-T), in addition to pictures and sound, you can also view digital teletext. Digital teletext is sometimes broadcast at the same time with the normal broadcasting.

- Press the **Text** or **Red** button
- The digital teletext information appears
- Operate it with the coloured buttons, directional buttons and **OK** button

The operation method may differ depending on the contents of the digital teletext. Follow the instructions displayed on digital teletext screen. Press the **Text** button to return to television broadcast.

BBC Red Button+ (RB+)

While watching BBC channels, press the **Red** button or **Text** button to access **Red Button+** services provided by the BBC. On the opening page you can access to BBC's main services such as BBC iPlayer, BBC News, BBC Sport and many others. There are also links to the home pages of the related applications available. Use the navigation buttons on the TV's remote control to move through the application. Press **Exit** button to close and exit.

Software Upgrade

Your TV is capable of finding and updating the firmware automatically via the broadcast signal or via Internet.

Software upgrade search via user interface

On the main menu select **Settings>System** and then **More**. Navigate to **Software upgrade** and press the **OK** button. Then select **Scan for upgrade** and press **OK** button to check for a new software upgrade.

If a new upgrade is found, it starts to download the upgrade. After the download is completed, a warning will be displayed, press **OK** button to complete software upgrade process and restart TV.

3 AM search and upgrade mode

Your TV will search for new upgrades at 3:00 o'clock if **Automatic scanning** option is set to **Enabled** and if the TV is connected to an aerial signal or to Internet. If a new software is found and downloaded successfully, it will be installed at the next power on.

Note: Do not unplug the power cord while led is blinking during the reboot process. If the TV fails to come on after the upgrade, unplug, wait for two minutes then plug it back in.

All updates are automatically controlled. If a manual search is carried out and no software is found then this is the current version.

Troubleshooting & Tips

TV will not turn on

Make sure the power cord is plugged in securely to a wall outlet. Press the Power button on the TV.

Poor picture

- Check if you have correctly tuned the TV.
- Low signal level can cause picture distortion. Please check antenna connections.
- Check if you have entered the correct channel frequency if you have performed manual tuning.

No picture

- TV is not receiving any signal. Make sure the correct source has been selected.
- Is the antenna connected properly?
- Is the antenna cable damaged?
- Are suitable plugs used to connect the antenna?
- If you are in doubt, consult your dealer.

No sound

- Check if the TV sound is muted. Press the **Mute** button or increase the volume to check.
- Sound may be coming from only one speaker. Check the balance settings from Sound menu.

Remote control - no operation

- The batteries may be exhausted. Replace the batteries.
- The batteries maybe inserted incorrectly. Refer to the section "Inserting the Batteries into the Remote".

No signal on an input source

- It is possible that no device is connected.
- Check the AV cables and connections from your device.
- Check the device is switched on.

The Image is not centered in VGA source

To have your TV automatically center the image, enter the **PC Position** menu in **Picture** menu, highlight **Autoposition** and press **OK**. Wait for it to finish. In order to set the position of the image manually you can use **H Position** and **V Position** options. Select the desired option and use Left and Right directional buttons on the remote to set.

PC Input Typical Display Modes

The following table is an illustration of some of the typical video display modes. Your TV may not support all resolutions.

Index	Resolution	Frequency
1	640x480	60Hz
2	640x480	75Hz
3	800x600	56Hz
4	800x600	60Hz
5	800x600	72Hz
6	800x600	75Hz

Index	Resolution	Frequency
7	1024x768	60Hz
8	1024x768	70Hz
9	1024x768	75Hz
10	1152x864	75Hz
11	1280x768	60Hz
12	1360x768	60Hz
13	1280x960	60Hz
14	1280x1024	60Hz
15	1280x1024	75Hz
16	1400x1050	60Hz
17	1440x900	60Hz
18	1440x900	75Hz
19	1920x1080	60Hz

AV and HDMI Signal Compatibility

Source	Supported Signals	Available	
Back AV	PAL	O	
	SECAM	O	
	NTSC4.43	O	
	NTSC3.58	O	
YPbPr	480i, 480p	60Hz	O
	576i, 576p	50Hz	O
	720p	50Hz,60Hz	O
	1080i	50Hz,60Hz	O
HDMI	480i, 480p	60Hz	O
	576i, 576p	50Hz	O
	720p	50Hz,60Hz	O
	1080i	50Hz,60Hz	O
	1080p	24Hz, 25Hz, 30Hz, 50Hz, 60Hz	O

(X: Not Available, O: Available)

In some cases a signal on the TV may not be displayed properly. The problem may be an inconsistency with standards from the source equipment (DVD, Set-top box, etc.). If you do experience such a problem please contact your dealer and also the manufacturer of the source equipment.

Supported File Formats for USB Mode

Video File Formats

Extension	Video Codec	Max. Resolution & Frame Rate & Bit Rate
.mpg, .mpeg, .dat, .vob	MPEG1/2, H.264, VC1	H.264: 1080Px2@30fps - 50Mbps, 1080P@60fps - 50Mbps Other: 1080P@60fps - 50Mbps
.ts, .trp, .m2ts		
.avi	MPEG1/2, MPEG4, H.264, MJPEG	
.mp4, .m4a, .m4v, .mov, .qt, .3gp, .3g2, .3gpp	MPEG1/2, H.263, MPEG4, H.264	
.mkv	MPEG 1/2, MPEG4, H.264	
.flv	Sorenson Sp, MPEG4, H.264	
.ogm, .ogg	MPEG1/2, MPEG4	
.asf, .wmv	MPEG4, WMV3, VC1	
.rm, .rmvb	RV30, RV40	
.webm	VP9, VP8	
.mp4, .mov, .3gpp, .3gp, MPEG transport stream, .ts, .trp, .tp, .mkv	HEVC/H.265	

Picture File Formats

Extension	Specification	Resolution (width x height)
.jpg, .jpeg	Baseline	8192 x 8192
	Progressive	3000 x 3000
.bmp	RGB 1/4/8/16/24/32 bit	8192 x 8192
	RLE 4/8 bit	
.gif	87a	
	89a (Only 1 picture at animation format)	
.png	Grayscale, 24/32 bit per pixel	
	Interlace format	
	Progressive	
.tiff, .tif	Tagged image file format	
.webp	Lossy compression VP8 key frame version number support 0~3	
	Lossless compression	

Audio File Formats

Extension	Format
.mp3	.mp3
.ac3	.ac3
.aac	.AAC
.wma	.WMA
.amr	.AMR-NB, .AMR-WB
.wav	.MPEG La, .AAC, .PCM
.flac	.FLAC

External Subtitles	
Extension	Specification
.ssa	SubStation Alpha
.ass	Advanced SubStation Alpha
.srt	Subripper
.sub	Micro DVD / SubViewer
.sub + .idx	VOBSub
.txt	Micro DVD / TMPlayer / MPL2
.mpl	MPL2
.smi	Sami
.jss	JACOSUB
.ttml	TTML
.txt / .sub	DVDSUBTITLE
.lrc	-

Internal Subtitles	
Extension	Specification
.mkv	VOBSub
.mkv	ASS / SSA / TEXT
.dat, .mpg, .mpeg, .vob	DVD Subtitle
.mp4	DVD Subtitle, TEXT

Supported DVI Resolutions

When connecting devices to your TV's connectors by using DVI converter cable(DVI to HDMI cable - not supplied), you can refer to the following resolution information.

	56Hz	60Hz	66Hz	70Hz	72Hz	75Hz
640x400				x		
640x480		x	x		x	x
800x600	x	x		x	x	x
832x624						x
1024x768		x	x	x	x	x
1152x864		x		x		x
1152x870						x
1280x768		x				x
1360x768		x				
1280x960		x				x
1280x1024		x				x
1400x1050		x				x
1440x900		x				x
1600x1200		x				
1680x1050		x				
1920x1080		x				

Connectivity

Wired Connectivity

To Connect to a Wired Network

- You must have a modem/router connected to an active broadband connection.
- Connect your TV to your modem/router via an Ethernet cable. There is a LAN port at the rear (back) of your TV.

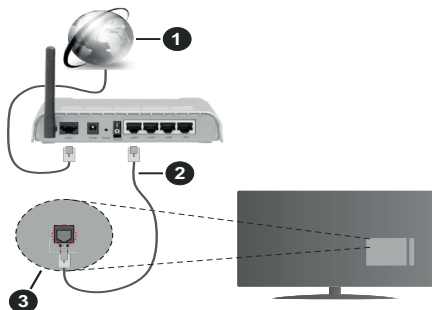

1. Broadband ISP connection
2. LAN (Ethernet) cable
3. LAN input on the rear side of the TV

To configure wired settings refer to the Network section in the Settings menu.

- You might be able to connect your TV to your LAN depending on your network's configuration. In such a case, use an Ethernet cable to connect your TV directly to the network wall outlet.

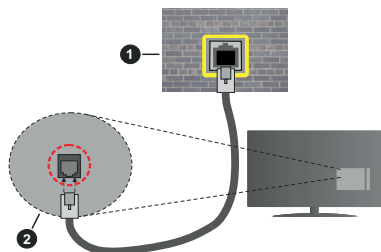

1. Network wall socket
2. LAN input on the rear side of the TV

Configuring Wired Device Settings

Network Type

The **Network Type** can be selected as **Wired Device**, **Wireless Device** or **Disabled**, in accordance with the active connection to the TV set. Select this as **Wired Device** if you are connecting via an Ethernet cable.

Internet Speed Test

Highlight **Internet Speed Test** and press the **OK** button. TV will check the internet connection bandwidth and display the result when complete.

Advanced Settings

Highlight **Advanced Settings** and press the **OK** button. On the next screen you can change the IP and DNS settings of the TV. Highlight the desired one and press **Left** or **Right** button to change the setting from **Automatic** to **Manual**. Now you can enter the **Manual IP** and / or **Manual DNS** values. Select the related item in the drop down menu and enter the new values using the numeric buttons of the remote. Highlight **Save** and press the **OK** button to save settings when complete.

Wireless Connectivity

To Connect to a Wireless Network

The TV cannot connect to the networks with a hidden SSID. To make your modem's SSID visible, you should change your SSID settings via the modem's software.

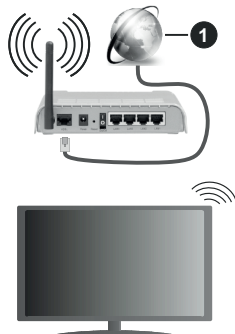

1. Broadband ISP connection

A Wireless-N router (IEEE 802.11a/b/g/n) with simultaneous 2.4 and 5 GHz bands is designed to increase bandwidth. These are optimized for smoother and faster HD video streaming, file transfers and wireless gaming.

- The frequency and channel differ depending on the area.
- The transmission speed differs depending on the distance and number of obstructions between the transmission products, the configuration of these products, the radio wave conditions, the line traffic and the products that you use. The transmission may also be cut off or may get disconnected depending on the radio wave conditions, DECT phones or any other WLAN 11b appliances. The standard values of the transmission speed are the theoretical maximum values for the wireless standards. They are not the actual speeds of data transmission.

- The location where the transmission is most effective differs depending on the usage environment.
- The Wireless feature of the TV supports 802.11 a,b,g & n type modems. It is highly recommended that you should use the IEEE 802.11n communication protocol in order to avoid any possible problems while watching videos.
- You must change your modem's SSID when there are any other modems around with the same SSID. You can encounter connection problems otherwise. Use a wired connection if you experience problems with a wireless connection.

Configuring Wireless Device Settings

Open the **Network** menu and select **Network Type as Wireless Device** to start connection process.

Highlight **Scan Wireless Networks** option and press **OK** to start a search for available wireless networks. All found networks will be listed. Highlight your desired network from the list and press **OK** to connect.

Note: If the modem supports N mode, you should set N mode settings.

If the selected network is password-protected, enter the correct key by using the virtual keyboard. You can use this keyboard via the directional buttons and the **OK** button on the remote control.

Wait until the IP address is shown on the screen.

This means that the connection is now established. To disconnect from a wireless network, highlight **Network Type** and press Left or Right buttons to set as **Disabled**.

If your router has WPS, you can directly connect to the modem/router without entering a password or adding the network first. Highlight **Press WPS on your wifi router** option and press **OK**. Go to your modem/router device and press the WPS button on it to make the connection. You will see a connection confirmation on your TV once the devices have paired. Select **OK** to proceed. No further configuration is required.

Highlight **Internet Speed Test** and press the **OK** button to check your internet connection speed. Highlight **Advanced Settings** and press the **OK** button to open the advanced setting menu. Use directional and numeric buttons to set. Highlight **Save** and press the **OK** button to save settings when complete.

Other Information

The status of the connection will be displayed as **Connected** or **Not Connected** and the current IP address, if a connection is established.

Connecting to your mobile device via WLAN

- If your mobile device has WLAN feature, you can connect it to your TV via a router, in order to access the content in your device. For this, your mobile device must have an appropriate sharing software.

Connect your TV to your router following the steps mentioned in the sections above.

Afterwards, connect your mobile device to the router and then activate the sharing software on your mobile device. Then, select files that you want to share with your TV.

If the connection is established correctly, you will be able to access the shared files installed on your mobile device via the AVS(audio video sharing) feature of your TV.

Highlight the **AVS** option in the **Sources** menu and press **OK**, available media server devices in the network will be displayed. Select your mobile device and press the **OK** button to continue.

- If available, you can download a virtual remote controller application from the server of your mobile device application provider.

Note: This feature may not be supported on all mobile devices.

Handling of the customer information

When using Internet connecting function of this TV, after agreeing to Panasonic's terms of service / privacy policy (hereinafter referred to as terms and conditions etc.), Customer Information on the use of this unit may be collected and used according to terms and conditions etc.

For details of terms of service / privacy policy, refer to **[HOME] Settings>Privacy Settings**

Customer's personal information may be recorded on this TV by broadcasting organisation or application provider. Before repairing, transferring or discarding this TV, erase all the information recorded on this TV according to the following procedure.

[HOME] Installation>First time installation

Customer information may be collected by provider via application provided by third parties on this TV or website. Please confirm the terms and conditions etc. of provide in advance.

- Panasonic will not be held responsible for collecting or using customer Information via application provided by third party on this TV or website.
- When entering your credit card number, name, etc., pay special attention to the trustworthiness of the provider.
- Registered information may be registered in the server etc. of provider. Before repairing, transferring or discarding this TV, be sure to erase the information according to the terms and conditions etc. of provider.

Wake ON

Wake-on-LAN (WoL) and Wake-on-Wireless LAN (WoWLAN) are standards that allow a device to be turned on or woken up by a network message. The message is sent to the device by a program executed

on a remote device connected to the same local area network, such as a smartphone.

Your TV is WoL and WoWLAN compatible. This feature might be disabled during the First Time Installation process. To enable this feature set the **Wake On** option in the **Network** menu as **On**. It is necessary that both the device, from which the network message will be sent to the TV, and the TV are connected to the same network. Wake On feature is only supported for Android OS devices and can only be used via YouTube and Netflix applications.

In order to use this feature the TV and the remote device should be connected at least once while the TV is on. If the TV is powered off, the connection should be re-established, the next time it is switched on. Otherwise this feature will be unavailable. This does not apply, when the TV is switched into the standby mode.

The performance of some devices in the market, may vary due to the software architecture. In order to use Wake On feature with a better performance, please make sure that your device has latest firmware version.

If you want your TV to consume less power in standby mode, you can disable this feature by setting the **Wake On** option as **Off**.

Connectivity Troubleshooting

Wireless Network Not Available

- Ensure that any firewalls of your network allow the TV wireless connection.
- Try searching for wireless networks again, using the **Network** menu screen.

If the wireless network does not function properly, try using the wired network in your home. Refer to the **Wired Connectivity** section for more information on the process.

If the TV does not function using the wired connection, check the modem (router). If the router does not have a problem, check the internet connection of your modem.

Connection is Slow

See the instruction book of your wireless modem to get information on the internal service area, connection speed, signal quality and other settings. You need to have a high speed connection for your modem.

Disruption during playback or slow reactions

You could try the following in such a case:

Keep at least three meters distance from microwave ovens, mobile telephones, bluetooth devices or any other WLAN compatible devices. Try changing the active channel on the WLAN router.

Internet Connection Not Available / Audio Video Sharing Not Working

If the MAC address (a unique identifier number) of your PC or modem has been permanently registered, it is

possible that your TV might not connect to the internet. In such a case, the MAC address is authenticated each time when you connect to the internet. This is a precaution against unauthorized access. Since your TV has its own MAC address, your internet service provider cannot validate the MAC address of your TV. For this reason, your TV cannot connect to the internet. Contact your internet service provider and request information on how to connect a different device, such as your TV, to the internet.

It is also possible that the connection may not be available due to a firewall problem. If you think this causes your problem, contact your internet service provider. A firewall might be the reason of a connectivity and discovery problem while using the TV in Audio Video Sharing mode or while browsing via Audio Video Sharing feature.

Invalid Domain

Ensure that you have already logged on to your PC with an authorized username/password and also ensure that your domain is active, prior to sharing any files in your media server program on your PC. If the domain is invalid, this might cause problems while browsing files in Audio Video Sharing mode.

Using Audio Video Sharing Network Service

Audio Video Sharing feature uses a standard that eases the viewing process of digital electronics and makes them more convenient to use on a home network.

This standard allows you to view and play photos, music and videos stored in the media server connected to your home network.

1. Server Software Installation

The Audio Video Sharing feature cannot be used if the server programme is not installed onto your PC or if the required media server software is not installed onto the companion device. Prepare your PC with a proper server programme.

2. Connect to a Wired or Wireless Network

See the **Wired/Wireless Connectivity** chapters for detailed configuration information.

3. Enable Audio Video Sharing

Enter the **Settings>System>More** menu and enable the **AVS** option.

4. Play Shared Files via Media Browser

Highlight the **AVS** option in the **Sources** menu by using the directional buttons and press **OK**. Available media server devices in the network will be listed. Select one and press **OK** to continue. The media browser will then be displayed.

Refer to the **Media Browser** menu section for further information on file playback.

If a problem occurs with the network, switch your television off at the wall socket and back on again.

Trick mode and jump are not supported with the Audio Video Sharing feature.

PC/HDD/Media Player or any other devices that are compatible should be used with a wired connection for higher playback quality.

Use a LAN connection for quicker file sharing between other devices like computers.

Note: *There may be some PC's which may not be able to utilize the Audio Video Sharing feature due to administrator and security settings (such as business PC's).*

Apps

You can access the applications installed on your TV from **Apps** menu. Highlight an app and press **OK** to launch.

In order to manage the apps installed on your TV, add new apps from the market or to see all available apps in full screen mode highlight the **Add More** option and press **OK**. Using this menu option you can add an installed app to **Home** menu, launch or remove it. Removed apps will no longer be accessible from **Apps** menu. You can also add new apps from the market. In order to enter the market highlight the shopping basket logo located on the upper left side of the screen and press **OK**. Available apps in the market will be displayed. Use directional buttons to highlight an app and press **OK**. Highlight **Add to Apps** option and press **OK** again to add the selected app to **Apps** menu.

For quick access to **Add More** menu you can press the **Internet** button on the remote, if this button is available.

Notes:

Possible application dependent problems may be caused by the content service provider.

Third party internet services may change, be discontinued or restricted at any time.

Freeview Play Platform

Freeview Play platform provides catch-up TV and On Demand services. Simply press the **Freeview Play** button on your remote control to connect to the Freeview Play platform.

The Freeview Play platform can also be accessed from the **Home** and **Apps** menus. Press **Menu** button and select **Home** or **Apps**. Then highlight **Freeview Play** and press the **OK** button.

You will have to agree to the terms and conditions for Freeview Play services first if you did not agree them during the **First Time Installation**. Highlight **Yes** and press **OK** on the remote to confirm and proceed.

Integrated TV Player applications will be displayed. Select one and press the **OK** button. Then select a content that you want to play back and press the **OK** button to watch.

Catch-up contents can also be accessed and played back directly from the TV Guide. Refer to the section **Electronic Programme Guide** for more information.

Requirements

The Freeview Play services may only be used if the following requirements are fulfilled:

- Connecting the TV to the internet. A minimum broadband speed of 2Mbps is required for proper operation of catch up and on demand services.
- Agreeing to the terms and conditions of Freeview Play

Note: *Freeview Play platform usage will count towards any monthly broadband data allowance. Only selected channels provide 7-day catch up.*

Internet Browser

To use the internet browser, enter the **Apps** menu first. Then launch the internet browser application which has an orange coloured logo with earth symbol on it.

In the initial screen of the browser, the thumbnails of the predefined (if any) links to web sites available will be displayed as **Speed Dial** options along with the **Edit Speed Dial** and the **Add to Speed Dial** options.

To navigate the web browser, use the directional buttons on the remote or a connected mouse. To see the browser options bar, move the cursor to the top of the page or press the **Back/Return** button. **History**, **Tabs** and **Bookmarks** options and the browser bar which contains previous/next buttons, the refresh button, the address/search bar, the **Speed Dial** and the **Vewd** buttons are available.

To add a desired website to the **Speed Dial** list for quick access, move the cursor to the top of the page or press the **Back/Return** button. The browser bar will appear. Highlight the **Speed Dial** -  button and press the **OK** button. Then select **Add to Speed Dial** option and press the **OK** button. Fill in the blanks for **Name** and **Address**, highlight **OK** and press the **OK** button to add. Whilst you are on the site you wish to add to the **Speed Dial** list, highlight the **Vewd** button and press the **OK** button. Then highlight **Add to Speed Dial** option in the submenu and press the **OK** button again. **Name** and **Address** will be filled automatically according to the site you are visiting. Highlight **OK** and press the **OK** button to add.

You can also use the **Vewd** menu options to manage the browser. Highlight the **Vewd** button and press the **OK** button to see available page specific and general options.

There are various ways to search or visit websites using the web browser.

Enter the address of a website(URL) into the search/address bar and highlight the **Submit** button on the virtual keyboard and press the **OK** button to visit the site.

Enter keyword/s into the search/address bar and highlight the **Submit** button on the virtual keyboard

and press the **OK** button to start a search for the related websites.

Highlight a Speed Dial thumbnail and press the **OK** button to visit the related website.

Your TV is compatible with USB mice. Plug your mouse or wireless mouse adaptor into the USB input of your TV for easier and quicker navigation.

Some web pages include flash content. These are not supported by the browser.

Your TV does not support any download processes from the internet via the browser.

All sites on the internet might not be supported. According to the site; content problems may occur. In some circumstances video contents might not be able to be played.

HBBTV System

HbbTV (Hybrid Broadcast Broadband TV) is a new industry standard that seamlessly combines TV services delivered via broadcast with services delivered via broadband and also enables access to Internet only services for consumers using connected TVs and set-top boxes. Services delivered through HbbTV include traditional broadcast TV channels, catch-up services, video-on-demand, electronic programme guide, interactive advertising, personalisation, voting, games, social networking and other multimedia applications.

HbbTV applications are available on channels where they are signalled by the broadcaster (currently various channels on Astra broadcast HbbTV applications). The broadcaster marks one application as "autostart" and this one is started by the platform automatically. The autostart applications are generally launched with a small red button icon to notify the user that there is an HbbTV application on that channel. Press the red button to open the application page. After the page is displayed you can go back to the initial red button icon state by pressing the red button again. You can toggle between the red button icon mode and full UI mode of the application via pressing red button. It should be noted that the red button switching capability is provided by the application and some application may behave differently.

If you switch to another channel while an HbbTV application is active (either in red button icon mode or full UI mode), the following scenarios can occur.

- The application can continue running.
- The application can be terminated.
- The application can be terminated and another autostart red button application can be launched.

HbbTV allows the applications to be retrieved both from broadband or broadcast. The broadcaster may enable both ways or one of them. If the platform does not have an operational broadband connection, the platform can still launch applications transmitted on broadcast.

The autostart red button applications generally provide links to other applications. The user then can switch to other applications by using the links provided. The applications should provide a way to terminate themselves, usually **Exit** button is used for this.

HbbTV applications use keys on the remote control to interact with the user. When an HbbTV application is launched, the control of some keys are owned by the application. For example, numeric channel selection may not work on a teletext application where the numbers indicate teletext pages.

HbbTV requires AV streaming capability for the platform. There are numerous applications providing VOD (video on demand) and catch-up TV services. The user can use play, pause, stop, forward, and rewind keys on the remote control to interact with the AV content.

*Note: You can enable or disable this feature from the **More** menu in **Settings>System** menu. Depending on the model of your TV and the selected country option in the **First Time Installation** this feature might be available in the **Settings>System>Privacy Settings** menu instead of the **Settings>System>More** menu.*

DVB functionality information

This DVB receiver is only suitable for use in the country which it was designed to be used in.

Although this DVB receiver conforms to the latest DVB specifications at the time of manufacture, we cannot guarantee compatibility with future DVB transmissions due to changes that may be implemented in broadcast signals and technologies.

Some digital television functions may not be available in all countries.

We continually strive to improve our products; therefore, specifications may change without prior notice.

For advice on where to purchase accessories, please contact the store where you purchased your equipment.

Important Instruction

For your own safety read following instruction carefully before attempting to connect this unit to the mains supply.

MAINS (AC) OPERATION

The wires in the mains lead are coloured in accordance with the following code :

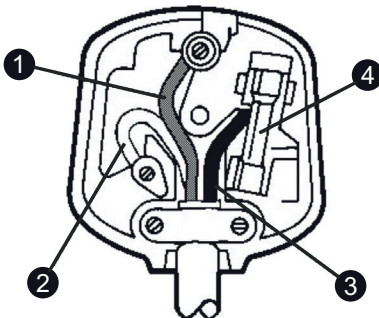

1. Green&Yellow (Earth) (if there is earth cable)
2. Blue (Neutral)
3. Brown (Live)
4. Fuse

IMPORTANT

As the colours of the wires in the mains lead of this appliance may not correspond with the coloured markings identifying the terminals in your plug, proceed as follows:

The wire which is coloured green and yellow must be connected to the terminal which is marked with the letter E, or by the earth symbol, or coloured green or green and yellow.

The wire which is coloured blue or black must be connected to the terminal which is marked with the letter N or coloured Black.

The wire which is coloured brown or red must be connected to the terminal which is marked with the letter L or coloured Red.

For continued protection against risk of fire, replace only with same type and rating of fuse (ASTA approved 5A 250VAC fuse).

CAUTION

TO PREVENT ELECTRIC SHOCK DISCONNECT FROM THE MAINS BEFORE REMOVING COVER. NO USER SERVICEABLE PARTS INSIDE. REFER SERVICING TO QUALIFIED SERVICE PERSONNEL.

SAFETY PRECAUTION

THIS EQUIPMENT MUST BE DISCONNECTED FROM THE MAINS WHEN NOT IN USE. DO NOT ALLOW THIS UNIT TO BE EXPOSED TO RAIN OR MOISTURE.