



BORN INNOVATIVE®

EN




Please read and follow these instructions carefully and operate the machine accordingly. This booklet provides important guidelines for safe use, installation, maintenance and some useful advice for best results when using your machine.

Keep all documentation in a safe place for future reference or for any future owners.

Please check that the following items are delivered with the appliance:

- Instruction manual
- Guarantee card
- Energy label

By placing the  mark on this product, we are confirming compliance to all relevant European safety, health and environmental requirements which are applicable in legislation for this product.

 Check that no damage has occurred to the machine during transit. If it has, call for service by GIAS. Failure to comply with the above can compromise the safety of the appliance. You may be charged for a service call if a problem with your machine is caused by misuse.

## Index

- 1. SAFETY REMINDERS**
- 2. PREPARING THE LOAD**
- 3. CLEANING AND ROUTINE MAINTENANCE**
- 4. WATER CONTAINER**
- 5. DOOR AND FILTER AND CONDENSER**
- 6. CONTROLS AND INDICATORS**
- 7. SELECTING THE PROGRAMME AND SET THE FUNCTION**
- 8. TROUBLESHOOTING CUSTOMER SERVICE**


## 1. SAFETY REMINDS

- This appliance can be used by children aged from 8 years and above and persons with reduced physical, sensory or mental capabilities or lack of experience and knowledge if they have been given supervision or instruction concerning use of the appliance in a safe way and understand the hazards involved. Children shall not play with the appliance. Cleaning and user maintenance should not be made by children without supervision. Children of less than 3 years should be kept away unless continuously supervised.
- **WARNING** Misuse of a tumble dryer may create a fire hazard.
- This appliances is intended to be used in household and similar applications such as:
  - Staff kitchen areas in shops , offices and other working environments;
  - Farm houses
  - By clients in hotels, motels and other residential type environments;
  - Bed and breakfast type environments. A different use of this appliance from house hold environment or from typical housekeeping functions, as commercial use by expert or trained users, is excluded even in the above applications.If the appliance is used in a manner inconsistent with this it

may reduce the life of the appliance and may void the manufacturer's warranty.

Any damage to the appliance or other damage or loss arising through use that is not consistent with domestic or household use ( even if located in a domestic or household environment) shall not be accepted by the manufacturer to the fullest extent permitted by law.

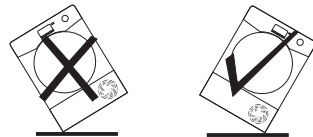
- This machine should only be used for its intended purpose as described in this manual. Ensure that the instructions for installation and use are fully understood before operating the appliance.
- Do not touch the appliance when hands or feet are damp or wet.
- Do not lean on the door when loading the machine or use the door to lift or move the machine.
- Do not allow children to play with the machine or its controls.

- **WARNING** Do not use the product if the fluff filter is not in position or is damaged; fluff could be ignited.
- **WARNING** Where the hot surface symbol is  located the temperature rise during operation of the tumble dryer may be in excess of 60 degrees C.
- Remove the plug from the electricity supply. Always remove the plug before cleaning the appliance.
- Do not continue to use this machine if it appears to be faulty.
- Lint and fluff must not be allowed to collect on the floor around the outside of the machine.
- The final part of a tumble dryer cycle occurs without heat (cool down cycle) to ensure that the items are left at a temperature that ensures that the items will not be damaged.
- The tumble dryer is not to be used if industrial chemicals have been used for cleaning.
- **WARNING:** Never stop a tumble dryer before the end of the drying cycle unless all items are quickly removed and spread out so that the heat is dissipated.
- Maximum load drying weight: see energy label.

## Installation

- Do not use adapters, multiple connectors and/or extensions.
- Never install the dryer against curtains and be sure to prevent items from falling or collecting behind the dryer.
- The appliance must not be installed behind a lockable door, a sliding door or a door with a hinge on the opposite side to that of the tumble dryer.

**Important:** During transport ensure that the dryer is in an upright position, if it's necessary you can only flip in the side shown;



**Caution:** If the product is in different side, wait at least 4 hours before switching on so that the oil can flow back into the compressor. Failure to do this could result in damage to the compressor.

## The Laundry

- Do not dry unwashed items in the tumble dryer.
- **WARNING** Do not tumble dry fabrics treated with dry cleaning fluids.
- **WARNING** Foam rubber materials can, under certain circumstances, when heated become ignited by spontaneous combustion. Items such as foam rubber (latex foam), shower caps, waterproof textiles, rubber backed articles and clothes or pillows fitted with foam rubber pads **MUST NOT** be dried in the tumble dryer.
- Always refer to the laundry care labels for directions on suitability for drying.
- Clothes should be spin dried or thoroughly wrung before they are put into the tumble dryer.
- Remove all objects from pockets such as lighters and matches.
- Clothes that are dripping wet should not be put into the dryer. Lighters and matches must not be left in pockets and **NEVER** use flammable liquids near the machine.
- Glass fibre curtains should **NEVER** be put in this machine. Skin irritation may occur if other garments are contaminated with the glass fibres.
- Items that have been soiled with substances such as cooking oil, acetone, alcohol,

petrol, kerosene, spot removers, turpentine, waxes and wax removers should be washed in hot water with an extra amount of detergent before being dried in the tumble dryer.

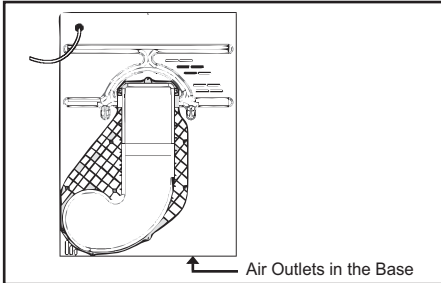
- Fabric softeners, or similar products, should be used as specified by the fabric softener instructions.

## Ventilation

- Adequate ventilation must be provided in the room where the tumble dryer is located to prevent gases from appliances burning other fuels, including open fires, being drawn into the room during operation of the tumble dryer.
- Installing the rear of the appliance close to a wall or vertical surface.
- There should be a gap of at least 12 mm between the machine and any obstructions. The inlet and outlet should be kept clear of obstruction. To ensure adequate ventilation the space between the bottom of the machine and the floor must not be obstructed.
- Check regularly that the air flowing through the dryer is not restricted.
- Check frequently the fluff filter after use, and clean, if necessary.

- Prevent items from falling or collecting behind the dryer as these may obstruct the air inlet and outlet NEVER install the dryer up against curtains.

⚠ If the supply cord is damaged, it must be replaced by the manufacturer, its service agent or similarly qualified persons in order to avoid a hazard.



**WARNING: The appliance must not be supplied through an external switching device, such as a timer, or connected to a circuit that is regularly switched on and off by a utility.**

⚠ Do not install the product in a low temperature room or in a room where there is a risk of frost occurring. At temperature around freezing point the product may not be able to operate properly: there is a risk of damage if the water is allowed to freeze in the hydraulic circuit (valves, hoses, pumps). For a better product performance the ambient room temperature must be between 5-35°C. Please note that operating in cold condition (between +2 and +5°C) might lead to some water condensation and water drops on the floor.

- The plug should be accessible for disconnection after the appliance has been installed.

## Instructions for mounting the furniture door

- **Regulate the height of the dryer**  
The 4 adjustable feet allow the height of the dryer to be adjusted from 827 mm to a maximum of 847 mm . To adjust the height, you should rotate the adjustable feet, ensuring that the machine is level (**figure 1**).

**Note** : we suggest to put the dryer at the maximum height possible in order to avoid tilting, leaving at least 5mm from the top of the furniture.

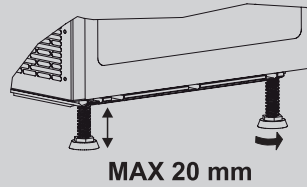
- Before fixing the hinges it's necessary to determine the depth of the dryer from the front part of the kitchen according to the depth of the kick plate (check picture) and chose the right installation option (**figure 2**).

### Option 1

The position of the plinth of the dryer is set back less than 54 mm from the front of the furniture.

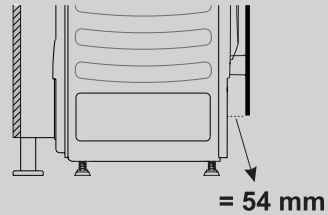
Position the template onto the reverse of the furniture door. It is possible to mount the hinges and closure magnet on the right or left-hand side depending on your requirements. Mark the screw hole positions, then drill out these positions (**figure 3**).

**Figure 1:**

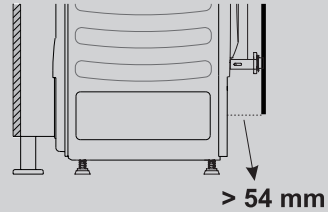


**Figure 2:**

#### Option 1:



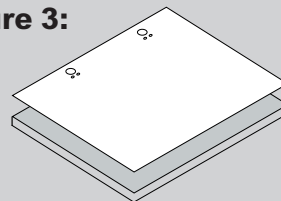
#### Option 2:



**Note:** That distance does not consider the thickness of the kickplate of the kitchen.

We suggest mounting the furniture door so that it opens towards the left, same direction as the porthole door.

**Figure 3:**



- Fix the hinges in place (on the door) with the 4 screws provided (A) (**figure 4**).

- Fix the magnet (B) in place using screw (C) (**figure 4**).

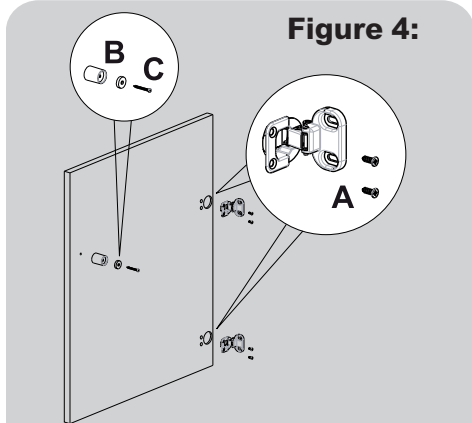
- Mount the plate (D) on the right or left-hand side, depending on your installation requirements (**figure 5**).

- Place the plastic support (E) under the plate and fix it in position with screw (F) (**figure 5**).

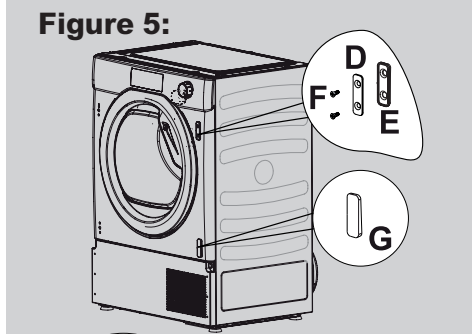
- Snap mount cap (G) in the lower position (**figure 5**).

- Mount the furniture door to the front of the dryer using the hinges. Place the spacers under the hinges (I) (**figure 6**) and then fix in position with screw (H).

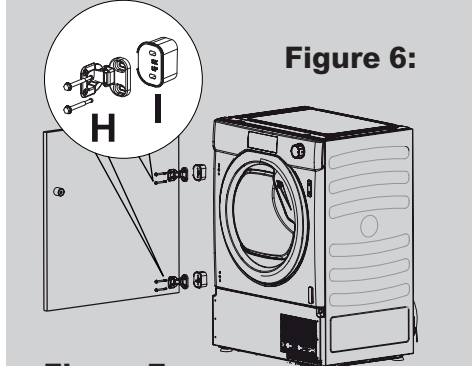
- Slide the dryer into an opening of the size indicated in the diagram (**figure 7**).



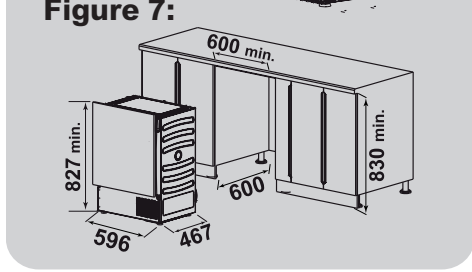
**Figure 4:**



**Figure 5:**



**Figure 6:**



**Figure 7:**



## Option 2

the position of the plinth is set back more than 55 mm from the front of the furniture.

**Note: components not supplied**  
**-hinges**  
**-supports**  
**-door stop**

- Firstly, slide the dryer into an opening of the size indicated in the diagram (**figure 7**).

Note: As soon as the hinges are fixed on the furniture it is not possible to slide the dryer in and out.

- Fix the door to the furniture with standard hinges and supports (not supplied) and stop the door with a std hook (not supplied) (**figure 8**).



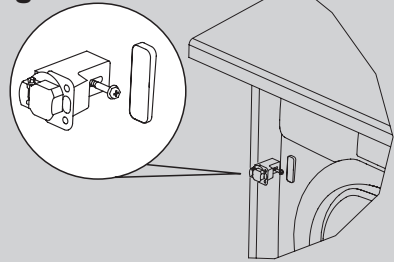
**Pay attention to position the bottom hinge 40 mm above the kick plate in order to facilitate its removal (figure 9).**

- Now it's possible to fix the hinges to the door of the furniture.
- Use the N° 4 mount caps (G) to cover all the holes on the front panel of the dryer.

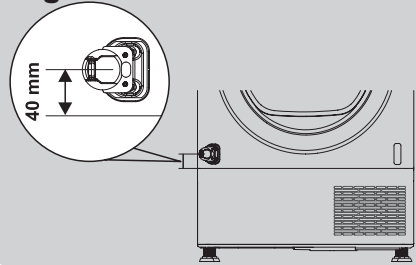
## GENERAL

- If the distance from the top of the dryer and the top of the furniture is more than 10 mm, fix the rear part of the dryer to N° 2 L metal brackets (K), in order to avoid tilting (**figure 10**).

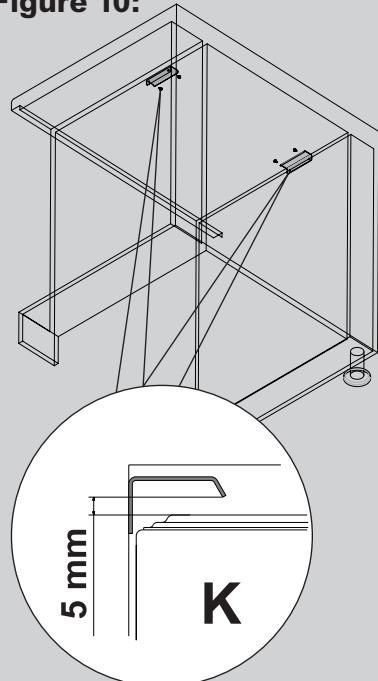
**Figure 8:**



**Figure 9:**



**Figure 10:**



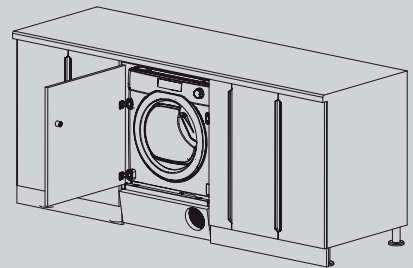
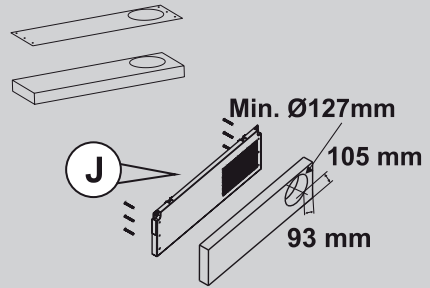
- A furniture plinth may be run across the front of the dryer, but its height will be dictated by the front kickplate.

**Plinth must have ventilation slots (min. Side/diameter 127mm hole) according to the dimensions on fixing template.**

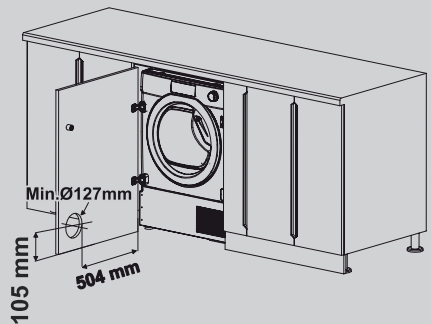
**If the plinth is not high enough to accommodate the whole hole, cut only part of it.**

- Place the template onto the reverse of plinth. Mark the screw hole positions, then drill out these positions (**figure 11**).
- Fix the plinth to the kickplate using 6 screws provided. (J)  
Note : it's possible only some types of kickplate (eg. wood or plastic) . We suggest to check with the kitchen supplier.
- Fix the kickplate to the dryer.
- In case of using full door, door must have min.  $\text{Ø}127\text{mm}$  hole across the slots of kickplate (**figure 12**).

**Figure 11:**



**Figure 12:**



**WITHOUT the airflow ventilation hole in the furniture door/plinth we cannot guarantee the correct functionality of the appliance.**

## Environmental Issues

- All packaging materials used are environmentally-friendly and recyclable. Please help dispose of the packaging via environmentally-friendly means. Your local council will be able to give you details of current means of disposal.
- To ensure safety when disposing of an old tumble dryer disconnect the mains plug from the socket, cut the mains power cable and destroy this together with the plug. To prevent children shutting themselves in the machine break the door hinges or the door lock.

## European Directive 2012/19/EU

This appliance is marked according to the European directive 2012/19/EU on Waste Electrical and Electronic Equipment (WEEE).



WEEE contains both polluting substances (which can cause negative consequences for the environment) and basic components (which can be re-used). It is important to have WEEE subjected to specific treatments, in order to remove and dispose properly all pollutants, and recover and recycle all materials.

Individuals can play an important role in ensuring that WEEE does not become an environmental issue; it is essential to follow some basic rules:

- WEEE should not be treated as household waste.
- WEEE should be handed over to the relevant collection points managed by the municipality or by registered companies. In many countries, for large WEEE, home collection could be present.

In many countries, when you buy a new appliance, the old one may be returned to the retailer who has to collect it free of charge on a one-to-one basis, as long as the equipment is of equivalent type and has the same functions as the supplied equipment.

## Service

- To ensure the continued safe and efficient operation of this appliance we recommend that any servicing or repairs are only carried out by an authorised GIAS service engineer.

## Electrical Requirements

Tumble dryers are supplied to operate at a voltage of 220-240V, 50 Hz single phase. Check that the supply circuit is rated to at least 6 A.

**Electricity can be extremely dangerous.**

**This appliance must be earthed.**

**The socket outlet and the plug on the appliance must be of the same type.**

**Do not use multiple adapters and/or extension leads.**



**Contains fluorinated greenhouse gases. Hermetically sealed.**

R134a / 0,260 [kg] / CO2 equivalent: 0,372[t] GWP1430



You may be charged for a service call if a problem with your machine is caused by incorrect installation.



Do not plug the machine in and switch it on at the mains until the installation is completed. For your safety, this dryer must be correctly installed. If there is any doubt about installation, call Service for advice.

## 2. PREPARING THE LOAD

Before using the tumble dryer for the first time:

- Please read this instruction book thoroughly.
- Remove all items packed inside drum.
- Wipe the inside of the drum and door with a damp cloth to remove any dust which may have settled in transit.


### Clothes Preparation

Make sure that the laundry you are going to dry is suitable for drying in a tumble dryer, as shown by the care symbols on each item.

Check that all fastenings are closed and that pockets are empty. Turn the articles inside out. Place clothes loosely in the drum to make sure that they don't get tangled.

### Do Not Tumble Dry:

Silk, nylon stockings, delicate embroidery, fabrics with metallic decorations, garments with PVC or leather trimmings.

 **IMPORTANT:** Do not dry articles which have been treated with a dry cleaning fluid or rubber clothes (danger of fire or explosion).

During the last 15 minutes the load is always tumbled in cool air.

### Energy Saving

Only put into the tumble dryer laundry which has been thoroughly wrung or spin-dried. The drier the laundry the shorter the drying time thus saving electricity.

#### ALWAYS

- Check that the filter is clean before every drying cycle.





#### NEVER

- Put dripping wet items into the tumble dryer, this may damage the appliance.

### Sort the Load as Follows

#### • By care symbols

These can be found on the collar or inside seam:

-  Suitable for tumble drying.
-  Tumble drying at high temperature.
-  Tumble drying at low temperature only.
-  Do not tumble dry.

If the item does not have a care label it must be assumed that it is not suitable for tumble drying.


#### • By amount and thickness

Whenever the load is bigger than the dryer capacity, separate clothes according to thickness (e.g. towels from thin underwear).

#### • By type of fabric

**Cottons/linen:** Towels, cotton jersey, bed and table linen.


**Synthetics:** Blouses, shirts, overalls, etc. made of polyester or polyamid, as well as for cotton/synthetic mixes.


 Do not overload the drum, large items when wet exceed the maximum admissible clothes load (for example: sleeping bags, duvets).


## 3. CLEANING AND ROUTINE MAINTENANCE

### Cleaning the Dryer


- Clean the filter and empty the water container after every drying cycle.
- Regularly clean the bottom filter.
- After each period of use, wipe the inside of the drum and leave the door open for a while to allow circulation of air to dry it.
- Wipe the outside of the machine and the door with a soft cloth.
- DO NOT use abrasive pads or cleaning agents.
- To prevent the door sticking or the build up of fluff clean the inner door and gasket with a damp cloth after every drying cycle.

 **WARNING!** The Drum, door and load may be very hot.

 **IMPORTANT** Always switch off and remove the plug from the electricity supply before cleaning this appliance.

 For electrical data refer to the rating label on the front of the dryer cabinet (with the door open).

## 4. WATER CONTAINER

The water removed from the laundry during the drying cycle is collected in a container inside the door of the dryer. When the container is full the  indicator on the control panel will light, and the container MUST be emptied. However, we recommend that the container is emptied after each drying cycle.

**NOTE:** Very little water will collect during the first few cycles of a new machine as an internal reservoir is filled first.

### To remove the container tank in door drawer

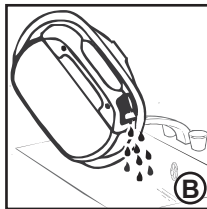
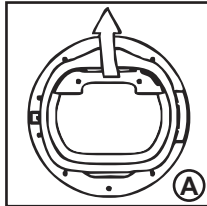
1. Gently pull out the water container holding the handle. (A)

**When it is full the water container will weigh about 6 kg.**

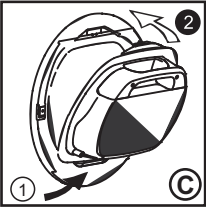
2. Tilt the water container to empty the water out through the spout. (B)

When empty, replace the water container back as shown; (C) first insert the base of the container into position as shown (1) then gentle push the top into position (2).



3. Press  Button to restart the cycle.




**NOTE:** If you have the option of drainage near to the dryer you can use the discharge kit to provide a permanent drainage for the water collected in the container of the dryer. This means that you don't have to empty the water container.



### OPERATION

1. Open the door and load the drum with laundry. Ensure that garments do not hinder closure of the door.
2. Gently close the door pushing it slowly until you hear the door 'click' shut.
3. Turn the Programme Selector dial to select the required drying programme (see Programme Guide).
4. Press the  button. The dryer will start automatically and the indicator above the button will be continuously lit.
5. If the door is opened during the programme to check the laundry, it is necessary to press  to recommence drying after the door has been closed.
6. When the cycle is nearing completion the machine will enter the cool down phase, the clothes will be tumbled in cool air allowing the load to cool down.
7. Following the completion of the cycle the drum will rotate intermittently to minimize creasing. This will continue until the machine is switched OFF or the door is opened.
8. When the programme is complete the END indicator will light.

 Do not open the door during the automatic programs in order to obtain a good drying result.

## 5. DOOR and FILTER

Pull on handle to open the door.

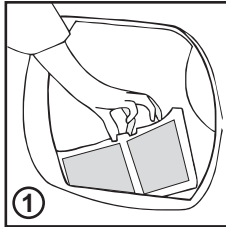
To restart the dryer, close the door and press Start/ Pause button. ▶|||

**⚠ WARNING!** When the tumble dryer is in use the drum and door may be VERY HOT.

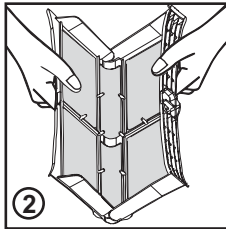
### Filter

**IMPORTANT:** To maintain the efficiency of the dryer check that the fluff filter is clean before each drying cycle.

1. Pull the filter upwards.



2. Open filter as shown.



3. Gently remove lint using a soft brush or your fingertips.

4. Snap the filter together and push back into place.

### Filter Care Indicator

**🌐** Lights when the filter needs cleaning.

If the laundry is not drying check that the filter is not clogged.

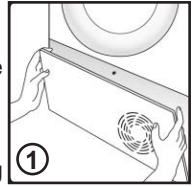
**⚠ IF YOU CLEAN THE FILTER UNDER WATER, REMEMBER TO DRY IT.**

**⚠ WARNING!** If you open the door mid cycle, before the cool-down cycle has completed, the handle may be hot. Please use extreme caution when attempting to empty the water reservoir during the cycle.

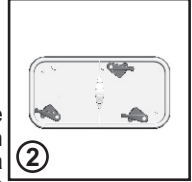
**⚠** Please pay attention that overloading or bulky load can lead to door opening, in this case please reduce the load capacity to continue the drying cycle.

### To Clean the Condenser Filter

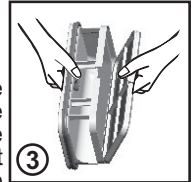
1. Remove the kickplate.



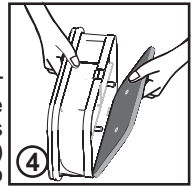
2. Turn the two locking levers anti-clockwise and pull out the front cover.



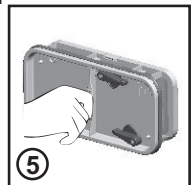
3. Gently remove the filter frame and clean any dust or fluff with a cloth from the filter. Do not use water to clean the filter.



4. Remove the sponge gently from its place and then wash the sponge by holding it under a running tap turning it so to remove any dust or fluff.



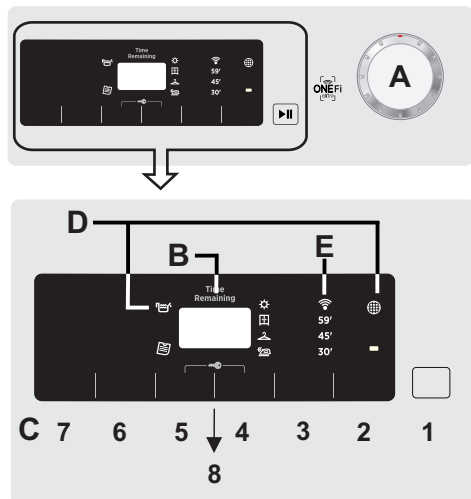
5. Refit the front cover ensuring it is in the correct way (as indicated by the arrow) and pushed firmly into place. Lock the two levers by turning them clockwise.



6. Refit the kickplate.

**⚠ Clean the filters before every cycle.**

## 6. CONTROLS AND INDICATORS



**A-Programme Selector** - Rotating the knob in both directions it's possible to select the desired drying program. To cancel the selections or switch off the dryer rotate the knob to OFF.

**B- Display Digit** - The display shows the remaining time for drying, the time until a drying cycle will start (if delayed start has been activated) and other notifications setting.

### C-Buttons -

#### 1.Start/Pause Button

To start the selected program and/or suspend it.

#### 2.Best Ironing

This option reduces folds and tangles, thanks to alternating movements of the drum during and after drying and automatically, setting the iron drying level (the drying level setting can be modified after the option selection).

The option can be set up to five minutes after the start of the cycle and is activated only on automatic cycles.

#### 3.Rapids Button

It's possible switch an automatic program to RAPID program, up to 3 minutes after the start of the cycle. The progressive pressure increases the time (30-45-59 minutes).

After this selection to reset the automatic drying functioning it is necessary to switch off the dryer. In case of incompatibility, all LEDs flash quickly 3 times.

#### 4 Drying Selection Button

This allows you to select the required dryness level, it is possible to choose for up to five minutes after the start of a drying cycle:

- **Ready to Iron** : It leaves the garments slightly wet to facilitate ironing.

- **Hanger Dry** : To make garment ready to be hung on a coat hanger.

- **Wardrobe Dry** : For laundry that can be directly stored.

- **Extra-dry** : To get completely dry garments, ideal for full load.

This appliances is equipped with a Drying Manager Function. On automatic cycles, each level of intermediate drying, prior to the reaching the selected one, is indicated by a flashing neon that indicates the degree of dryness that the garments have reached. In case of incompatibility, all LEDs flash quickly for 3 times.

#### 5.Delay Start Button

It allows to delay the start of the program from 1 to 24 hours in 1-hour intervals. The delay selected is shown on the display.

After pressing the START button the time showed decreases hour by hour.

If you open the porthole door with delayed start set, after re-closing the porthole, press start again to resume the counting.

#### 6.Memory

This option allows you to store the options set on a cycle.

**STORAGE** When the cycle is running, push the button "memory" for three seconds. The control light "memory" flashes for three times and stores the set options connected to the cycle currently in progress.

**Recall:** After the selection of the cycle Push the button "memory" for recall the stored options. (not the cycle).

#### 7.Time cycle selection

It's possible to transform a cycle from automatic to programmed, up to 3 minutes after the start of the cycle.

The progressive pressure increases the time in 10-minute intervals. After this selection to reset the automatic drying functioning it is necessary to switch off the dryer. In case of incompatibility, all LEDs flash quickly for 3 times.

#### 8. Keylock

This function allows to block unwanted changes of the set options on the bezel, during drying phase. Activation/Inactivation: Push 4 and 5 buttons simultaneously for two seconds. The sign "LOC" appears on the display. Unlocking the option, on the display appears the sign "Unl", only once. In case of opening of 'porthole' with activated key lock, the cycle stops but the lock is kept: to restart the cycle, you must remove the lock and restore Start. When the dryer is off, the option is automatically inactivated.

Key lock can be modified at any time of the cycle.


### Automatic Anti crease

This option automatically activates an anti-crease movement of the drum, pre cycle in case of activation of the delay and at the end of drying cycle for 6 hours. It is activated every 10 minutes. To stop the movements set the knob to OFF

Useful when it's not possible to remove immediately the laundry.

### D- Led

**Water tank**  - It lights up when it's necessary to empty the condensate water tank.

**Filter cleaning**  - It lights up when the cleaning of the filters is requested (the door and the lower filter.)

### E- WI-FI (some models only)

In the models with the Wi-Fi option, the icon indicates that the Wi-Fi system is working.

**ONE Fi EXTRA area** - There is an apposite place in the bezel on which lay the smartphone during the enrollment of the machine to the APP. Follow the indications on the phone display. ( only for Android smartphone equipped with NFC technology)




APPAREL CARE

The wool drying cycle of this machine has been approved by The Woolmark Company for the drying of machine washable wool products provided that the products are washed and dried according to the instructions on the garment label and those issues by the manufacturer of this machine M1530.

In UK, Eire, Hong Kong and India the Woolmark trade mark is a Certification trade mark.

Maximum Drying Weight	
Cottons	Max.capacity declared
Synthetics or Delicates	Max.4 Kg

### Drying Guide

The standard cycle COTTON DRY () is the most energy efficient and best suited for drying normal wet cotton laundry.

The table in last page shows the approximate time and energy consumption of the main drying programmes.

Power consumption of off-mode	0,40 W
Power consumption of on-mode	0,75 W

### Technical Specifications


Drum capacity	78,5
Maximum load	See energy label
Height	85 cm
Width	60 cm
Depth	48,7 cm
Energy class	See energy label

### Information for Test Laboratory

#### EN 61121 Programme To Use

- DRY COTTON	-  COTTON OR 
- IRON DRY COTTON	- COTTON OR WHITES 
- EASY-CARE TEXTILE	- DELICATES OR SYNTHETIC





#### Clean the filters before every cycle

 The real duration of drying cycle depends by the starting humidity level of the laundry due to spin speed, type and amount of load, cleanliness of filters and ambient temperature.



## 7. SELECTING THE PROGRAMME AND SET THE FUNCTION

(To check programmes and options compatibility refer to next page).

PROGRAM	PROGRAM DESCRIPTION	CAPACITY (kg)	DRYING TIME (min)
All In One 	A new innovative cycle to dry different kinds of fabrics in the same time. The dryer provides an alert when the lightweight fabrics are dry and ready to be taking out. After this step it's necessary to press start again to complete the drying for the leftovers heavier linens.	5	*
Darks & Coloured	A delicate and specific cycle to dry dark or coloured cotton or synthetics garments.	4	*
Whites	The right cycle to dry cottons, sponges and towels.	Full	*
 Cotton	Program Eco normative (hang dry) drying. The most efficient program in energy consumption. Suitable for cottons and linens.	Full	*
Shirts	This specific cycle has been conceived to dry shirts minimizing tangles and folds thanks specific movements of the drum. It's recommended to take out the linens immediately after drying cycle.	2.5	*
Jeans	Dedicated to dry uniform fabrics like jeans or denim. It's recommended flip over the garments before drying.	4	*
Synthetics	To dry delicate and synthetic fabrics that need an accurate and specific treatment.	4	*
Waterproof Revitalize	An special service to revitalize the waterproofing treatment of the linens.	2	*
Sports	Dedicated to technical garments for sport and fitness, drying gently with special care to avoid shrinking and deterioration of elastic fibers.	4	*
Down Jackets	Perfect cycle to dry duvets and revitalizing the smoothness smoothness of the feathers.	4	*
 Wool	Woolen clothes: the program can be used to dry up to 1 kg of laundry (around 3 jumpers). It is recommended to reverse all clothes before drying. Timing can change due to dimensions and thickness of load and to spinning chosen during washing. At the end of the cycle, clothes are ready to be worn, but if they are heavier, edges can be a bit wet: it is suggested to dry them naturally. It is recommended to unload clothes at the very end of the cycle. Attention: felting process of wool is irreversible; please dry exclusively clothes with symbol (symbol "ok tumble"); this program is not indicated for acrylic clothes.	1	70'
Antiallergy	One specific cycle that dry and in the same time helps to reduce the main allergens such as dustmites, pet hair, pollens and residual of powder detergents.	4	Max 220'
XXL Load	Specific cycle dedicated to dry oversized linen like curtains, sheets and tablecloths. Thanks to a specific movement of the drum the linens will be dry minimising tangles and folds.	5	Max 220'
Anti Odours	The perfect cycle to remove the smells from the linens smoothing creases.	2.5	20'
 One Fi Extra	Position that you have to select when you want to enable remote control through the App (via Wi-Fi). For more details, see paragraph One Fi Extra		

\*The real duration of drying cycle depends by the starting humidity level of the laundry due to spin speed, type and amount of load, cleanliness of filters and ambient temperature.

## PROGRAMMES AND OPTIONS COMPATIBILITY

PROGRAMMES	SELECTABLE OPTIONS						AUTOMATIC OPTIONS	
	Rapids cycle	Time selection	Drying selection	Best Ironing	Delay Start	Memory	Automatic Anti crease	Drying Manager
All In One	-	-	-	-	✓	-	-	-
Darks & Coloured	-	-	✓	✓	✓	✓	✓	✓
Whites	✓	✓	✓	✓	✓	✓	✓	✓
Cotton	-	-	-	-	✓	-	-	-
Shirts	✓	-	✓	✓	✓	✓	✓	✓
Jeans	-	-	-	✓	✓	✓	✓	✓
Synthetics	✓	✓	✓	✓	✓	✓	✓	✓
Waterproof Revitalize	✓	-	-	-	✓	✓	-	-
Sports	-	-	✓	-	✓	✓	✓	✓
Down Jackets	-	-	-	-	✓	-	✓	✓
Wool	-	-	-	-	✓	-	-	-
Antiallergy	-	✓	-	-	✓	✓	✓	-
XXL Load	-	✓	✓	✓	✓	✓	✓	✓
Anti Odours	-	-	-	-	✓	-	✓	-

## ONE FI EXTRA

This appliance is equipped with **ONE Fi EXTRA** technology that allows you to control it remotely via App, thanks to Wi-Fi function.

### MACHINE ENROLLMENT (ON APP)

- Download the **Hoover Wizard** App on your device.

The Hoover Wizard App is available for devices running both Android and iOS, both for tablets and for smartphones.

Get all the details of the ONE Fi EXTRA functions by browsing the App in DEMO mode.

- Open the App, create the user profile and enroll the appliance following the instructions on the device display or the **"Quick Guide"** attached on the machine.

Using an Android smartphone equipped with NFC technology (Near Field Communication), the enrollment process is simplified (Easy Enrollment); in this case, follow the instructions on the phone display, **PLACE AND KEEP IT NEAR** the ONE Fi EXTRA logo on the machine dashboard, when requested to do so by the App.



### NOTES:

Place your smartphone so that the NFC antenna on its back matches the position of the ONE Fi EXTRA logo on the appliance (as illustrated below).



If you do not know the position of your NFC antenna, slightly move the smartphone in a circular motion over the ONE Fi EXTRA logo until the App confirms the connection. In order for the data transfer to be successful, it is essential **TO KEEP THE SMARTPHONE ON THE DASHBOARD DURING THESE FEW SECONDS OF THE PROCEDURE**; a message on the device will inform about the correct outcome of the operation and advise you when it is possible to move the smartphone away.

**Thick cases or metallic stickers on your smartphone could affect or prevent the transmission of data between machine and telephone. If necessary, remove them.**

**The replacement of some components of the smartphone (e.g. back cover, battery, etc...) with non-original ones, could result in the NFC antenna removal.**

**ENABLE REMOTE CONTROL (VIA APP)** After the machine enrollment, every time you want to manage it remotely through the App, firstly you have to load the laundry, close the door and select the **ONE Fi EXTRA** position on the machine. From that moment on you can manage it through the App commands.

**NOTE :** In case of door opening with remote control on, to restore the connection with the App, close the porthole and press start. The cycle will resume from where it stopped.


## WIRELESS PARAMETERS

Parameter	Specifications
Wireless Standard	802.11 b/g/n
Frequency range	2,412 GHz - 2,484 GHz
Max Transmit Power	802.11b (11Mbps) +18,5 ± 2 dBm
	802.11g (54Mbps) +16 ± 2 dBm
	802.11n (HT20, MCS7) +14 ± 2 dBm
Minimum Receiving Sensitivity	802.11b (11Mbps) -93 dBm
	802.11g (54Mbps) -85 dBm
	802.11n (HT20, MCS7) -82 dBm
	-82 dBm

## 8. TROUBLESHOOTING

### WIRELESS PARAMETERS

Parameter	Specifications
Wireless Standard	ISO/IEC 14443 Type A and NFC Forum Type 4
Frequency band	13,553-13,567 MHz (centre frequency 13,560 MHz)
Magnetic field limit	< 42dBµA/m (at 10 meters)

With this the Candy Hoover Group Srl, declares that this appliance marked with  complies with the essential requirements of the Directive 2014/53/EU. To receive a copy of the declaration of conformity, please contact the manufacturer at: [www.candy-group.com](http://www.candy-group.com)

#### What Might be the Cause of...

##### Defects you can remedy yourself

Before calling service for technical advice please run through the following checklist. A charge will be made if the machine is found to be working or has been installed incorrectly or used incorrectly. If the problem persists after completing the recommended checks, please call Service, they may be able to assist you over the telephone.

**Time display to end could change during drying cycle. The time to end is continuously checked during the drying cycle and the time is adjusted to give the best estimation time. The displayed time may increase or decrease during the cycle and this is normal.**

##### Drying time is too long/clothes are not dry enough...

- Have you selected the correct drying time/programme?
- Were the clothes too wet? Were the clothes thoroughly wrung or spindried?
- Does the filter need cleaning?
- Is the dryer overloaded?

##### The dryer does not operate...

- Is there a working electricity supply to the dryer? Check using another appliance such as a table lamp.
- Is the plug properly connected to the mains supply?

- Is there a power failure?
- Has the fuse blown?
- Is the door fully closed?
- Is the dryer switched on, both at the mains supply and at the machine?
- Has the drying time or the programme been selected?
- Has the machine been switched on again after opening the door?

##### The dryer is noisy...

- Switch off the dryer and contact GIAS Service for advice.

##### The Indicator is on...

- Does the filter need cleaning?

##### The Indicator is on...

- Does the water container need emptying?

### CUSTOMER SERVICE

Should there still be a problem with your dryer after completing all the recommended checks, please call service for advice.

They may be able to assist you over the telephone or arrange for a suitable appointment for an engineer to call under the terms of your guarantee. However, a charge may be made if any of the following applies to your machine:

- Is found to be in working order.
- Has not been installed in accordance with the installation instructions.
- Has been used incorrectly.

#### Spares

Always use genuine spares, available direct from service.

#### Service

For service and repairs call your local service engineer.

**The manufacturer declines all responsibility in the event of any printing mistakes in this booklet. The manufacturer also reserves the right to make appropriate modifications to its products without changing the essential characteristics.**







Energy



Capacity



Time



	<b>Capacity (kg)</b>		7
	<b>Class</b>		A+
☼ Whites	Energy	kWh	2,83
	Time	Min.	302
☼ Whites	Energy	kWh	2,62
	Time	Min.	278
☐ Cotton	Energy	kWh	2,25
	Time	Min.	244
☐ Cotton ½	Energy	kWh	1,20
	Time	Min.	140
☼ Whites	Energy	kWh	1,76
	Time	Min.	194



40012253.A