



HOVER



USER MANUAL

IMPORTANT SAFETY REMINDERS

This appliance should only be used for domestic cleaning, as described in this user guide. Please ensure that this guide is fully understood before operating the appliance.

Do not leave the appliance plugged in. Always switch off and remove the plug from the socket after use, or before cleaning the appliance or any maintenance task.

This appliance can be used by children aged from 8 years and above and persons with reduced physical, sensory or mental capabilities or lack of experience and knowledge if they have been given supervision or instruction concerning use of the appliance in a safe way and understand the hazards involved. Children shall not play with the appliance. Cleaning and user maintenance shall not be made by children without supervision.

If the power cord is damaged stop using the appliance immediately. To avoid a safety hazard, an authorised Hoover service engineer must replace the power cord.

Keep hands, feet, loose clothing and hair away from rotating brushes.

Use only attachments, consumables or spares recommended or supplied by Hoover.

When using cleaning tools ensure that the appliance is kept in the upright (parked) position. This will avoid possible damage to the carpet or floor covering. When cleaning stairs, do not position the appliance above you.

Static electricity: some carpets can cause a small build up of static electricity. Any static discharge is not hazardous to health.

Do not use your appliance out of doors or on any wet surface or for wet pick up.

Do not pick up hard or sharp objects, matches, hot ashes,

cigarette ends or other similar items.

Do not spray with or pick up flammable liquids, cleaning fluids, aerosols or their vapours.

Do not run over the power cord when using your appliance or remove the plug by pulling on the power cord.

Do not continue to use your appliance if it appears faulty.

Hoover service: To ensure the continued safe and efficient operation of this appliance we recommend that any servicing or repairs are only carried out by an authorised Hoover service engineer.

Do not stand on or wrap the cord around arms or legs when using your appliance.

Do not use the appliance to clean animals or people.

When using the cleaning tools, ensure to always steady the appliance with your other hand. This will ensure that the appliance does not fall while in use.

The Environment

The symbol on this appliance indicates that this appliance may not be treated as household waste. Instead it must be handed over to the applicable collection point for the recycling of electrical and electronic equipment. Disposal must be carried out in accordance with local environmental regulations for waste disposal. For more detailed information about treatment, recovery and recycling of this appliance, please contact your local city office, your household and waste disposal service or the shop where you purchased the appliance.



 This appliance complies with the European Directives 2014/35/EU, 2014/30/EU and 2011/65/EU.

CANDY HOOVER GROUP S.r.l. Via Privata Eden Fumagalli, 20861 Brugherio (MB) Italy

GETTING TO KNOW YOUR CLEANER

Effortless cleaning
with your new
Hoover

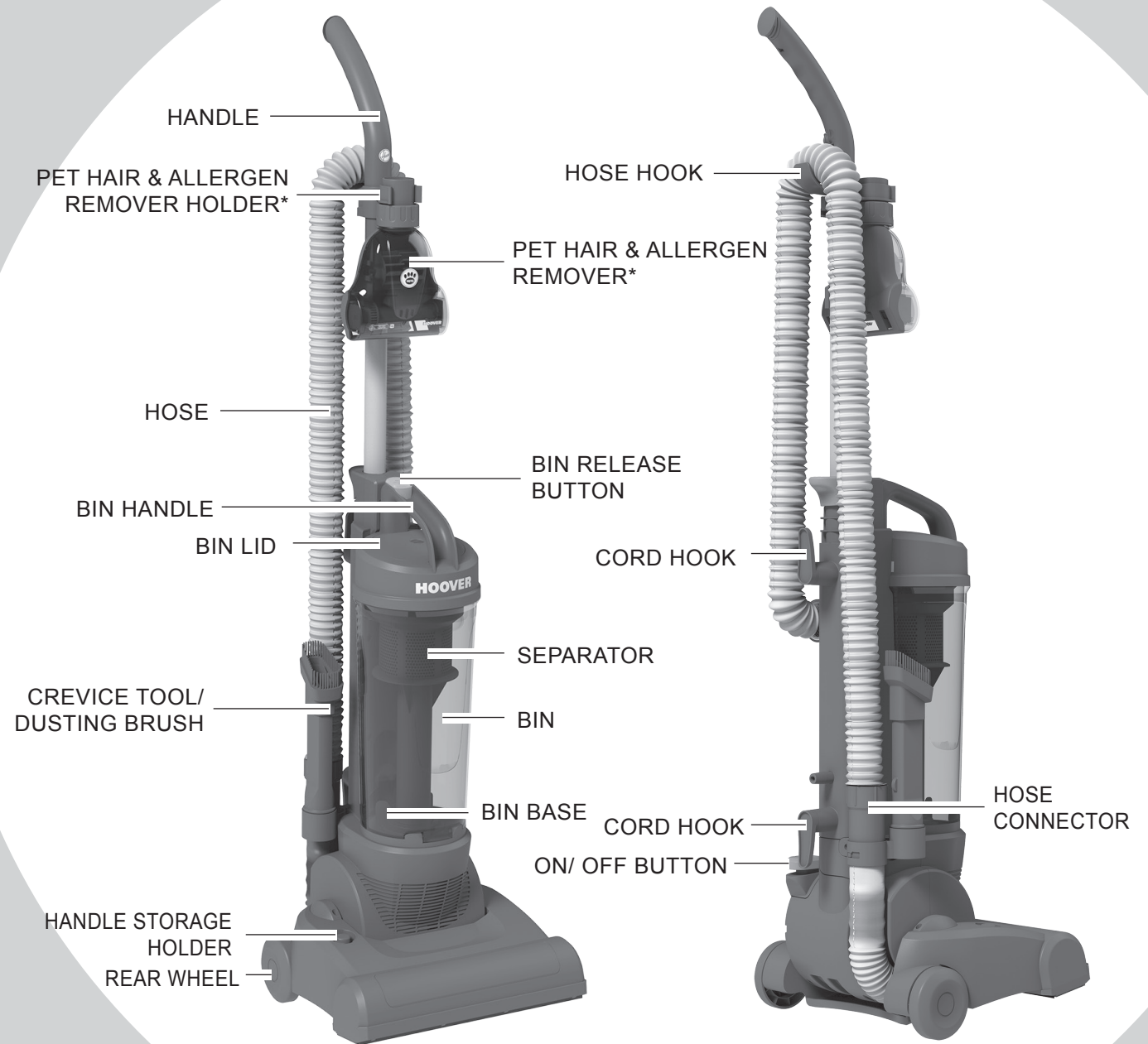

(*Certain models only)

PREPARING TO USE YOUR CLEANER

1. Insert the handle into the main body of the cleaner.

2. Place the crevice tool / dusting brush into the tool holder.

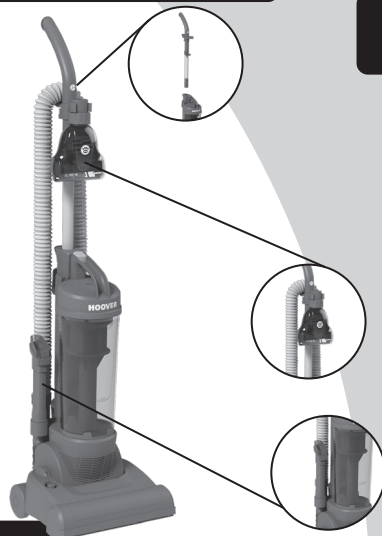

POWER SWITCH SETTING

Switching on and off

1. Plug cord into an electrical outlet.
2. Press the on /off switch to operate cleaner.

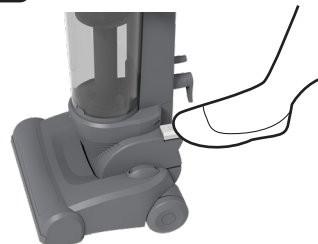

CLEANER RELEASE

Unlock the cleaner by placing your foot on the hood and leaning the handle backward. For cleaning under low furniture simply lower handle to floor.



CLEANING TOOLS

! IMPORTANT: When using cleaning tools, the cleaner must be kept in the upright position, particularly when cleaning stairs.

To Detach the cleaning hose rotate the hose end anti-clockwise and pull upwards.

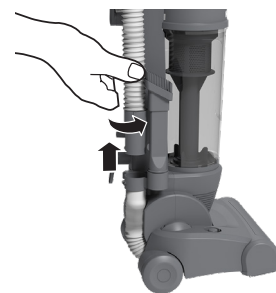

Attach crevice tool to the hose end connector.

To use the dusting brush function simply press the button and slide to the end of crevice tool .

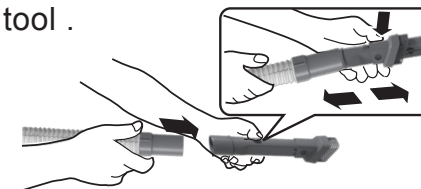

Fit the Pet Hair & Allergen Remover*

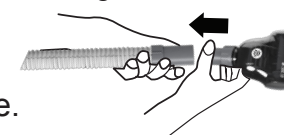

All accessories can fit on the end of the tube.

CLEANING THE STAIRS

IT IS DANGEROUS TO PLACE THE CLEANER ABOVE YOU WHEN CLEANING STAIRS.

ALWAYS work with the cleaner below you. Ensure it is positioned up against the bottom step.

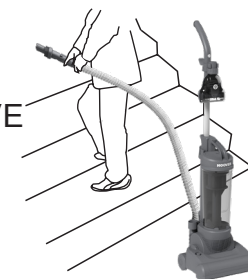

WIPER BLADE ASSEMBLY

- 1 To obtain the best performance and efficiency, it is recommended to assemble the front and back wiper blade to the soleplate of the nozzle.

Grip the inserted side of the wiper blade and slide along the slot until the wiper blade is fully located.

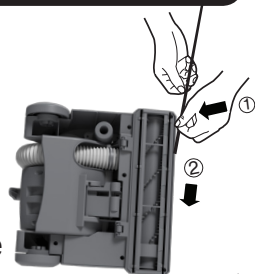

- 2 To get a lower push force on the nozzle, you can disassemble the wiper blade. lift the end of the wiper blade and pull it out.

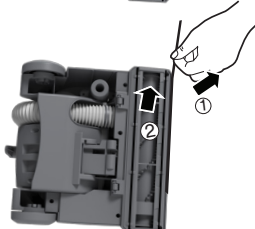

REMOVAL AND EMPTYING OF THE DUST CONTAINER



To remove the dust container from the cleaner, press the bin release button.



Hold the container over a bin and push the easy open button placed at the rear of the dust container.

(*Certain models only)



The dust container door will open and you can empty with no contact with dust.

! IMPORTANT: Do not fill above the MAX level mark shown on the bin.

MAX

HANDLE STORAGE

Remove the hose from the hose hook, and release the hose.

Push the handle release button, then lift the handle assembly upward.

Insert the tube to the handle storage holder.

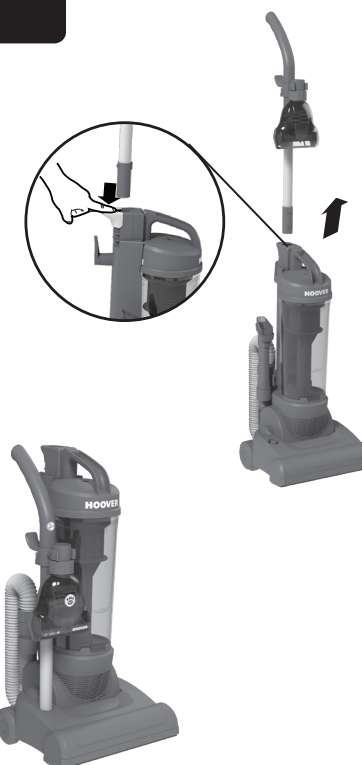

MAINTAINING THE DUST CONTAINER AND FILTERS

(PERIODIC MAINTENANCE IS REQUIRED TO MAINTAIN OPTIMUM PERFORMANCE)

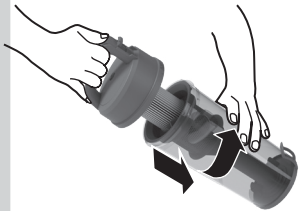

Remove the dust container as described on the previous page.

Hold the dust container lid and with the other hand rotate the container in a anti-clockwise direction to release.



Hold the pre-motor filter, then rotate the bin lid with anti-clockwise direction.

After the pre-motor filter is detached, pull it out.

The pre-motor filter should be washed after every 3 bin empties. Wash under hand warm water. Remove excess water and leave to dry for 24 hours.

When completely dry, refit the filter.

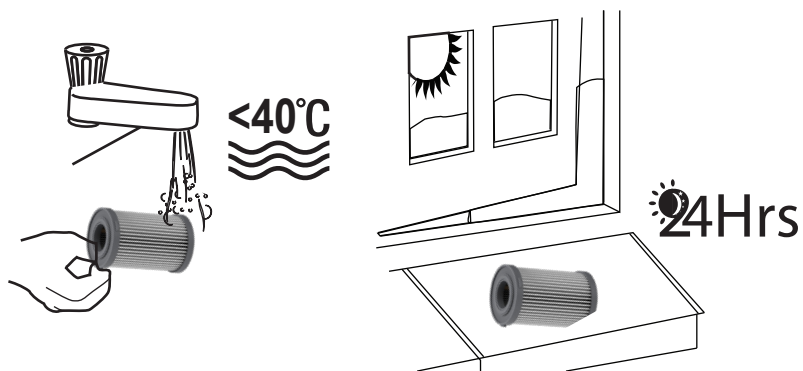

Cleaning the Separator

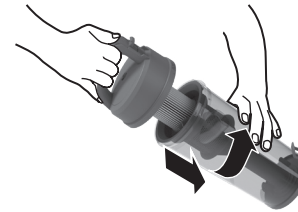

Turn the dust container lid anti-clockwise to unlock and lift to take out.

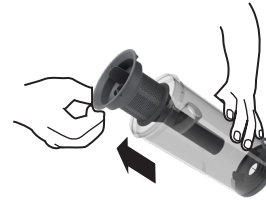

Lift the separator out from the bin.



Tap the separator over a bin to remove any dirt/debris.

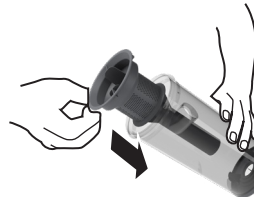

Refit the separator and the bin lid.

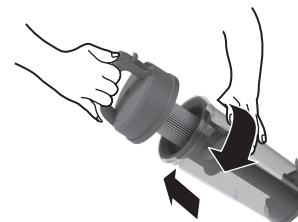

Whilst holding the lower part to lock together and twist the bin lid

CHANGING THE BELT OR BRUSH

If your cleaner is not picking up efficiently, the belt or brush (or both) may need replacing, but first make sure you have:

- Emptied the dust container
- Cleaned the filters
- Checked for blockages

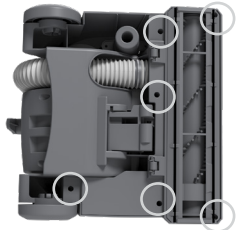

Remove foot plate

Turn the machine over.
Locate the 6 screws as shown opposite.

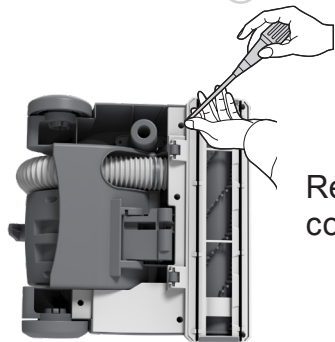

Remove the screws completely.

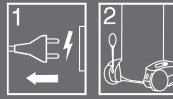

IMPORTANT: Switch cleaner off and remove plug from electricity supply before checking the brushes or removing hood.

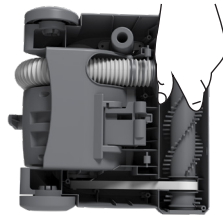

Replace belt

Remove the old belt then locate the new belt around the motor spindle and the brush. Locate the right hand of the brush into the cleaner housing .

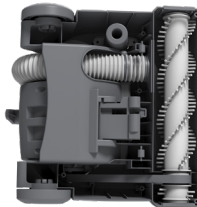

Hold the brush assembly and stretch the belt until brush mountings slot down into the cleaner housing.

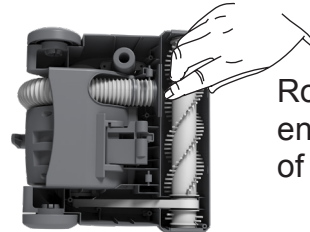

Rotate the brush to ensure free movement of the belt.

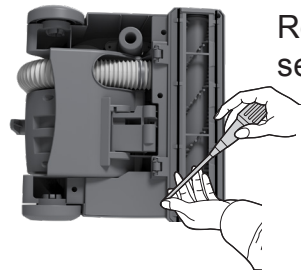

Replace opposite

Refit sole plate opposite secure with screws.

CLEARING A BLOCKAGE

! **IMPORTANT:** Switch the cleaner off and remove the plug from electricity supply before dismantling cleaning.

This cleaner is unlikely to become blocked, except by overfilling of dust container or accidentally picking up large solid objects. Cleaning a blockage is simple.

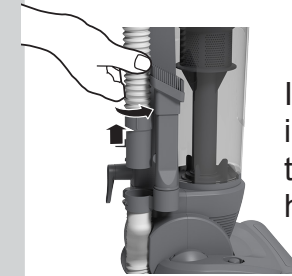

If cleaning tools were in use, check cleaning tool. Next check hose handgrip.

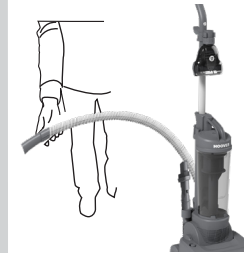

Turn the cleaner ON and stretch the hose to its full length.

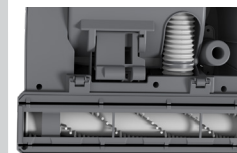

Check that the brushes are free of debris and can rotate.

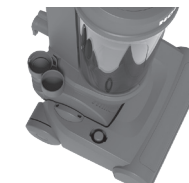

Check for a blockage in the hose socket.

User checklist

If your cleaner is not working properly run through the following checklist.

1. Is there a working electricity supply to the cleaner? Check with another electrical product.
2. Is the dust container full or choked with fine dust? To empty the dust container see the instructions on page 5/6.
3. Is the hose blocked? To clear a blockage, see the instructions on page 6.
4. Is there a blockage in the cleaner base? To clear a blockage, see the instructions on page 6.
5. Are the filters blocked? To clear the filters, see the instructions on page 5.
6. Are the brushes rotating correctly? To check the brushes, see the instructions on page 6.

If there is any doubt call the Hoover Service Office for advice. They may be able to assist you over the telephone. A service charge will be made if the cleaner is examined and found to be in

Working order, has not been assembled in accordance with these instructions or has been used incorrectly.

IMPORTANT: Do not run cleaner over the supply cord as this could damage the supply cord insulation.

IMPORTANT INFORMATION

Hoover Service

Should you require service at any time, please contact your local Hoover Service Office.

Hoover spares and Consumables

Always replace parts with genuine Hoover spares. These are available from your local Hoover dealer or direct from Hoover. When ordering parts always quote your model number.

Quality

Hoover's factories have been independently assessed for quality. Our products are made using a quality system which meets the requirements of ISO 9001

GUARANTEE STATEMENT

The guarantee conditions for this appliance are as defined by our representative in the country in which it is sold. Details regarding these conditions can be obtained from the dealer from whom the appliance was purchased. The bill of sale or receipt must be produced when making any claim under the terms of this guarantee.

Subject to change without notice.

