

BUSH

Instruction manual

WMNBX714W
WMNBFX714W
WMNBX814W
WMNBX914W
WMNBX1016W
WMNBX1214
WMNBX1214W



You'll soon be enjoying your new washing machine.

It all begins here, with your instructions. Don't worry, there's nothing too technical coming up. Just simple, step-by-step guidance to get you up and running quickly. Sound good? Then let's get started.

Help and Guidance

We're here to help you get the most from your washing machine. Should you require any guidance, a simple solution can often be found online at:

www.bush-support.com

If you still require further assistance, call one of our experts on **0345 257 7271**.

Contents

1 Safety information

Safety information 6

2 Getting to know your washing machine

Ready? Let's begin 10

Accessories 12

3 Installing your washing machine

Installation requirements 14

Unpacking 14

Connections (electrical, water, gas) 15

4 Functions

Functions 18

5 Using your washing machine

First use of washing machine 28

Standard and advanced functions/use 29

6 Care and Maintenance

Cleaning 34

Maintenance actions 34

Technical specifications 36

7 Product support

Troubleshooting 42

Help and assistance 43

Declaration of conformance to product standards 44

Disposal 45

Safety information

1





Safety information

Important - Please read these instructions fully before installing or operating

- If the supply cord is damaged, it must be replaced by the manufacturer, its service agent or similarly qualified persons in order to avoid a hazard.
- The new hose-sets supplied with the appliance are to be used and the old hose-sets should not be reused.
- This washing machine is for indoor use only.
- The openings must not be obstructed by a carpet.
- This appliance is not intended for use by persons (including children) with reduced physical, sensory or mental capabilities, or lack of experience and knowledge, unless they have been given supervision or instruction concerning use of the appliance by a person responsible for their safety.
- Pull out its plug from the power socket before cleaning or maintenance.
- Make sure that all pockets are emptied.
- Sharp and rigid items such as a coin, brooch, nail, screw or stone etc. may cause serious damages to this machine.
- Pull out its plug and cut off water supply after the operation.
- Please check whether the water inside the drum has been drained before opening its door. Please do not open the door if there is any water visible.
- Check machine before every operation to ensure pets and children are not in the machine.
- Glass door may be very hot during the operation. Keep children and pets far away from the machine during the operation.
- Take care that power voltage and frequency shall be identical to those required by washing machine.
- Do not use any socket with rated current less than that required by washing machine. Never pull out power plug with wet hand.
- To ensure your safety, the power cord plug must be inserted into an earthed three-pole socket. Check carefully and make sure that your socket is properly and reliably earthed.

If you require any technical guidance or find that your product is not operating as intended, a simple solution can often be found in the **Troubleshooting** section of these instructions.



Safety information

Important - Please read these instructions fully before installing or operating

- Children of less than 3 years should be kept away unless continuously supervised.
- Do not let children play with the machine.
- Packing materials may be dangerous to children. Please keep all packing materials (plastic bags, foams etc) far away from children.
- Washing machine shall not be installed in bath room or very wet rooms as well as in rooms with explosive or caustic gases.
- Make sure that the water and electrical devices are connected by a qualified technician in accordance with the manufacturer's instructions and local safety regulations.
- Before operating this machine, all packages and transport bolts must be removed. Otherwise, the washing machine may be seriously damaged while washing the clothes.
- After unpacking the washing machine, please undertake one wash cycle with no clothes first to clean the drum before using it for your clothes.
- The washing machine with single inlet valve only can be connected to the cold water supply.
- Your washing machine is only for home use and is only designed for textiles suitable for machine washing.
- Flammable and explosive or toxic solvents are forbidden. Gasoline and alcohol etc. Shall not be used as detergents. Shall only select the detergents suitable for machine washing.
It is forbidden to wash carpets.
- Be careful of burning when washing machine drains hot washing water. Never refill the water by hand during washing.
- After the program is completed, please wait for two minutes to open the door.
- Please remember to disconnect water and power supply immediately after the clothes are washed.
- Do not climb up and sit on top cover of the machine.
Do not lean against machine door.
- Please do not close the door with excessive forces. If it is found to be difficult to close the door, please check that the loading is not excessive and the load is distributed evenly.
- The household washing machine isn't intended to be built-in.
- Cautions during Handling Machine
 1. Transport bolts shall be reinstalled to the machine by a qualified person.
 2. The accumulated water shall be drained out of the machine.
 3. Handle the machine carefully.
- Never hold each protruded part on the machine while lifting. Machine door can not be used as the handle during the conveyance.

Getting to know your washing machine

2



Getting to know your washing machine

You'll be up and running in no time

Ready? Let's begin...

Please read these instructions carefully. They contain important information which will help you get the best from your washing machine and ensure safe and correct installation and operation.

If you require any further assistance, our technical experts are happy to help. For full details, refer to the product support section at the end of these instructions.

If you require any technical guidance or find that your product is not operating as intended, a simple solution can often be found in the **Troubleshooting** section of these instructions.

Getting to know your washing machine

You'll be up and running in no time

Component

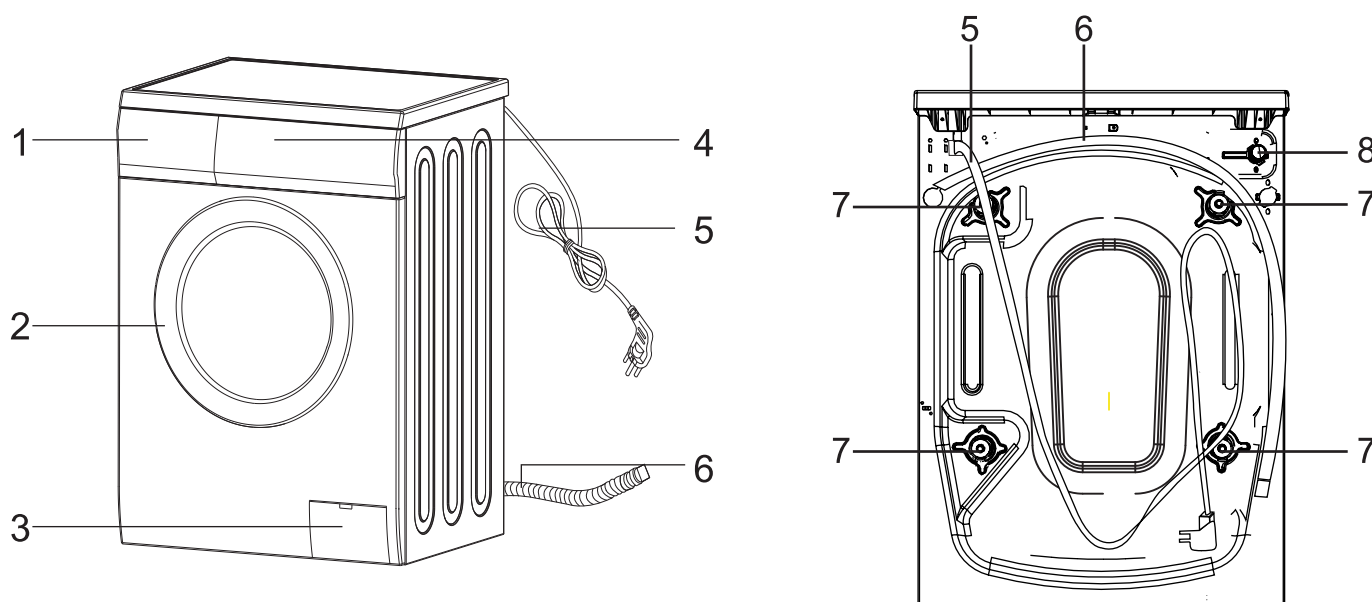

1.Detergent Drawer

2.Door

3.Filter

4.Control Panel

5.Power lead

6.Drain hose

7.Transport bolt x 4

8.Water inlet

Getting to know your washing machine

You'll be up and running in no time

Model	capacity	Spin Speed	Energy class
WMNBX714W	7kg	1400rpm	A+++
WMNBFX714W	7kg	1400rpm	A+++
WMNBX814W	8kg	1400rpm	A+++
WMNBX914W	9kg	1400rpm	A+++
WMNBX1016W	10kg	1600rpm	A+++
WMNBX1214	12kg	1400rpm	A+++ -30%
WMNBX1214W	12kg	1400rpm	A+++ -30%

Accessories

This machine includes below accessories, please install these parts by yourself before operating.

- plastic hole plug x 4
- Inlet hose

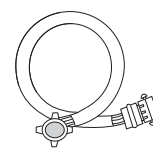
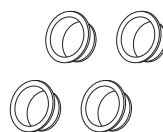

Tools

You may use this tools to help install above parts

- glove
- spanner

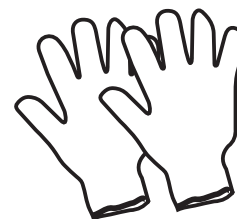
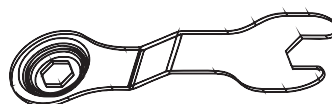

If you require any technical guidance or find that your product is not operating as intended, a simple solution can often be found in the **Troubleshooting** section of these instructions,

Installing your washing machine

3



Installing your washing machine

Bringing it all together

Installation requirements

- In addition to the instructions mentioned here, special regulations of the relevant water companies may apply. If in doubt, have the washing machine connected by a qualified technician.
- The washing machine is heavy - caution when lifting it.
- Do not lift by projecting components (e.g. washing machine door).
- Warning: Frozen hoses may tear/burst. Do not install washing machine in outdoor areas or where there is a risk of frost. Please operate washing machine above 0°C.
- Lay hoses and cables in such a way that there is no risk of tripping over them.

! An additional space (approximately 120mm) is required at the rear of the washing machine. This is to allow enough space for the water hoses.

- Dimension of the machine with door open.

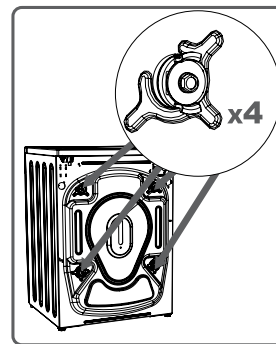
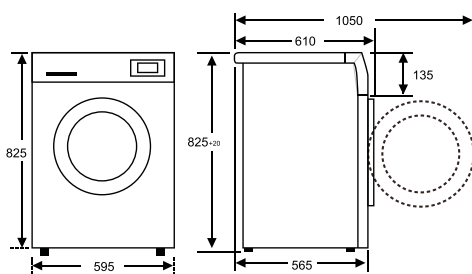

Fig 1

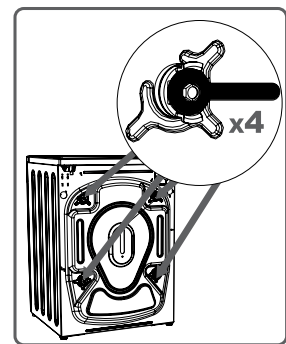

Fig 2

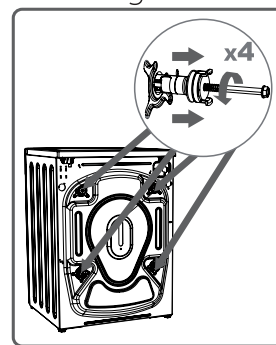

Fig 3

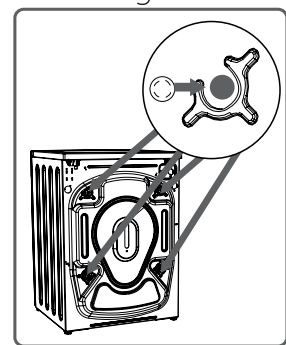

Fig 4

Levelling feet

1: For your machine to work efficiently with minimum vibration it should be settled on flat, nonslippery, firm ground.

2: You can adjust the balance of your machine by changing the positioning of its feet.

3: First, loosen the plastic adjustment nut. (Fig 5)

4: Adjust by rotating the feet upwards or downwards. (Fig 6)

5: After the desired position has been reached, tighten the plastic adjustment nut again by rotating it upwards.

Note: Never put cartons, wooden blocks or similar materials under the machine to balance irregularities in the level of the ground.

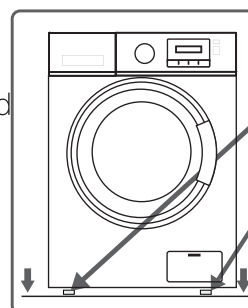

Fig 5

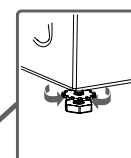
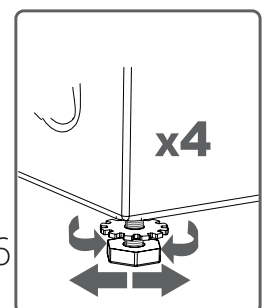

Fig 6



Unpacking

Unpacking your washing machine

Caution: Two people are required to unpack the washing machine, it is recommended that gloves are worn.

Carefully remove all packing materials including the foam base and dispose of correctly.

Note: When opened, water droplets may be visible in the drum etc. this is normal as each appliance is tested before delivery.

Removing the transport bolts

Important: The transport bolts are designed to support the internal components during transit and these MUST be removed before use.

1: Loosen the screws by rotating counterclockwise with a suitable wrench. (Fig 1, 2)

2: Remove the bolts by pulling them. (Fig 3)

3: When the transport bolts have been removed, insert the plastic hole pulgs found in the accessories bag into the holes. (Fig 4)

If you require any technical guidance or find that your product is not operating as intended, a simple solution can often be found in the **Troubleshooting** section of these instructions.

Installing your washing machine

Bringing it all together

Connections

Water inlet hose connections

Important: This washing machine **MUST** only be connected to a cold water supply.

1: Connect the water inlet hose, the angled connection attaches to the water inlet on the back of the washing machine. (Fig 7)

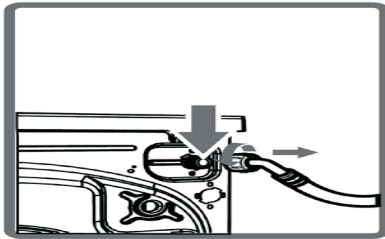

Fig 7

2: The straight connection attaches to the water supply valve. (Fig 8)

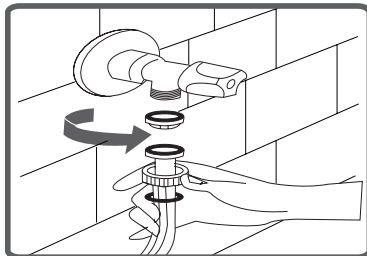

Fig 8

3: Ensure all seals are in place before connecting.

Important: Only tighten the hose connection nut by hand - do not overtighten.

Drain hose connections

Important: The height of the top of the curve in the drain hose **MUST** be between 60 - 100cm from the floor. (Fig 9)

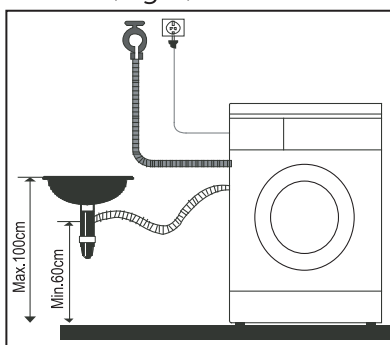

Fig 9

Drain hose can be fitted to the drainer or a wash basin.

Electrical



Any electrical work that is required to install this appliance **MUST** be carried out by a qualified electrician.



Warning: **THIS APPLIANCE MUST BE EARTHED**

Before making any electrical connections, ensure that:

- Electrical safety is only guaranteed when the earth system of your house is in accordance with the related local regulations.
- Do not bend, stretch or pull the supply cable to avoid electric shock.
- Ensure the power socket is suitable for the maximum power of the machine (fuses in the power circuit must be 13 amp).
- The supply voltage should be the same as that indicated in the technical specifications and the appliance rating plate.
- The appliance should be earthed and in compliance with the applicable law.
- When installed, the power socket must be within easy reach.
- If the socket outlets in your home are not suitable for the plug supplied with this unit check with a qualified electrician for replacement.
- To avoid the risk of overloading your plug socket, the use of adapters, multiple connectors or extension cables are not recommended.
- The appliance must be connected to a 220-240 volt 50Hz AC supply by means of a three pin socket, suitably earthed and protected by a 13 amp fuse.
- Should the fuse need to be replaced, a 13 amp fuse approved to BS 1362/A must be used.
- The plug contains a removable fuse cover that must be refitted when the fuse is replaced. If the fuse cover is lost or damaged, the plug must not be used until a replacement cover has been fitted or the plug is replaced.
- A damaged plug should be cut off as close to the plug body as possible, the fuse should be removed and the plug disposed of safely.

Installing your washing machine

Bringing it all together

Plug replacement (UK & Ireland only)

Should you need to replace the plug; the wires in the power cable are coloured in the following way:

Blue - Neutral 'N'

Brown - Live 'L'

Green & Yellow - Earth 'E'

As the colour of the wires in the power cable may not correspond with the coloured markings identifying the terminals in your plug, and proceed as follows (Fig 10):

The green & yellow wire must be connected to the terminal in the plug that is marked with the letter E or by the earth symbol.

The blue wire must be connected to the terminal that is marked with the letter N.

The brown wire must be connected to the terminal that is marked with the letter L.

If power supply cord is damaged, it must be replaced by the manufacturer or its service agent or a similar qualified person in order to avoid a hazard.

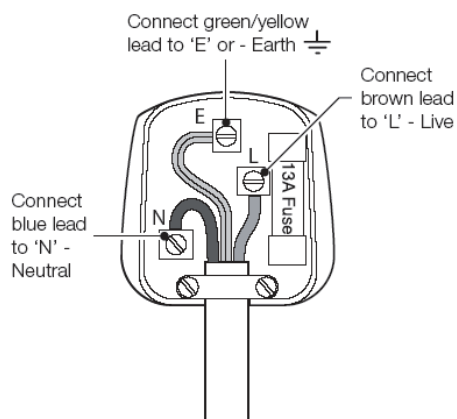

Fig 10

If you require any technical guidance or find that your product is not operating as intended, a simple solution can often be found in the **Troubleshooting** section of these instructions.

Functions 4



Functions

Simple everyday use

Introduction of control panel

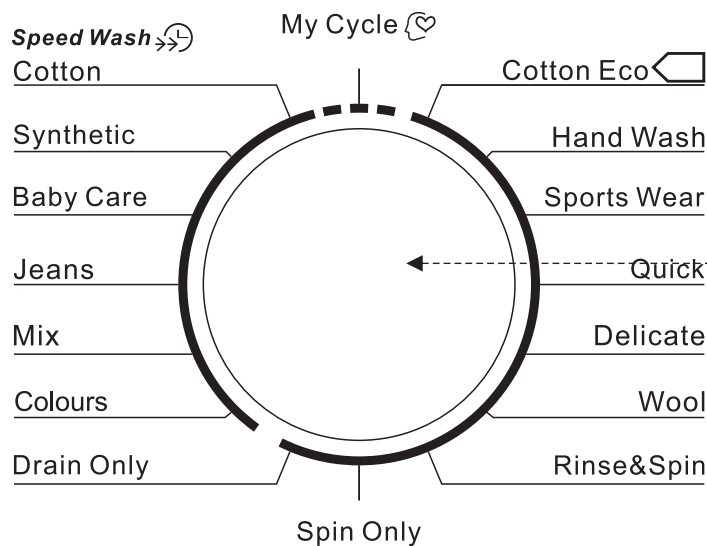

Program selection knob
For you to select different washing program.

Spin Speed Indicator	
Capacity.	Available spin speed (rpm).
7kg & 8kg & 9kg & 12kg	0-600-800-1000-1200-1400
10kg	0-400-800-1200-1400-1600

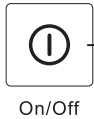
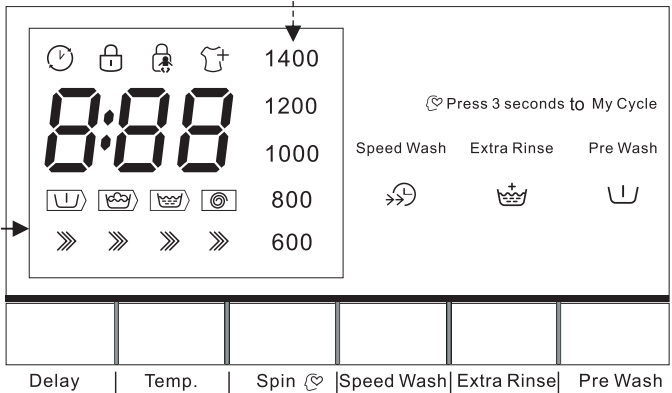

Auxiliary functions setting
Buttons that allow user to set delay time (press button repeatedly to set time delay in 1 hour increments), temperature and speed and so on.

Start/Pause
Press the button to start or pause the wash cycle

On/Off
Press once to turn the washing machine on, press again to turn the washing machine off.

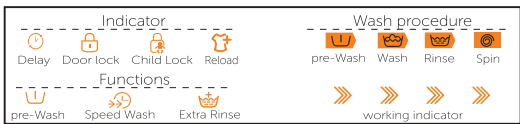

If you require any technical guidance or find that your product is not operating as intended, a simple solution can often be found in the **Troubleshooting** section of these instructions.

Functions

Simple everyday use

Introduction of control panel

Turning the machine on

Plug in your machine. Place the laundry in the machine and add detergent and softener. Press the "on/off" button.

Program selection

First, switch the program knob to select suitable program according to the types of textiles.

Second, select a proper temperature by following the care instructions on the clothes.

Last, select the proper spin speed.

Generally, the higher temperature will consume more energy; the higher spin speed will cause more noise.

PLEASE NOTE: to protect the delicate clothes, the lower spin speed shall be selected.

The main washing procedures depend on the types of the clothes to be washed as follows:

Main program

Depending on the type of textile, the following main programs are available: Each of these main programs comprise of a complete washing process, including washing, rinsing and, if required, spin cycles.

● Cotton

Suitable for textiles made of cotton or linen, for example coats, bed sheets, towels, etc.

● Cotton ECO

This is the most energy efficient programme to clean all kinds of soiled cotton laundry.

● Baby Care

You can select this procedure to wash your baby's clothes. This procedure can make the baby's wear cleaner and make the rinse performance better to help protect the baby's skin.

● My Cycle

You can notice that the a same small icon is beside "Speed" button.

First, choose the favorite program you want; second, select suitable functions (delay function is not available); then press "Spin  " button for three seconds to set "MyCycle". Your selections will be memorized in My Cycle program. If you want to change it to another program, just repeat above procedure. Default "My Cycle" program is "Cotton".

● Synthetic

You can select this procedure to wash the quite delicate clothes. The procedure is shorter compared with that for cottons and the washing movement is quite gentle. It is recommended to wash synthetic articles, for example: shirts, coats, blending. As for curtains and laced textiles, the procedure "Synthetic" shall be selected. While washing the knitting textiles, detergent quantity shall be reduced due to its loose string construction and easily forming bubbles.

● Delicate

You can select this procedure to wash your delicate clothes. Its washing movement is gentler and spin speed is less compared with the procedure "Synthetic". It is recommended for the articles to be washed softly.

● Wool

You can select this procedure to wash the wool textiles labeled with "Machine Wash". Please select the proper washing temperature according to the label on the articles to be washed. Furthermore, the proper detergent shall be selected for wool textiles.

● Colours

You can choose this program for washing brightly coloured clothing.

● Spin Only

Separate spin only procedure. Soap water or rinse water shall be drained out before spinning.

● Quick

This procedure is suitable for washing few and not very dirty clothes quickly.

● Rinse&Spin

The process of rinsing can remove the foam and dirt from the clothes so that the clothes can be cleaned, the followed with spin programme.

● Drain Only

This programme is for drain process only. For example, you want to open the door when the drum is full of water, but no spin process is required.

● Mix

This program is suitable for daily wash. Cotton, synthetic, jeans and children's textiles can all be mixed and washed together with like colours. Do not use this programme for wool and delicate clothes such as silks.

Functions

Simple everyday use

Introduction of control panel

- **Sports Wear**

You can select this procedure to wash the activewear.

- **Jeans**

This program is specially designed for washing jeans.

- **Hand Wash**

As for few light dirty clothes, the default temperature of washing is cold.

Auxiliary function

These functions can be used based on the main program, you can press these functions after you chose the main program.

Note: you can't use these functions after the main program has started.

- **Prewash** 

The indicator of prewash will light up on the display.

The Prewash function can provide an extra wash before the main wash.

- **Speed Wash** 

The function can decrease the washing time.

- **Extra Rinse** 

The laundry will undergo extra rinse once after you select it.

- **Delay** 

Delay function can be set with this button, the delaying time is 0-24 H.

Set the Delay function:

1. Select a programme;
2. Press the Delay button to choose the time;
3. Press Start/Pause to commence the delay operation.

Cancel the Delay function: Press the Delay button until the display will be 0H. It should be pressed before starting the program. If the program has already started, press the On/Off button.

Notes: If there is any break in the power supply while the machine is operating, a special memory stores the selected programme and when the power is restarted, press the Start/Pause button.

- **Spin**

Select spin speed.

- **Temp.**

Choose suitable temperature for the fabric.

- **Reload**

This operation can be executed during the washing procedure. However when the drum of the washing machine is still rolling and there is a large amount of water present in the drum - the door is unable to be opened forcefully.

The following procedure must be followed-

Press **【Start/Pause】** for 3 sec. to reload, and start the clothes adding in the midway function. Please follow the steps as below:

- 1.Wait until the drum stops rotation.
- 2.The door lock is unlocked.
- 3.Close the door when the clothes are loaded and repress the **【Start/Pause】** button.

- **Child Lock**  **(Extra Rinse & Pre Wash)**

This mode allows the unit to be "locked" from additional buttons being pressed. However, On/Off still functions and the machine remembers the child lock feature is active and when powered off and then on again – the machine will continue from the point of switch off. Please note: if power is lost – then the child lock feature will not remain on when power is brought back to the unit.

- **How to set Child Lock**

Press Extra Rinse and Pre Wash together 3 seconds during the running procedure, and the buzzer will beep.

Press the two buttons for 3 seconds together and buzzer will beep to release locking.

Child lock feature will not be cancelled after all procedures are completed.

- **A coustic signals**

This is an additional buzzer function on your appliance.

After starting the machine, press the "Temp.&Spin" button for 3 seconds and you will hear a beep.

To restart the buzzer function, press the "Temp.&Spin" button again for 3 seconds. The setting will be kept until the next reset.

Warning: After deactivating the buzzer function, the sounds will not be activated any more.

- **Bubble Removal Function**

Bubble Check Function: Redundant bubbles will occur when there is excessive detergent, which will affect wash and rinse effects. The procedure will check automatically and one bubble removal procedure will be added automatically to remove bubbles when excessive bubbles are checked.

If you require any technical guidance or find that your product is not operating as intended, a simple solution can often be found in the **Troubleshooting** section of these instructions.

Functions

Simple everyday use

Program Selection Guide -
7kg washing machine(WMNBX714W/WMNBFX714W)

Procedure Description	Max. Load(kg) WMNBX714W WMNBFX714W	Detergent Box			Delay	Speed wash	Extra rinse	Prewash	Max.Water Temp.(°C)	Washing Time (H) WMNBX714W WMNBFX714W	Max.Speed(RPM)
		Case I	Case II	Softener Case							
Cotton	7.0	○	●	○	○	○	○	○	90	2:40	800
Synthetic	3.5	○	●	○	○	○	○	○	60	1:40	800
Baby Care	7.0	○	●	○	○	○	○	○	40	1:20	800
Jeans	7.0	○	●	○	○	○	○	○	90	1:45	800
Mix	7.0	○	●	○	○	○	○	○	90	1:13	800
Colours	3.5	×	●	○	○	○	×	×	30	1:10	1000
Drain Only	—	×	×	×	○	×	×	×	—	0:01	—
Spin Only	7.0	×	×	×	○	×	×	×	—	0:12	1000
Rinse&Spin	7.0	×	×	○	○	×	○	×	—	0:20	1000
Wool	2.0	×	●	○	○	×	○	×	40	1:07	600
Delicate	2.5	×	●	○	○	×	○	×	30	0:50	600
Quick	2.0	×	●	○	○	×	×	×	40	0:15	800
Sports Wear	3.5	○	●	○	○	×	○	○	60	0:45	1000
Hand Wash	2.0	○	●	○	○	×	○	○	30	1:00	1000
Cotton ECO	7.0	×	●	○	○	×	×	×	60	2:53	1400

- Half load for 7.0Kg machine: 3.5Kg.

1) Test wash cycle in compliance with directive 2010/30/EU : Set Cotton ECO with temperature of 60°C

- This cycle is designed for cotton loads with a normal soil level and is the most efficient in terms of both electricity and water consumption; it should be used for garments which can be washed at 60°C. The actual washing temperature may differ from the indicated value.

2) Test wash cycle in compliance with directive 2010/30/EU : Set Cotton ECO with temperature of 40°C

- This cycle is designed for cotton loads with a normal soil level and is the most efficient in terms of both electricity and water consumption; it should be used for garments which can be washed at 40°C. The actual washing temperature may differ from the indicated value.

● Means must ○ Means optional × Means not necessary

Note : Water and power consumption and programme duration may differ from the table shown, subject to changes in water pressure, water hardness and temperature, ambient temperature, type and amount of laundry, selection of auxiliary functions, and fluctuations in the supply voltage.

Functions

Simple everyday use

Program Selection Guide -
8kg washing machine(WMNBX814W)

Procedure Description	Max. Load(kg)	Detergent Box			Delay	Speed wash	Extra rinse	Prewash	Max.Water Temp.(°C)	Washing Time (H)	Max.Speed(RPM)
	WMNBX814W	Case I	Case II	Softener Case						WMNBX814W	1400
Cotton	8.0	○	●	○	○	○	○	○	90	2:40	800
Synthetic	4.0	○	●	○	○	○	○	○	60	1:40	800
Baby Care	8.0	○	●	○	○	○	○	○	40	1:20	800
Jeans	8.0	○	●	○	○	○	○	○	90	1:45	800
Mix	8.0	○	●	○	○	○	○	○	90	1:13	800
Colours	4.0	×	●	○	○	○	○	×	30	1:10	1000
Drain Only	—	×	×	×	○	×	×	×	—	0:01	—
Spin Only	8.0	×	×	×	○	×	×	×	—	0:12	1000
Rinse&Spin	8.0	×	×	○	○	×	○	×	—	0:20	1000
Wool	2.0	×	●	○	○	×	○	×	40	1:07	600
Delicate	2.5	×	●	○	○	×	○	×	30	0:50	600
Quick	2.0	×	●	○	○	×	×	×	40	0:15	800
Sports Wear	4.0	○	●	○	○	×	○	○	60	0:45	1000
Hand Wash	2.0	○	●	○	○	×	○	○	30	1:00	1000
Cotton ECO	8.0	×	●	○	○	×	×	×	60	2:53	1400

- Half load for 8.0Kg machine: 4.0Kg.

1) Test wash cycle in compliance with directive 2010/30/EU : Set Cotton ECO with temperature of 60°C

- This cycle is designed for cotton loads with a normal soil level and is the most efficient in terms of both electricity and water consumption; it should be used for garments which can be washed at 60°C. The actual washing temperature may differ from the indicated value.

2) Test wash cycle in compliance with directive 2010/30/EU : Set Cotton ECO with temperature of 40°C

- This cycle is designed for cotton loads with a normal soil level and is the most efficient in terms of both electricity and water consumption; it should be used for garments which can be washed at 40°C. The actual washing temperature may differ from the indicated value.

● Means must ○ Means optional × Means not necessary

Note : Water and power consumption and programme duration may differ from the table shown, subject to changes in water pressure, water hardness and temperature, ambient temperature, type and amount of laundry, selection of auxiliary functions, and fluctuations in the supply voltage.

If you require any technical guidance or find that your product is not operating as intended, a simple solution can often be found in the **Troubleshooting** section of these instructions.

Functions

Simple everyday use

Program Selection Guide -
9kg washing machine(WMNBX914W)

Procedure Description	Max. Load(kg) WMNBX914W	Detergent Box			Delay	Speed wash	Extra rinse	Prewash	Max.Water Temp.(°C)	Washing Time (H) WMNBX914W	Max.Speed(RPM) 1400
		Case I	Case II	Softener Case							
Cotton	9.0	○	●	○	○	○	○	○	90	2:40	800
Synthetic	4.5	○	●	○	○	○	○	○	60	1:40	800
Baby Care	9.0	○	●	○	○	○	○	○	40	1:20	800
Jeans	9.0	○	●	○	○	○	○	○	90	1:45	800
Mix	9.0	○	●	○	○	○	○	○	90	1:13	800
Colours	4.5	×	●	○	○	○	○	×	30	1:10	1000
Drain Only	—	×	×	×	○	×	×	×	—	0:01	—
Spin Only	9.0	×	×	×	○	×	×	×	—	0:12	1000
Rinse&Spin	9.0	×	×	○	○	×	○	×	—	0:20	1000
Wool	2.0	×	●	○	○	×	○	×	40	1:07	600
Delicate	2.5	×	●	○	○	×	○	×	30	0:50	600
Quick	2.0	×	●	○	○	×	×	×	40	0:15	800
Sports Wear	4.5	○	●	○	○	×	○	○	60	0:45	1000
Hand Wash	2.0	○	●	○	○	×	○	○	30	1:00	1000
Cotton ECO	9.0	×	●	○	○	×	×	×	60	3:42	1400

- Half load for 9.0Kg machine: 4.5Kg.

1) Test wash cycle in compliance with directive 2010/30/EU : Set Cotton ECO with temperature of 60°C

- This cycle is designed for cotton loads with a normal soil level and is the most efficient in terms of both electricity and water consumption; it should be used for garments which can be washed at 60°C. The actual washing temperature may differ from the indicated value.

2) Test wash cycle in compliance with directive 2010/30/EU : Set Cotton ECO with temperature of 40°C

- This cycle is designed for cotton loads with a normal soil level and is the most efficient in terms of both electricity and water consumption; it should be used for garments which can be washed at 40°C. The actual washing temperature may differ from the indicated value.

● Means must ○ Means optional × Means not necessary

Note : Water and power consumption and programme duration may differ from the table shown, subject to changes in water pressure, water hardness and temperature, ambient temperature, type and amount of laundry, selection of auxiliary functions, and fluctuations in the supply voltage.

Functions

Simple everyday use

Program Selection Guide -
10kg washing machine(WMNBX1016W)

Procedure Description	Max. Load(kg) WMNBX1016W	Detergent Box			Delay	Speed wash	Extra rinse	Prewash	Max.Water Temp.(°C)	Washing Time (H) WMNBX1016W	Max.Speed(RPM) 1600
		Case I	Case II	Softener Case							
Cotton	10.0	○	●	○	○	○	○	○	90	2:40	800
Synthetic	5.0	○	●	○	○	○	○	○	60	1:40	800
Baby Care	10.0	○	●	○	○	○	○	○	40	1:20	800
Jeans	10.0	○	●	○	○	○	○	○	90	1:45	800
Mix	10.0	○	●	○	○	○	○	○	90	1:13	800
Colours	5.0	×	●	○	○	○	○	×	30	1:10	1000
Drain Only	—	×	×	×	○	×	×	×	—	0:01	—
Spin Only	10.0	×	×	×	○	×	×	×	—	0:12	1000
Rinse&Spin	10.0	×	×	○	○	×	○	×	—	0:20	1200
Wool	2.0	×	●	○	○	×	○	×	40	1:17	600
Delicate	2.5	×	●	○	○	×	○	×	30	0:50	600
Quick	2.0	×	●	○	○	×	×	×	40	0:15	800
Sports Wear	5.0	○	●	○	○	×	○	○	60	0:45	1200
Hand Wash	2.0	○	●	○	○	×	○	○	30	1:00	1000
Cotton ECO	10.0	×	●	○	○	×	×	×	60	3:59	1600

- Half load for 10.0Kg machine: 5.0Kg.

1) Test wash cycle in compliance with directive 2010/30/EU : Set Cotton ECO with temperature of 60°C

- This cycle is designed for cotton loads with a normal soil level and is the most efficient in terms of both electricity and water consumption; it should be used for garments which can be washed at 60°C. The actual washing temperature may differ from the indicated value.

2) Test wash cycle in compliance with directive 2010/30/EU : Set Cotton ECO with temperature of 40°C

- This cycle is designed for cotton loads with a normal soil level and is the most efficient in terms of both electricity and water consumption; it should be used for garments which can be washed at 40°C. The actual washing temperature may differ from the indicated value.

● Means must ○ Means optional × Means not necessary

Note : Water and power consumption and programme duration may differ from the table shown, subject to changes in water pressure, water hardness and temperature, ambient temperature, type and amount of laundry, selection of auxiliary functions, and fluctuations in the supply voltage.

If you require any technical guidance or find that your product is not operating as intended, a simple solution can often be found in the **Troubleshooting** section of these instructions.

Functions

Simple everyday use

Program Selection Guide -
12kg washing machine(WMNBX1214/WMNBX1214W)

Procedure Description	Max. Load(kg) WMNBX1214 WMNBX1214W	Detergent Box			Delay	Speed wash	Extra rinse	Prewash	Max.Water Temp.(°C)	Washing Time (H) WMNBX1214 WMNBX1214W	Max.Speed(RPM) 1400
		Case I	Case II	Softener Case							
Cotton	12.0	○	●	○	○	○	○	○	90	2:40	800
Synthetic	6.0	○	●	○	○	○	○	○	60	1:40	800
Baby Care	12.0	○	●	○	○	○	○	○	40	1:20	800
Jeans	12.0	○	●	○	○	○	○	○	90	1:45	800
Mix	12.0	○	●	○	○	○	○	○	90	1:13	800
Colours	6.0	×	●	○	○	○	○	×	30	1:10	1000
Drain Only	—	×	×	×	○	×	×	×	—	0:01	—
Spin Only	12.0	×	×	×	○	×	×	×	—	0:12	1000
Rinse&Spin	6.0	×	×	○	○	×	○	×	—	0:20	1000
Wool	2.0	×	●	○	○	×	○	×	40	1:17	600
Delicate	2.5	×	●	○	○	×	○	×	30	0:50	600
Quick	2.0	×	●	○	○	×	×	×	40	0:15	800
Sports Wear	6.0	○	●	○	○	×	○	○	60	0:45	1000
Hand Wash	2.0	○	●	○	○	×	○	○	30	1:00	1000
Cotton ECO	12.0	×	●	○	○	×	×	×	60	4:03	1400

- Half load for 12.0Kg machine: 6.0Kg.

1) Test wash cycle in compliance with directive 2010/30/EU : Set Cotton ECO with temperature of 60°C

- This cycle is designed for cotton loads with a normal soil level and is the most efficient in terms of both electricity and water consumption; it should be used for garments which can be washed at 60°C. The actual washing temperature may differ from the indicated value.

2) Test wash cycle in compliance with directive 2010/30/EU : Set Cotton ECO with temperature of 40°C

- This cycle is designed for cotton loads with a normal soil level and is the most efficient in terms of both electricity and water consumption; it should be used for garments which can be washed at 40°C. The actual washing temperature may differ from the indicated value.

● Means must ○ Means optional × Means not necessary

Note : Water and power consumption and programme duration may differ from the table shown, subject to changes in water pressure, water hardness and temperature, ambient temperature, type and amount of laundry, selection of auxiliary functions, and fluctuations in the supply voltage.

Using your washing machine

5



Using your washing machine

Getting the most from your appliance

Organising Laundry

- Read the washing label on each garment to help you sort your washing into different loads.
- Sort the laundry by colour, type of fabric and by how soiled it is. This will help you choose the correct programme and temperature for each wash.

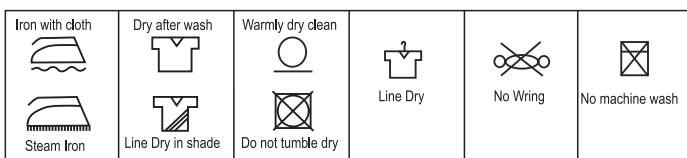
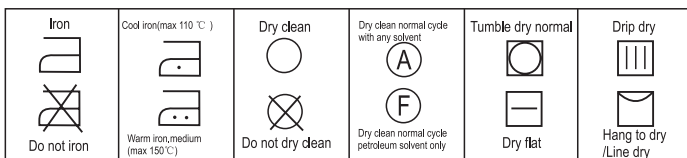
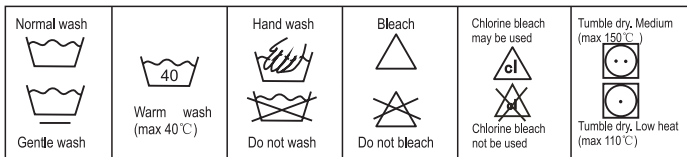

- Do not exceed the maximum load! See the programme selection table for the maximum load for the programme you require.

Articles / clothes	Approx. weight(g)
Cotton quilt covers (single/double)	900/1500
Bed sheets (single/double)	600/900
Work clothes	1120
Large tablecloths	700
Small tablecloths	350
Tea napkins	100
Bath towels	700
Hand towels	300
Blouses	150
Cotton shirts	300
shirts	180
cotton dresses	500
Jeans	800
Jacket	800
Handkerchiefs	100
T-shirts	150
Shorts	70
Socks	50

Preparing Laundry

- Treat stains before washing.
- Some items should be put into a cleaning net before going into the washing machine. i.e. bras with metal wires, tights and lace clothing to prevent damage.
- Check that pockets do not contain any objects which may damage your clothes and the washing machine.
- Tie up any loose strings on laundry, close zippers and reverse clothing with zips inside out.
- To prevent any large, heavy objects (e.g., buckles, large buttons, etc.) from hitting the glass door, turn your clothing inside out, or remove the heavy objects. These could damage your laundry or the washing machine.
- Remove any surplus hair, animal fur, sand, and other materials with a brush before washing.
- If clothes have raised fabric turn them inside out.
- Clothes that are not colour fast should be washed separately.
- Insert your clothes into the washing machine.
- Close the washing machine door. Ensure that you do not trap any items of clothing between the loading door and the rubber seal.

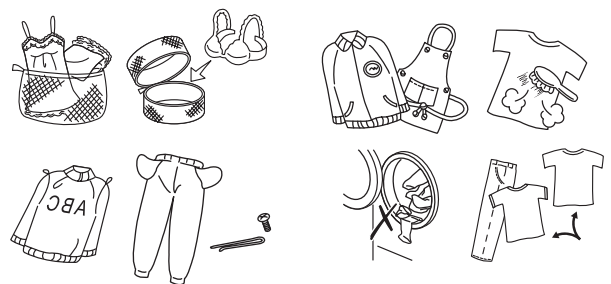

If you require any technical guidance or find that your product is not operating as intended, a simple solution can often be found in the **Troubleshooting** section of these instructions.

Using your washing machine

Getting the most from your appliance

Adding Detergent and Softener

- Add detergent into the appropriate dispenser.
- Apply softener before you start washing.
- Apply detergent and softener according to the washing amount, the soiling level, the water hardness in your area and the manufacturer's instructions of these products.



Dilute viscous fabric softener and fabric conditioner with water. Prevent blockage of the overflow. Maximum level is 40ml.

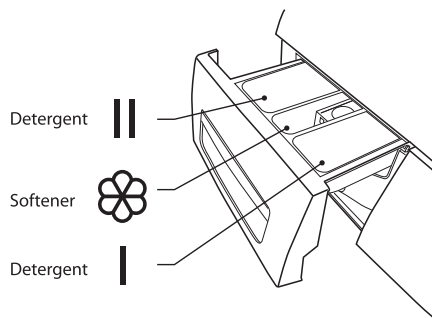

- Do not use the washing machine when the detergent drawer is removed. It may cause a water leak or it may not work normally.
- If you forget to add detergent, you can drain the washing machine by running a drain only programme. Then you can add detergent and start the programme again.
- Detergent only reaches the drum when water flushes through the detergent drawer.
- To prevent powder detergent staying in the drawer, dry the inside of the drawer with a cloth. Make sure the powder isn't lumpy when you add it into the drawer.
- If the rinse cycle isn't removing all the detergent from your wash, use less detergent.
- Softener should not exceed the MAX level in the compartment.

Wash out unused softener with a splash of water or a damp cloth after the programme has finished.

Before First Use

- Prior to the first use of the appliance, it is recommended to run a wash programme without clothes. A small amount of washing detergent should be used.

Wash Setting

Standard Washing

1. Pull the door handle and put the laundry in the drum. (Refer to Preparation to sort your laundry before it goes into the drum.) Make sure no washing gets caught in the door.
2. Close the door and press the On/Off button.
3. Turn the Programme selection dial to select your wash programme.
4. Select the temperature if desired.
5. Add detergent into the detergent drawer. The quantity of detergent will depend on the amount of laundry, the degree of soiling and the water hardness. Use the amount of detergent suggested on the packaging.
6. Press the Start/Pause button to start the washing.
7. The washing machine will sound when the programme is complete.

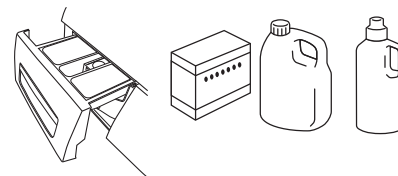

If the door is locked and you switched the washing machine off and then on - or if there's a power cut - it will stay locked for 1 minute.

Using your washing machine

Getting the most from your appliance

Removing Washing (Once programme is finished)

 Door remains locked for 1 minute after wash stopped.

- Open the washing machine door and remove your washing.
- Remove any foreign objects to avoid risk of rusting.
- Leave the door and detergent drawer open so that residual water can evaporate.

1.Changing the selection after the program started?

If you need to change a setting after the wash has started, press on/off, then on/off again, Re-select the program, spin speed and optional functions, and then press the Start / Pause button. (Ensure the Child Lock is off, otherwise the original program will continue.)

2.Adding/removing laundry in pause mode?

Press Start/Pause button for 3 seconds, wait until the drum stops rotating. When the door lock is unlocked, you can add/remove laundry and repress Start/Pause button after close the door.

3.Door lock

The icon lock will light up automatically once the program starts. The door lock icon will fade out as soon as the program ends and the door will be allowed to open automatically.

4.End of program

It will sound for 5 seconds after the end of program and the display will indicate "end" icon.

If you require any technical guidance or find that your product is not operating as intended, a simple solution can often be found in the **Troubleshooting** section of these instructions.

Using your washing machine

Getting the most from your appliance

Quick start

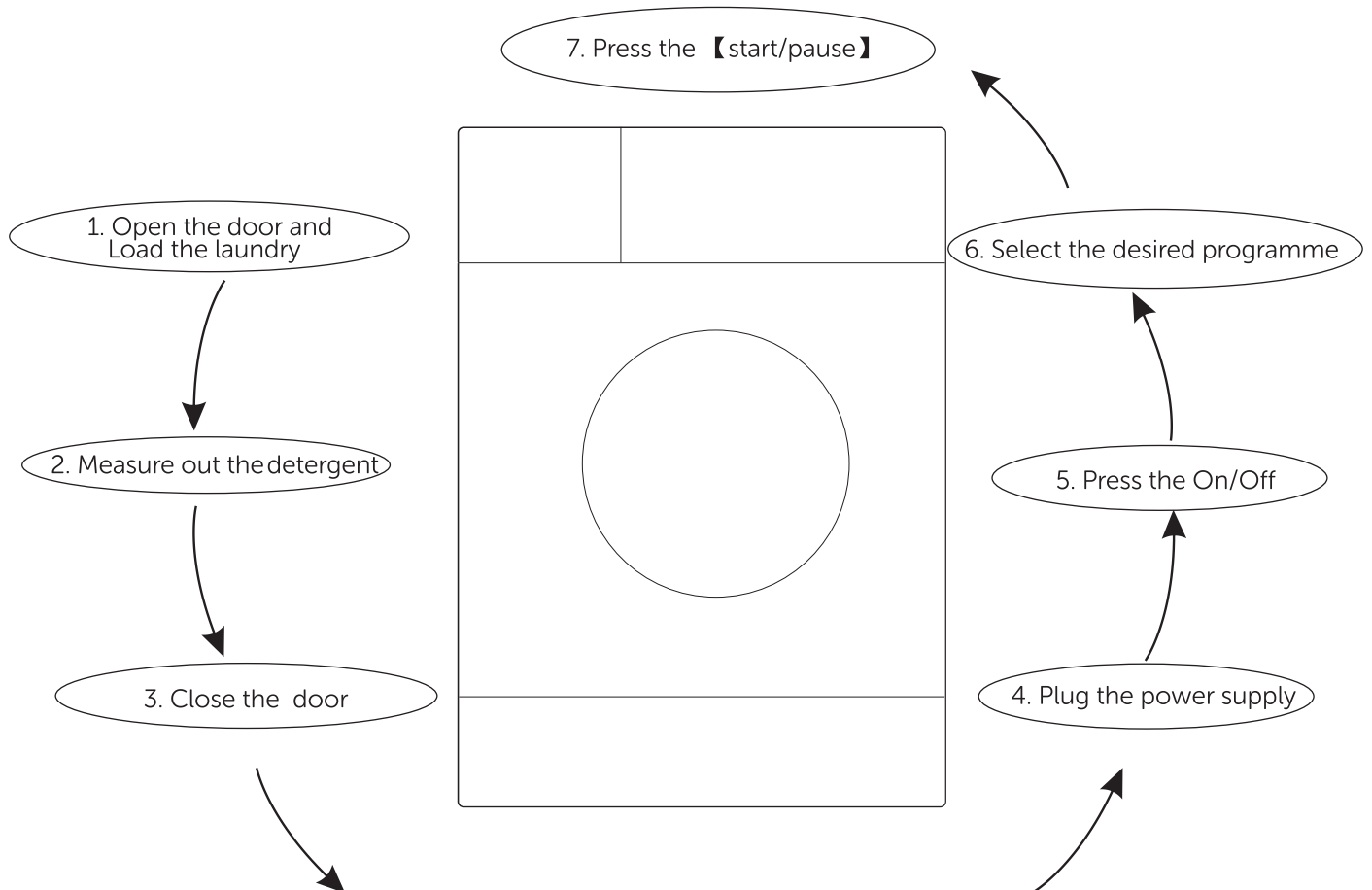

After washing :

- 1.The washing machine will sound several times for 5 seconds.
- 2.It is recommend to close the water tap and pull out the power plug,;

Care and maintenance

6



Care and maintenance

Looking after your appliance

Before your maintenance starts, disconnect the power, remove the plug from the supply and close the tap.



- Do not use solvents to clean the washing machine, as this may damage the unit and could generate toxic gases.
- Do not use the detergents containing PCMX to clean the washing machine.

Cleaning and Maintenance of Washing Machine Cabinet

- Correct maintenance on the washing machine can extend its working life. The surface can be cleaned with diluted nonabrasive neutral detergents when necessary. If there is any water overflow, use a wet cloth to wipe it off immediately.
- No sharp items are allowed to strike the cabinet.

Notes: Do not use formic acid and its diluted solvents or equivalent.

Clean Internal Drum

- Rust left inside the drum by metal articles shall be removed immediately with chlorine-free detergents.
- Never use steel wool.

Defrost a Frozen Washing Machine

When the temperature drops below zero and your washing machine gets frozen, you may:

1. Disconnect the power supply for the washing machine.
2. Wash the tap with warm water to loosen inlet pipe.
3. Take down inlet pipe and immerse it in warm water.
4. Pour warm water into washing drum and wait for 10 minutes.
5. Reconnect inlet pipe to the tap and check whether inlet and outlet are working normally.

Notes: when the washing machine is reused, make sure the ambient temperature is above 0 °C

Anti-freeze

If your washing machine is located in the room where it can get frozen easily, please drain the remaining water inside drain pipe and inlet pipe thoroughly.

Remove the remaining water in inlet pipe:

1. Close the tap.
2. Screw off the inlet pipe from tap and put its end into a container.
3. Start up any procedure except single Wash or Drain procedure. Water will be drained out of inlet pipe if any for about 40 seconds.
4. Reconnect the inlet pipe to tap. Remove the remaining water in drain pump (Fig 11).

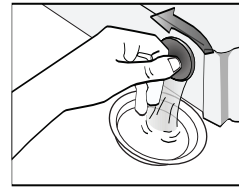

Fig 11

Clean detergent drawer and grooves

1. Press down the arrow location on softener cover inside the drawer.
2. Lift the clip up and take out softener cover and wash all grooves with water.
3. Restore the softener cover and push the drawer into position.

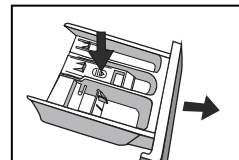

Fig 12

Clean inlet filter

Inlet filter must be cleaned if there is insufficient water when the tap is opened.

Clean the tap filter:

1. Close the tap.
2. Select any procedure except "Wash" or "Drain" procedure.
3. Press the button "Start/Pause" and keep the procedure running for about 40 seconds.
4. Remove the inlet pipe from the tap.
5. Use water to wash the filter.
6. Reconnect the inlet pipe. Washing the filter in washing machine:
 1. Screw off the inlet pipe from the backside of the machine.
 2. Pull out the filter with long nose pliers and reinstall it back after being washed.
 3. Reconnect the inlet pipe.
 4. Open the tap and make sure there is no water leakage.
 5. Close the tap.

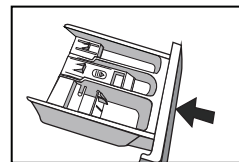

Fig 13

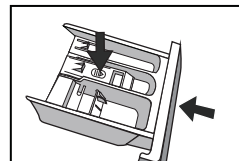

Fig 14



Fig 15

Care and maintenance

Looking after your appliance

Notes: Generally, the tap filter is washed first and then the filter in washing machine will be washed.

If only the filter in washing machine is washed, then the steps 1~3 in cleaning the tap filter shall be repeated (Fig16, 17).

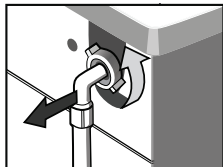

Fig 16

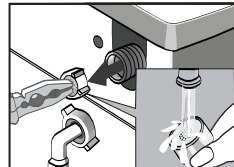

Fig 17



Pull out the power plug to avoid electrical shock before washing.

After using the washing machine, remove all the clothes and close the door tightly.

Remove foreign matters

Drain Pump Filter:

Drain pump filter can filter the yarns and small foreign matters from the washings.

Clean the filter periodically to ensure the normal operation of washing machine.

According to the soil level within the cycles and the frequency of the cycles, you have to inspect and clean the filter regularly.

The pump should be inspected if the machine does not empty and/or spin; The machine makes an unusual noise during draining due to objects such as safety pins, coins etc. blocking the pump.

Clean the pump filter :

1.After the power is disconnected, use hand to open the filter cover(Fig 18).

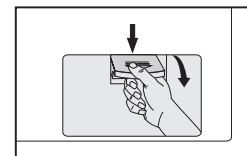

Fig 18

2.Turn the filter down as shown with the figure and take out sundries matters (Fig 19).

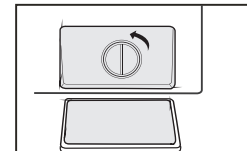

Fig 19

3.Reinstall each part after sundries matters are removed (Fig 20).

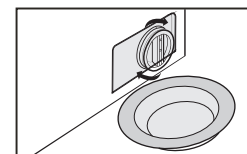

Fig 20

Warning!

When the appliance is in use and depending on the programme selected there can be hot water in the pump. Never remove the filter during a wash cycle, always wait until the appliance has finished the cycle, and is empty. When replacing the filter, ensure it is securely retightened.

Care and maintenance

Looking after your appliance

Technical specification

Brand	BUSH
Type/Description	WMNBX714W , WMNBFX714W
Capacity	7kg
Spin Speed	1400 rpm
Energy efficiency class	A ⁺⁺⁺
Annual energy consumption	175 kWh/annum
Power consumption of off-mode	0.5W
Annual water consumption	10000L/annum
Spin-drying efficiency class	B
Standard washing cycle	Cotton ECO
Energy consumption of the standard 60°C at full load	0.93 kwh/cycle
Energy consumption of the standard 60°C at partial load	0.80 kwh/cycle
Energy consumption of the standard 40°C at partial load	0.51 kwh/cycle
Programme duration of standard 60°C at full load	179 min
Programme duration of standard 60°C at partial load	179 min
Programme duration of standard 40°C at partial load	179 min
Water consumption of the standard 60°C at full load	50L/cycle
Water consumption of standard 60°C at partial load	42L/cycle
Water consumption of the standard 40°C at partial load	42L/cycle
Remaining moisture content of the standard 60°C at full load	51%
Remaining moisture content of the standard 60°C at partial load	54%
Remaining moisture content of the standard 40°C at partial load	54%
Noise level of washing	59dB (A)
Noise level of spinning	78dB (A)
Mounting	Free standing
Height	850 mm
Width	595 mm
Depth	495 mm
Power consumption	2050W
Rate voltage/frequency	220-240V~/50Hz
Water pressure	0.05-1 MPa

If you require any technical guidance or find that your product is not operating as intended, a simple solution can often be found in the **Troubleshooting** section of these instructions.

Care and maintenance

Looking after your appliance

Technical specification

Brand	BUSH
Type/Description	WMNBX814W
Capacity	8kg
Spin Speed	1400 rpm
Energy efficiency class	A ⁺⁺⁺
Annual energy consumption	196 kWh/annum
Power consumption of off-mode	0.5W
Annual water consumption	11000L/annum
Spin-drying efficiency class	B
Standard washing cycle	Cotton ECO
Energy consumption of the standard 60°C at full load	1.05 kwh/cycle
Energy consumption of the standard 60°C at partial load	0.84 kwh/cycle
Energy consumption of the standard 40°C at partial load	0.63 kwh/cycle
Programme duration of standard 60°C at full load	179 min
Programme duration of standard 60°C at partial load	179 min
Programme duration of standard 40°C at partial load	179 min
Water consumption of the standard 60°C at full load	55L/cycle
Water consumption of standard 60°C at partial load	45L/cycle
Water consumption of the standard 40°C at partial load	45L/cycle
Remaining moisture content of the standard 60°C at full load	51%
Remaining moisture content of the standard 60°C at partial load	54%
Remaining moisture content of the standard 40°C at partial load	54%
Noise level of washing	59dB (A)
Noise level of spinning	78dB (A)
Mounting	Free standing
Height	850 mm
Width	595 mm
Depth	565 mm
Power consumption	2000W
Rate voltage/frequency	220-240V~/50Hz
Water pressure	0.05-1 MPa

or online at www.bush-support.com If you still require further assistance, call one of our experts on 0345 257 7271.

Care and maintenance

Looking after your appliance

Technical specification

Brand	BUSH
Type/Description	WMNBX914W
Capacity	9kg
Spin Speed	1400 rpm
Energy efficiency class	A ⁺⁺⁺
Annual energy consumption	218 kWh/annum
Power consumption of off-mode	0.5W
Annual water consumption	11800L/annum
Spin-drying efficiency class	B
Standard washing cycle	Cotton Eco
Energy consumption of the standard 60°C at full load	1.09 kWh/cycle
Energy consumption of the standard 60°C at partial load	0.98 kWh/cycle
Energy consumption of the standard 40°C at partial load	0.85 kWh/cycle
Programme duration of standard 60°C at full load	220 min
Programme duration of standard 60°C at partial load	220 min
Programme duration of standard 40°C at partial load	210 min
Water consumption of the standard 60°C at full load	56L/cycle
Water consumption of standard 60°C at partial load	50L/cycle
Water consumption of the standard 40°C at partial load	50L/cycle
Remaining moisture content of the standard 60°C at full load	50%
Remaining moisture content of the standard 60°C at partial load	55%
Remaining moisture content of the standard 40°C at partial load	55%
Noise level of washing	54dB (A)
Noise level of spinning	76dB (A)
Mounting	Free standing
Height	850 mm
Width	595 mm
Depth	565 mm
Power consumption	2000W
Rate voltage/frequency	220-240V~/50Hz
Water pressure	0.05-1 MPa

If you require any technical guidance or find that your product is not operating as intended, a simple solution can often be found in the **Troubleshooting** section of these instructions.

Care and maintenance

Looking after your appliance

Technical specification

Brand	BUSH
Type/Description	WMNBX1016W
Capacity	10kg
Spin Speed	1600 rpm
Energy efficiency class	A ⁺⁺⁺
Annual energy consumption	167 kWh/annum
Power consumption of off-mode	0.5W
Annual water consumption	13000L/annum
Spin-drying efficiency class	B
Standard washing cycle	Cotton ECO
Energy consumption of the standard 60°C at full load	0.77 kwh/cycle
Energy consumption of the standard 60°C at partial load	0.77 kwh/cycle
Energy consumption of the standard 40°C at partial load	0.88 kwh/cycle
Programme duration of standard 60°C at full load	239 min
Programme duration of standard 60°C at partial load	239 min
Programme duration of standard 40°C at partial load	233 min
Water consumption of the standard 60°C at full load	60L/cycle
Water consumption of standard 60°C at partial load	58L/cycle
Water consumption of the standard 40°C at partial load	58L/cycle
Remaining moisture content of the standard 60°C at full load	42%
Remaining moisture content of the standard 60°C at partial load	45%
Remaining moisture content of the standard 40°C at partial load	45%
Noise level of washing	56dB (A)
Noise level of spinning	78dB (A)
Mounting	Free standing
Height	850 mm
Width	595 mm
Depth	565 mm
Power consumption	2000W
Rate voltage/frequency	220-240V~/50Hz
Water pressure	0.05-1 MPa

or online at www.bush-support.com If you still require further assistance, call one of our experts on 0345 257 7271.

Care and maintenance

Looking after your appliance

Technical specification

Brand	BUSH
Type/Description	WMNBX1214 , WMNBX1214W
Capacity	12kg
Spin Speed	1400 rpm
Energy efficiency class	A ⁺⁺⁺ -30%
Annual energy consumption	197 kWh/annum
Power consumption of off-mode	0.5W
Annual water consumption	14000L/annum
Spin-drying efficiency class	B
Standard washing cycle	Cotton ECO
Energy consumption of the standard 60°C at full load	0.90 kwh/cycle
Energy consumption of the standard 60°C at partial load	0.90 kwh/cycle
Energy consumption of the standard 40°C at partial load	0.82 kwh/cycle
Programme duration of standard 60°C at full load	243 min
Programme duration of standard 60°C at partial load	243 min
Programme duration of standard 40°C at partial load	239 min
Water consumption of the standard 60°C at full load	64L/cycle
Water consumption of standard 60°C at partial load	62L/cycle
Water consumption of the standard 40°C at partial load	62L/cycle
Remaining moisture content of the standard 60°C at full load	50%
Remaining moisture content of the standard 60°C at partial load	55%
Remaining moisture content of the standard 40°C at partial load	55%
Noise level of washing	59dB (A)
Noise level of spinning	76dB (A)
Mounting	Free standing
Height	850 mm
Width	595 mm
Depth	565 mm
Power consumption	2000W
Rate voltage/frequency	220-240V~/50Hz
Water pressure	0.05-1 MPa

If you require any technical guidance or find that your product is not operating as intended, a simple solution can often be found in the **Troubleshooting** section of these instructions.

Product support

7



Product support

Help is always at hand

Troubleshooting

1. Washing Machine does not operate?

Check if the door is closed tightly, power plug is inserted well and then press start/pause button.

2. Washing Machine does not receive water?

Check if the water tap is opened and clean the filters of water inlet hose.

3. Washing Machine is not draining water?

Check the drain hose and clean pump filter.

4. Washing Machine is vibrating?

Check if the feet are adjusted well and make sure transportation screws are removed.

5. The washing result is poor?

Select suitable program and use more detergent.

6. No water is seen in the drum during washing?

No failure. The water is in the lower part of the drum.

7. There are residues of detergent on the clothes?

Some detergents contain ingredients which are not soluble in water and which may form white stains on your clothes. Please adjust your machine, carry out an additional rinse, or eliminate the stains after drying, with a brush.

8. There are grey stains on the clothes?

These stains may be caused by oil, cream or ointment. In the next washing operation, use the maximum detergent amount declared by the detergent producer.

If you require any technical guidance or find that your product is not operating as intended, a simple solution can often be found in the **Troubleshooting** section of these instructions.

Product support

Help is always at hand

Help and assistance

If you require any technical guidance or find that your <washing machine> is not operating as intended, a simple solution can often be found in the **Troubleshooting** section of these instructions or online at

www.argos-support.co.uk

If you still require further assistance, call one of our experts on **0345 257 7271*** To help give us give you a fast and efficient service please have the following information ready:

Model Ref.	<input type="text"/>	You can find these on the rating plate - a small information panel (usually a sticker or metal plate) on the rear of your appliance
Serial number	<input type="text"/>	
Date of purchase	<input type="text"/>	This will be shown on your receipt

Local call rates applies*

Lines open 8am-7pm Monday to Saturday and 10am-4pm Sunday.

*Calls to Argos enquiry lines may attract a charge and set up fee from residential lines depending on your call plan/tarif. Mobile and other providers costs may vary, see www.bt.com/pricing for details.

For Security and training purposes, telephone calls to and from customer service centres maybe recorded and monitored. Calls from Republic of Ireland will attract international call charges.

or online at www.bush-support.com If you still require further assistance, call one of our experts on **0345 257 7271**.

Product support

Help is always at hand



This appliance complies with the following EEC directives:
2014/35/EU low voltage directive
2014/30/EMC directive
2009/125/EC EU Directive

Notes on disposal:



This marking indicates that this product should not be disposed with other household wastes throughout the EU. To prevent possible harm to the environment or human health from uncontrolled waste

disposal, recycle it responsibly to promote the sustainable reuse of material resources. To return your used device, please use the collection systems or contact the retailer where the product was purchased. They may return and may take this product for environmental safe recycling.

If you require any technical guidance or find that your product is not operating as intended, a simple solution can often be found in the **Troubleshooting** section of these instructions.

Product support

Help is always at hand

BUSH

Call us now and activate your 12 month guarantee

Thank you for choosing Bush. Your new product is guaranteed against faults and breakdowns for 12 months. Don't forget to register it with us today so we can provide you with our best possible after-sales service and useful updates.

www.bushregistration.co.uk

FREEPHONE*

0800 597 8548

Lines are open 8am - 8pm, 365 days a year. *Calls may be recorded and monitored.

Your Bush Guarantee

This product is guaranteed for twelve months from the date of original purchase. Any defect that arises due to faulty materials or workmanship will be repaired free of charge (or if applicable the product will be replaced or the purchase price refunded) where possible during this period by the dealer from who your purchased the unit.

The guarantee is subject to the following provisions:

- The guarantee does not cover accidental damage, misuse, cabinet parts, knobs or consumable items.
- The product must be correctly installed and operated in accordance with the instructions contained in the manual.
- It must be used solely for domestic purposes. The guarantee will be rendered invalid if the product is re-sold or has been damaged by inexpert repair.
- Specifications are subject to change without notice.
- Bush disclaim any liability for loss or damage arising from the breakdown of the product.
- This guarantee is in addition to and does not diminish your statutory or legal rights.

Important Data Protection Information

To find out how we and Domestic & General Insurance Plc use your data please refer to the guarantee registration material or visit www.bushregistrations.co.uk.

Guarantor: Argos Limited - 489 - 499 Avebury Blvd. - Milton Keynes - MK9 2NW

or online at www.bush-support.com If you still require further assistance, call one of our experts on 0345 257 7271.

BUSH



Contact:

www.bush-support.com

Helpline: 0345 257 7271