

INSTRUCTION FOR USE

IMPORTANT SAFETY INSTRUCTIONS

BEFORE USING THE GLASS CERAMIC HOB

INSTALLATION

ELECTRICAL CONNECTIONS

ENERGY SAVING TIPS

SAFEGUARDING THE ENVIRONMENT

CARE AND MAINTENANCE OF THE GLASSCERAMIC HOB

TROUBLESHOOTING GUIDE

AFTER SALES SERVICE

PRODUCT DESCRIPTION SHEET

IMPORTANT SAFETY INSTRUCTIONS

YOUR SAFETY AND THAT OF OTHERS IS VERY IMPORTANT

This manual and the appliance itself provide important safety messages, to be read and always observed.

WARNING:

All messages relevant to safety specify the potential risk to which they refer and indicate how to reduce the risk of injury, damage and electric shocks due to incorrect use of the appliance. Make sure to comply with the following:

- The appliance must be disconnected from the power supply before carrying out any installation operation.
- Installation and maintenance must be carried out by a specialised technician, in compliance with the manufacturer's instructions and the local safety regulations in force. Do not repair or replace any part of the appliance unless specifically stated in the user manual.
- The appliance must be earthed.
- The power cable must be long enough for connecting the appliance, fitted in the cabinet, to the power supply.
- For installation to comply with the current safety regulations, an omnipolar switch with minimum contact gap of 3 mm is required.
- Do not use multi-sockets or extension cords.
- Do not pull the appliance's power cable.
- The electrical parts must not be accessible to the user after installation.
- The appliance is designed solely for domestic use for cooking food. No other use is permitted (e.g. heating rooms). The Manufacturer declines any liability for inappropriate use or incorrect setting of the controls.
- The appliance and its accessible parts become hot during use. Care should be taken to avoid touching heating elements. Children less than 8 years old shall be kept away unless continuously supervised.
- The accessible parts can become very hot during use. Children must be kept away from the appliance and watched over to ensure they do not play with it.
- Do not touch the appliance heating elements during and after use. Do not allow the appliance to come into contact with cloths or other flammable materials until all the components have cooled sufficiently.

- Do not place flammable materials on or near the appliance.
- Overheated oils and fats catch fire easily. Pay attention when cooking food products rich in fat and oil.
- This appliance can be used by children aged from 8 years and above and persons with reduced physical, sensory or mental capabilities or lack of experience and knowledge if they have been given supervision or instruction concerning use of the appliance in a safe way and understand hazards involved. Cleaning and user maintenance shall not be made by children without supervision.
- If the surface is cracked, switch off the appliance to avoid the possibility of electric shock.
- The appliance is not intended to be operated by means of an external timer or separate remote control system.
- Unattended cooking on a hob with fat or oil can be dangerous and may result in fire. NEVER try to extinguish a fire with water, but switch off the appliance and then cover flame e.g. with a lid or a fire blanket. Danger of fire: do not store items on the cooking surfaces.
- Do not use steam cleaners.
- Metallic objects such as knives, forks, spoons and lids should not be placed on the hob surface since they can get hot.

BEFORE USING THE GLASS CERAMIC HOB

- To make the most of your new appliance, please read the user instructions carefully and keep them handy for future consultation.

INSTALLATION

Cooktop

- The cooktop must be set into a worktop between 20 mm and 50 mm deep
- There must be nothing between the cooktop and the oven (cross rails, brackets, etc.).
- The distance between the lower face of the glass ceramic hob and the cupboard or separating panel must be at least 20 mm.
- If the cooktop is to be installed next to a column unit, leave a distance of at least 100 mm from the edge of the cooktop to the side of the column unit.
- Make an opening in the worktop, respecting the dimensions indicated in the enclosed product description sheet.
- Apply the supplied gasket to the cooktop (unless it has already been fitted), after having cleaned its surface.

Important

In order to prevent the electronic circuits from overheating, and therefore from being damaged, we recommend the following:

- **Do not install the cooktop near a dishwasher or washing machine, so that the electronic circuits do not come into contact with steam or moisture, which could damage them.**

If an oven (from our range of ovens) is installed beneath the cooktop, make sure that it is equipped with a cooling system. If the temperature of the electronic circuits exceeds the maximum permitted temperature, the cooktop will switch off automatically; in this case, wait for a few minutes until the internal temperature of the electronic circuits reaches a tolerable level, at which point it will be possible to switch the hob on again.



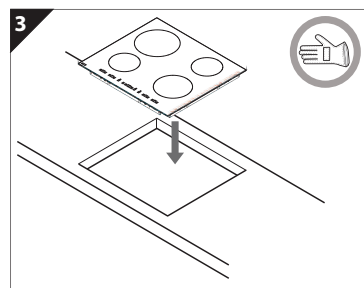
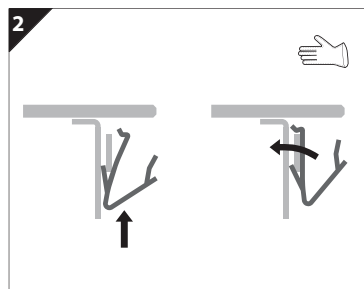
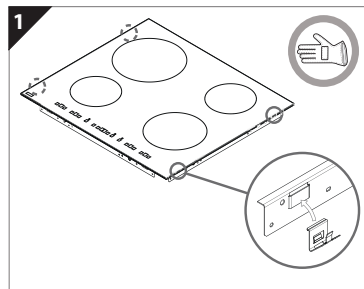
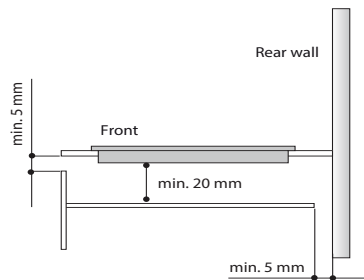

- **Switch the hob off after use.**



ELECTRICAL CONNECTIONS

Electrical connection must be made before connecting the appliance to the electricity supply. The appliance must be installed by a qualified electrician who is fully aware of current safety and installation regulations. Specifically, installation must be carried out in compliance with the regulations of the local electricity supply company. Make sure that the voltage shown on the rating plate is the same as the power supply voltage in your home. Regulations require that the appliance be earthed: use conductors (including the earth conductor) of the appropriate size only. The manufacturer declines all liability for injury to persons or animals and for damage to property resulting from failure to observe the above regulations. For the electrical connection use a H05RR-F type cable as indicated in the table below:

Power supply voltage.

Conductors	Amount x size
220-240V ~ + 	3 x 4 mm ²
230-240V ~ + 	3 x 4 mm ² (Australia only)
220-240V 3~ + 	4 x 1,5 mm ²
380-415V 3N~ + 	5 x 1,5 mm ²
380-425V 2N~ + 	4 x 1,5 mm ²

The appliance must be connected to the electricity supply by means of an all-pole disconnect switch with minimum contact gap of 3 mm.

Attention: the power supply cable must be long enough to allow the cooktop to be removed from the worktop and must be positioned so as to avoid damage or overheating caused by contact with the base.

Connecting to the terminal board

Note: the yellow/green earth wire must be connected to the terminal with the symbol  and must be longer than the other wires.

- Remove approx. 70 mm of the cable sheath from the power supply cable (B).
- Strip approx. 10 mm of sheath from the wires. Then insert the power supply cable into the cable clamp and connect the wires to the terminal block as indicated in the connection diagram placed close to the terminal block itself.
- Secure the power supply cable (B) by means of the cable clamp.
- Close the terminal board with the cover (A) securing it with the screw provided.
- After the electrical connection, fit the hob from the top and hook it to the support springs, according to the illustration.

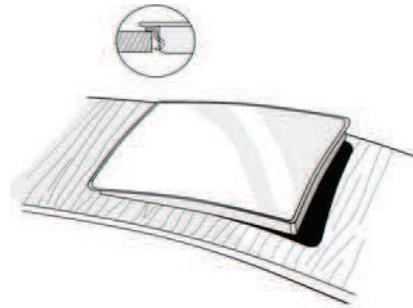
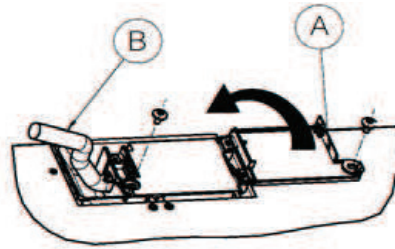

ENERGY SAVING TIPS

- Use pots and pans whose bottom diameter is equal to that of the cooking zone or slightly larger.
- Only use flat-bottomed pots and pans.
- If possible, keep pot lids on when cooking.
- Cook vegetables, potatoes, et. with little water in order to cut down cooking time.
- A pressure cooker allows you to save even more energy and time.



SAFEGUARDING THE ENVIRONMENT

1. Packing

- The packaging material can be 100% recycled, as confirmed by the recycling symbol .

2. Products

This appliance is marked according to the European directive 2012/19/EU on Waste Electrical and Electronic Equipment (WEEE). By ensuring this product is disposed of correctly, you will help prevent potential negative consequences for the environment and human health.

The symbol  on the product, or on the documents accompanying the product, indicates that this appliance may not be treated as household waste. Instead it shall be handed over to the applicable collection point for the recycling of electrical and electronic equipment. Disposal must be carried out in accordance with local environmental regulations for waste disposal. For more detailed information about treatment, recovery and recycling of this product, please contact your local authority, the household waste disposal service or the shop where you purchased the product.

Declaration of conformity CE

- This cooktop is suitable for contact with foodstuffs and complies with EEC (CE) Regulation n. 1935/ 2004.
- The appliances are designed solely for use as cooking appliances. Any other use of the appliances (e.g. for room heating) is considered as improper use and potentially dangerous.
- The appliances are designed, built and sold in compliance with:
- safety objectives of the “Low Voltage” Directive 2006/95/EC (which replaces 73/23/EEC and subsequent amendments);
- the protection requirements of Directive “EMC” 2004/108/EC;

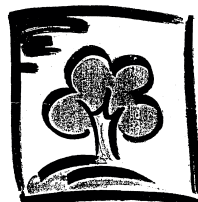

CARE AND MAINTENANCE OF THE GLASS-CERAMIC HOB

Clean the cooktop, when it is cool, after each use. This will prevent the build-up of dirt and make cleaning easier.

Important: avoid the use of high pressure water or steam cleaning equipment.

- Use a clean cloth, absorbent kitchen wipes and washing up liquid or a specific glass ceramic cleaner.
- Remove baked-on dirt with the special scraper tool (if provided) and specific cleaning products.
- Food spills should be cleaned off before they bake onto the glass ceramic surface.
- Foods with high sugar content (toffee, fruit juice, jam, etc.) that boil over while cooking, or spattered sugar stains must be immediately removed using a scraper.
- Do not use abrasive products, bleach, oven-cleaner spray or pan scourers.

The cooktop should be treated periodically with a proprietary brand of protective wax for glass-ceramic hobs.

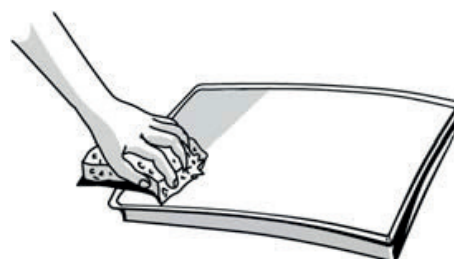

TROUBLESHOOTING GUIDE

Cooktop not working

- When pressing the control buttons, did you follow the instructions in the section “Using the hob” in the enclosed “Product Description Sheet”?
- Is there perhaps a power failure?
- Did you dry the hob carefully after cleaning it?

1. If a cooking zone has been selected and an “F” or an “ER” appear on the display followed by a number, contact the After Sales Service and inform them.

- With the exception of the message “F03” or “ER03” that identifies the incorrect cleaning of the controls area.
- To solve the problem follow the instruction in the ICleaning and maintenance of the glassceramic hobI paragraph.

2. If the hob does not work following intensive use, the hob internal temperature is too high. Wait a few minutes until the hob cools down.

AFTER-SALES SERVICE

Before contacting After-sales Service:

1. Try to solve the problem (see “Troubleshooting Guide”).
2. Turn off the appliance and restart it to see if the fault is repeated

If after the above checks the fault still occurs, get in touch with the nearest After Sales Service.

Please give: a short description of the fault,

- the precise type and model of the appliances,
- the service number (the number after the word “Service” on the data plate), located under the hob or on the Product Description Sheet.

- your complete address and phone number. If any repairs are required, please contact an authorized After-sales Service as indicated in the warranty. In the unlikely event that an operation or repair is carried out by an unauthorised technician, always request a certification of the job carried out and insist on the use of original spare parts. **Failure to comply with these instructions may compromise the safety and quality of the product.**

SERVICE 0000 000 00000



PRODUCT DESCRIPTION SHEET

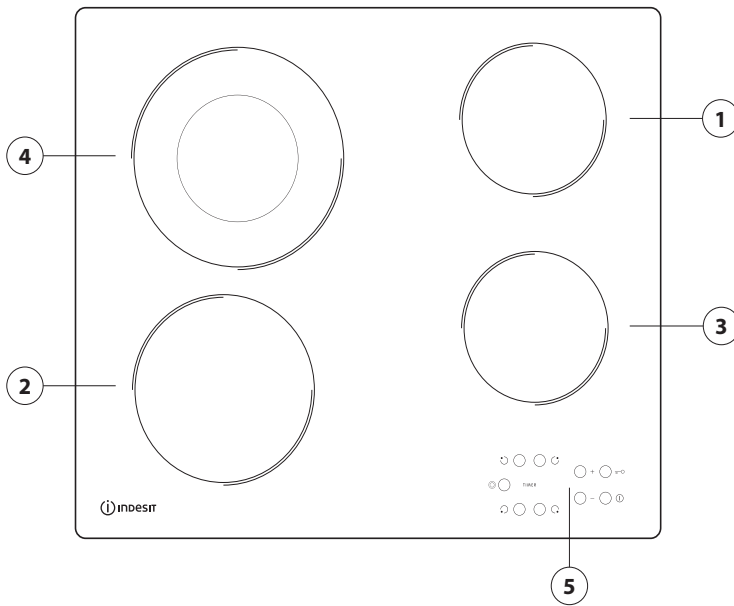

1. Radiant cooking zone \varnothing 145
2. Radiant cooking zone \varnothing 180
3. Radiant cooking zone \varnothing 145
4. Radiant cooking zone \varnothing 210
5. Display

DIMENSIONS OF THE HOB (mm)

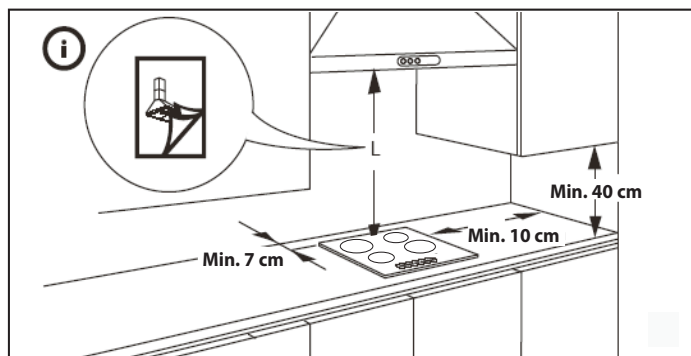
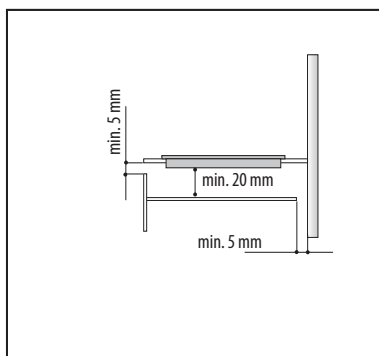
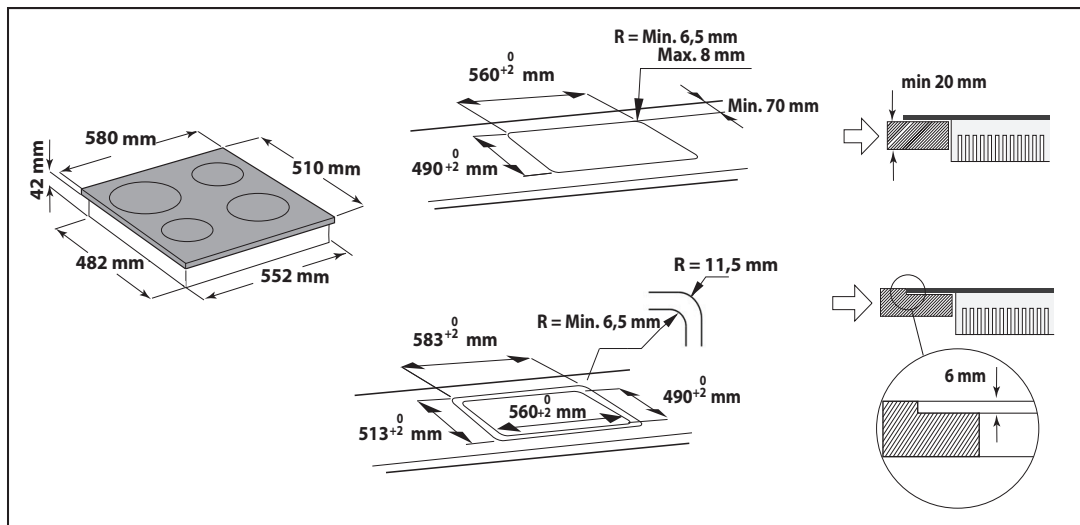

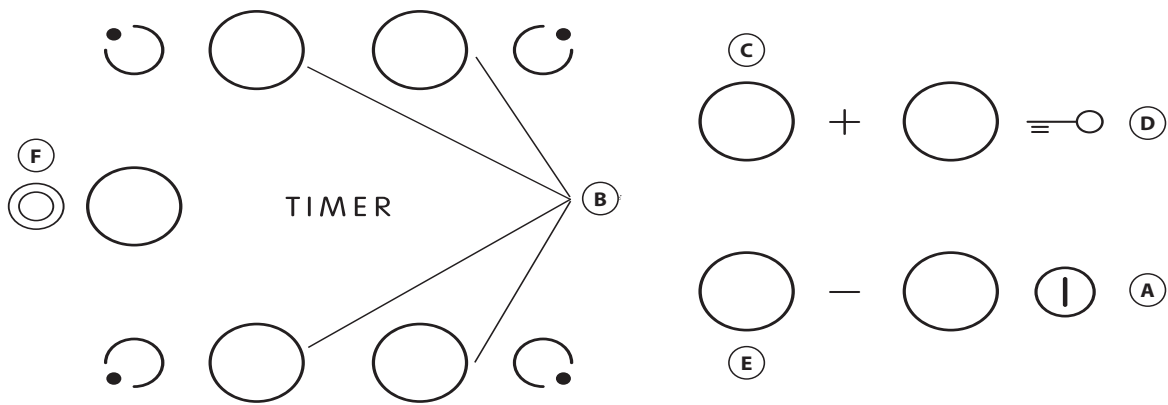

A	On/Off	D	Key lock
B	Cooking zone and timer selection	F	Multiple zone Activation / Deactivation
C-E	Heat setting increase and decrease		

Upon first installation, the control panel performs a functional test for about 1 second, after which it automatically switches to the "Key lock" function.

To deactivate the function, press and hold button "D"; an acoustic signal will sound and the corresponding led will turn off.

NOTE: If a reset occurs, repeat the procedure described above.

To switch the hob on, keep button "A" pressed for approx. 2 seconds. The 4 cooking zone displays show "0". If within 20 seconds none of the cooking zones is activated, the hob switches off automatically as a safety precaution. Press one of the buttons "B" corresponding to the cooking zone you intend to use. Select the heat setting required with buttons "E" or "C". The other selectable cooking settings go from 1 to 9. Press buttons +/- at the same time to cancel all settings. Pressing button "+" when level 9 is reached, the "Booster" function is activated and the letter "A" appears on the display.

IMPORTANT: the control is deactivated 10 seconds after the heat setting has been selected.

To change the heat setting, first press the selection button "B" again, then proceed to change the setting, using buttons "E" or "C".

MULTIPLE ZONE: After selecting the desired zone and setting the level (as described in the previous section) press "F": an indicator above the button turns on, activating the additional zone. The multiple zone can only be used if:

- 1) The cooking zone is provided with multiple zone;
- 2) The power level selected is greater than 0.

To deactivate the multiple zone, press button "B" of the desired zone, then press "F" again.

To set the Timer function, select the desired cooking zone and power setting then press the cooking zone key again and a luminous dot will appear on the display of the timer-controlled cooking zone. The indication "00" blinks on the 2 displays. Press buttons "C" or "E" to set the time from 1 to 99.

IMPORTANT: after 10 seconds the timer displays will show the power setting of the other cooking zones.

To view the remaining cooking time, press the timer-controlled cooking zone key twice.

The **KEY LOCK** function is switched on by holding down button "D" until a dot lights up above the function button. The Key lock function locks all the hob's other functions, with the exception of the On/Off button "A". The function remains on even after the hob is switched off and on again and can be deactivated by pressing button "D" again until the dot above the function button goes off.

H RESIDUAL HEAT INDICATOR

When the cooking zone is switched off, the residual heat indicator "H" remains on or flashes alternating with "0" until the temperature of the hob returns within safety levels.

IMPORTANT: The hob's safety features include an automatic switching off function. Prolonged use of the same heat setting triggers automatic switch-off of the cooking zone (for example, after around 1 hour at maximum heat setting, the cooking zone switches off).

BE CAREFUL: To avoid permanently damaging the glass-ceramic top, do not use:

- Pots with bottoms that are not perfectly flat.
- Metal pots with enamelled bottom.

Any aesthetic defects (scratches, surface marks, etc.) must be reported immediately upon installation.



04/17