

Use and Installation Instructions

CH60 ETC S
CH60 ETX
CH60ETC.0 S

This appliance must be installed in accordance with the regulations in force and only used in a well ventilated space.

Read these instructions before installing or using the appliance and retain them for future reference.

 **Hotpoint**

Please phone us on
08448 24 24 24
to activate your
guarantee

CONTENTS

	PAGE
WARNING	3
Introduction	4
Installation	5
Safety Information	6-7
Features	8
The Controls	9-11
The Cooking Modes in your Cooker	12-13
Electronic Clock and Automatic Cooking Feature	14-16
Temperature Conversion Chart	17
Use and Care of the Ceramic Hob	18-20
Solar Plus Grill	21-22
Top Oven - Conventional Cooking	23
Top Oven Cooking Temperature Charts	24-25
Main Oven - The Precision Cooking System	26-28
Care and Cleaning	29-31
Something wrong with your Cooker	32
Disposal of the appliance	33
Guarantee Information	34
Service Information	34

Retention of this Instruction Book

This Instruction Book must be kept handy for reference as it contains important details on the safe and proper use of the appliance.

If you sell or pass the appliance to someone else, or move house and leave it behind, make sure this Book is also provided so the new owner can become familiar with the appliance and safety warnings.

WARNING

WARNING: The appliance and its accessible parts become hot during use.

Care should be taken to avoid touching heating elements. Children less than 8 years of age shall be kept away unless continuously supervised.

This appliance can be used by children aged from 8 years and above and persons with reduced physical, sensory or mental capabilities or lack of experience and knowledge if they have been given supervision or instruction concerning use of the appliance in a safe way and understand the hazards involved. Children shall not play with the appliance. Cleaning and user maintenance shall not be made by children without supervision.

WARNING: Unattended cooking on a hob with fat or oil can be dangerous and may result in fire.

NEVER try to extinguish a fire with water, but switch off the appliance and then cover flame e.g. with a lid or a fire blanket.

WARNING: Danger of fire: do not store items on the cooking surfaces.

WARNING: If the surface in glass-ceramic is cracked, switch off the appliance to avoid the possibility of electric shock.

Do not use harsh abrasive cleaners or sharp metal scrapers to clean the oven door glass since they can scratch the surface, which may result in shattering of the glass.

The internal surfaces of the compartment (where present) may become hot.

Never use steam cleaners or pressure cleaners on the appliance. Remove any liquid from the lid before opening it.

Do not close the glass cover (if present) when the gas burners or electric hotplates are still hot.

WARNING: Ensure that the appliance is switched off before replacing the lamp to avoid the possibility of electric shock.

! When you place the rack inside, make sure that the stop is directed upwards and in the back of the cavity.

NOTICE

! VERY HOT SURFACES

FOOD OR GREASE ON THESE SURFACES COULD CAUSE SMOKE AND POSSIBLY EVEN BURN

YOU MUST KEEP THE OVEN AND GRILL CAVITIES CLEAN

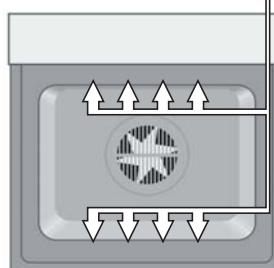

! ATTENTION

DURING INSTALLATION THE FEET OF THE APPLIANCE MUST BE LOWERED SO THAT AN AIR GAP OF AT LEAST 10MM (1CM) IS LEFT BETWEEN THE BASE OF THE APPLIANCE AND THE FLOOR.



! ATTENTION

WHEN USING THE MAIN OVEN YOU MUST ENSURE THAT THE BASE OF THE CAVITY IS NOT COVERED WITH ALUMINUM FOIL, UTENSIL OR ANY OTHER FORM OF COVERING. FAILURE TO DO THIS MAY RESULT IN THE CAVITY BEING DAMAGED.



INTRODUCTION

Your new appliance is guaranteed* and will give lasting service. This guarantee is only applicable if the appliance has been installed in accordance with the installation instructions detailed in this booklet. To help make best use of your cooking equipment, please read this booklet carefully. The cooker is designed specifically for domestic use and responsibility will not be accepted for use in any other installation.

**When the cooker is first used an odour may be emitted,
this will cease after a period of use**

When first using the cooker ensure that the room is well ventilated (e.g. open a window or use an extractor fan) and that persons who may be sensitive to the odour avoid any fumes.

It is suggested that any pets be removed from the room until the smell has ceased. This odour is due to temporary finish on oven liners and elements and also any misture absorbed by the insulation.

*** The guarantee is subject to the provisions that the appliance:**

- (a) Has been used solely in accordance with the Users Instruction Book.**
- (b) Has been properly connected to a suitable supply voltage as stated on the rating plate attached to this equipment.**
- (c) Has not been subjected to misuse or accident or been modified or repaired by any person other than the authorised employee or agent.**
- (d) Has been correctly installed.**

This appliance conforms with the following European Economic Community directives:

- 2006/95/EC of 12/12/06 (Low Voltage) and subsequent modifications;
- 2004/108/EC of 15/12/04 (Electromagnetic Compatibility) and subsequent modifications;
- 90/396/EEC of 29/06/90 (Gas) and subsequent modifications (only for models which use gas);
- 93/68/EEC of 22/07/93 and subsequent modifications.
- 2002/96/EC
- 1275/2008 (Stand-by/Off mode)



Technical Characteristics

Top Oven

Usable Volume: 39 Litres

Declared energy consumption for
Natural convection Class
heating mode: Conventional

ENERGY LABEL and ECODESIGN- Top Oven

Regulation (EU) No 65/2014 supplementing Directive 2010/30/EU.
Regulation (EU) No 66/2014 implementing Directive 2009/125/EC.
Standard EN 60350-1
Standard EN 50564.

Main Oven

Usable Volume: 67 Litres

Declared energy consumption for
Forced convection Class
heating mode: Eco

ENERGY LABEL and ECODESIGN - Main Oven

Regulation (EU) No 65/2014 supplementing Directive 2010/30/EU.
Regulation (EU) No 66/2014 implementing Directive 2009/125/EC.
Standard EN 60350-1
Standard EN 50564.

Voltage and Frequency

230-240V~ 50Hz

Moving the Cooker

Before moving your cooker, switch off at the cooker control unit, ensure that it is cool.

Open the grill door sufficiently to allow a comfortable grip on the underside front edge of the oven roof, avoiding any grill elements.

Radio Interference

This appliance conforms to EN 55014 regarding suppression of radio and television interference.

Note: Take care in moving the cooker as it is heavy. Take care to ensure that any floor covering is not damaged.

INSTALLATION

WARNING - THIS APPLIANCE MUST BE EARTHED.

Mains Connection

Your cooker should have been checked to ensure that the voltage corresponds with your supply voltage, this is stated on the rating plate, which is situated on the outer rear panel.

The model number and serial number are located on the front of the cooker, as shown on the Feature's page.

The cooker must be connected by a competent person such as one who is a, NICEIC registered contractor to a suitable double-pole control unit with a minimum rating of 32A and a minimum contact clearance of 3mm (applicable to newer properties, older properties where a 30A double pole control unit and a minimum contact clearance of 3mm is acceptable).

The double pole control unit should be fitted adjacent to the cooker, in accordance with IEE regulations. The control unit must be within 2 metres of but not directly above the appliance and should be easily accessible in the event of an emergency.

The power supply cable should conform to B.S.6004 with a conductor size of 6mm², minimum.

Access to the mains terminals is gained by removing the rear access cover. The mains cable must pass through the cable clamp adjacent to the terminal block. Sufficient cable should be used to allow the cooker to be pulled out for servicing.

Ensure that the mains cable is routed away from any brackets affixed to the rear panel and is not trapped to the rear wall when pushing the cooker into position between cabinets.

Levelling

Four feet are fitted which can be adjusted up or down to set the height (900mm - 930mm) and level the cooker. The feet can be simply screwed in or out to lower or raise the cooker.

After the correct height is achieved, lock the feet into position by tightening the locking nut using an open ended spanner.

CAUTION: Some soft floor coverings may get damaged if the cooker is not moved carefully.

NOTE: Ensure oven shelves are level by using a spirit level on the rod shelves.

Siting the Cooker

The cooker is designed to fit between kitchen cabinets spaced 600mm apart. The space either side need only be sufficient to allow withdrawal of the cooker for servicing and cleaning.

It can be used with cabinets one side or both as well as in an angled corner setting. It can also be used freestanding.

Adjacent side walls which project above hob level, must not be nearer to the cooker than 150mm and should be protected by heat resistant material. Any overhanging surface or cooker hood should not be nearer than 650mm.

Note: This appliance must NOT be fitted on a platform.

The appliance must not be installed behind a decorative door in order to avoid overheating

After installing the power cable, screw the metal cover with three screws.

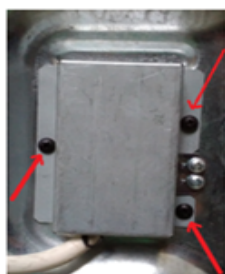

SAFETY INFORMATION

**When used properly your appliance is completely safe but as with any electrical product there are certain precautions that must be observed.
PLEASE READ THE PRECAUTIONS BELOW BEFORE USING YOUR APPLIANCE.**

Always

- Remove all packing from the appliance before switching on for the first time.
- Understand the controls prior to using the appliance.
- Keep children away from the appliance when cooking as the surfaces will get extremely hot during and after use.
- Turn controls **off** when not in use.
- Stand back when opening an oven door to allow any build up of steam or heat to disperse.
- Always use dry good quality oven gloves when removing items from the oven/grill.
- Always place pans centrally over the hotplate making sure handles are kept away from the edge of the hob and cannot become heated by other hotplates or pans.
- Always take care to avoid heat or steam burns when operating the controls.
- Always turn off the electricity supply at the wall switch and allow the appliance to cool before cleaning (or changing an oven lamp if fitted).
- Always make sure the shelves are in the correct position before switching on the oven or grill.
- Always keep the oven/grill door closed when the appliance is not in use.
- Always keep the appliance clean as a build up of grease or fat from cooking can cause a fire.
- Always follow the basic principles of food handling and hygiene to prevent the possibility of bacterial growth.
- Always keep ventilation slots clear of obstructions.
- Always refer servicing to a qualified appliance service engineer.
- Always take care when removing items from the grill compartment when the lower oven is in use as the contents will be hot.
- Always turn off the electricity supply to the appliance at the wall switch should any glass panel (if fitted) crack or shatter and then **DO NOT USE THE APPLIANCE** until repaired.
- During use, the oven becomes hot. Care should be taken to avoid touching heating elements inside the oven.

- The appliance should not be operated by people (including children) with reduced physical, sensory or mental capacities, by inexperienced individuals or by anyone who is not familiar with the product. These individuals should, at the very least, be supervised by someone who assumes responsibility for their safety or receive preliminary instructions relating to the operation of the appliance.
- **The appliance must be used by adults only for the preparation of food, in accordance with the instructions outlined in this booklet. Any other use of the appliance (e.g. for heating the room) constitutes improper use and is dangerous. The manufacturer may not be held liable for any damage resulting from improper, incorrect and unreasonable use of the appliance.**

SAFETY INFORMATION

Never

- Never stare at Halogen heating units.
- Never leave children unsupervised where a cooking appliance is installed as all surfaces will be hot during and after its use.
- Never allow anyone to sit or stand on any part of the appliance.
- Never store items above the appliance that children may attempt to reach.
- Never leave anything on the hob surface when unattended and not in use.
- Never remove the oven shelves whilst the oven is hot.
- Never heat up unopened food containers as pressure can build up causing the container to burst.
- Never store chemicals/food stuffs or pressurised containers in or on the appliance, or in cabinets immediately above or next to the appliance.
- Never place flammable or plastic items on or near the hob.
- Never fill a deep fat frying pan more than 1/3 full of oil, or use a lid. **DO NOT LEAVE DEEP FAT FRYING PANS UNATTENDED WHILE COOKING.**
- Never use the appliance as a room heater.
- Never use the grill to warm plates.
- Never dry any items on either the hob or oven doors.
- Never install the appliance next to curtains or other soft furnishings.
- Never operate the grill with the grill door closed as this will cause the appliance to over heat.
- Never use 'steam cleaners'.

SAFETY ADVICE IN CASE OF A CHIP-PAN FIRE

In the event of a chip pan fire or any other pan fire.

1. TURN OFF THE COOKER APPLIANCE AT THE WALL SWITCH.
2. COVER THE PAN WITH A FIRE BLANKET OR DAMP CLOTH, this will smother the flames and extinguish the fire.
3. LEAVE THE PAN TO COOL FOR AT LEAST 60 MINUTES BEFORE MOVING IT. Injuries are often caused by picking up a hot pan and rushing outside with it.

NEVER USE A FIRE EXTINGUISHER TO PUT OUT A PAN FIRE as the force of the extinguisher is likely to tip the pan over.

Never use water to extinguish oil or fat fires.

! The appliance should not be operated by people (including children) with reduced physical, sensory or mental capacities, by inexperienced individuals or by anyone who is not familiar with the product. These individuals should, at the very least, be supervised by someone who assumes responsibility for their safety or receive preliminary instructions relating to the operation of the appliance.

FEATURES

WARNING: DO NOT touch the oven doors when the oven is in use as these areas can become hot.

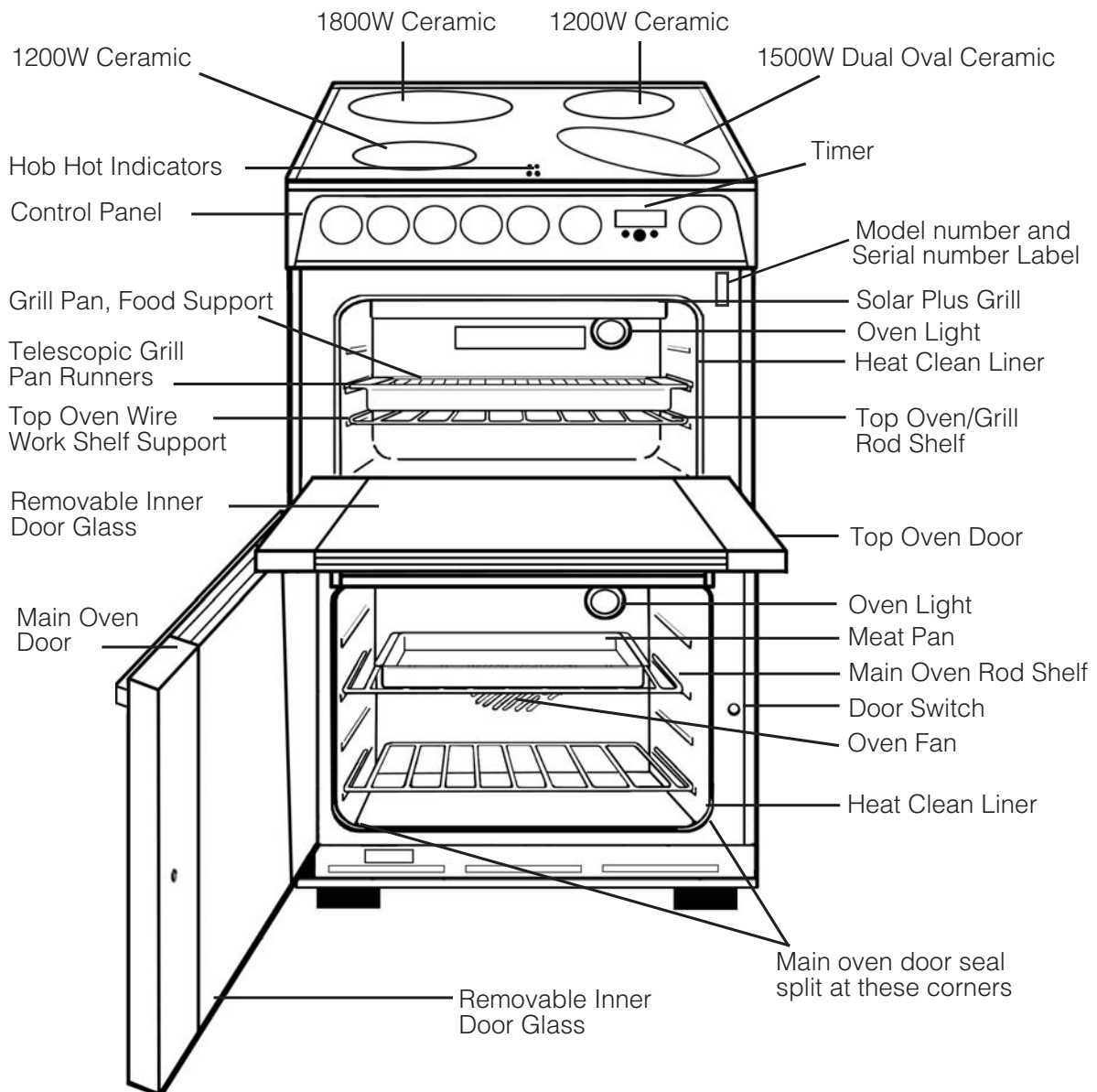

NOTE: To keep the controls cool when the appliance is used, a gentle flow of air may be blown from beneath the control panel. If the appliance is still warm, this cooling fan may run on or restart itself when all controls have been turned off.

This is normal and is not a fault.

The fan will stop once the appliance has cooled.

NOTE: Children should not be allowed to play with the appliance or tamper with the controls.

PLEASE PHONE US TO REGISTER YOUR APPLIANCE AND ACTIVATE YOUR PARTS GUARANTEE ON 08448 24 24 24

THE CONTROLS

Switch on the electricity supply to the cooker at the Cooker Control Unit.

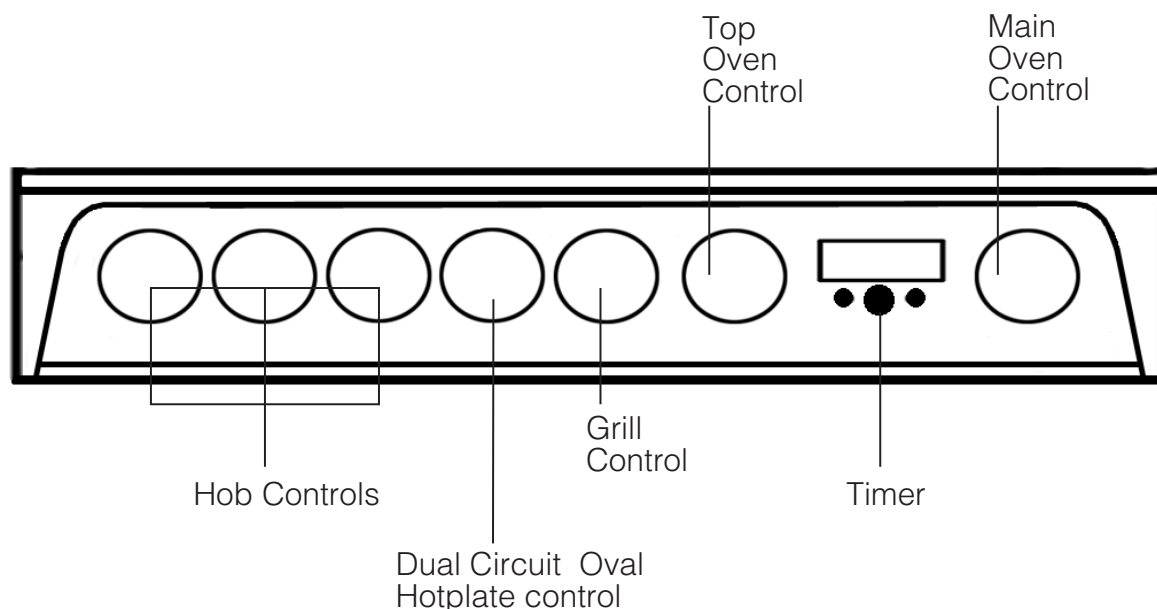

Hob Controls

As each control knob is turned clockwise, numbers from 1 - 6 on the control knob increase. Setting 6 is the highest/hottest and gives 100% power. Setting 1 is the lowest/coolest and gives about 7% power. Variable power is obtainable on each of the heating areas by selecting any number between 1 & 6.

Right Front Control

This is to control a dual circuit oval hotplate with two elements. By turning the knob clockwise both parts of the hotplate are switched on, numbers 1-4 on the control knob, 4 is the highest setting. With the knob turned anticlockwise, only the inner part of the hotplate is switched on, this is also indicated by numbers 1-4 on the control knob, 4 is the highest setting. Variable power for either the whole or the inner part of the hotplate is obtained by selecting any number between 1 & 4. The off position is identified by an '0'. The hob hot warning lights will operate soon after each of the heating areas have been switched on. Each warning light will remain illuminated until each heating area has cooled down.

Main Oven Light

The main oven light can be switched on, when the oven is not in use, by pressing the oven light button on the display. The oven light will also operate whenever the main oven door is opened.

NOTE: The oven light can be switched off when the door is opened by pressing the oven light button on the display, or by closing the door.

Cooling Fan

The cooling fan operates with the ovens and grill. The fan will operate at full speed for a few seconds and then reduce to a lower speed. The cooling fan will only increase to full speed if the temperature inside the cooker reaches above a certain limit.

THE CONTROLS

Main Oven Functions (1-7):

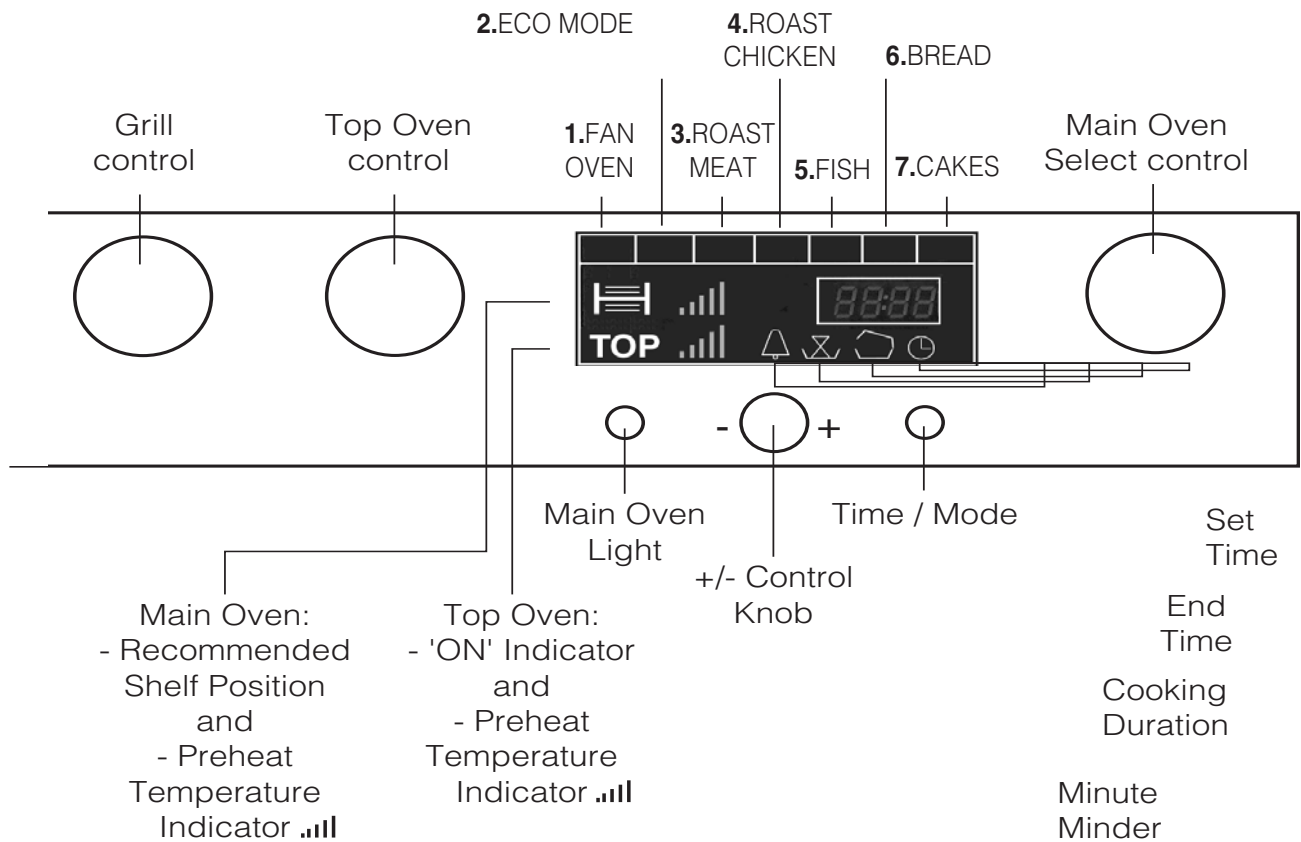

Grill Control - Top Oven

The grill control will not operate unless the top oven control is in the 'O' off position. The grill control provides fully variable heat control for either the twin grill or single (left hand side) grill by selecting any number between 1 & 4. When turned clockwise the twin grill will be switched on and any power setting from 1 - 4 can be selected. The power level numbers are indicated on the control knob. When turned anti-clockwise the single grill will be switched on and any power setting from 1 - 4 can be selected. The power level numbers are indicated on the control knob. The off position is identified by an 'O'.

Top Oven Control

This control switches on the top and bottom heating elements in the top oven. The temperature in the oven can be set anywhere between 100°C and 220°C. The top oven ON indicator (TOP) and the top oven preheat temperature indicator (.||| symbol) will be on the display (bottom left hand corner). The top oven preheat temperature indicator (.||| symbol) will switch OFF and an audible tone will sound when the top oven has reached the required temperature. When in operation the oven light will be illuminated. The off position is identified by an 'O'.

Notes

If both the top oven and grill controls are turned on together, the (TOP) and (.||| symbol) will flash on the display. The cooker will continue to operate in the function which was selected first.

THE CONTROLS

Main Oven Control

This control switches on the top and rear heating elements at various times in the main oven, dependent on which mode has been set.

The temperature of the main oven can be set anywhere between 80°C and 230°C in cooking modes 1 - 5.

The main oven preheat temperature indicator (📊 symbol) will be on the display (middle, left hand side).

The main oven preheat temperature indicator (📊 symbol) will switch OFF and an audible tone will sound when the main oven has reached the required temperature.

The Main Oven Cooking Functions

The main oven has eight cooking functions. Use the main oven control to select the cooking mode you require. The display will show the function you have selected, across the top (1 - 7) with the eighth function being shown on the clock display as '(RISE)'. **The ECO Mode (position 2) hasn't got the icon on the display.**

Adjusting the Main Oven Temperature

When a program is set (position 1 - 5), the display will automatically suggest a cooking temperature. If you wish you can use the +/- control knob to change the suggested temperature to one of your own choice, within a range which is suitable for the particular cooking mode.

THE COOKING MODES IN YOUR COOKER

Your new cooker is equipped with a number of different cooking modes:



Conventional Heating (Top Oven)

- with upper and lower heat. This system is particularly suitable for roasting and baking on one shelf only.



Variable Grilling (Top Oven)

- the oven can also be used for conventional grilling with a full or half width fully controllable grill.

Note: The Top Oven door should be open when grilling.



Fan Oven (Main Oven)

- the fan oven operates by constantly blowing heated air, from an element wrapped around the fan, into the oven. This gives improved efficiency and in general, enables the use of lower temperatures for cooking. It also means that there is less need to be particular about shelf positions and that you can bake at more than one level simultaneously (Batch Baking).



Eco program (Main Oven)

- this program is suitable for roasting large pieces of meat with energy savings. Preheat the oven before putting the food in it.

It is suggested to turn the meat during cooking to obtain a homogeneous browning on both sides. It is preferable to moisten it from time to time so as not to over - dry it.

Normally during ECO function lamp is switched off to save energy consumption. For switching on the light push manually the button "Main oven light"



Roast Meat (Main Oven)

- specially created for cooking joints of meat. This mode raises the temperature in the oven to a very high heat for the first part of the cooking cycle, to seal the outside of the joint and retain the juices of the meat throughout cooking. After this the temperature is reduced to the set temperature using each heating element in turn to guarantee a homogeneous temperature for the cooking period. A temperature is suggested on this mode but this can be altered using the '+/-' control knob.



Roast Chicken (Main Oven)

- specially created for cooking excellent roast poultry. This mode can be used to roast chickens, duck, turkey and other poultry to perfection. Each heating element is used in the cycle to guarantee a homogeneous temperature within the oven. A temperature is suggested on this mode but this can be altered using the '+/-' control knob.

THE COOKING MODES IN YOUR COOKER



Fish (Main Oven)

- this mode provides gently pulsing top and rear heat to lightly poach fish dishes without overcooking or drying out. A temperature is suggested on this mode but this can be altered using the '+/-' control knob.



Rising (Main Oven)

- this mode heats and holds the oven at 40°C. It is ideal for proving bread and yeast based dough mixtures. When this mode is selected a cooking duration of 14 minutes is automatically set, this can be altered by pressing the 'time/mode' button until the cooking duration icon flashes. Then use the '+/-' control knob to adjust the cooking duration.



Bread cycle - Auto

- this mode is fully automatic and lasts for 1 hour. When this mode is selected the time and temperature cannot be adjusted. It is suitable for baking bread weighing up to 1.5kg, either in a tin or on a baking tray. This mode includes a proving cycle and a baking cycle. If an initial proving cycle is needed this can be done using the RISE mode (8).



Cake cycle - Auto

- this mode is fully automatic and lasts for 1 hour. When this mode is selected the time and temperature cannot be adjusted. It is suitable for baking sponge based cakes that take between 30 minutes and 1 hour to cook.

! After selecting any of the oven programs, the parameter setting of the product is activated. It optimizes the performance of cooking, but could result in a delayed ignition of fan and heating elements.

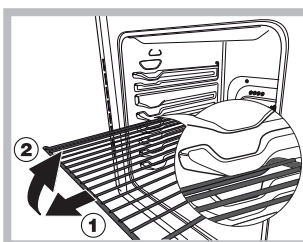

WARNING! The oven is provided with a stop system to extract the racks and prevent them from coming out of the oven. (1) As shown in the drawing, to extract them completely, simply lift the racks, holding them on the front part, and pull (2).

ELECTRONIC CLOCK & AUTOMATIC COOKING FEATURE

When you first switch on the appliance you will be prompted to set the 'Time of Day' on the display. You must ensure you have done this before attempting to use the automatic cooking feature.

AUTOMATIC COOKING

The main oven can be controlled automatically.

HINTS ON AUTOMATIC COOKING

- Select food which will require the same cooking time and temperature.
- To ensure food does not cool down and require reheating, set the end time so the food is ready when you require it.
- Always ensure that meat and poultry is defrosted before placing in the oven.
- Whenever possible, take food out of the refrigerator and keep it as cool as possible.
- If cooking food that requires frying before placing in the oven for automatic cooking, keep the delay time to a minimum.
- Never place hot or warm food in the oven for delayed start cooking as it could cause the oven to be warm and produce harmful bacteria in the food.
- We advise that dishes containing left-over cooked poultry and meat, eg. shepherds pie, should not be cooked automatically if there is to be a delay period.
- Ensure that delay start times are kept to a minimum to prevent bacterial growth in food.
- Wine or beer may ferment and cream may curdle during the delay period, so it is best to add these ingredients just before serving.
- Foods which discolour should be protected by coating in fat or tossing in water to which lemon juice has been added, prior to placing food in the oven.
- Dishes containing liquid should not be filled too full to prevent boiling over.
- Food should be well sealed (but not airtight) in a container to prevent the loss of liquid during cooking. Aluminium foil gives a good seal.
- Always ensure that food is piping hot and cooked thoroughly before serving.
- Only reheat food once.

SETTING THE TIME OF DAY:

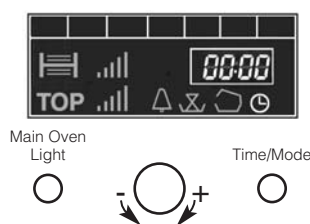

- STEP 1. Check the electricity supply to the cooker is turned on.
- STEP 2. When switched on the display will show both 00:00 and the 'set time' symbol flashing. Wait until these stop flashing.
- STEP 3. Press the Time/Mode button once, so that the 'Set Time' symbol and the display are flashing. Turn the +/- control knob until the correct hour is set.
- STEP 4. Press the Time/Mode button once, so that the 'Set Time' symbol and the display are flashing. Turn the +/- control knob until the correct minutes are set. Press the Time/Mode button again.

TIME OF DAY IS NOW SET.

To alter the time of day after the first setting, simply press the Time/Mode button. The 'Set Time' symbol and the display will flash. Repeat STEPS 3 and 4.

ELECTRONIC CLOCK & AUTOMATIC COOKING FEATURE

SETTING THE MINUTE MINDER:

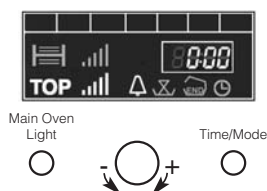

- STEP 1. Press the Time/Mode button, until the 'bell' symbol is flashing.
 STEP 2. Turn the +/- control knob to set the duration in minute increments until the required time is set. After a few seconds the 'bell' symbol will stop flashing and the time will count down.

THE MINUTE MINDER IS NOW SET.

At the end of the set time an audible tone will be heard and the 'bell' symbol will go out. After a few seconds the audible tone will stop and after a few seconds the display will revert back to the time of day.

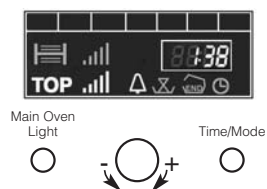

The minute minder can be cancelled at any time by following STEPS 1 and 2, setting the time period to zero using the +/- control knob. The display will revert back to the time of day. The display shows HOURS and MINUTES eg. 1 hour 38 minutes

AUTO COOKING TIMER

There are two Auto Cooking programmes for the main oven, that can be selected using the display:
 (a) To set the main oven to switch ON immediately and OFF automatically after a time of your choice.
 (b) To set the main oven to switch ON and OFF automatically, at the times of your choice.

(a) To set the main oven to switch ON immediately and OFF automatically:

This allows you to cook for a specified duration, after which the oven will automatically switch off.

To adjust the duration of the cooking cycle press the Set timer button once. Adjust the present time by rotating the Set Temperature/Time knob to the required time. Once the desired duration of time is displayed press the Set Time button once to activate the programme.

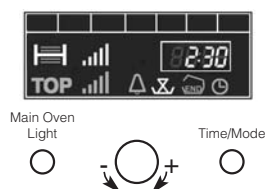

- STEP 1. Check that the correct time of day is set, if not follow instructions for setting the time of day.
 STEP 2. Place food to be cooked on shelf in the oven.
 STEP 3. Switch the main oven control to the desired mode. The display will automatically suggest a cooking temperature. This can be changed by turning the +/- control knob. (The oven will start).
 STEP 4. Press the Time/Mode button, until the 'cooking duration' symbol is flashing.
 STEP 5. Turn the +/- control knob to set the cooking duration you require. After a few seconds the 'cooking duration' symbol will stop flashing and the display will show the temperature that has been set. This will change every few seconds when the display will show the cooking duration remaining.

ELECTRONIC CLOCK & AUTOMATIC COOKING FEATURE

THE COOKING DURATION IS NOW SET.

At the end of the set cooking duration, 'End' will show in the display and an audible tone will be heard for a few seconds.

Turn the main oven control to 'O', the OFF position to switch the oven off. The display will revert back to the time of day.

To cancel the automatic mode at any time turn the main oven control to 'O', the OFF position.

Note: During the cooking period the cooking duration will be shown in the display for a few seconds and then revert to the temperature set.

(b) To set the main oven to switch ON and OFF immediately:

This allows you to cook for a specified duration and additionally choose the time you wish the cooking cycle to finish. From this information the system works out when the cooking cycle will need to start and automatically switches the oven on at the required time.

- Follow **STEPS 1 to 5** in the previous section (a) entitled: 'To set the main oven to switch ON immediately and OFF automatically', then continue as below:

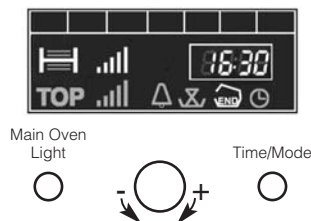

STEP 6. Press the Time/Mode button, until the 'end time' symbol is flashing. The display will show a default cooking end time (this will be the current time plus the cooking duration you set in STEP 5). The 'end time' symbol will flash.

STEP 7. Turn the +/- control knob to set the time you wish the cooking to end. After a few seconds the display the temperature, cooking duration and end time in turn.

THE COOKING DURATION AND END TIME IS NOW SET.

The display will show the temperature and cooking duration when the programme has started.

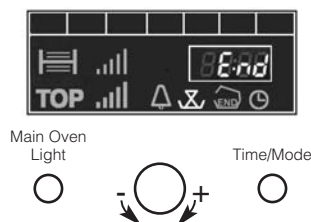

At the end of the cooking duration, 'End' and the 'cooking duration' symbol will show in the display and an audible tone will be heard for a few seconds.

Turn the main oven control to 'O', the OFF position to switch the oven off. The display will revert back to the time of day.

To cancel the automatic mode at any time turn the main oven control to 'O', the OFF position.

Note: At any time up to the start of cooking, the cooking end time, cooking duration and the temperature will be shown in the display.

TEMPERATURE CONVERSION CHART

This product complies with the requirements of the latest European Directive on the limitation of power consumption by the use of an Automatic 'Stand-by' mode.

Full 'Standby' is achieved when both:

The Oven is not in Use::

If the ovens are NOT in use, and the oven controls have not been operated for a period of approximately 2 minutes, the timer display automatically switches to its 'stand-by' mode. When in 'standby mode', the time of day is not visible and just the "watch icon" is illuminated on the timer display. As soon as interaction with the oven controls, or with any of the timer buttons resumes, the full timer display, (including the 'time of day'), will be restored and the 'watch icon' will go out

AND

The Hob is not in Use:

If no operations of the hob controls are carried out for a period of a few minutes after all hotplates have been turned off, and once the hob has cooled sufficiently, the "hot hob indicators" on the hob glass go out, indicating that the hob is in "stand-by mode".

When any of the hotplates are next used, the appropriate hob hot light(s) will be illuminated again. Operation of the hob controls does not affect the timer display

Gas Mark	°F	Main Conventional Oven	Top Conventional Oven	Main Fan Oven
½	250	120	110	100
1	275	140	130	120
2	300	150	140	130
3	325	160	150	140
4	350	180	170	160
5	375	190	180	170
6	400	200	190	180
7	425	220	210	200
8	450	-	220	210
9	475	-	-	220

Temperatures

The recommended temperatures given are for conventional and fan ovens. When using a fan oven it will be necessary to reduce the cooking time by 10 minutes per hour and lower the temperature by up to 20°C. Also, in the majority of cases, it is not necessary to pre-heat the oven. However, pre-heating is recommended when cooking items such as Yorkshire puddings, whisked sponges and bread. Your experience with the cooker will enable you to select the cooking time and temperature best suited for your recipe.

Condensation

Condensation may become evident on the inner door and water may drip through the vent. This is normal when heat and moisture are present and may be a result of any of the following:

1. Kitchen temperature and ventilation.
2. The moisture content of the food eg. meat, roast potatoes, Yorkshire pudding, roasting meat, etc.
3. The quantity of the food being cooked at any one time.

USING THE CERAMIC HOB

WARNING: DO NOT USE THE HOB IF IT IS CRACKED. TO AVOID ELECTRIC SHOCK - SWITCH OFF AT THE COOKER MAINS CONTROL SWITCH IMMEDIATELY AND CONTACT YOUR NEAREST SERVICE OFFICE (see back page).

Ratings of Cooking Zones			
Front Left	Front Right	Back Left	Back Right
Solarglo 1200 W 145mm diameter	Solarglo (Dual Oval) 1500 W 145mm x 250mm diameter	Solarglo 1800 W 180mm diameter	Solarglo 1200 W 145mm diameter

The Working of the Heating Zones

Heating only occurs within the marked circular cooking zones. The zones heat up and cool down quicker, providing greater controllability for sensitive foods. Each heating zone is equipped with a thermal limiter which is a safety cut-out which prevents the ceramic glass from overheating. After several minutes at full power without a pan on the heating zone the thermal limiter will switch the heating elements off and on automatically to avoid any damage to the ceramic glass.

Choice of Saucepans

It is essential that the saucepan's you use on the ceramic hob are suitable.

ALWAYS USE:

- Good quality pans with smooth, flat, heavy bases.
- saucepan's manufactured from aluminium (enamelled or machined) or stainless steel.
- Correct size saucepan's. The base of the pan must cover the heating zone completely.
- saucepan's with lids which are well fitting to reduce cooking time and energy use.

NEVER USE:

- Pans with thin, distorted or uneven bases as these will extend cooking times, waste electricity and cause damaging, local hotspots on the glass surface.
- Pans with ridged or recessed bases.
- Pans with damaged or rough bases which could scratch the glass surface.
- Glass or glass ceramic utensils.

CARE OF THE CERAMIC HOB

Do Not

In order to keep your ceramic hob in good condition, follow these simple guidelines:

- Do not** stare at halogen heating units.
- Do not** cook directly on the hob surface without a cooking utensil, as this will result in damage to the surface of the hob.
- Do not** use the hob as a worktop surface as damage may occur to the smooth surface of the hob.
- Do not** drag or slide utensils on the hob surface, as this will cause scratches in the surface of the hob.
- Do not** allow a cooking utensil to come into contact with the hob surround.
- Do not** place anything between the base of the utensil and the ceramic hob, e.g. do not use asbestos mats, aluminium or wok stand.
- Do not** leave any utensils, food or combustible items on the hob when it is not in use. 
- Do not** place aluminium or plastic foil, or plastic containers on the hob.
- Do not** leave the hotplates or cooking areas switched On unless they are being used.
- Do not** leave heating zones uncovered when they are switched On.

We recommend not to place large preserving pans or fish kettles across two heating areas.

- Do not** leave utensils partly covering the heated areas. Always ensure that they are placed centrally over the heated areas and have the same diameter as the heating area used. 

Do

- Always** ensure that the bottom of the pan is both clean and dry. Dirt or moisture between the pan and the hob can cause pitting of the surface of the glass.

We do not recommend the use of utensils with a base diameter greater than 25cm (10ins).

Pressure cookers or other large pans should be used on the front cooking areas.

- Always** ensure that saucepan handles are positioned safely.
- Always** take extra care when cooking foods with a high sugar content eg. jam, as spillage will cause damage to the surface of the glass.
- Always** clean spills immediately (see Care and Cleaning).

CARE OF THE CERAMIC HOB

IMPORTANT - As with any cooking appliance there could be some fire risk attached to the heating of oil, particularly for deep fat frying, cooking utensils containing oil **must not be left unattended** (e.g. to answer the telephone) on or in close proximity to the patterned cooking areas.

1. Use a deep pan, large enough to completely cover the appropriate heating area.
2. Never fill the pan more than one-third full with fat or oil.
3. Never leave oil or fat unattended during the heating or cooking period.
4. Do not try to fry too much food at a time, especially frozen food. This only lowers the temperature of the oil or fat too much, resulting in greasy food.
5. Always dry food thoroughly before frying, and lower it slowly into the hot oil or fat. Frozen foods, in particular, will cause frothing and spitting, if added too quickly.
6. Never heat fat, or fry, with a lid on the pan.
7. Keep the outside of the pan clean and free from streaks of oil or fat.
8. Never allow excessive splashing of oil onto the hob.

Safety requirements for deep fat frying

In the unfortunate event of a chip pan fire:

1. Switch **Off** the electricity supply.
NEVER attempt to move the pan - burns and injuries are caused almost invariably by picking up the burning pan and rushing outside with it.
2. Smother flames with a fire blanket or damp cloth.
NEVER use a fire extinguisher to put out a pan fire, as the force of the extinguisher is likely to tip the pan over.
NEVER use water to extinguish oil or fat fires.
When smothering the flames DO ENSURE that you FACE and ARMS are WELL PROTECTED from the flames to save you from becoming hurt.
3. After the fire has been extinguished LEAVE THE PAN TO COOL FOR AT LEAST 60 MINUTES BEFORE MOVING IT.
4. If you fail to put the fire out, call the fire brigade immediately.

SOLAR PLUS GRILL

CAUTION: Accessible parts may become hot when the grill is in use - children should be kept away.

Your cooker is not fitted with a conventional type of grill. The **solar plus** grill is designed to reduce your grilling times. It is quicker because it takes less time to warm up from cold. Conventional grills require 5 minutes pre-heat before food is placed beneath them, but for normal grilling the **solar plus** grill can be used from cold without any pre-heat. However, when toasting, optimum performance is achieved by preheating the grill for about 1 minute.

Note:

You will notice that the grill elements are protected by a wire mesh. This stops you from touching live parts.

DO NOT under any circumstances insert objects into the grill mesh as this could damage or break the element tubes OR if the grill is on cause an electric shock.

During use the mesh may become soiled. Do not attempt to clean it while the grill is still on. Turn the cooker off at the control unit and wait until it has cooled down before cleaning.

Care must be taken to ensure the grill mesh is not distorted

There are two halves to the grill, one on the left and one on the right. You can choose to have both sides on or just the left side on. Turning the control knob clockwise, will switch both sides on. Turning it anticlockwise, will only switch the left side on. The numbers which are displayed indicate the heat setting. Number **4** is the hottest and number **1** the coolest.

GRILLING SHOULD NOT BE UNDERTAKEN WITH THE GRILL/TOP OVEN DOOR CLOSED - This will cause overheating.

The grill will not operate unless the top oven control is in the '0' **Off** position.

Grilling procedure

1. Open the grill/top oven door fully.
2. Position the telescopic runners and grill pan as recommended for the food being cooked (see the 'Guide to Grilling' chart, next page).
3. Place the grill pan into the telescopic runners, position centrally under the element.
4. Never line the grill pan with aluminium foil as this may cause overheating of fat in the grill pan.

NOTE: As the grill pan will be hot when the grill is in use, ALWAYS use oven gloves when removing the grill pan.

SOLAR PLUS GRILL

Guide to grilling successfully

Food	Pre-heat	Shelf Position from base of oven	Setting	Approx. Cooking Time	Comments
Toasting of Bread Products	1 min.	3 or 2	Maximum	3-5 minutes. Grill pan and grid.	Always use the grill pan in conjunction with the telescopic runner and ensure it is located correctly.
Small cuts of meat – Sausages, Bacon	None	3 or 2	Maximum for 4 minutes, then reduce to 3	10-15 minutes. Grill pan and grid.	
Chops, etc. Gammon Steaks, Chicken pieces	None	2	Maximum for 6-8 minutes. reduce to 3-2½	25-30 minutes. Grill pan and grid.	
Fish Whole:	None	2	Maximum	6-8 minutes.	
Fillets:	None	3 or 2	Maximum	In base of grill pan.	
Fish in breadcrumbs	None	3 or 2	3	10-15 minutes. Grill pan and grid.	
Pre-cooked Potato Products	None	3 or 2	3	10-12 minutes.	
Pizzas	None	3 or 2	3	10-15 minutes. Grill pan and grid.	
Browning of Food	1 min.	2	Maximum	5-7 minutes. Dish placed directly on shelf.	

NOTE:

Position 1 is bottom runner from the base of the oven

TOP OVEN - CONVENTIONAL COOKING

The heat for conventional cooking in the top oven is provided by the grill element and the element under the floor of the oven. It is ideal for the slow cooking of cheaper cuts of meat in casseroles etc. but can also be used for small joints of meat up to 1.5kg (3lb).

The operation of the controls is covered on "The Controls".

See cooking charts for temperatures and shelf positioning.

The top oven can be used either independently to cook small quantities of food or in conjunction with the main oven to provide additional cooking space.

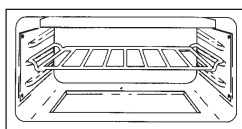

- The shelf should be positioned on the first or second runner from the bottom.

To use the oven proceed as follows:

- Set the top oven control to the required temperature, the top oven light will come on and wait for the thermostat light to go off, indicating that the oven has reached the right temperature.
- The food to be cooked should be placed in the centre of the shelf with a gap of at least 25mm (1in) between it and the grill element. This should avoid burning and ensure even cooking.
- **Do not place food or dishes on the floor of the oven.**

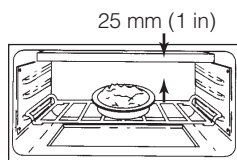

Platwarming in the top oven

Plates and dishes placed on shelf 1 of the top oven will be heated when the main oven is in use.

When the main oven is not in use, for instance when a meal is being cooked on the hob, place the plates and serving dishes on the shelf using the bottom runner and turn the top oven control to approximately 100°C. A maximum time of 10-12 minutes is all that is required to heat the plates and dishes.

NEVER operate the grill control when using the top oven for cooking or warming plates and dishes.

WARNING: DO NOT put delicate items china or items which could be affected by heat into the oven.

TOP OVEN TEMPERATURE CHARTS - MEAT

Meat	Pre-heat	Temperature °C	Time (approx.)	Position in Oven
Beef/ Lamb (slow roasting)	Yes	170/180	35 mins per 450g (1lb) + 35 mins over.	Runner 1 from bottom of oven.
Beef/ Lamb (foil covered)	Yes	190/200	35-40 mins per 450g (1lb)	
Pork (slow roasting)	Yes	170/180	40 mins per 450g (1lb) + 40 mins over	
Pork (foil covered)	Yes	190/200	40 mins per 450g (1lb)	
Veal (slow roasting)	Yes	170/180	40-45 mins per 450g (1lb) + 40 mins over	
Veal (foil covered)	Yes	190/200	40-45 mins per 450g (1lb)	
Poultry/Game (slow roasting)	Yes	170/180	25-30 mins per 450g (1lb) + 25 mins over	
Poultry/Game (foil covered)	Yes	190/200	25-30 mins per 450g (1lb)	
Casserole	Yes	150	2-2 1/2 hrs	

If using aluminium foil, never:

1. Allow foil to touch sides of oven.
2. Cover oven interior with foil.
3. Cover shelves with foil.

The most accurate method of testing the readiness of joints of meat or whole poultry is to insert a meat thermometer into the thickest part of a joint, or the thickest part of poultry thighs, during the cooking period. The meat thermometer will indicate when the required internal temp has been reached.

Beef - Rare: 60°C	Lamb: 80°C	Poultry: 90°C
Medium: 70°C	Pork: 80°C	
Well Done: 75°C	Veal: 75°C	

TOP OVEN TEMPERATURE CHARTS - BAKING

Food	Pre-heat	Temperature °C	Time in mins.	Position in Oven
Scones	Yes	210/220	10-15	Runner 2 from bottom of oven.
Small Cakes	Yes	180/190	20-25	Runner 2 from bottom of oven.
Victoria Sandwich	Yes	170/180	20-30	Runner 2 from bottom of oven.
Sponge Sandwich (fatless)	Yes	180/190	20-25	Runner 2 from bottom of oven.
Swiss Roll	Yes	200/210	10-15	Runner 2 from bottom of oven.
Semi-rich Fruit cakes	Yes	150/160	60-75 7 inch	Runner 1 from bottom of oven.
Rich Fruit cakes)	Yes	140/150	Time Dependent on size	Runner 1 from bottom of oven.
Shortcrust Pastry	Yes	190/200	Time Dependent on recipe	Runner 1 or 2 from bottom of oven.
Puff Pastry	Yes	200/210	Time Dependent on recipe	Runner 1 from bottom of oven.
Yorkshire Pudding	Yes	190/200	30-40	Runner 1 or 2 from bottom of oven.
Individual Yorkshire Puddings	Yes	200/210	20-30	Runner 2 from bottom of oven.
Milk Pudding	Yes	140/150	90-120	Runner 1 from bottom of oven.
Baked Custard	Yes	150/160	40-50	Runner 1 from bottom of oven.
Bread	Yes	200/210	30-45	Runner 1 from bottom of oven.
Meringues	Yes	100	150-180	Runner 2 from bottom of oven.

Note: If soft margarine is used for cake making, temperatures recommended by the manufacturers should be followed. Temperatures recommended in this chart refer to cakes made with block margarine only.

MAIN OVEN - THE PRECISION COOKING SYSTEM

The main oven of your new cooker is equipped with an intelligent electronic cooking system that gives you additional cooking performance, flexibility and features over traditional cooking products. The operation of the controls is covered on "the controls". See cooking charts for temperatures and shelf positioning.

Cooking temperature ranges

The intelligent cooking system will automatically suggest a suitable cooking temperature for several cooking modes. It is possible however to modify the suggested temperature within a range specific to each cooking mode.

User adjustable temperature ranges by cooking mode:			
Mode	Minimum	Back Left	Maximum
Fan oven	200°C	80°C	230°C
Roast meat	160°C	80°C	230°C
Roast chicken	190°C	80°C	230°C
Fish	180°C	80°C	230°C

Cook charts

All times and temperatures can be adjusted to suit personal taste. The information in the following charts is only a guide.

MAIN OVEN - THE PRECISION COOKING SYSTEM

COOK CHART - Fan oven mode: 			
Meat	Pre-heat	Temperature	Cooking Time
Beef	No	160/180°C	20-25 minutes per 450g (1lb) + 20 minutes extra
Lamb	No	160/180°C	25 minutes per 450g (1lb) + 25 minutes extra
Pork	No	160/180°C	25 minutes per 450g (1lb) + 25 minutes extra
Chicken/Turkey (up to 4kg/8lb)	No	160/180°C	18-20 minutes per 450g (1lb) + 20 minutes extra
Turkey (4-5.5kg/8-12lb)	No	150/160°C	12-14 minutes per 450g (1lb) + 15 minutes extra
Notes: Internal Temperatures:			
	Beef	rare	60°C
		medium	70°C
		well done	75°C
	Lamb		80°C
	Pork		80°C
	Poultry		90°C
BAKING	Preheat	Temperature	Cooking Time
Scones	yes	210/220°C	10-15 minutes
Small cakes	no	170/180°C	15-25 minutes
Victoria sandwich	no	160/170°C	20-30 minutes
Fatless sponge sandwich	yes	180/190°C	10-20 minutes
Swiss roll	yes	190/200°C	10-15 minutes
Semi rich fruit cake	no	140/145°C	60-75 minutes
Rich fruit cake	no	130/140°C	depending on size
Shortcrust pastry	no	190/200°C	depending on recipe
Puff pastry	no	190/200°C	depending on recipe
Yorkshire pudding	yes	180/190°C	30-45 minutes
Yorkshire pudding: Individual	yes	190/200°C	20-25 minutes
Bread	yes	200/210°C	30-45 minutes
Meringues	no	80/90°C	180-240 minutes
Notes: Use up to 2 shelves when cooking (ensure they are evenly spaced) It is not necessary to preheat the oven for some items.			



ECO program: this program can be used to cook meat. Use the 2nd shelf (starting from the bottom). Preheat for 15 minutes.

MAIN OVEN - THE PRECISION COOKING SYSTEM

COOK CHART - Roast Chicken mode: 				
Meat	Pre-heat	Temperature	Shelf Position	Cooking Time
Chicken	no	170°C	2 or 3	20 minutes per 450g (1lb)
Turkey	no	170°C	2 or 3	15-20 minutes per 450g (1lb)
Notes: Internal Temperatures:				
Poultry 90°C				
If the poultry is covered with foil, the cooking time will need to be extended.				

COOK CHART - Roast Meat mode: 				
Meat	Pre-heat	Temperature	Shelf Position	Cooking Time
Beef	no	170°C	2 or 3	20-25 minutes per 450g (1lb) + 20 minutes extra
Lamb	no	170°C	2 or 3	25 minutes per 450g (1lb) + 25 minutes extra
Pork	no	170°C	2 or 3	25 minutes per 450g (1lb) + 25 minutes extra
Notes: Internal Temperatures:				
Beef rare 60°C				
medium 70°C				
well done 75°C				
Lamb 80°C				
Pork 80°C				
If the meat is covered with foil, the cooking time will need to be extended..				

COOK CHART - Fish mode: 				
FISH	Pre-heat	Temperature	Shelf Position	Cooking Time
Fish steaks (open roasted)	yes	170°C	3	15-25 minutes
Whole fish (foil baked)	yes	180°C	2 or 3	20-25 minutes per 450g (1lb)
Whole stuffed fish (foil baked)	yes	180°C	2 or 3	25-30 minutes per 450g (1lb)

CARE AND CLEANING

WARNING: BEFORE CLEANING, SWITCH THE COOKER OFF AT THE MAINS COOKER CONTROL PANEL AND ALLOW IT TO COOL. IT IS ESSENTIAL THAT THE OVENS ARE CLEANED AND KEPT FREE FROM FATS, OIL AND GREASE.

- ! Never use steam cleaners or pressure cleaners on the appliance.
- ! Clean the glass part of the oven door using a sponge and a non-abrasive cleaning product, then dry thoroughly with a soft cloth. Do not use rough abrasive material or sharp metal scrapers as these could scratch the surface and cause the glass to crack.
- ! The accessories can be washed like everyday crockery (even in your dishwasher).

Cleaning of the Ceramic Hob

- Always** clean spills immediately. If the hob is reused before cleaning, spillage will be baked on and be very difficult to remove.
- Always** switch the cooker OFF at the cooker control panel.

To minimise cleaning:

- Always** take care and avoid spills.
- Always** use a Ceramic Hob Cleaner-Conditioner whenever cleaning is done. The Cleaner-Conditioner forms a protective film on the hob and contains a mild detergent which makes cleaning easier. Hotpoint has a Cleaner-Conditioner which can be obtained, either through a local Hotpoint Service Centre or retailer, part no.6004.

To clean off stubborn stains, the following can be used when the surface has cooled:

1. Cif, non-scratch cream cleaner.
2. Heavy soil can be removed from the surface by carefully using a glass scraper.
3. Hard water stains, grease spots and any discolouration having a metallic sheen can be removed with Solvol Autogol Super or any non abrasive stainless steel cleaner.

After cleaning, always use the Cleaner-Conditioner and finish it off by polishing with a clean, dry paper towel.

- Never** use abrasive or chemical oven cleaners as they can damage the surface of the hob.

The visual effect of any scratches which may occur in use can be minimised by the use of Cleaner-Conditioner. Such scratches cannot be removed but do not affect the function of the hob in any way.

'Heat Clean' Liners

'Heat Clean' liners are covered with a special enamel which absorbs cooking soils. At higher temperatures the soiling is slowly destroyed. In most cases normal cooking at higher temperatures will permit this cleaning to take place automatically.

However, if higher cooking temperatures are not used regularly then it may be necessary, in order to prevent heavy soiling, to run the oven at maximum temperature for at least two hours, from time to time.

The 'Heat Clean' liners can be washed in warm soapy water followed by rinsing in clear water. Dry well with a soft cloth.

NOTE: Do not use enzyme washing powder, harsh abrasives or chemical oven cleaners of any kind.

CARE AND CLEANING

WARNING: BEFORE CLEANING, SWITCH THE COOKER OFF AT THE MAINS COOKER CONTROL PANEL AND ALLOW IT TO COOL. IT IS ESSENTIAL THAT THE OVENS ARE CLEANED AND KEPT FREE FROM FATS, OIL AND GREASE.

Oven Fittings

The oven shelves can be cleaned either in a dishwasher or by using a fine steel wool soap pad. The grill and meat pans can be cleaned in warm soapy water using a fine steel wool soap pad to remove stubborn stains or in a dishwasher. They should be cleaned after each use.

Oven Interiors

To clean the oven interiors remove all the oven fittings and where applicable the 'Heat Clean' liners.

All types of oven cleaners can be used, but **do not** allow abrasive cleaners or oven spray to come into contact with the 'Heat Clean' liners.

Use a fine steel wool soap pad to remove stubborn stains.

Oven Door Cleaning

The inner door glass panel can be removed for easy cleaning, see "Care and Cleaning".

Cooker Exterior

The outside of the cooker should be cleaned regularly to keep it looking like new. Wipe over with a soft cloth wrung out in warm water and dry with a soft clean cloth. You can use mild non abrasive cleaners but always read the manufacturer's instructions first. Always test their suitability on a small area of the cooker not noticeable in normal use.

NOTE: DO NOT use scouring pads or abrasive cleaners as they may scratch the surface.

Wear protective gloves when cleaning any part of your cooker.

Door and Control Panel (Glass)

Regularly wipe with a clean, damp cloth and polish with a clean, dry cloth.

Door and Control Panel Trims (Stainless Steel)

Regularly wipe with a clean, damp cloth and polish with a clean, dry cloth.

Solar Plus Grill

To clean the solar plus grill, use a clean, damp, soapy cloth and wipe over. If stubborn stains remain, gently clean with a well soaped nylon scouring pad and wipe over with a damp cloth.

NOTE: DO NOT use metal cleaning utensils, wire wool or proprietary oven cleaners on the grill element mesh.

WARNING: TO AVOID ELECTRIC SHOCK, BEFORE REPLACING THE OVEN LIGHT, SWITCH THE COOKER OFF AT THE COOKER CONTROL UNIT (and allow to cool if the oven has been used).

Replacement of the Oven Light

Unscrew the glass cover, using a suitable cloth to protect the fingers and remove carefully. Unscrew the existing light bulb, and remove. Screw the new bulb into position and replace the glass cover, with metal washer, until positioned securely.

PLEASE PHONE US TO REGISTER YOUR APPLIANCE AND ACTIVATE YOUR PARTS GUARANTEE ON 08448 24 24 24

CARE AND CLEANING

CLEANING THE DOORS

Take particular care not to damage the inner surface of the door inner glass that is coated with a heat reflective layer. Do not use scouring pads, or abrasive powder, which will scratch the glass.

Ensure that the glass panel is not subjected to any sharp mechanical blows.

Stubborn stains can be removed by using a fine steel wool soap pad. For slight soiling the inner glass panel may be cleaned, while still warm, without removing it from the door. After cleaning, rinse and dry with a soft cloth.

SIDE OPENING DOORS

Cleaning the door glass is the same as the drop down doors, except take care to support the weight of the inner glass when removing and refitting.

DROP DOWN DOORS

Remove the door inner glass as follows.

1. Open the door fully and remove the extrusion end caps (This should be done by hand but if it proves too difficult, simply lift the inner glass to ease the end caps out of position).

NOTE: If you need to use a tool - be careful not to damage the extrusion or end cap.

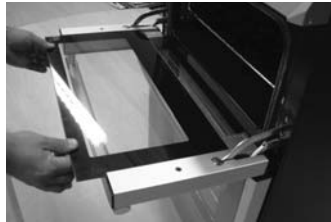

2. Carefully slide the inner glass towards you and withdraw it from its locating slots. Ensure that the door is not allowed to slam shut, due to the reduction in door weight. Clean the glass as described above.
3. The inside of the outer door glass can now be cleaned while still fitted to the cooker.

Refit the door inner glass as follows.

1. Open the door fully.
2. Locate the inner door glass into its slots, so that the printing is readable from the face nearest the oven in the closed position and the widest black band is towards the bottom of the door. The inner door glass has a special reflective coating on one side, in order to minimise surface temperatures and energy consumption during use, it is important it is fitted correctly.
3. Carefully slide the glass into its slots as far as it will go and replace the end caps.

NEVER OPERATE THE COOKER WITHOUT THE INNER DOOR GLASS IN POSITION.

SOMETHING WRONG WITH YOUR COOKER

Before contacting your nearest Service Centre/Installer, check the problem guide below; there may be nothing wrong with your cooker.

Problem	Check
Slight odour or small amount of smoke when grill / oven used first time	This is normal and should cease after a short period.
Nothing works	If you find that the timer display is blank, then it is likely that there is no electricity supply to your oven. Check: (i) That the main cooker wall is switched on (ii) Other appliances, to see if you have had a power cut (iii) The main circuit breaker for the property
Top oven, grill and main oven do not work.	Operating the cooker under the following conditions may cause a safety device to operate: (a) Grilling with the door closed - Always grill with the door fully open (b) Grilling for an excessively long period at maximum setting - see Grilling guide. Switch off appliance and allow to cool for approx 30 mins. Switch the cooker back on and check that the Grill, Top oven and Main Oven are now operating.
Grill keeps turning on and off	When the Grill control is operated, the Grill will cycle on and off, this is normal and <u>not</u> a fault.
Timer is flashing '0.00' 	The power supply to your oven has possibly been interrupted, but has now come back on again. Reset the timer to the correct time of day using the instructions given in the timer section of the book.
Oven temperatures too high or low	Check temperature and shelf positions are as recommended in the Oven Temperature Charts. It may be necessary to increase or decrease the recommended temperature slightly to suit your taste.
Oven does not cook evenly	Check: (a) Temperature and shelf positions are as recommended in the Oven Temperature Charts. (b) Oven utensils being used allow sufficient air flow around them.
Oven light does not work	The oven lamp is not covered by the guarantee. The part is easily changed (see the section 'Replacement of Oven Light'). A new light bulb may be obtained from our Parts department, see back page.
Draught from beneath control panel	A gentle flow of air will be blown from beneath the control panel when the appliance is used. If the appliance is still warm, this cooling fan may run on, or restart itself when all controls have been turned off. The fan will stop once the appliance has been cooled. This is normal and <u>not</u> a fault.
Steam / Condensation in the oven after use.	Steam is a by - product of cooking any food with a high water contact. To help minimise always: a) Try to avoid leaving food in the oven to cool after being cooked. b) Use a covered container, wherever possible.
The oven is not working and showing F01 to F68 code in the display	Your appliance has developed a fault which will require assistance from our service department.

Disposal of your product

To minimise the risk of injury to children please dispose of your product carefully and safely. Remove all doors and lids. Remove the mains cable (where fitted) by cutting off flush with the appliance and always ensure that no plug is left in a condition where it could be connected to the electricity supply.

To help the environment, Local Authority instructions should be followed for the disposal of your product.



Disposal of old electrical appliances

The European Directive 2002/96/EC on Waste Electrical and Electronic Equipment (WEEE), requires that old household electrical appliances must not be disposed of in the normal unsorted municipal waste stream. Old appliances must be collected separately in order to optimise the recovery and recycling of the materials they contain and reduce the impact on human health and the environment.

The crossed out "wheeled bin" symbol on the product reminds you of your obligation, that when you dispose of the appliance it must be separately collected.

Consumers should contact their local authority or retailer for information concerning the correct disposal of their old appliance.

Respecting and conserving the environment

Whenever possible, avoid pre-heating the oven and always try to fill it. Open the oven door as little as possible because heat is lost every time it is opened. To save a substantial amount of energy, simply switch off the oven 5 to 10 minutes before the end of your planned cooking time and use the heat the oven continues to generate.

Keep gaskets clean and tidy to prevent any door energy losses

If you have a timed tariff electricity contract, the "delay cooking" option will make it easier to save money by moving operation to cheaper time periods.

Make the most of your hot plate's residual heat by switching off cast iron hot plates 10 minutes before the end of your cooking time and glass ceramic hot plates 5 minutes before the end of cooking time.

The base of your pot or pan should cover the hot plate. If it is smaller, precious energy will be wasted and pots that boil over leave encrusted remains that can be difficult to remove.

Cook your food in closed pots or pans with well-fitting lids and use as little water as possible. Cooking with the lid off will greatly increase energy consumption

Use purely flat pots and pans

If you are cooking something that takes a long time, it's worth using a pressure cooker, which is twice as fast and saves a third of the energy.



Product Guarantee and Repair Information

Guarantee

12 Months Parts and Labour Guarantee

Your appliance has benefit of our manufacturer's guarantee, which covers the cost of breakdown repairs for twelve months from the date of purchase. This gives you the reassurance that if, within that time, your appliance is proven to be defective because of either workmanship or materials, we will, at our discretion, either repair or replace the appliance at no cost to you:

This guarantee is subject to the following conditions:

- The appliance has been installed and operated correctly and in accordance with our operating and maintenance instructions.
- The appliance is used only on the electricity or gas supply printed on the rating plate.
- The appliance has been used for normal domestic purposes only.
- The appliance has not been altered, serviced, maintained, dismantled, or otherwise interfered with by any person not authorised by us.
- Any repair work must be undertaken by us or our appointed agent.
- Any parts removed during repair work or any appliance that is replaced become our property.
- The appliance is used in the United Kingdom or Republic of Ireland.

The guarantee does not cover:

- Damage resulting from transportation, improper use, neglect or interference or as a result of improper installation.
- Replacement of any consumable item or accessory. These include but are not limited to: plugs, cables, batteries, light bulbs, fluorescent tubes and starters, covers and filters.
- Replacement of any removable parts made of glass or plastic.

THIS GUARANTEE WILL NOT APPLY IF THE APPLIANCE HAS BEEN USED IN COMMERCIAL OR NON-DOMESTIC PREMISES.

Recycling and Disposal Information

As part of Hotpoint's continued commitment to helping the environment, Hotpoint reserves the right to use quality, recycled components to keep down customer costs and minimise material wastage.

Please dispose of packaging and old appliances carefully. To minimise the risk of injury to children, remove the door, plug, and cut the mains cable off flush with the appliance. Dispose of these parts separately to ensure that the appliance can no longer be plugged into mains socket, and the door cannot be locked shut.

Repairs and After Sales

For product help and advice, repairs, spare parts or accessories, we're here to help.

For local repair engineers - **03448 111 606**

ROI - **0818 313 413**

UK standard local rate applies

ROI local Irish rate applies

For Parts and Accessories visit:

parts.hotpoint.co.uk/shop

Please remember to register your appliance at **www.hotpointservice.co.uk** to activate your 10 year parts guarantee.

Please note, our advisors will require the following information:

Model number:

Serial number:

PLEASE PHONE US TO REGISTER YOUR APPLIANCE AND ACTIVATE YOUR PARTS GUARANTEE ON 08448 24 24 24

Whirlpool EMEA S.p.A.
Via Carlo Pisacane n.1
20016 Pero (MI), Italy
VAT number: IT00693740425
www.hotpoint.co.uk



04/2018 - W11227792
XEROX FABRIANO

PLEASE PHONE US TO REGISTER YOUR APPLIANCE AND ACTIVATE YOUR PARTS GUARANTEE ON 08448 24 24 24