

BUSH

Instruction manual

BD1508A



You'll soon be enjoying your new DAB Alarm Clock Radio.

It all begins here, with your instructions. Don't worry, there's nothing too technical coming up. Just simple, step-by-step guidance to get you up and running quickly. Sound good? Then let's get started.

Help and Guidance

We're here to help you get the most from your DAB Alarm Clock Radio. Should you require any guidance, a simple solution can often be found online at:

www.bush-support.com

If you still require further assistance, call one of our experts on **0345 600 3021**.

Contents

1 Safety information

General safety information	8
Power source	8
Positioning the DAB Alarm Clock Radio	9
Moisture and water	9
Ventilation	9
Heat sources and flames	9

2 Getting to know your DAB Alarm Clock Radio

Your DAB Alarm Clock Radio	12
Connection	14
Initial set-up	14
Adjusting the volume	15
Time and date	15
Change the mode	16
USB charging socket	16

3 Using your DAB Alarm Clock Radio

Telescopic aerial	20
DAB Radio mode	20
Changing DAB stations	20
Scanning for DAB stations	20
Prune DAB stations	21
Storing a DAB station preset	21
Tune to a DAB preset station	22
DAB display information	22
Dynamic range control (DRC)	23

Contents

FM Radio mode	24
Telescopic aerial	24
Tuning to an FM station	24
Changing the Scan setting	25
Audio mode	25
Storing an FM station preset	26
Tune to an FM preset station	26
FM display information	27
Setting the alarm	27
Stop the Alarm	29
Snooze	29
Turn off the Alarm	29
Sleep timer	29
Cancel the Sleep timer	30
Display backlight timeout	30
Display language	31
4 Other information	
Software version	34
Factory reset	34
Technical specification	35
5 Product support	
Troubleshooting	38
Help and assistance	39
Disposal	40
Your Bush Guarantee	41

This page is left intentionally blank

If you require any technical guidance or find that your product is not operating as intended, a simple solution can often be found in the **Troubleshooting**

section of these instructions, or online at www.bush-support.com If you still require further assistance, call one of our experts on 0345 600 3021.

Safety information

1

This page is left intentionally blank

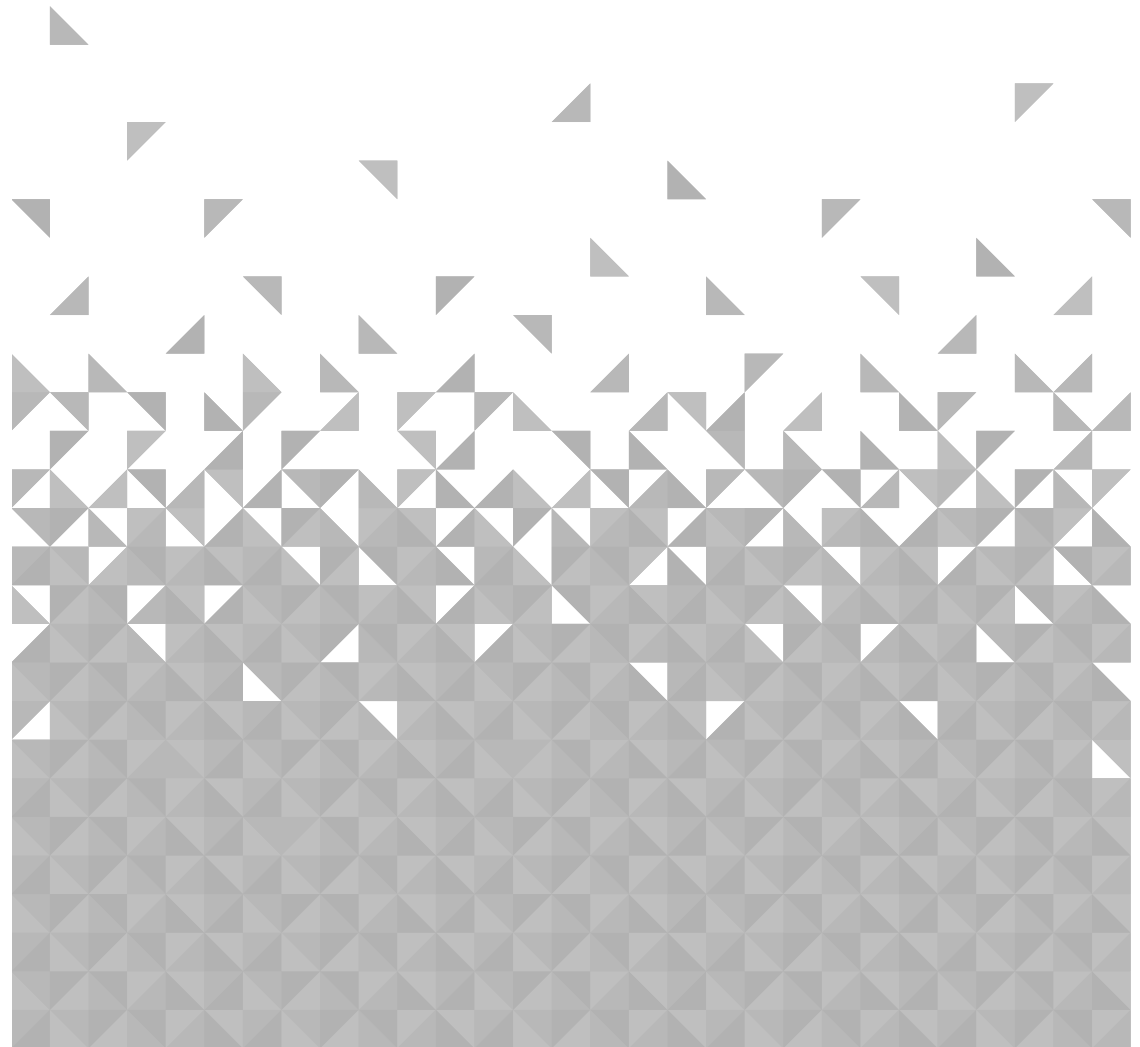

Safety information

Important - Please read these instructions fully before installing or operating

General safety information

Keep the product and all its parts out of reach of small children.

This product is not intended for use by persons (including children) with reduced physical, sensory or mental capabilities, or lack of experience and knowledge, unless they have been given supervision or instruction concerning the use of the appliance by a person responsible for their safety.

- **Do not** attempt to open the product. This product does not contain any user serviceable parts. Unauthorised handling of the device may damage it and will void your warranty.
- **Do not** use your Radio near emergency/intensive care medical equipment; if you have a pacemaker fitted or during an electrical storm.



To avoid possible hearing damage, do not listen to this radio at high volume levels for long periods of time. Always keep the volume within reasonable limits.

Power source

- Only use the power supply that came with the product. Using an unauthorised power supply will invalidate your guarantee and may irreversibly damage the product.
- Disconnect your Radio from the mains power supply during thunderstorms.
- Always check that you have completely switched off your Radio, before you change or disconnect the power supply.
- Where the mains power plug or an appliance coupler is used as the disconnect device, the disconnect device shall remain readily operable.
- If the Radio will not be used for a long period of time, make sure that the mains power is unplugged.

Safety information

Important - Please read these instructions fully before installing or operating

Positioning the DAB Alarm Clock Radio

It is important that you consider carefully in advance where your Radio will be situated and make sure that it is:

- on a flat and stable surface
- within 1.4 metres of a power socket. Please ensure that the mains power lead is not a trip hazard.
- at least 1 metre away from other electrical appliances to avoid interference
- where you can fully extend the telescopic aerial
- Never place your Radio directly onto antique or polished surfaces.

Moisture and water

- Keep it dry. Avoid exposure to precipitation, humidity and liquids which could all affect the product circuitry.
- **Do not** leave it in low temperatures as moisture can form inside the product, which may damage the circuit board.

Ventilation

- **Do not** block or cover slots, holes or openings on the product by placing on soft furnishings such as carpets, rugs or beds as these are provided for functionality and/or ventilation to ensure safe operation of the product

Heat sources and flames

- **Do not** leave it in high temperatures as electronic devices and plastic parts may warp in heat.
- Keep it away from bright sunlight or heat sources, such as a radiator.

If you require any technical guidance or find that your product is not operating as intended, a simple solution can often be found in the **Troubleshooting**

section of these instructions, or online at www.bush-support.com If you still require further assistance, call one of our experts on 0345 600 3021.

Getting to know your DAB Alarm Clock Radio

2

This page is left intentionally blank

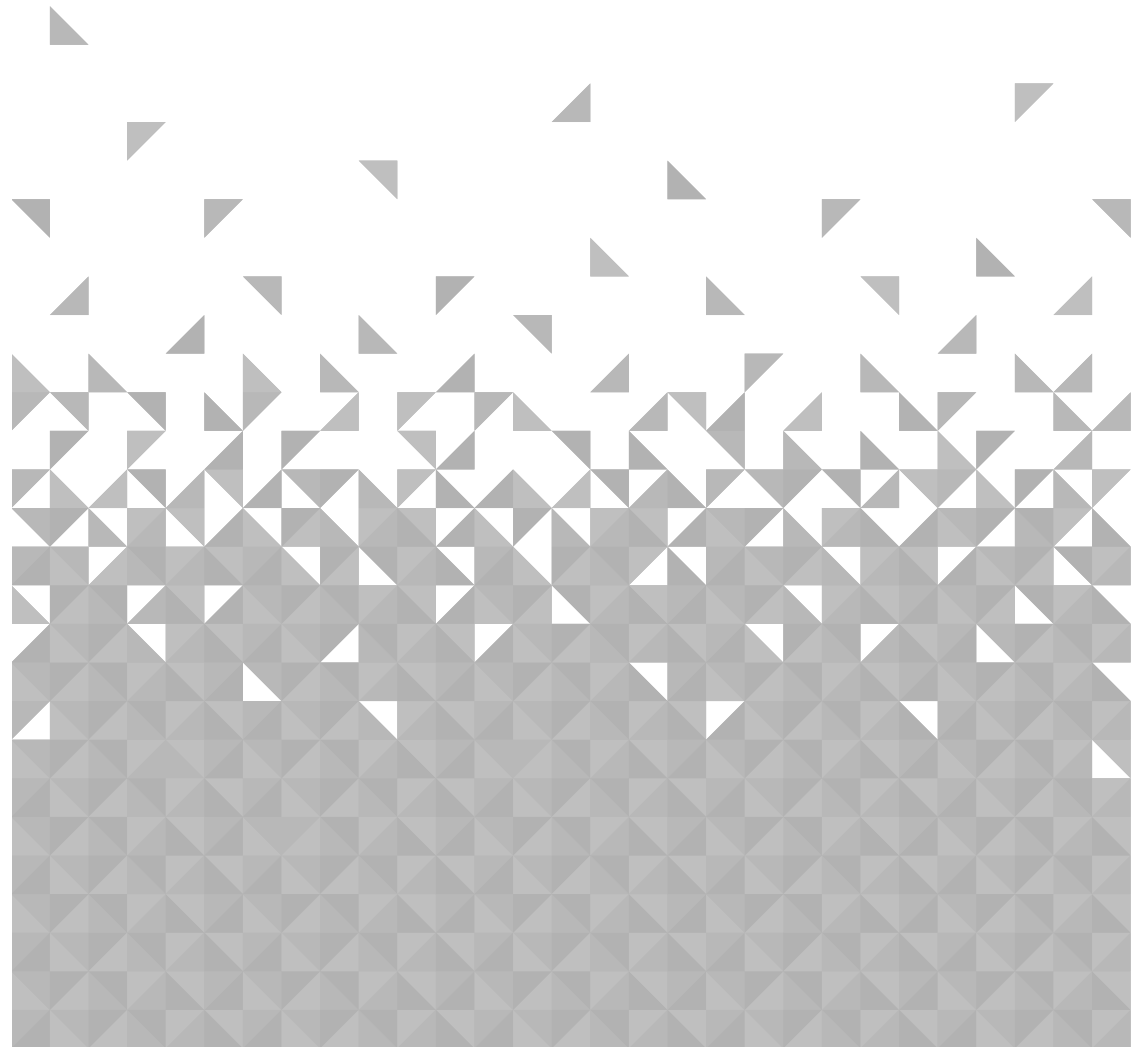

Getting to know your DAB Alarm Clock Radio

You'll be up and running in no time

Ready? Let's begin...

Please read these instructions carefully. They contain important information which will help you get the best from your product and ensure safe and correct installation and operation.

If you require any further assistance, our technical experts are happy to help. For full details, refer to the product support section at the end of these instructions.

Fig 1.

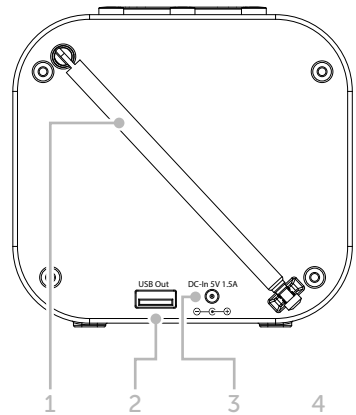

Fig 2.

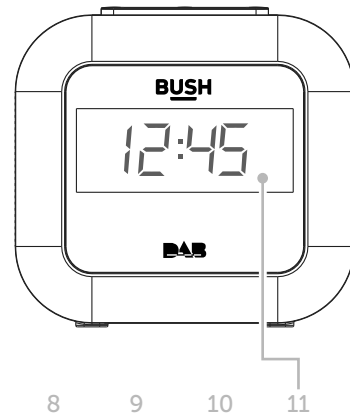
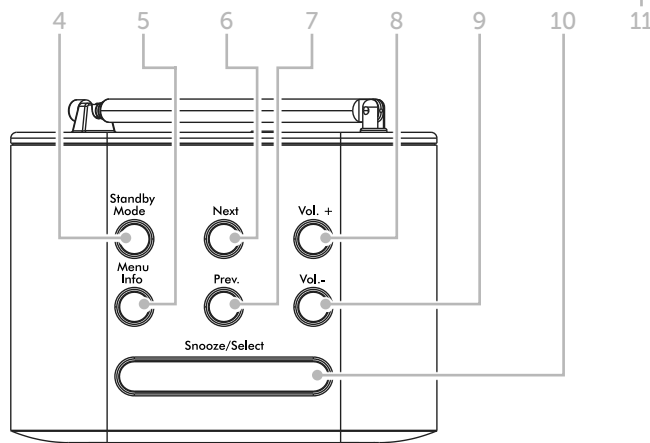

Fig 3.



Getting to know your DAB Alarm Clock Radio

You'll be up and running in no time

1. Telescopic aerial
2. USB charge socket (for mobile devices)
3. Power socket
4. Standby/Mode
 - Short press: Power on/Change the Mode
 - Long press: Standby
5. Menu/Info
 - Short press: Station information
 - Long press: Enter the Menu
 - In the menu: Short press to step back and exit the Menu.
6. Next
 - Short press:
 - In DAB mode: Move up the DAB station list
 - In FM mode: Move up the frequency band by 0.05MHz
 - In the Menu: Move through the Menu options
 - Long press:
 - In FM mode: Scan up the frequency band
7. Prev
 - Short press:
 - In DAB mode: Move down the DAB station list
 - In FM mode: Move down the frequency band by 0.05MHz
 - In the Menu: Move through the Menu options
 - Long press:
 - In FM mode: Scan down the frequency band
8. Vol. +
 - Increase the volume
 - Press and release in Standby mode to set the Alarm
9. Vol. -
 - Decrease the volume
 - Press and release in Standby mode to set the Clock Time
10. Snooze/Select
 - Press to Snooze when the alarm sounds
 - Press to Select a displayed radio station or menu option
11. Backlit display

If you require any technical guidance or find that your product is not operating as intended, a simple solution can often be found in the **Troubleshooting**

section of these instructions, or online at www.bush-support.com If you still require further assistance, call one of our experts on 0345 600 3021.

Getting to know your DAB Alarm Clock Radio

You'll be up and running in no time

Connection

1. Connect the mains power lead into the socket on the back of the Radio.
2. Plug the power adaptor into the mains power wall socket and switch on. The Radio will switch on, Welcome to Digital Radio will be displayed and then your Radio will go to Standby mode.

Initial set-up

1. Extend the telescopic aerial to ensure the maximum signal strength when you scan for radio stations.
2. Press and release the Standby button on the top of your radio. Your radio will switch on and begin an automatic scan for DAB stations. A progress bar will show the progress of the scan and the number of stations found during the scan will also be displayed.
3. When the scan is complete your radio will select the first available station and begin to play. Stations are listed in numerical and then alphabetical order by default.

Note: The DAB radio station list is stored in the memory and so the next time you switch your radio on, the station search does not take place. It is possible to scan manually for stations by pressing and releasing the Scan button.

4. Press and release the Prev or Next button, to scroll through the available stations in the station list.
5. When the station that you would like to listen is displayed, press and release the Select button. There will be a short delay whilst your radio tunes to your selected station.

Getting to know your DAB Alarm Clock Radio

You'll be up and running in no time

Adjusting the volume

Vol. +

- Press and release to increase the volume.
- Press and hold to progressively increase the volume.

Vol. –

- Press and release to decrease the volume.
- Press and hold to progressively decrease the volume.
Check the display, which will confirm the volume setting.

Time and date

The first time you listen to DAB radio, the time and date of your product will be synchronised automatically to that broadcast by the DAB service in 24 hour mode; which is in line with daylight saving, so there is no need to set the time and date manually.

If you do wish to set the time and date manually, you can press and release the Vol. – button in Standby mode to go directly to the time settings or you can turn on the radio and follow the steps below:

1. Press and hold the Menu/Info button to enter the menu options.
2. Press and release the Next button to scroll to <System>. Press and release the Select button.
3. Press and release the Next button to scroll to <Time>. Press and release the Select button. <Set Time/Date> is displayed. Press and release the Select button.
4. Set time is displayed and the hour digits will flash. Press and release the Prev or Next button to scroll to the correct hour. Press and release the Select button.

If you require any technical guidance or find that your product is not operating as intended, a simple solution can often be found in the **Troubleshooting**

section of these instructions, or online at www.bush-support.com If you still require further assistance, call one of our experts on 0345 600 3021.

Getting to know your DAB Alarm Clock Radio

You'll be up and running in no time

5. The minutes will now flash. Press and release the Prev or Next button to scroll to the correct minutes. Press and release the Select button. Set date is displayed and the day will flash. Use the Prev and Next buttons, together with the Select button, to select and confirm the day, month and year, using the same method as you used to set the time.

When you confirm the correct date, Time Saved is displayed and the display returns to <Set Time/Date>.

You can now use the Prev and Next buttons to scroll and the Select button to confirm, as you did to set the time and date to change the settings for:

- 12/24 hour clock display
- The date format, DD-MM-YYYY or MM-DD-YYYY
- To auto update the time from the DAB signal, FM signal, DAB or FM signal or no update.

Change the mode

Press and release the Standby/Mode button to change between DAB and FM modes. Please check the display, which will confirm the mode.

USB charging socket

You can charge mobile devices that have a USB charging cable, using the standard USB charging socket on the back of your DAB Alarm Clock Radio.

1. Connect the mobile device charging cable (not supplied) to your mobile device and plug the standard USB plug end into the standard USB socket of the back of the DAB Alarm Clock Radio.
2. Your DAB Alarm Clock radio will now charge your mobile device (check your mobile device display).

This page is left intentionally blank

Using your DAB Alarm Clock Radio

3

This page is left intentionally blank

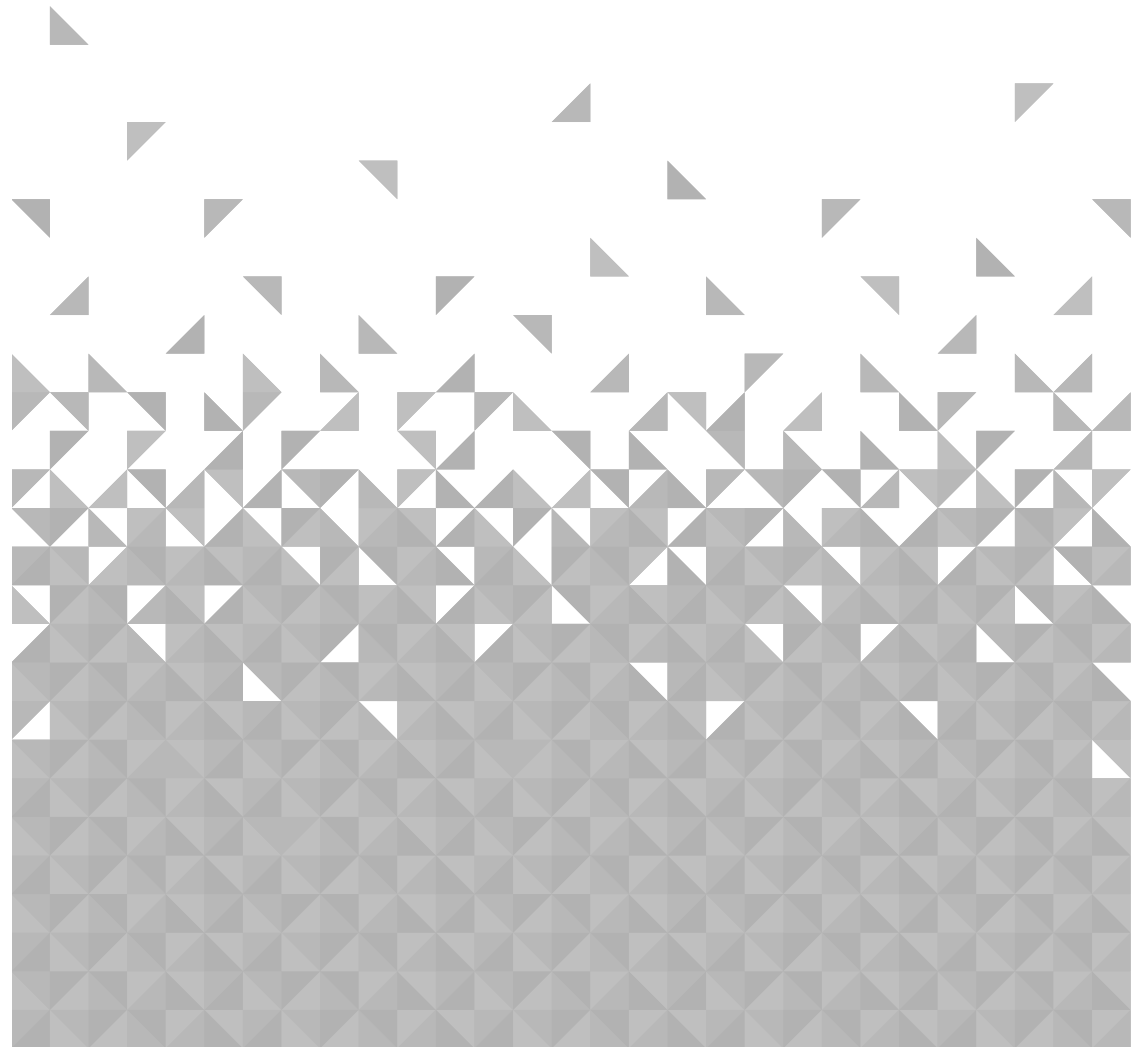

Using your DAB Alarm Clock Radio

Let's get started

Telescopic aerial

Please make sure that the aerial is fully extended before you attempt to tune to a DAB station (a vertical position is recommended). This will ensure that the maximum signal strength is available when the radio begins to scan. Extending the aerial also ensures the best possible sound quality.

DAB Radio mode

- Check that your Radio is in DAB mode. If you are not already in DAB mode, press and release the Mode button until you are in DAB mode (check the display).
- The first time you use the Radio or if the station list is empty, your radio will automatically begin to scan for DAB radio stations. A progress bar will show the progress of the scan and the number of stations found during the scan will also be displayed.
- If you were listening to a DAB station when you switched the radio off, then this station will automatically be selected when you switch the radio back on.

Changing DAB stations

1. Press and release the Next and Prev buttons to scroll through the available stations.
2. When the station that you would like to listen to is displayed, press and release the Select button to confirm. There will be a short delay whilst your radio tunes to your selected station.

Scanning for DAB stations

With DAB radio, additional stations and services regularly become available so it's a good idea to carry out a manual scan every now and then to make sure that you have the most up to date station listing stored within the memory of your Radio. If you have moved your Radio to another location, e.g.: if you go on holiday, then it's also a good idea to carry out a manual scan.

Using your DAB Alarm Clock Radio

Let's get started

In DAB mode:

1. Press and hold the Menu/Info button to enter the menu options.
2. Press and release the Next button until <Full scan> is displayed. Press and release the Select button.

The display will change to 'Scanning...'. A progress bar will show the progress of the scan and the number of stations found during the scan will also be displayed.

Prune DAB stations

You can remove the DAB stations in the station list that cannot be received in your area. These are listed with a '?' prefix.

In DAB mode:

1. Press and hold the Menu/Info button to enter the menu options.
2. Press and release the Next button to scroll to <Prune>. Press and release the Select button.
3. Prune? <No> Yes is displayed. Press and release the Prev button to scroll to <Yes>. Press and release the Select button to confirm and prune the station list. Stations with a '?' prefix will now no longer be displayed.

Storing a DAB station preset

Your Radio can store up to 10 DAB radio stations in its preset memories for instant access to your favourite stations.

Note: When you store DAB radio station presets, these do not overwrite your FM station presets.

1. Tune your radio to the station that you wish to preset.
2. Press and hold the Menu/Info button to enter the menu options. Press and release the Next button to scroll to <Preset Store>. Press and release the Select button.
3. Preset Store <1: (Empty) > is displayed if no previous station has been stored.

section of these instructions, or online at www.bush-support.com If you still require further assistance, call one of our experts on 0345 600 3021.

If you require any technical guidance or find that your product is not operating as intended, a simple solution can often be found in the **Troubleshooting**

Using your DAB Alarm Clock Radio

Let's get started

4. Press and release the Prev or Next button to scroll to the preset location that you would like to store the radio station to (1-10).
5. Press and release the Select button to confirm. Preset X stored, where 'X' is the number of the preset (1-10), will be displayed.

Note: If there is already an existing DAB station stored under a preset, it will be overwritten when you store the new station.

Tune to a DAB preset station

In DAB mode:

1. Press and hold the Menu/Info button to enter the menu options.
2. Press and release the Next button to scroll to <Preset Recall>. Press and release the Select button to confirm.
3. Preset Recall <1: > is displayed and the name or frequency of the station stored there, or (Empty) if no previous station has been stored.
4. Press and release the Prev or Next button to scroll to the preset location and station that you would like to listen to (1-10).
5. Press and release the Select button to confirm. The radio will instantly tune to that station and begin to play.

Note: If no DAB station has been stored under the preset button, Preset Empty will be displayed and the radio will revert to the previously selected radio station

DAB display information

When listening to a DAB station you can change the information that will appear on the display. There are several different types of information that are sent by the broadcaster.

- **Dynamic Label Segment (DLS)** - this is scrolling text information supplied by the broadcaster. Information could be the name of an artist or music title, DJ's name, contact details for the radio station etc.

Using your DAB Alarm Clock Radio

Let's get started

- **Signal Strength** - An empty will appear on the display to indicate the minimum signal strength for acceptable listening. The row of solid rectangles indicates the actual signal strength that you are receiving. The stronger the signal, the further to the right the row of solid rectangles will be.
 - **Program Type (PTY)** - such as 'Rock', 'Pop', 'Talk' or 'News'
 - **Multiplex Name** - displays the broadcasting area and collection of radio stations on this frequency e.g.: BBC National DAB, Digital 1 Network.
 - **Channel and Frequency** - e.g.: 12B 225.648 MHz
 - **Signal error** - This is displayed as a number between 0-99. It would not be possible to satisfactorily listen to a radio station with a signal error rate of 30 or above. Try adjusting the aerial or relocating your radio to improve reception.
 - **Signal information** - The data rate at which the signal is being transmitted.
 - **Time and date** - supplied by the broadcaster.
1. Repeatedly press and release the Menu/Info button to cycle through the different information options.

Dynamic range control (DRC)

In DAB mode:

The dynamic range for each radio programme is set by the broadcaster for each radio station and may be different for the types of programme broadcast, such as pop or classical music or a chat show. The dynamic range control signal is transmitted in parallel with the audio signal for each programme and with your radio you can use this control signal to expand or compress the dynamic range (the difference between the loudest and quietest sounds) of the reproduced audio signal. Changing the dynamic range can affect the 'loudness' and/or 'quality of sound' of the programme that you hear so that it will be more suited to your listening conditions and your own personal listening requirements. e.g. in a noisy environment, where quiet sounds might be swamped, setting the compression to maximum will 'boost' the quiet sounds, whilst keeping the loudest sounds at their original level.

section of these instructions, or online at www.bush-support.com If you still require further assistance, call one of our experts on 0345 600 3021.

If you require any technical guidance or find that your product is not operating as intended, a simple solution can often be found in the **Troubleshooting**

Using your DAB Alarm Clock Radio

Let's get started

There are 3 levels of compression:

- **DRC off** - no compression. This is the default setting.
- **DRC low** - medium compression.
- **DRC high** - maximum compression.

Press and hold the Menu/Info button to enter the menu options.

2. Press and release the Next button to scroll to <DRC>. Press and release the Select button.

Note: the current DRC setting will have an '*' in the display.

3. Press and release the Next button to scroll through the options and press and release the Select button to confirm.

FM Radio mode

- If you are not already in FM mode, press and release the Mode button to go to FM mode (check the display).
- If you were listening to an FM station when you switched the Radio off then this station will be automatically selected when you switch the Radio back on.

Telescopic aerial

Please make sure that the aerial is fully extended before you attempt to tune to a FM station (a vertical position is recommended). This will ensure that the maximum signal strength is available when the radio begins to scan. Extending the aerial also ensures the best possible sound quality.

Tuning to an FM station

- Press and hold the Next button to scan up the frequency band.
- Press and hold the Prev button to scan down the frequency band.
- Press and release the Next or Prev button to fine tune each frequency in 0.05MHz steps.

If you require any technical guidance or find that your product is not operating as intended, a simple solution can often be found in the **Troubleshooting**

Using your DAB Alarm Clock Radio

Let's get started

Note: If reception is still poor try moving the radio to another location.

Changing the Scan setting

In FM mode:

1. Press and hold the Menu/Info button to enter the menu options.
2. Press and release the Next button until FM <Scan setting> is displayed. Press and release the Select button. The current Scan setting will have an '*' in the display.

There are two different options to choose from:

- **Strong stations** - The scan will only stop when a strong signal strength is received which should also result in a better audio quality. It is possible that the station you are scanning for may be missed using this option.
 - **All stations** - The scan will stop for every station it receives, even if the signal strength is poor.
3. Press and release the Next button to choose from the two options available and press and release the Select button to confirm.

Audio mode

The radio will automatically switch between Stereo and Mono, depending on the quality of the signal being received but you can override this function and manually switch between Stereo and Mono.

1. Press and hold the Menu/Info button to enter the menu options.
2. Press and release the Next button to scroll to <Audio setting>. Press and release the Select button.

There are now two different options of <Forced mono> and <Stereo allowed> and the current setting will have an '*' display.

3. Press and release the Next button to choose from the two options available. Press and release the Select button to confirm.

section of these instructions, or online at www.bush-support.com If you still require further assistance, call one of our experts on 0345 600 3021.

Using your DAB Alarm Clock Radio

Let's get started

Storing an FM station preset

Your radio can store up to 10 FM stations in its preset memories for instant access to your favourite stations.

Note: When you store FM radio station presets, these do not overwrite your DAB station presets.

1. Tune your radio to the station that you wish to preset.
2. Press and hold the Menu/Info button to enter the menu options. Press and release the Next button to scroll to <Preset Store>. Press and release the Select button.
3. Preset Store <1: (Empty) > is displayed if no previous station has been stored.
4. Press and release the Prev or Next button to scroll to the preset location that you would like to store the radio station to (1-10).
5. Press and release the Select button to confirm. Preset X stored, where 'X' is the number of the preset (1-10), will be displayed.

Note: If there is already an existing FM station stored under a preset, it will be overwritten when you store the new station.

Tune to an FM preset station

In FM mode:

1. Press and hold the Menu/Info button to enter the menu options.
2. Press and release the Next button to scroll to <Preset Recall>. Press and release the Select button to confirm.
3. Preset Recall <1: > is displayed and the name or frequency of the station stored there, or (Empty) if no previous station has been stored.
4. Press and release the Prev or Next button to scroll to the preset location and station that you would like to listen to (1-10).
5. Press and release the Select button to confirm. The radio will tune to that station and begin to play.

Using your DAB Alarm Clock Radio

Let's get started

Note: If no FM station has been stored under the preset button, Preset Empty will be displayed and the radio will revert to the previously selected radio station

FM display information

When listening to an FM station you can change the information that will appear on the second line of the display.

Radiotext (RT) - This is scrolling text information supplied by the broadcaster. Information could be the name of an artist or music title, DJ's name, contact details for the radio station etc.

Program Type (PTY) - Such as 'Rock', 'Pop', 'Talk' or 'News'

Station name or frequency - Such as BBC R4 or 93.30MHz

Audio mode - Stereo or Mono

Time and date - Supplied by the broadcaster.

1. Repeatedly press and release the Menu/Info button to cycle through the different information options.

Setting the alarm

Note: Check that the radio has the correct time and date before you set an alarm.

You can press and release the Vol. + button in Standby mode to go directly to the alarm settings (one press Alarm 1, two presses Alarm 2), or you can turn on the radio and follow the steps below.

1. Press and hold the Menu/Info button to enter the menu options.
2. Press and release the Next button to scroll to <System>. Press and release the Select button.
3. Press and release the Next button to scroll to <Alarm>. Press and release the Select button.

section of these instructions, or online at www.bush-support.com If you still require further assistance, call one of our experts on 0345 600 3021.

Using your DAB Alarm Clock Radio

Let's get started

- Alarm 1 Setup is displayed (Press and release the Vol.+ button to set Alarm 2). Press and release the Select button.
- Alarm 1 Wizard On time is displayed and the hour digits for the alarm will flash.
- Press and release the Prev or Next buttons to scroll to the hour for the alarm and press and release the Select button.
- The minutes will now flash. Press and release the Prev or Next buttons scroll to the minutes for the alarm and press and release the Select button. The duration time will now flash.
- Press and release the Next button to scroll to the duration for the alarm. You can choose from 15, 30, 45, 60, 90 and 120 minutes. Press and release the Select button. The source for the alarm will now flash.
- Press and release the Next button to scroll to the sound source for the alarm. You can choose from Buzzer, DAB or FM. Press and release the Select button.

Note: If you select DAB or FM radio for the alarm source, 'Last listened' will flash in the display. Press and release the Select button and the last listened to radio station in DAB or FM, as appropriate, will be used for your alarm.

- Press and release the Next button to scroll to the frequency for the alarm. You can choose from Daily, Once, Weekends or Weekdays. Press and release the Select button.

Note: If you select 'Once', you will then be prompted to set the date for your alarm.

- Press and release the Prev or Next buttons to set the volume for your alarm. Press and release the Select button.

Note: Remember to set the alarm radio volume to one that will wake you. You will not be able to set the volume for less than 5 bars for this reason. When the alarm sounds, the volume will increase progressively until it reaches the alarm volume that you have set.

Using your DAB Alarm Clock Radio

Let's get started

- Alarm 1 Wizard is displayed again, together with Alarm Off (or On). Press and release the Next button to choose Alarm On or Off and press and release the Select button to confirm. Alarm Saved is displayed.
- An alarm clock symbol will appear in the radio display to confirm that an alarm has been set.

Note: If the time is not set or has failed to update from the radio signal, Time is not set will be displayed when you try to set the alarm. The radio will then prompt you to set the time. An alarm can only be set after the time has been set.

Stop the Alarm

When the alarm sounds, press and release any button apart from the Snooze button, Alarm off will be displayed. Alternatively, you can press and release the Snooze button (see Snooze function below).

Note: When you press a button to stop the alarm, the alarm symbol will remain in the display and the alarm will sound again at the same time the next day, unless it was set for 'Once' only.

Snooze

When the alarm sounds you can press and release the Snooze button. Snooze will be displayed, followed by the snooze time countdown from 9 minutes, until the alarm sounds again.

Turn off the Alarm

Follow the steps for 'Setting an Alarm' and select 'Off' in step 12.

Sleep timer

You can set your radio to switch to Standby mode automatically using the sleep timer. You can choose from Sleep off, 15, 30, 45, 60 and 90 minutes.

section of these instructions, or online at www.bush-support.com If you still require further assistance, call one of our experts on 0345 600 3021.

If you require any technical guidance or find that your product is not operating as intended, a simple solution can often be found in the **Troubleshooting**

Using your DAB Alarm Clock Radio

Let's get started

With your radio switched on (not in Standby mode):

1. Press and hold the Menu/Info button to enter the menu options.
2. Press and release the Next button to scroll to <System>. Press and release the Select button.
3. Press and release the Next button to scroll to <Sleep>. Press and release the Select button.
4. Press and release the Next button to scroll through the available options. Stop when the sleep time you would like is displayed and press and release the Select button. <Sleep> will be displayed.
5. Your radio will countdown and switch to Standby mode automatically after the minutes you have selected, have elapsed.

Cancel the Sleep timer

With your radio switched on (not in Standby mode):

1. Press and hold the Menu/Info button to enter the menu options.
2. Press and release the Next button to scroll to <System>. Press and release the Select button.
3. Press and release the Next button to scroll to <Sleep>. Press and release the Select button.
4. Press and release the Next button until Sleep off is displayed. Press and release the Select button. <Sleep> will be displayed.

Display backlight timeout

You can adjust the display backlight timeout. Options of permanently On, 10, 20, 30, 45, 60, 90, 120, and 180 seconds are available. The current setting will have an '*' in the display.

With your radio switched on (not in Standby mode):

1. Press and hold the Menu/Info button to enter the menu options.

Using your DAB Alarm Clock Radio

Let's get started

2. Press and release the Next button to scroll to <System>. Press and release the Select button.
3. Press and release the Next button to scroll to <Backlight>. Press and release the Select button.
4. <Timeout> is displayed. Press and release the Select button. Press and release the Next button to scroll through the available backlight timeout options of On, 10, 20, 30, 45, 60, 90, 120 or 180 seconds. Stop when the backlight timeout you would like is displayed and press and release the Select button. <Timeout> will be displayed.

You can now press and release the Prev and Next buttons to scroll and the Select button to confirm, as you did to set the Backlight timeout, to change the settings for the backlight brightness for the <Dim level> and <On level>. There are 3 options available, High, Medium and Low.

Display language

You can change the display language of your radio, there are 4 options available; English, French, German and Italian. An '*' will be displayed next to the current setting.

With your radio switched on (not in Standby mode):

1. Press and hold the Menu/Info button to enter the menu options
2. Press and release the Next button to scroll to <System>. Press and release the Select button.
3. Press and release the Next button to scroll to <Language>. Press and release the Select button.
4. Press and release the Next button to scroll to the language you would like. Press and release the Select button to confirm.

Other information

4

This page is left intentionally blank

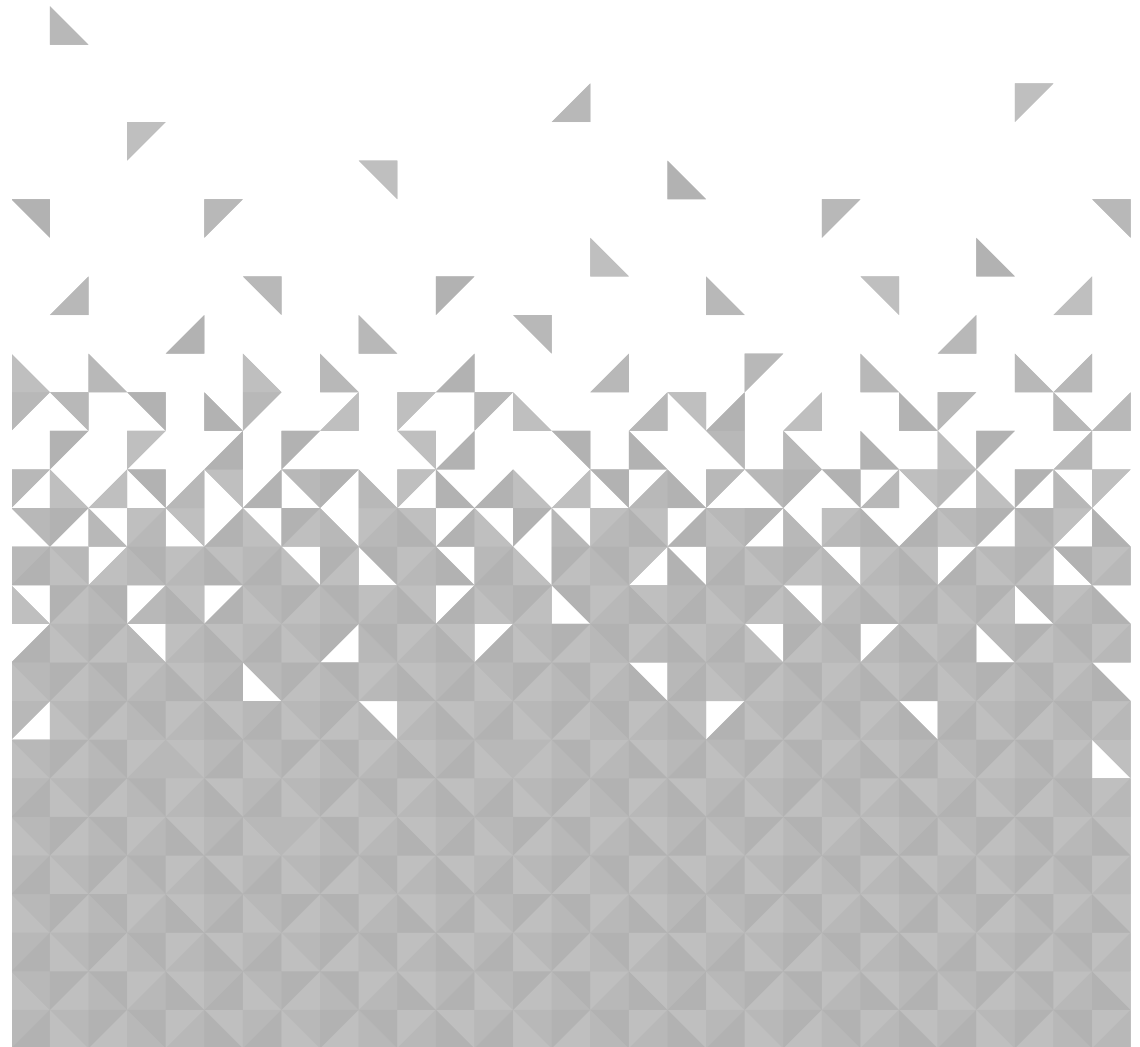

Other information

Helpful technical information

Software version

You can check the software version of your radio.

With your radio switched on (not in Standby mode):

1. Press and hold the Menu/Info button to enter the menu options
2. Press and release the Next button to scroll to <System>. Press and release the Select button.
3. Press and release the Next button to scroll to <SW Version>. Press and release the Select button.

The software version will be displayed and you may wish to make a note of it here:

.....

Factory reset

You can reset your radio and restore all of the original factory settings.

Note: If you reset your radio all of your stored station presets will be deleted.

With your radio switched on (not in Standby mode):

1. Press and hold the Menu/Info button to enter the menu options
2. Press and release the Next button to scroll to <System>. Press and release the Select button.
3. Press and release the Next button to scroll to <Factory reset>. Press and release the Select button. Factory Reset? <No> Yes will be displayed.
4. Press and release the Prev button to scroll to <Yes>. Press and release the Select button.

Other information

Helpful technical information

5. Restarting... will be displayed. After a few seconds the display will change to Welcome to Digital Radio and will then go to Standby mode. When you next power on your radio from Standby mode, it will begin an automatic scan for DAB stations. A progress bar will show the progress of the scan and the number of stations found during the scan will also be displayed. When the scan is complete your radio will select the first available station and begin to play. Stations are listed in numerical and then alphabetical order by default.

Technical specification

Power adaptor:	Output DC 5V 1.5A Input AC 100-240V/50Hz
USB Socket:	Output 5V 1A
Audio output:	1.2W RMS
Frequency range:	
DAB:	Band III, 174 MHz to 240 MHz
FM:	87.5 MHz to 108 MHz

Product support 5

This page is left intentionally blank

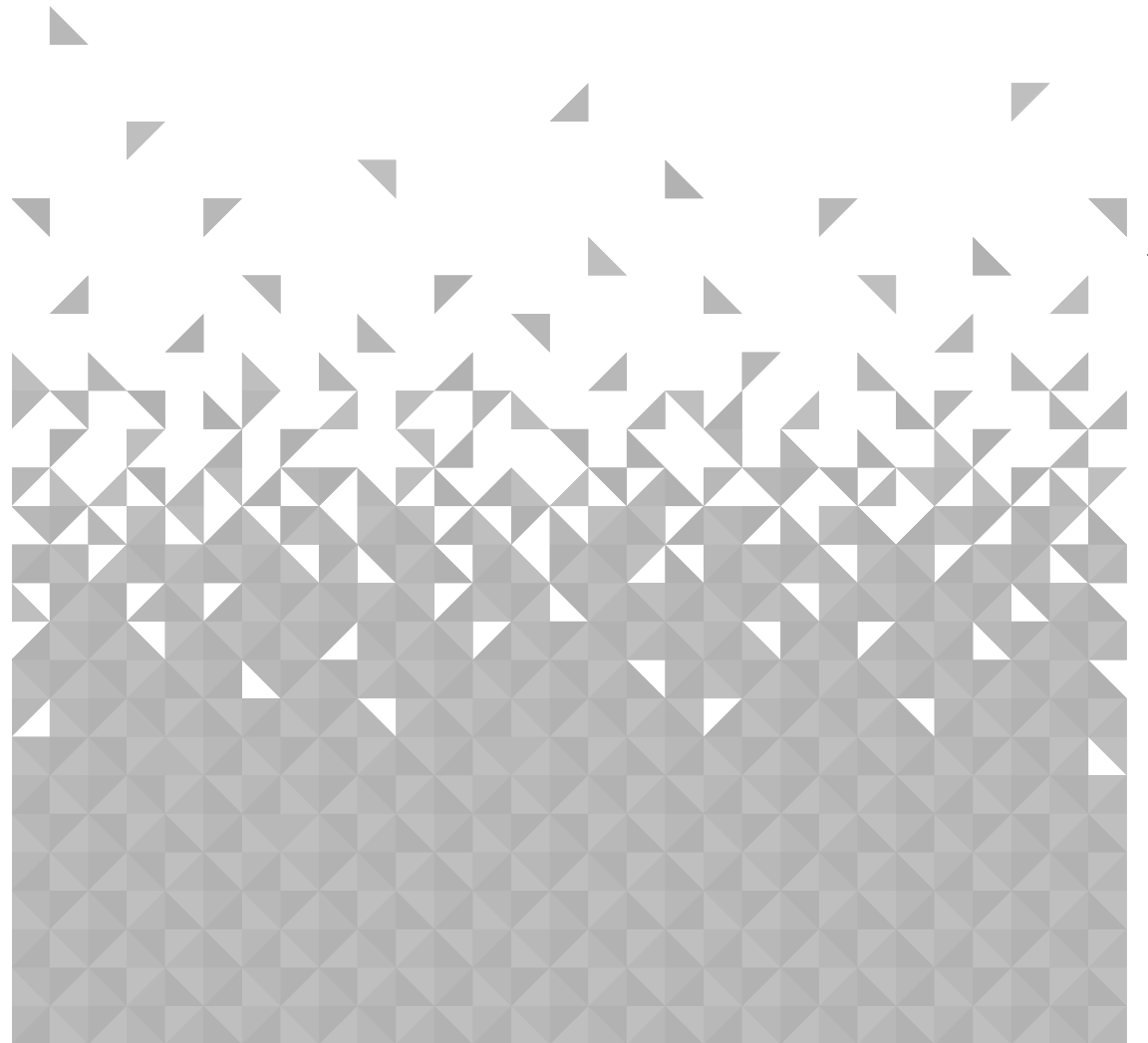

Product support

Help is always at hand

Troubleshooting

No sound / power:

- Adjust the volume.
- Check that the mains power wall socket is switched on and that your radio is not in Standby mode.

Radio reception is poor:

- Make sure that you have fully extended the telescopic aerial.
- Rescan for radio stations, see pages 20 and 24.
- Try moving your radio to another location to see if reception improves.
- Check that you do not have other electrical equipment too close to your Radio, causing interference.
- Visit www.digitalradionow.com for information about DAB reception in your area.

The function buttons do not respond:

- Check that the mains power lead is connected at the back of your radio and the mains power wall socket is switched on. Press and release the Standby button.
- Unplug the mains power. Leave the radio for 3 minutes and then reconnect the power.
- Try a reset to factory defaults. See page 34.

Note: All of your settings, including the radio station list and any presets will be deleted when you reset the Radio.

Product support

Help is always at hand

Help and assistance

If you require any technical guidance or find that your DAB Alarm Clock Radio is not operating as intended, a simple solution can often be found in the **Troubleshooting** section of these instructions or online at www.bush-support.com.

If you still require further assistance, call one of our experts on **0345 600 3021***. To help give us give you a fast and efficient service please have the following information ready:

Model Ref.

Serial number

Date of purchase

You can find these on the rating plate - a small information panel (usually a sticker or metal plate) on the rear or bae of your product.

This will be shown on your receipt

Local call rates applies*

Lines open 8am-7pm Monday to Saturday and 10am-4pm Sunday.

*Calls to Bush enquiry lines may attract a charge and set up fee from residential lines depending on your call plan/tariff. Mobile and other providers costs may vary, see www.bt.com/pricing for details.

For security and training purposes, telephone calls to and from customer service centres may be recorded and monitored. Calls from Republic of Ireland will attract international call charges.

If you require any technical guidance or find that your product is not operating as intended, a simple solution can often be found in the **Troubleshooting**

section of these instructions, or online at www.bush-support.com If you still require further assistance, call one of our experts on 0345 600 3021.

Product support

Help is always at hand

Disposal



This product should not be treated as normal household waste and it should be recycled. Please take it to your nearest collection facility or for further details contact your local council or visit www.recycle-more.co.uk.



This product is intended for use within the UK. This equipment complies with the essential requirements of the Radio Equipment Directive 2014/53/EU.

Declaration of Conformance

Hereby, Argos Ltd, declares that this DAB Alarm Clock Radio BD1508A is in compliance with the essential requirements and other relevant provisions of the Radio Equipment Directive 2014/53/EU. The complete declaration of conformity can be obtained by contacting <http://www.bush-support.com/>

Product support

Help is always at hand

BUSH

Call us now and register your 12 month guarantee

Thank you for choosing Bush. Your new product is guaranteed against faults and breakdowns for 12 months. Don't forget to register it with us today so we can provide you with our best possible after-sales service and useful updates.

www.bushregistration.co.uk

FREEPHONE*

0800 597 8548

Lines are open 8am - 8pm, 365 days a year. *Calls may be recorded and monitored.

Your Bush Guarantee

This product is guaranteed for twelve months from the date of original purchase. Any defect that arises due to faulty materials or workmanship will be repaired free of charge (or if applicable the product will be replaced or the purchase price refunded) where possible during this period by the dealer from who your purchased the unit.

The guarantee is subject to the following provisions:

- The guarantee does not cover accidental damage, misuse, cabinet parts, knobs or consumable items.
- The product must be correctly installed and operated in accordance with the instructions contained in the manual.
- It must be used solely for domestic purposes. The guarantee will be rendered invalid if the product is re-sold or has been damaged by inexpert repair.
- Specifications are subject to change without notice.
- Bush disclaim any liability for loss or damage arising from the breakdown of the product.
- This guarantee is in addition to and does not diminish your statutory or legal rights.

Important Data Protection Information

If you provide us with information about another person, you confirm that they have appointed you to act for them, to consent to the processing of their personal data including sensitive personal data and that you have informed them of our identity and the purposes (as set out in the Important Data Privacy notice displayed overleaf) for which their personal data will be processed.

You are entitled to ask for a copy of the information we hold about you (for which we may charge a small fee) and to have any inaccuracies in your information corrected.

For quality control and training purposes, we may monitor or record your communications with us.

If your personal details change, if you change your mind about any of your marketing preferences or if you have any queries about how we use your information, please let us know by contacting our Data Protection Officer, Domestic & General, Leicester House 17 Leicester Street, Bedworth, Warwickshire CV12 8JP.

Guarantor: Argos Limited - 489 - 499 Avebury Blvd. - Milton Keynes - MK9 2NW

section of these instructions, or online at www.bush-support.com If you still require further assistance, call one of our experts on 0345 600 3021.

If you require any technical guidance or find that your product is not operating as intended, a simple solution can often be found in the **Troubleshooting**



This page is left intentionally blank

This page is left intentionally blank



BUSH

Contact:

www.bush-support.com

Helpline: 0345 600 3021

 DAB Digital
Radio