

# BUSH

## Instruction manual

BUSH Built-in Fan Oven  
LSBCHP  
LSBGHP



### 技术要求:

- 1.材质：铜版纸，材质符合ROHS标准，每平方米105g；
- 2.尺寸：A4大小；
- 3.整本说明书彩印，印刷字迹清晰明了。
- 4.颜色以电子档为准，图为说明书封面。

						名称	英国ARGOS 商标BUSH F51IX LSBCHP说明书			图号	FSMS-ARGOS-01-001	
						品号	40300200679			材料	铜版纸	
标记	处数	分区	更改文件号	签名	年月日	阶段标记	数量	比例				
设计		2018.10.15	标准化						1	浙江安德电器有限公司		
校对												
审核												
工艺			批准			共	1	张	第	1	张	

# BUSH

## Instruction manual

BUSH Built-in Fan Oven

LSBCHP

LSBGHP



You'll soon be enjoying your new Built-in Oven

It all begins here, with your instructions. Don't worry, there's nothing too technical coming up. Just simple, step-by-step guidance to get you up and running quickly. Sound good? Then let's get started.

## Help and Guidance

We're here to help you get the most from your Built-in Oven. Should you require any guidance, a simple solution can often be found online at:

**[www.bush-support.com](http://www.bush-support.com)**

If you still require further assistance, call one of our experts on **01759 487838**.

# Contents

## 1 Safety information

Safety information 6

## 2 Getting to know your Built-in Oven

Ready? Let's begin 10

Accessories 12

## 3 Installing your Built-in Oven

Cabinet installation 14

Electrical Connection 15

## 4 Using your Built-in Oven

Controls 20

Oven functions Programming 21

General oven and Cooking tips 22

## 5 Care and Maintenance

Cleaning 24

Replacing the lamps 25

Technical specification 26

## 6 Product support 29

Troubleshooting 31

Help and assistance 32

Declaration of conformance to product standards 33

Disposal 33

Guarantee 34



# Safety information

1





## Safety information

**Important** - Please read these instructions fully before installing or operating

### INSTALLATION WARNINGS

**IMPORTANT:** Prior to Installation ensure that the local supply conditions (electricity voltage and frequency) are compatible with the requirements of your built-in oven.

**IMPORTANT:** Carefully unpack and examine the appliance for any damage. If you think there is a defect, do not use the appliance and contact BUSH Product Support on 01759 487838. Packaging materials should be collected together and disposed of immediately as they may be harmful to children.

**IMPORTANT:** Keep the electrical cable (not supplied) of your built-in oven away from the hot areas of your appliance, do not let the cable touch the appliance. Keep the cable away from sharp edges and heated surfaces.

**IMPORTANT:** Ensure that the electric supply cable is not trapped or damaged during installation.

**IMPORTANT:** In the event that the cable connecting your built-in oven becomes damaged, it must be replaced by a suitably qualified person. This cable must not be replaced by an unauthorised person.

**IMPORTANT:** Protect your built-in oven against atmospheric effects. Do not expose your oven to effects such as sun, rain, snow etc.

**IMPORTANT:** The materials surrounding the appliance (cabinets) must be able to withstand a minimum temperature of 100°C.

**IMPORTANT:** When using your oven for the first time your built-in oven may give off an unusual odour from the heating elements and insulation materials. This is normal for cooking appliances. To eliminate this odour run the oven at 250 degrees for 40-60 mins with the oven empty.

**WARNING:** Before obtaining access to terminals, all supply circuits must be disconnected.

### DURING USAGE

**IMPORTANT:** This appliance can be used by children aged from 8 years and above and persons with reduced physical, sensory or mental capabilities or lack of experience and knowledge if they have been given supervision or instruction concerning use of the appliance in a safe way and understand the hazards involved. Children shall not play with the appliance. Cleaning and user maintenance shall not be made by children without supervision.

**WARNING:** The appliance and its accessible parts become hot during use. Care should be taken to avoid touching heating elements. Children less than 8 years of age shall be kept away unless continuously supervised.

**WARNING:** NEVER try to extinguish a cooking fire with water. Instead switch off the appliance and cover flame e.g. with a lid or a fire blanket.

**CAUTION:** Do not allow children in the kitchen when cooking or after, as the parts may still be hot. Many parts of the oven will become hot and present a considerable hazard to children.

**CAUTION:** When the oven is hot never touch the oven glass by hand or with tools.

**CAUTION:** Before starting to use your appliance, ensure curtains, paper or flammable items are kept away from your appliance. Do not keep flammable materials inside of or around your oven.

**CAUTION:** Take care when closing the oven door that there is nothing obstructing it from closing as this may break the glass door.

**IMPORTANT:** When using the grill the oven door must be kept closed.



## Safety information

**Important** - Please read these instructions fully before installing or operating

**IMPORTANT:** Make sure the oven control knobs are all in the off position when not in use.

**IMPORTANT:** If you do not intend to use your built-in oven for a long period of time turn off the electric supply to the oven.

### GENERAL SAFETY WARNINGS

**IMPORTANT:** This appliance has been designed for non-professional, domestic use only. Do not use this oven for commercial use or any other application e.g. room heating.

**WARNING:** Danger of fire: do not store flammable items on or near the cooking surfaces or inside the oven.

**IMPORTANT:** Do not try to lift or move this appliance by pulling on the door handle.

**WARNING:** Ensure that the appliance is switched off before replacing the lamp to avoid the possibility of electric shock.

**IMPORTANT:** Your appliance is produced in accordance with all applicable local and international standards and regulations.

**IMPORTANT:** Maintenance and repair work must only be performed by authorised service technicians. Installation and repair work that is carried out by unauthorised technicians is dangerous and could invalidate your guarantee.

**IMPORTANT:** When the door of the oven is open, do not hang or lean anything on it. You may unbalance your appliance or damage the door or door hinges.

**IMPORTANT:** Do not hang towels, dishcloths or clothes from the built-in oven or its handles.

### CLEANING AND MAINTENANCE

**IMPORTANT:** Always turn the appliance off before operations such as cleaning or maintenance. You can do this by switching the built-in oven off using cooker isolation switch.

**IMPORTANT:** Do not remove the control knobs to clean the control panel.

**WARNING:** Do not use harsh abrasive cleaners or sharp metal scrapers to clean the oven door glass since they can scratch the surface, which may result in shattering of the glass.

TO MAINTAIN THE EFFICIENCY AND SAFETY OF YOUR APPLIANCE, WE RECOMMEND YOU ALWAYS USE OUR AUTHORISED SERVICE AGENTS AND ORIGINAL SPARE PARTS.

**FOR ASSISTANCE CALL BUSH PRODUCT SUPPORT 01759 487838.**





# Getting to know your Built-in Oven

# 2





# Getting to know your Built-in Oven

You'll be up and running in no time

## Ready? Let's begin...

Please read these instructions carefully. They contain important information which will help you get the best from your Built-in Oven and ensure safe and correct installation and operation.

If you require any further assistance, our technical experts are happy to help. For full details, refer to the product support section at the end of these instructions.

# Getting to know your Built-in Oven

You'll be up and running in no time

## Built-in Oven Accessories

1. 1 x Baking tray
2. 1 x Grill insert
3. 1 x Grill pan handle
4. 1 x Chrome shelf
5. 1 x User Manual
6. 1 x Fixing kit

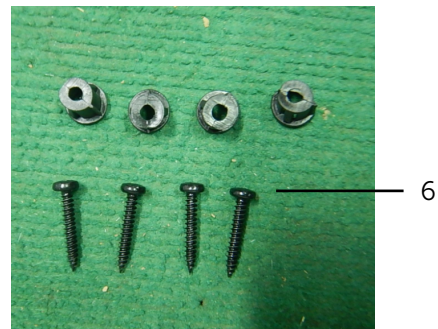
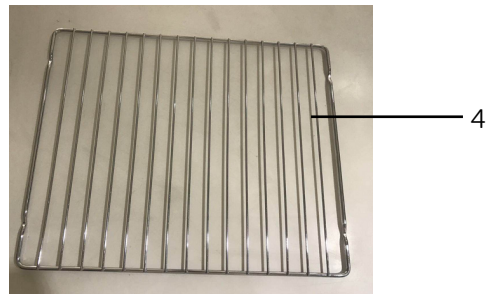
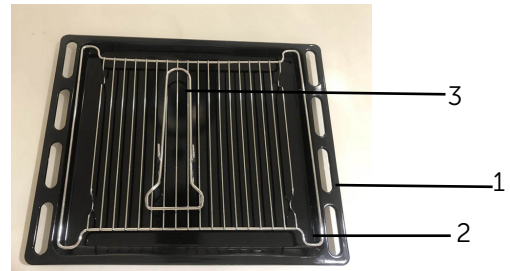

## Tools needed for installation



Cross head screwdriver



Electric drill



Pencil

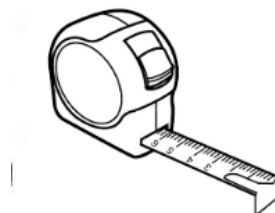

Tape measure

If you require any technical guidance or find that your product is not operating as intended, a simple solution can often be found in the **Troubleshooting** section of these instructions,

**Installing your  
Built-in Oven**

**3**



# Installing your Built-in Oven

Bringing it all together

## Installation

**This appliance should be installed by a competent person or qualified electrician in accordance with the regulations in force (All relevant British Standard/ Codes of Practice/relevant Building/IET regulations) and in a well ventilated space. Please read instructions before installing and using this appliance.**

Important: - The power supply to the appliance must be cut off before any adjustments or maintenance work is carried out.

### Installation of Built-in Ovens

In order to ensure that the built-in appliance functions properly, the cabinet containing it must be appropriate. The figure below gives the dimensions of the cut-out for installation under the counter or in a wall cabinet unit.

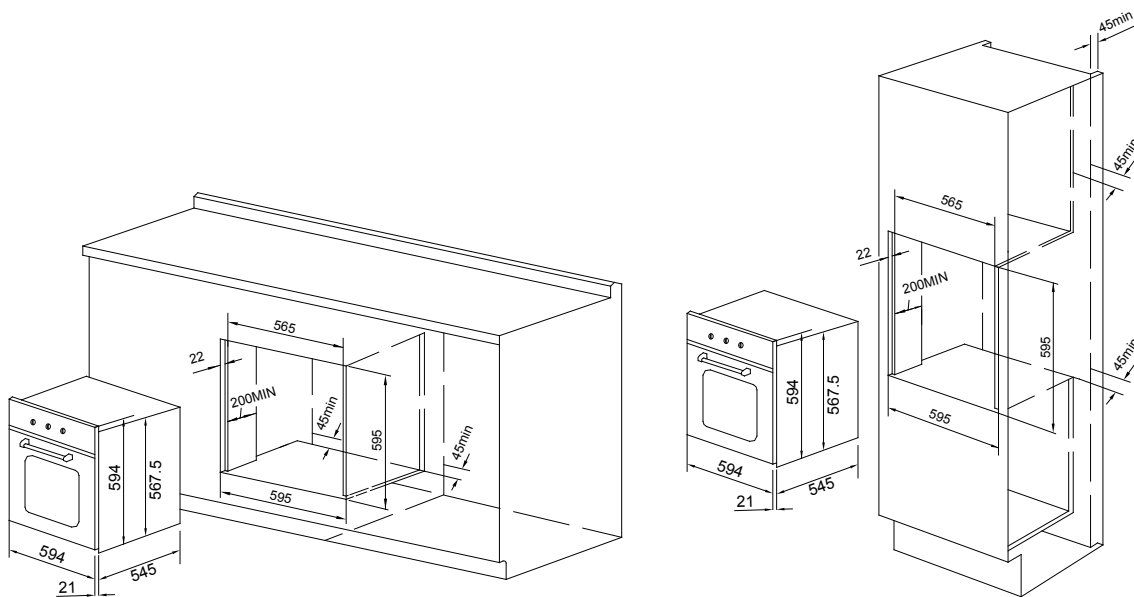

The worktop and any associated hob should be fitted **BEFORE** installing this oven.

It is recommended that if installing a built-in oven directly under the hob then there should be a minimum air gap of 20 mm between the oven and the bottom of the hob. Failure to maintain a suitable clearance may impair the performance of the hob.

Ensure that air can flow freely around the housing area. If the oven is being installed into a fully enclosed built-under oven housing unit it may be necessary to cut a small slot in the top of the plinth fitted under the unit. Cut a section 400 mm wide and a minimum of 15mm high to allow air to pass under the unit. Alternatively cut a section 400 x450mm in the base of the carcass.

Failure to allow adequate ventilation to the appliance may result in overheating or damage to adjacent units and could invalidate the guarantee.

Surfaces of furniture and walls adjacent to the appliance should be heat, splash and steam resistant. All cabinet doors must be at least 4mm from the oven at all points.

Certain types of vinyl or laminate kitchen furniture are particularly prone to heat damage and discolouration. We cannot accept responsibility for damage caused by normal use of the appliance to any material that de-laminates or discolours at temperatures less than 65°C above room temperature.

When placing the oven in the housing, do not use the oven door or handle as a lever for lifting the oven as damage may result.

If you lower the oven door, you will see 4 screw holes, 2 on each side of the oven. The oven should then be secured to the housing by fitting screws into these holes.

If you require any technical guidance or find that your product is not operating as intended, a simple solution can often be found in the **Troubleshooting** section of these instructions.

# Installing your Built-in Oven

## Bringing it all together

### Provision for Ventilation

The appliance housing used must provide adequate ventilation.

For built-in installation, a minimum ventilation space of 85 – 90mm 40mm must exist between the rear of the appliance and the back of the housing or an adjacent wall.

If a tall housing is to be installed flush with the ceiling, a 20cm<sup>2</sup> ventilation cut-out must be provided at the top of the housing.

### Electrical Connection

This appliance must be installed by a qualified electrician to comply with the relevant Institution of Engineering and Technology (I.E.T.) regulations and also the local electricity supply company requirements.

This appliance must not be connected to an ordinary domestic power point.  
The mains terminal is situated on the back of the oven.

- **GREEN AND YELLOW = EARTH**
- **BLUE = NEUTRAL**
- **BROWN = LIVE.**

As the colours of the wires in the mains lead for the appliance may not correspond with the coloured markings identifying the terminals in your spur box, proceed as follows:

1. The wire which is coloured green and yellow must be connected to the terminal marked E (Earth) or coloured Green.
2. The wire which is coloured blue must be connected to the terminal marked N (Neutral) or coloured Black.
3. The wire which is coloured brown must be connected to the terminal marked L (Live) or coloured Red.

Connect the cable to the correct terminals. Check that the links are correctly fitted and that the terminal screws are tight. Secure the mains cable using the cable clamp. Ensure the cable route avoids the risk of trapping or touching hot surfaces.



# Installing your Built-in Oven

Bringing it all together

## Fitting on a Power Supply Cable

Opening the terminal board:

- Using a screwdriver ,prize the bolt on the side tabs of the terminal board cover ;
- Unscrew the bolt, pull open the cover of the terminal board .

To install the cable, proceed as follows:

- Remove the wire clamp screw and the three contact screws L-N -  $\perp$
- Fasten the wires beneath the screw heads using the following color scheme :Blue (N) Brown (L) Yellow-Green  $\perp$
- Fasten the supply cable in place with the clamp and close the cover of the terminal board .

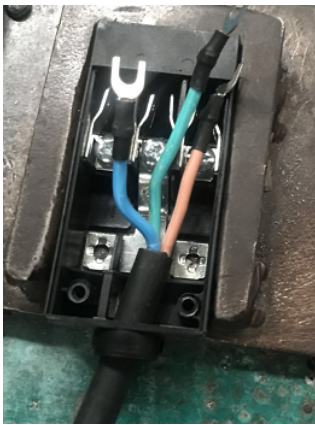
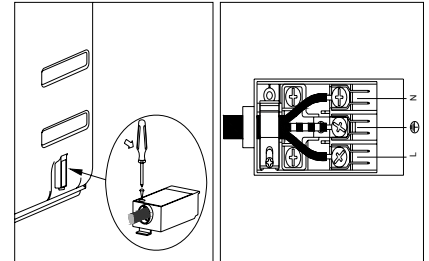

Put the supply cable into the terminal board



Fasten the wires beneath the screw heads



Fasten the supply cable in place with the clamp

If you require any technical guidance or find that your product is not operating as intended, a simple solution can often be found in the **Troubleshooting** section of these instructions.

# Using your Built-in Oven



# Using your Built-in Oven

## Getting started

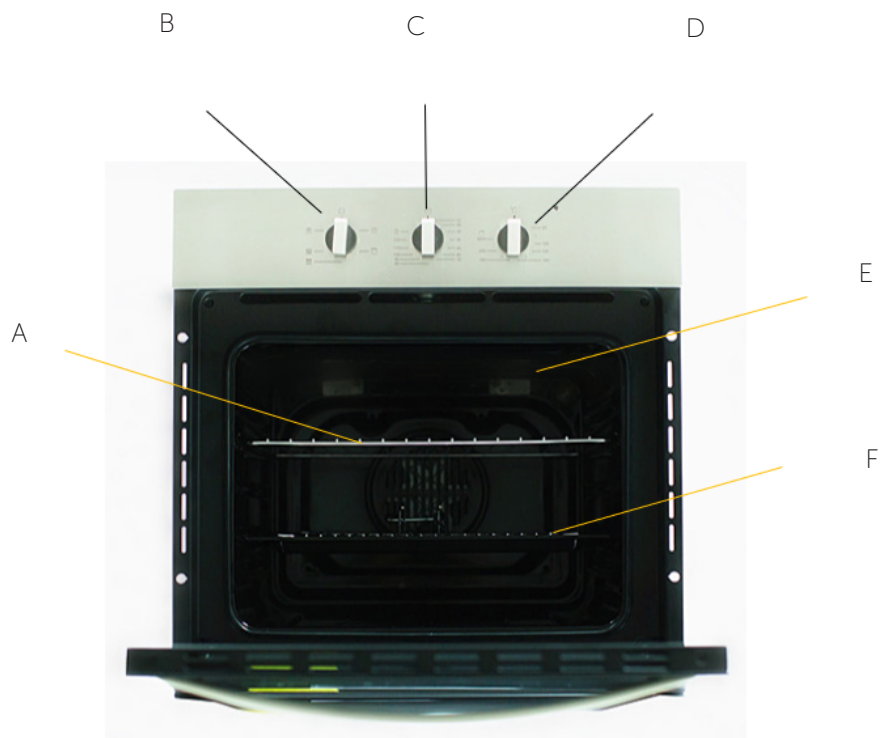

- A. Chrome wire shelf
- B. 5 Function mode control knob
- C. Mechanical minute minder
- D. Temperature control knob
- E. Oven lamp
- F. Baking tray

If you require any technical guidance or find that your product is not operating as intended, a simple solution can often be found in the **Troubleshooting** section of these instructions,

# Using your Built-in Oven

## Getting the most from your appliance

### Oven functions



Oven light



Grill



Fan assisted grill



Fan oven



Defrost

**Oven light**-The oven light will operate on all oven functions

**Grill**-The top central heating elements comes on .The extremely high and direct temperature of the grill makes it possible to brown the surface of meats and roasts while locking the juices in to keep them tender. The grill is also highly recommended for dishes that require a high temperature on the surface: beef steaks, veal, rib steak, fillets, hamburgers etc.

**Fan assisted grill**-The top central heating elements and the fan come on. This combination of features increases the effectiveness of the unidirectional thermal radiation of the heating elements through forced circulation of the air throughout the oven. This helps prevent food from burning on the surface, allowing the heat to penetrate right into the food. Excellent results are achieved with kebabs made with meats and vegetables, sausages, ribs lamb chops, chicken in a spicy sauce, quail, pork chops, etc.

**Fan oven**-When set to Fan oven mode, the fan element and the fan operate providing a delicate heat distributed uniformly throughout the oven. This mode is ideal for baking and cooking delicate foods on multiple shelves, especially cakes that Swiss rolls and small portions of vegetables, etc.

**Defrost**-When set to 'Defrost' mode, the fan located at the back of the oven circulates room temperature air around the food. This is recommended for the defrosting of all types of food, but in particular for delicate types of food which do not require heat, for example: ice cream cakes, cream or custard desserts, fruit cakes, etc. By using 'Defrost' mode, the defrosting time is approximately halved. In the case of meat, fish and bread, it is possible to accelerate the process by selecting 'Multi Cooking mode' and setting the temperature between 0°C to 100°C.

### Using your appliance for the first time

The first time you use your appliance, we recommend that you set the temperature setting to the highest mark. Set the cooking mode selection knob to a cooking mode and leave the oven on for about half an hour with nothing in it and the oven door shut. Then, open the oven door and allow the oven to cool. Any odour that may be detected during this initial use is due to the evaporation of substances used to protect the oven during storage.

# General oven and cooking tips

## General Oven Tips

The wire shelves should always be pushed firmly to the back of the oven.

Baking trays with food cooking on them should be placed level with the front edge of the oven's wire shelves. Other containers should be placed centrally. Keep all trays and containers away from the back of the oven, as over-browning of the food may occur.

For even browning, the maximum recommended size of a baking tray is 340 mm (13½") by 340 mm (13½").

When the oven is on, do not leave the door open for longer than necessary, otherwise the knobs may get very hot.

- Always leave a "finger's width" between dishes on the same shelf. This allows the heat to circulate freely around them.
- To reduce fat splashing when you add vegetables to hot fat around a roast, dry them thoroughly or brush lightly with cooking oil.
- Where dishes may boil and spill over during cooking, place them on a baking tray.

## Using the Grill

This multi-function oven has 2 different grilling modes.

Use the '**Grill**' mode with the oven door closed, place the food on the center of the grill pan, insert and fit the grill pan on either the 3rd or 4th shelf from the bottom. Note: only the central part of the top heating element operates for grilling.

When using 'Grill' mode, we recommend you set the temperature to the highest setting. However, this does not mean you cannot use lower temperatures, simply adjust the knob to the desired temperature.

Use '**Fan assisted grill**' mode with the oven door closed. This mode is very useful for grilling foods rapidly, as the distribution of heat by the fan makes it possible not only to brown the surface, but also to cook the bottom of the food. It can also be used for browning foods at the end of the cooking process, such as adding that gratin finish to pasta bakes for example.

When using 'Fan assisted grill' mode, place the food on the 2nd or 3rd oven shelf from the bottom, then place a dripping-pan on the 1st rack from the bottom to prevent fat and grease from dripping onto the oven floor. We recommend you set the temperature to 200°C, as it is the most efficient temperature for 'Fan assisted grill' mode. However, this does not mean you cannot use lower temperatures, simply adjust the knob to the desired temperature.

**Important:** for best results and to save energy, always use the 'Fan assisted grill' with the oven door closed.

## General oven and cooking tips

### Baking cakes

When baking cakes, always place them in a preheated oven. Make sure you wait until the oven has been preheated thoroughly (the indicator light will turn off). To prevent heat loss and the cake from dropping, do not open the oven door during baking.

In general...

... if pastry is too dry

Increase the temperature by 10°C and reduce the cooking time.

... if pastry has dropped

Use less liquid or lower the temperature by 10°C.

... if pastry is too dark on top

Place it on a lower shelf, lower the temperature, and increase the cooking time.

... if cooked well on the inside but sticky on the outside

Use less liquid, lower the temperature, and increase the cooking time.

... if the pastry sticks to the pan

Grease the pan well and sprinkle it with a dusting of flour or use greaseproof paper.

... if I used multi shelf cooking and one shelf is more cooked

Use a lower temperature setting next time. It is not necessary to remove the food from all the racks at the same time.

### Cooking pizza -Suggested cooking function

For best results when cooking pizza:

- Preheat the oven for at least 10 minutes.
- Use a light aluminum pizza pan, placing it on the shelf supplied with the oven. Don't use the dripping pan since this will extend the cooking time, making it difficult to get a crispy crust.
- Do not open the oven door frequently while the pizza is cooking;
- If the pizza has a lot of toppings (three or four), we recommend you add the mozzarella cheese on top halfway through the cooking process.
- For best results, only use one shelf at a time, but if you want to cook on two shelves, use the 2nd and 4th racks from the bottom with a temperature of 220°C and swap them halfway through cooking.

## General oven and cooking tips

Cooking fish and meat-Suggested cooking function 

When cooking white meat, fowl and fish, use a temperature setting from 180°C to 200°C.

For red meat that you want well done on the outside while tender and juicy in the inside, it is best to start with a high temperature setting

(200°C-220°C) for a short time, then turn the oven down afterwards.

In general, the larger the roast, the lower the temperature setting. Place the meat on the centre of the shelf and place the dripping pan beneath it to catch the fat.

Make sure that the shelf is inserted so that it is in the centre of the oven. If you would like to increase the amount of heat from below, use a lower shelf height. For savoury roasts (especially duck and wild game), dress the meat with lard or bacon on the top.

# Care and maintenance

5





# Care and maintenance

## Looking after your appliance

### Cleaning

**WARNING!** Isolate the power supply to the appliance and make sure that the oven is cool.

Before cleaning your oven or performing maintenance, make sure that the cooking mode selection knob and the cooking temperature selection knob is set to 'OFF'. To extend the life of your oven, it must be cleaned frequently.

The inside of the oven should preferably be cleaned immediately after use, when it is still warm (but not hot), with warm water and soap. The soap should be rinsed away and the interior dried thoroughly. Avoid using abrasive detergents, scourers, acidic cleaners such as lime scale remover, etc, as these could damage the enamel, and can result in development of rust and corrosion. If stains are particularly tough to remove, use cleaners specifically recommended to clean ovens and follow the instructions provided with the cleaner.

**Never use steam cleaner for cleaning inside the oven.**

Do not clean using caustic creams, abrasive cleaning powders, thick wire wool or hard tools. Enamelled parts of the oven can be damaged if excess cleaning liquids are not immediately removed. After cleaning the interior parts of the oven with a soapy cloth, rinse it and then dry thoroughly with a soft cloth. Clean the glass surfaces with special glass cleaning agents.

**Never** use flammable agents like acid, thinner or petrol when cleaning your oven.

**Do not** clean your oven with a steam cleaner.

**Do not** wash any part of your oven in a dishwasher.

### Enamelled Parts:

In order to keep enamelled parts as new, it is necessary to clean them frequently with mild warm soapy water and then dry with a cloth. Do not wash them while hot and never use abrasive powders or abrasive cleaning materials. Do not leave anything spilled onto enamelled parts for long periods of time.

### Stainless Steel:

Stainless steel parts must be cleaned frequently with mildly warm soapy water and a soft sponge and then dried with a soft cloth. Do not use abrasive powders or abrasive cleaning materials. Do not leave anything spilled onto stainless steel parts for long periods of time.

## Replacing the oven lamps

**WARNING:** Ensure that the appliance is switched off before replacing the lamp to avoid the possibility of electric shock.

Remove the glass cover of the lamp-holder as shown below.

Remove the lamp and replace with a lamp resistant to high temperatures (300°C) with the following characteristics:

- Voltage: 220-240V
- Wattage: 25W
- Type: E 14

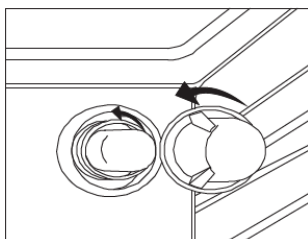

Replacement lamps are available from our Support Team. Replace the glass cover and reconnect the oven to the mains power supply.

**WARNING:** Please do not use screwdrivers or other utensils to remove the light cover. This could damage the enamel of the oven or the lamp holder lamp holder.

**PLEASE NOTE:** The bulb replacement is not covered by your guarantee.

# Care and maintenance

Looking after your appliance

## Technical Specifications

Model	LSBGHP/LSBCHP
Voltage and frequency	220-240V AC/50Hz
Total power(W)	2125-2560W
Oven usable capacity(L)	56
Oven energy rating	A

We apologise for any inconvenience caused by minor inconsistencies within these instructions that may occur due to product improvements and development  
All images and drawings are for illustration purposes only.



# Product support 6



# Product support

Help is always at hand

## Troubleshooting

PLEASE DO NOT attempt to repair this appliance yourself please contact the BUSH support contact centre on 01759 487838 or a qualified electrician

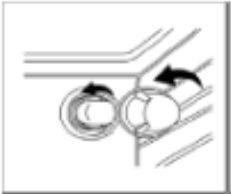
Problem	Possible Cause
The oven does not heat up	-The oven may not be switched on. Switch oven on. -A household fuse may have blown, or a circuit breaker may have tripped. Replace the fuses or reset the circuit. If this happens repeatedly, call an authorised electrician.
A noise can be heard after a cooking programme	The cooling fan remains switched on after the end of a cooking programme.
The light/lamp is not working 	-Disconnect the appliance from the electricity supply: Switch off and unplug at the socket, or disconnect the fuse, or switch off at the isolator as appropriate. -Turn the lamp turn anti-clockwise to release it and then pull it downwards to take it out. -Replace it with a new halogen lamp. -Refit the lamp cover and turn it clockwise to secure it. -Reconnect the appliance to the mains electricity supply.
Cakes and biscuits are browning unevenly	There will always be a slight unevenness. If browning is very uneven check that the correct temperature was set and that the correct shelf level was used.
Steam is coming from the oven	When cooking foods with a high-water content (e.g. oven chips) there may be some steam visible at the top of the door. Take care when opening the oven door, as there may be a momentary puff of steam when the door is opened. Stand well back and allow any steam to disperse.
The knobs get hot when I use the oven or the grill. Can I avoid this?	Yes, this is caused by heat rising from the oven or the grill and heating them up. Do not leave the oven door open. Make sure that the grill pan is pushed right back to the 'back stop' when grilling. Always grill with the compartment door closed.
Oven temperature getting hotter as the cooker gets older	If turning the temperature down using the oven control knob has not worked, or has only worked for a short time, then you may need a new thermostat. This should be fitted by a service person.
Grill not cooking properly	Are you using the pan and trivet supplied with the cooker? Is the pan being used on the runners, not the floor of the compartment? Is the grill tray pushed fully back to stop?
The oven is not cooking evenly	-If you are cooking a large item, be prepared to turn it round during cooking. -Ensure the shelves are in the correct positions.

If you require any technical guidance or find that your product is not operating as intended, a simple solution can often be found in the **Troubleshooting** section of these instructions,

# Product support

Help is always at hand

## Help and assistance

If you require any technical guidance or find that your Built-in Fan Oven is not operating as intended, a simple solution can often be found in the **Troubleshooting** section of these instructions or online at **[www.bush-support.com](http://www.bush-support.com)**

If you still require further assistance, call one of our experts on **01759 487838\***. To help give us give you a fast and efficient service please have the following information ready:

Model Ref.	<input type="text"/>	You can find these on the rating plate - a small information panel (usually a sticker or metal plate) on the rear of your appliance
Serial number	<input type="text"/>	
Date of purchase	<input type="text"/>	This will be shown on your receipt

Local call rates applies\*

Lines open 8am-7pm Monday to Saturday and 10am-4pm Sunday.

\*Calls to Bush enquiry lines may attract a charge and set up fee from residential lines depending on your call plan/tariff. Mobile and other providers costs may vary, see [www.bt.com/pricing](http://www.bt.com/pricing) for details.

For Security and training purposes, telephone calls to and from customer service centres maybe recorded and monitored. Calls from Republic of Ireland will attract international call charges.

or online at **[www.bush-support.com](http://www.bush-support.com)** If you still require further assistance, call one of our experts on **01759 487838**

## Declaration of conformance to product standards

This appliance conforms to all relevant standards applicable to domestic appliances sold in the UK

## Disposal



This appliance/fitting is marked according to the European directive 2012/19/EU on Waste Electrical and Electronic Equipment (WEEE).

By ensuring this product is disposed of correctly, you will help prevent potential negative consequences for the environment and human health, which could otherwise be caused by inappropriate waste handling of this product.

The symbol on the product, or on the documents accompanying the product, the **crossed out wheelie bin** symbol, indicates that this appliance/fitting may not be treated as household waste. Instead it shall be handed over to the applicable collection point for the recycling of electrical and electronic equipment.

Disposal must be carried out in accordance with local environmental regulations for waste disposal.

For more detailed information about treatment, recovery and recycling of this product, please contact your local authority, your household waste disposal service or the retailer where you purchased the product.





## Call us now and activate your 12 month guarantee

Thank you for choosing Bush. Your new product is guaranteed against faults and breakdowns for 12 months. Don't forget to register it with us today so we can provide you with our best possible after-sales service and useful updates.

**[www.bushregistration.co.uk](http://www.bushregistration.co.uk)**

FREEPHONE\*

**0800 597 8548**

Lines are open 8am - 8pm, 365 days a year. \*Calls may be recorded and monitored.

### Your Bush Guarantee

This product is guaranteed for twelve months from the date of original purchase. Any defect that arises due to faulty materials or workmanship will be repaired free of charge (or if applicable the product will be replaced or the purchase price refunded) where possible during this period by the dealer from who your purchased the unit.

The guarantee is subject to the following provisions:

- The guarantee does not cover accidental damage, misuse, cabinet parts, knobs or consumable items.
- The product must be correctly installed and operated in accordance with the instructions contained in the manual.
- It must be used solely for domestic purposes. The guarantee will be rendered invalid if the product is re-sold or has been damaged by inexpert repair.
- Specifications are subject to change without notice.
- Bush disclaim any liability for loss or damage arising from the breakdown of the product.
- This guarantee is in addition to and does not diminish your statutory or legal rights.

### Important Data Protection Information

To find out how we and Domestic & General Insurance Plc use your data please refer to the guarantee registration material or visit [www.bushregistrations.co.uk](http://www.bushregistrations.co.uk)

Guarantor: Argos Limited - 489 - 499 Avebury Blvd. - Milton Keynes - MK9 2NW

or online at [www.bush-support.com](http://www.bush-support.com) If you still require further assistance, call one of our experts on **01759 487838**





# BUSH



**Contact:**

[www.bush-support.com](http://www.bush-support.com)

Helpline: 01759 487838