

# Hisense

life reimagined

## USER'S OPERATION MANUAL

Before operating this unit, please read this manual thoroughly, and retain for future reference

English

## Contents

Safety and warning information.....	2	Cleaning and care.....	18
Installing your new appliance.....	8	Helpful hints and tips.....	20
Description of the appliance.....	14	Troubleshooting.....	21
Display controls.....	15	Disposal of the appliance.....	23
Using your appliance.....	17		



This appliance is in accordance with the following EU guidelines: LVD 2014/35/EU and EMC 2014/30/EU and 2009/125/EC and EC.1060/2010 and 2002/96/EC.



## Safety and warning information

For your safety and correct usage, before installing and first using the appliance, read this user manual carefully, including its hints and warnings. To avoid unnecessary mistakes and accidents, it is important to make sure that all people using the appliance are thoroughly familiar with its operation and safety features. Save these instructions and be sure that they remain with the appliance if it is moved or sold, so that anyone using it throughout its life will be properly informed on usage and safety notices.

For the safety of life and property, keep the precautions of these user's instructions as the manufacturer is not responsible for damages

caused by omission.

### **Safety for children and others who are vulnerable**

- This appliance can be used by children aged from 8 years and above, and persons with reduced physical, sensory or mental capabilities or lack of experience and knowledge if they have been given supervision or instruction concerning use of the appliance in a safe way and understand the hazards involved. Children shall not play with the appliance. Cleaning and user maintenance shall not be made by children without supervision.
- Keep all packaging away from children as there is risk of suffocation

- If you are discarding the appliance, pull the plug out of the socket, cut the connection cable (as close to the appliance as you can) and remove the door to prevent children playing from suffering an electric shock or from closing themselves inside.
- If this appliance, featuring a magnetic door seals, is to replace an older appliance having a spring lock (latch) on the door or lid, be sure to make the spring lock unusable before you discard the old appliance. This will prevent it from becoming a death trap for a child

### General safety



- **WARNING** — This appliance is intended to be used in households and similar applications such as
  - staff kitchen areas in shops, offices and other working environments;
  - farm houses and by clients in hotels, motels and other residential type environments;
  - bed and breakfast type

- environments;
  - catering and similar nonretail applications
- **WARNING** — The water supply line should only be connected to a potable water supply.
- **WARNING** — Do not store explosive substances such as aerosol cans with a flammable propellant in this appliance.
- **WARNING** — If the supply cord is damaged, it must be replaced by a qualified electrician in order to avoid the risk of electric shock.
- **WARNING** — Keep ventilation openings in the appliance enclosure or in any built-in structure clear of obstruction.
- **WARNING** — Do not use mechanical devices or other means to accelerate the defrosting process, other than those recommended by the manufacturer.
- **WARNING** — Do not damage the refrigerant circuit.
- **WARNING** — Do not use electrical appliances inside the food storage compartments of the

appliance, unless they are of the type recommended by the manufacturer.

- **WARNING** — The refrigerant and insulation are flammable. When disposing of the appliance, do so only at an authorized waste disposal center. Do not expose to flame.

## Refrigerant

The refrigerant isobutene (R600a) is contained within the refrigerant circuit of the appliance, a natural gas with a high level of environmental compatibility, which is nevertheless flammable.

During transportation and installation of the appliance, ensure that none of the components of the refrigerant circuit becomes damaged.

The refrigerant (R600a) is flammable.

- **WARNING** — Refrigerators contain refrigerant and gases in the insulation. Refrigerant and gases must be disposed of professionally as they may cause eye injuries or ignition. Ensure that tubing of the

refrigerant circuit is not damaged prior to proper disposal.



### **Caution: risk of fire**

If the refrigerant circuit is damaged:

- Avoid naked flames and sources of ignition.
- Thoroughly ventilate the room in which the appliance is situated.

It is dangerous to alter the specifications or modify this product in any way.

Any damage to the cord may cause a shortcircuit, fire, and/or electric shock.



### **Electrical safety**

1. The power cord must not be lengthened.
2. Make sure that the power plug is not crushed or damaged. A crushed or damaged power plug may overheat and cause a fire.
3. Make sure that you can access the main plug of the appliance.
4. Do not pull the main cable.
5. If the power plug socket is loose, do not insert the power plug. There is a risk

of electric shock or fire.

6. You must not operate the appliance without the interior lighting lamp cover.

7. The fridge is only supplied with power supply of single phase alternating current of 220 ~ 240 V/50Hz. If fluctuation of voltage in the district of user is so large that the voltage exceeds the above scope, for safety sake, be sure to apply A.C.

Automatic voltage regulator of more than 350W to the fridge. The fridge must employ a special power socket instead of common one with other electric appliances. Its plug must match the socket with ground wire.

### **Daily use**

- Do not store flammable gas or liquids in the appliance. There is a risk of an explosion.
- Do not operate any electrical appliances in the appliance (e.g. electric ice cream makers, mixers etc.).
- When unplugging always pull the plug from the mains socket, do not pull on the cable.

- Do not place hot items near the plastic components of the fridge.
- Do not place food products directly against the air outlet on the rear wall.
- Store pre-packed frozen food in accordance with the frozen food manufacture's instructions.
- The manufactures storage recommendations should be strictly adhered to. Refer to relevant instructions for storage.
- Do not place carbonated or fizzy drinks in the freeze compartment as it creates pressure on the container, which may cause it to explode, resulting in damage to the appliance.
- Frozen food can cause frost burns if consumed straight from the freezer compartment.
- Do not place the appliance in direct sunlight.
- Keep burning candles, lamps and other items with naked flames away from the appliance so that do not set the appliance on fire.
- The appliance is intended

for keeping food and/or beverages in normal households as explained in this instruction booklet. The appliance is heavy. Care should be taken when moving it.

- Do not remove or touch items from the freezer compartment if your hands are damp/wet, as this could cause skin abrasions or frost/freezer burns.
- Never use the base, drawers, doors etc. to stand on or as supports.
- Frozen food must not be refrozen once it has been thawed out.
- Do not consume ice popsicles or ice cubes straight from the freezer as this can cause freezer burn to the mouth and lips.
- To avoid items falling and causing injury or damage to the appliance, do not overload the door racks or put too much food in the crisper drawers.

### **Caution!**

#### **Care and cleaning**

- Before maintenance, switch

off the appliance and disconnect the mains plug from the mains socket.

- Do not clean the appliance with metal objects, steam cleaner, ethereal oils, organic solvents or abrasive cleansers.
- Do not use sharp objects to remove frost from the appliance. Use a plastic scraper.

#### **Installation important!**

For electrical connection carefully, follow the instructions given in this manual.

- Unpack the appliance and check if there are damages on it. Do not connect the appliance if it is damaged. Report possible damages immediately to the place you bought it. In this case retain packing.
- It is advisable to wait at least four hours before connecting the appliance to allow the oil to flow back in the compressor.
- Adequate air circulation should be allowed around the appliance reducing the risk of overheating. To

---

achieve sufficient ventilation, follow the instructions relevant to installation.

- Wherever possible the back of the product should not be close to a wall to avoid touching or catching warm parts (compressor, condenser) to prevent the risk of a fire, follow the instructions relevant to installation
- The appliance must not be locate close to radiators or cookers.

- Make sure that the mains plug is accessible after the installation of the appliance.

### **Service**

- Any electrical work required to do the servicing of the appliance should be carried out by qualified electrician or competent person. This product must be serviced by an authorized Serviced Center, and only genuine spare parts must be used.

## Installing your new appliance

Before using the appliance for the first time, you should be informed of the following tips.

### Warning!

For proper installation, this refrigerator must be placed on a level surface of hard material that is the same height as the rest of the flooring. This surface should be strong enough to support a fully loaded refrigerator.

The rollers, which are not castors, should be only used for forward or backward movement. Moving the refrigerator sideways may damage your floor and the rollers.

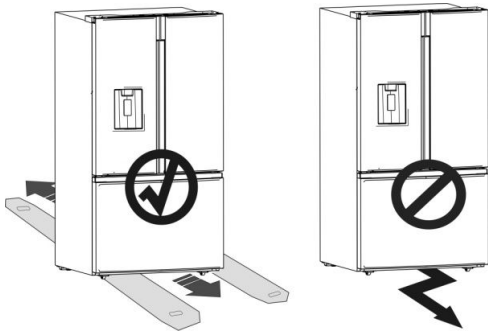

### Ventilation of appliance



Install the appliance in a plane and stable surface. Assure good ventilation.

We recommend letting a space at least:

- 75mm from the back to the wall
- 100mm from the top to the wall
- 100mm from its side to the wall

Enough space must be provided in the front of the appliance to allow the doors to open as shown in follow diagrams.

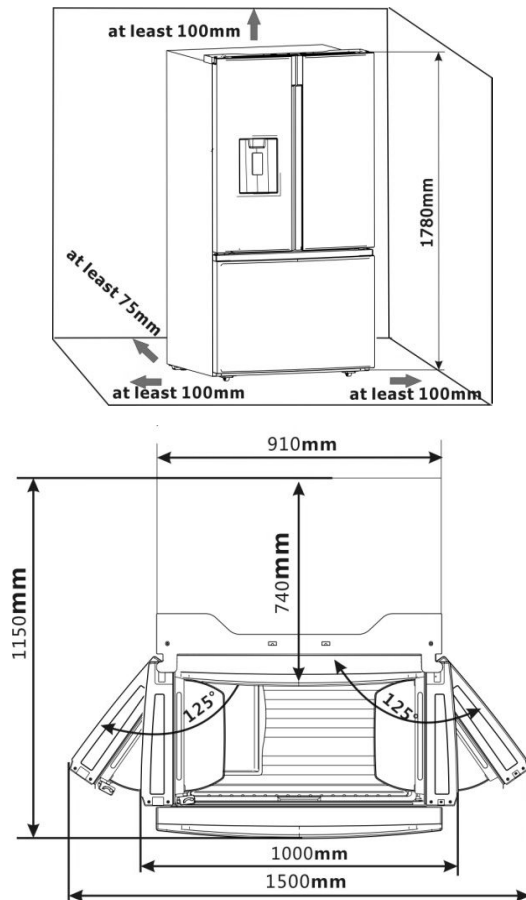

### Note:

- This appliance performs well within the climate class from SN to T showed in the table below. It may not work properly if being left at a temperature above or below the indicated range for a long period.

Climate class	Ambient temperature
SN	+10°C to +32°C
N	+16°C to +32°C
ST	+16°C to +38°C
T	+16°C to +43°C

- Stand your appliance in a dry place to avoid high moisture.
- Keep the appliance out of direct sunlight, rain or frost. Stand the appliance away from heat sources such as stoves, fires or heaters.

### Leveling of appliance

- For sufficient leveling and air circulating in the lower rear section of the appliance,



the bottom feet may need to be adjusted. You can adjust them manually by hand or by using a suitable spanner.

- To allow the doors to self-close, tilt the top backwards by 10-15 mm.
- Whenever you want to move the appliance, remember to turn the feet back up, so that the appliance can roll freely. Reinstall the appliance when relocating.

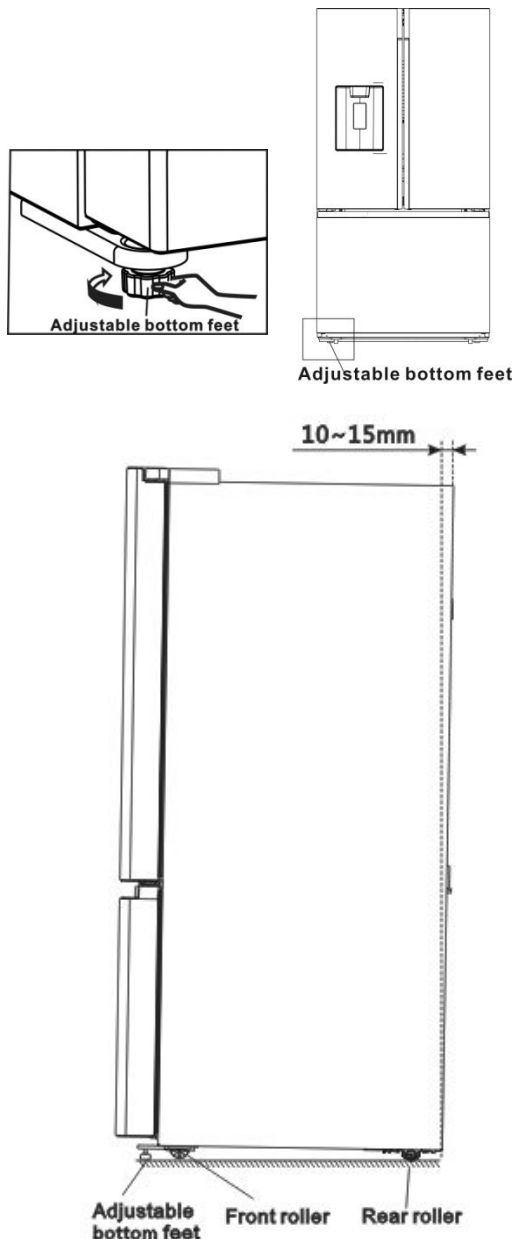

### Doors removal

In case when your access door is too narrow for the refrigerator to pass through, remove the refrigerator door and drawers.

Then pass the refrigerator laterally. If you do not need to remove the appliance doors, go to 'Installing the water lines' on page 11. If you need to remove the doors, continue below.

### Warning!

When reversing the door, the appliance must be unplugged.

### The tools you will need (Not provided):

Allen Wrench(4mm)	Wrench(8mm)
Philips screwdriver	

### Disassembling the fridge door

Some models may be slightly different from pictures. If some parts shown in the picture cannot be found in your appliance, please ignore the relevant description.

1. With the door closed, remove the 3 screws holding the top cover (A) with Philips (+) screwdriver, and then remove the top cover carefully with the entire-harnesses unattached.

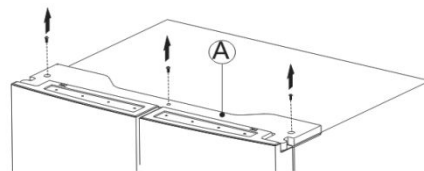

2. Take out connectors and the water coupler from the installation clip. Remove the two wire connectors (press the top of the connector (B) and separate it from the other one) on the left side door. To remove the water coupler from the hinge, twist and pull the clips from the coupler then remove the water line (C) while pressing the movable part (D) of the water line coupler.

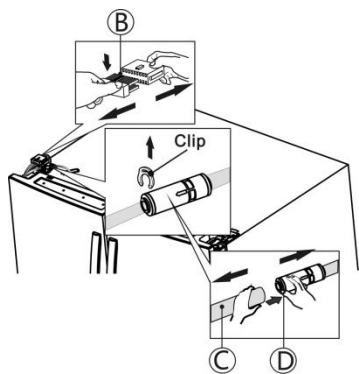

3. Remove the 3 screws (B) fixed on the hinges with a Wrench (8mm) and 1 ground screws (C) attached to the hinge with Philips (+) screwdriver. Remove the upper left and right door hinges (D).

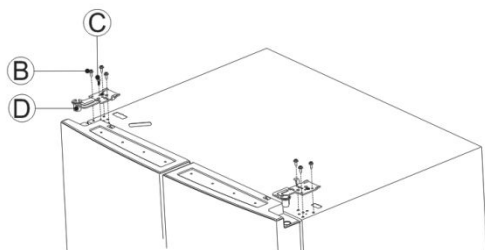

4. Use your both hands to open the door more than  $90^\circ$ . Lift it up and take it off. (Be careful of racks while remove the door.)

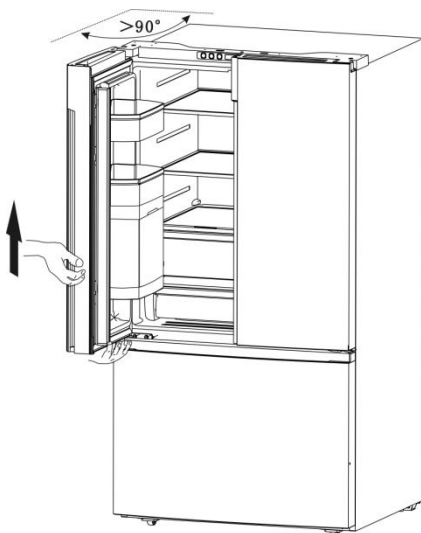

5. Remove the 4 hex head bolts (E) with an Allen wrench (4 mm). Remove the 2 screws with screwdriver. Then remove the lower left and right door hinges (F).

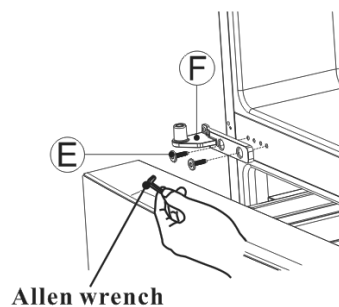

### Re-attaching the fridge doors

To reattach the fridge doors after you have moved the appliance to its final location, assemble the parts in reverse order.

1. To prevent water leaks, the water line should be fully inserted into the center of the coupler until the guide lines are coincided exactly with the head of the movable part.

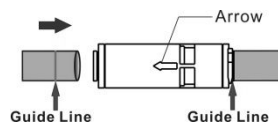

### Note:

Arrow on the water line coupler point to the direction of the door.

2. Make sure the clips are properly connected to the coupler.

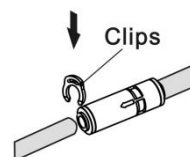

### Caution!

In case the fridge doors can't be self-closed, please make sure the door opened more than  $90^\circ$  when you remove or re-attaching the fridge doors.

### Disassembling the freezer door

1. Pull out the freezer door and the upper freezer drawer (A) to the final position. Then take out the ice box (B) by lifting it up in the direction of the arrow.

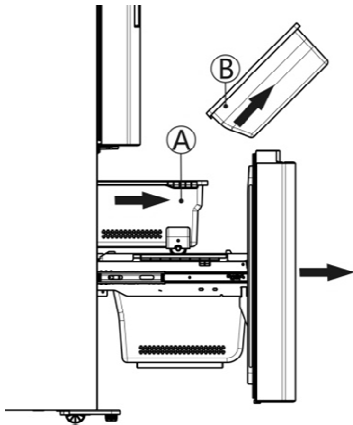

2. Take out the upper freezer drawer (A) by lifting it up from the rail system.

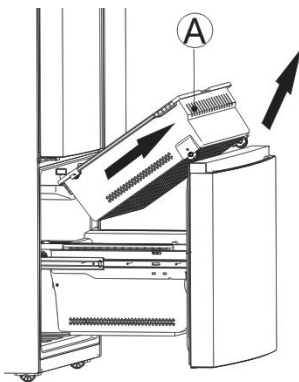

3. Remove the lower freezer drawer (C) by lifting it up.

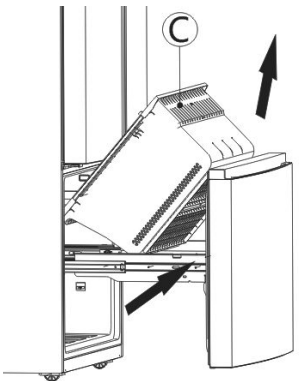

4. Remove the 4 screws attached to the supporting frame (D).

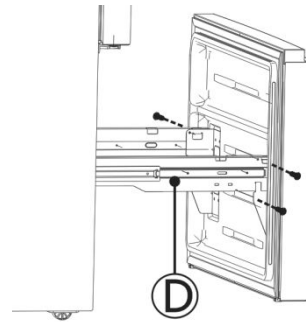

5. Pull out the freezer door and lift it up in the direction of the arrow.

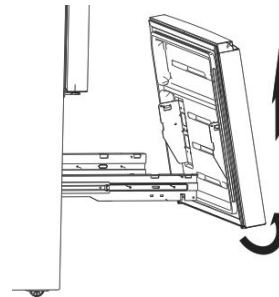

#### Re-assembling the freezer door

To reattach the drawer after you moved the appliance to its final location, assembling the parts in reverse order.

#### (Optional)

#### Installing the water lines and filter

##### Installing the water filter

To fit the water filter, follow the installing steps below.

1. Take out the water filter and water lines from the fridge room.
2. Determine the location to mount the external filter. (Note: The water filter should be mount on the wall where it is convenient to be replaced, and do not mount on the wall behind the refrigerator.)
3. Determine the distance between the filter and the tap, and the distance from the filter to the fridge. Prepare lines as required lengths. (Cut the proper lengths of water lines which you determine to connect with the filter inlet or outlet.)
4. Mount the filter holder onto the wall by using a screwdriver and attach the water filter.

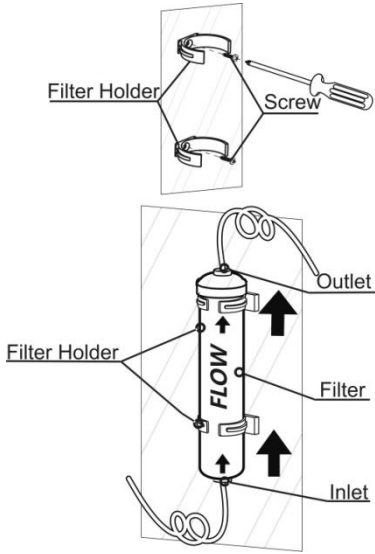

**Note:**

- The water lines must be fully inserted into the filter to prevent water leaking.
- The line length should be less than 5m. If the water line is too long(>5m), the ice and cold water content may be affected due to insufficient water pressure.
- Cut the water line as required length and avoid overbending the water lines.
- It is recommended to have a suitably qualified person to install the product.

**Warning!**

- The water filter must be held upright as shown in the figure above. It is critical to connect the water inlet and outlet hoses on the filter correctly.
- Never mount the filter onto the refrigerator. Coolant pipes might be pierced.

**Installing the water lines of the filter**

To install the water lines of the filter, follow the instructions of installing steps below that referring to the figures supplied.

1. Take the 2 clips out, then pull out the 2 stopper of the water filter.

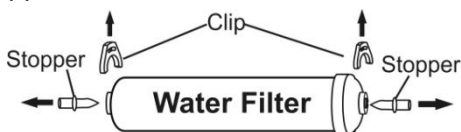

2. Fully insert the water lines into the Inlet

and Outlet of the water filter.

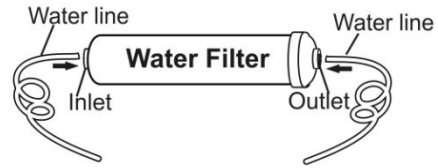

3. Insert the 2 clips in the proper position as the figure shown below, and confirm that each clip holds the water line firmly.

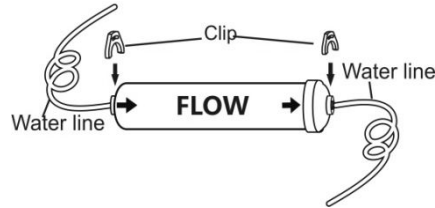

**Connecting the filter inlet line to the water supplier**

The connector and the check valve is provided as one part. You should use the new connector incidentally but not the old one you have.

Screw the adaptor onto a suitable 3/4" BSP connector water outlet, and use the spanner to tighten it. Fully insert the water line into the check valve. Then insert the clip in the install pack as the figure shown below.

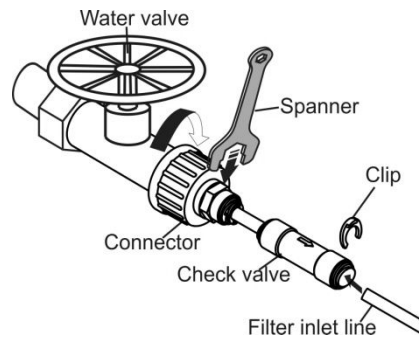

**Note:**

- After installed the filter, please open the water valve to flush the filter for 5 minutes before use.

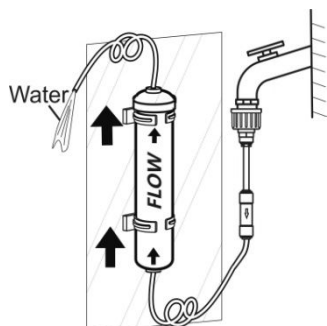

- The initial dark discoloration of water is normal.
- The water lines must be connected with the potable water only.
- To operate properly, the ice maker requires a water pressure of 207~689 Kpa.

#### Connect filter outlet line to the fridge

The outlet line of the water filter should be connected with the inlet line of the refrigerator by a Two-Way Connector. The water lines must be fully inserted into the center of the connector to prevent water leaking.

Insert the 2 clips in the install pack as shown in the diagram, and then confirm that each clip holds the line firmly.

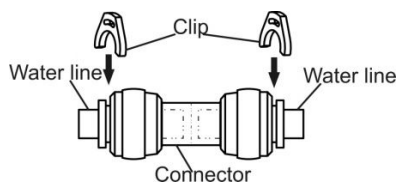

Open the water valve to flush the lines, and check leakage in the water connectors. If any leak, please check that

if the lines are fully inserted where the connector leaked. If not, please install them again, and make sure that the lines are fully inserted.

#### Note:

- After connect the filter outlet line with the refrigerator(as shown in the diagram below), please dispense several cups of water to flush the lines before use.

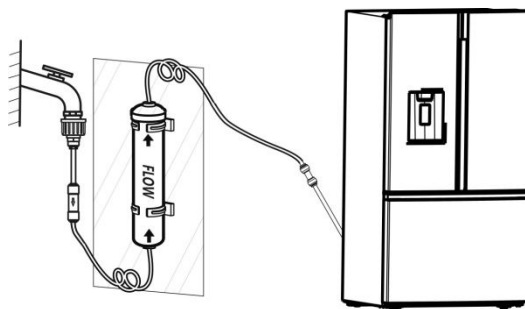

- The water lines should not be pressed by heavy things and should not bend too much.

#### Warning!

- After turning on the water valve, make sure that there is no leakage at all connection points of the water lines. If there is a leakage, turn off the valve immediately and tighten the water connector or make the lines fully inserted into the connector.
- Do not pull the water lines hard, it may damage the water system.

## Description of the appliance

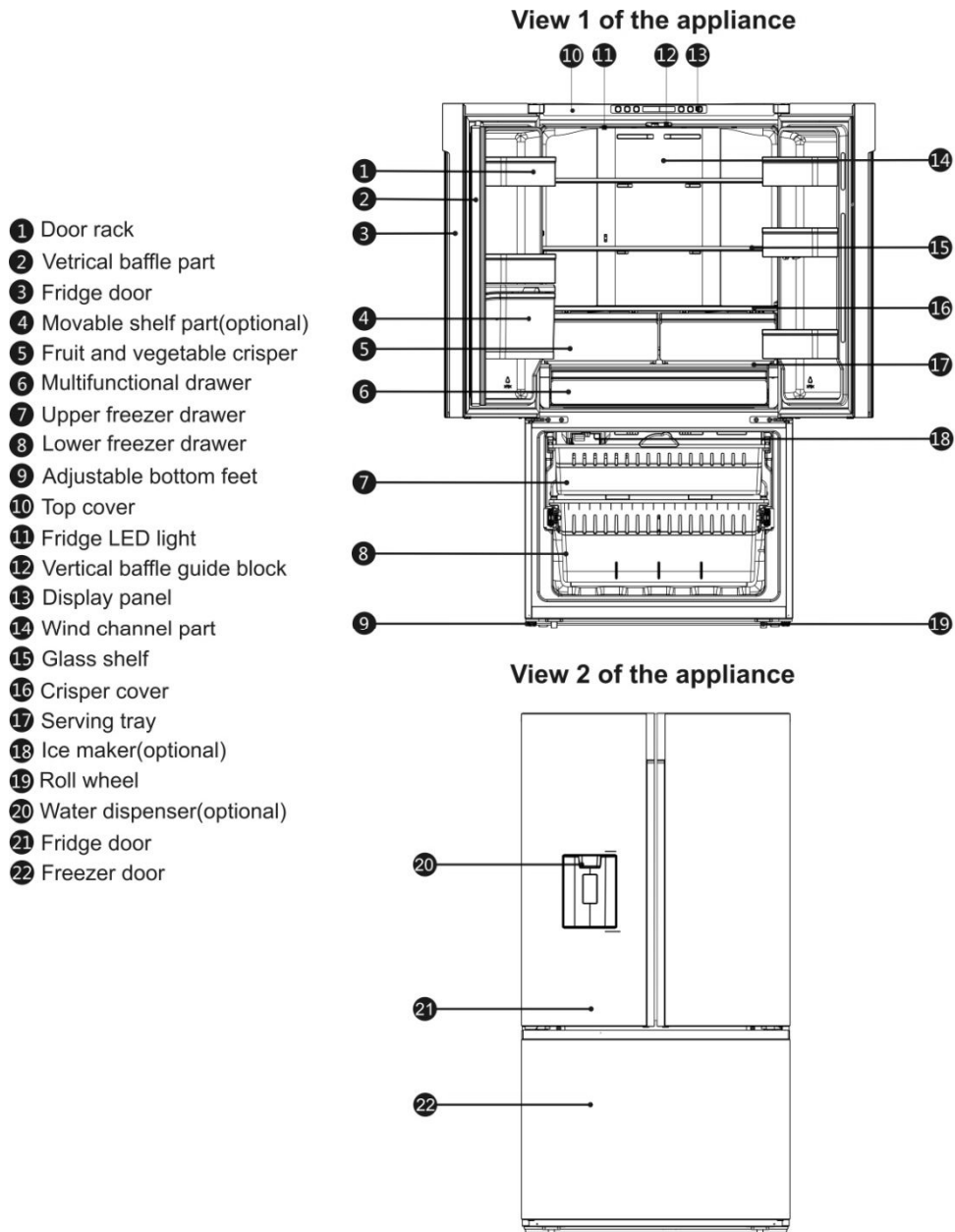

### Note!

- Due to unceasing modification of our products, your refrigerator may be slightly different from this instruction manual, but its functions and using methods remain the same.
- To get the best energy efficiency of this product, please place all shelves, drawers and baskets on their original position as the illustration above.

## Display Controls

Use your appliance according to the following control guidelines. The control panel on the top cover shows in the diagram below, it may be different depending on the model.

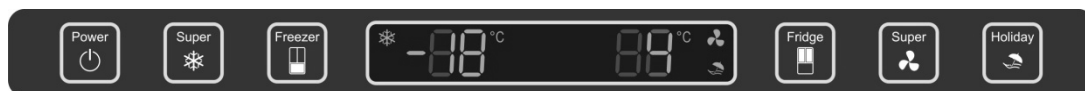
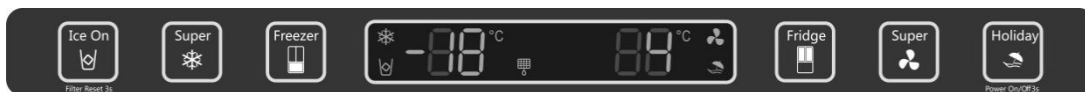

When the appliance is powered on for the first time, the backlighting of the icons on the display panel starts working. If no buttons have been touched or the doors are closed, the backlighting will turn off after 60 seconds.

The control panel consists of two areas about temperature, and one area about different modes.

### Caution!

When you set a temperature, you set an average temperature for the whole refrigerator cabinet. Temperatures inside each compartment may vary from the temperatures displayed on the panel, depending on how much food you store and where you place it. High or low room temperature may also affect the actual temperature inside the appliance.



### “Ice Control”

This button controls the ice maker. You can touch "Ice On " button to control the ice maker. When the "ice On " function light is on, the ice maker is working. If you want to turn off the ice maker, please touch the "Ice On " button again.



### “Super Freeze”

If you want to decrease the time needed to freeze products in the Freezer, please touch this button, the super cool icon ‘❄️’

will be illuminated, the fridge temperature setting displays -24°C.

Super Freezer can quickly lower the temperature and freeze your food faster than usual. This can retain more of the vitamins and nutrition in fresh food and keep your food longer.

The super freeze option allows you to freeze the maximum amount of possible. We recommend that you let the appliance operates for 6 hours first. Super freeze automatically switches off after about 52 hours, and the freezer temperature setting will revert back to the previous setting.

When the super freeze function is on, you can touch “Super Freeze ” button again to switch off. And it will not retain the Super Freeze function when power off.



### “Water Filter”

In general, you should change the water filter every 6 months to ensure the highest possible water quality.

After the refrigerator has dispensed about 1000 gallons of water(used the water filter for about 6 months), the filter icon “🔍” will blink, that remind you need to replace the water filter.

First of all, you need to purchase a new water filter. You can purchase the new filter from the retailer where you purchased your refrigerator or the after-sales service system. Before that please check that the new filter is the same filter type as before

that can be correctly used in your refrigerator.

After you change a new water filter, ensure to touch and hold the “Ice On” and “Super Freeze” buttons for 3 seconds to make the blink off. When you replace the water filter, some water may leak from the filter and lines. Please let the water flow in a pan, and wipe up any leakage that may have occurred.



#### “Freezer temperature control”

You can touch the “Freezer” button to activate the mode to control the freezer temperature. When you press the button continuously, the temperature will be set in the following sequence.



#### “Fridge temperature control”

You can touch the “Fridge” icon to activate the mode to control the fridge temperature. When you touch the button continuously, the temperature will be set in the following sequence.

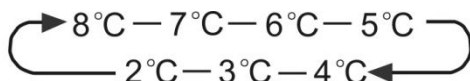

#### “Super Cool”

If you want to decrease the time needed to cool products in the Fridge, please touch this button, the super cool icon “” will be illuminated, the fridge temperature setting displays 2°C.

Super cool automatically switches off after 3 hours, and the refrigerator temperature setting will revert back to the previous

setting.

When super cool function is on, you can touch the “Super Cool” button again to switch it off. The fridge will not retain the Super Cool function when power off.



#### “Holiday”

If you are going to be away for a long period of time such as a long holiday or business trip, you can activate this function by touching the “Holiday” button, and the icon “” will be illuminated.

When the holiday function is activated, the temperature of the fridge is automatically switched to 15°C and the freezer to -18°C to minimize the energy consumption.

When the holiday function is on, you can switch off it by touching “Holiday” again, and the icon “” will be off. When the holiday function is on, the Ice maker/ Super Freeze/ Super Cool will automatically turn off. The refrigerator will retain the setting when powered off.

#### Note:

- Do not store any food in the fridge during the “Holiday” time, or it will quickly deteriorate.
- The refrigerator temperature setting will revert back to the previous setting after the holiday function is off.
- If word "Power on/Off 3s" is under this button, you can switch on or switch off your appliance by press this button. Press for 3 seconds, after a buzzer sound, the appliance will be turned off or turn on.



#### “Power on/off” (Optional)

You can switch on or switch off your appliance by press this button.



### Alarm

•When the door of fridge or freezer has been opened for over 2 minutes, the door alarm will sound. In case of door alarm, buzzer will sound 3 times every 1 minute and will stop alarming automatically after

10 minutes.

•To save energy, please avoid keeping the door open for a long time when using the appliance. The door alarm can also be cleared by closing the door.

## Using your appliance

This section tells you how to use most of the useful features. We recommend that you read through them carefully before using the appliance. It may be different depending on the model

### 1. Using your refrigerator compartment

The refrigerator compartment is suitable for storage of vegetables and fruit. Food inside should be packed to store in order to avoid losing moisture or flavor permeating into other foods.

**Caution!** Never close the refrigerator door while the shelves, crisper and/or telescopic slides are extended. It may damage both them and the refrigerator.

#### Glass shelves and Door racks

The refrigerator compartment is provided with several glass shelves and several different door racks, which are suitable for the storage of eggs, canned liquid, bottled drinks and packed food. They can be placed at different heights according to your need. But do not place too many heavy things in racks. Before you lift up the door shelf vertically, please take the food out.

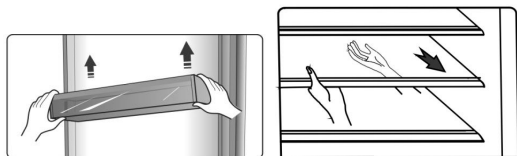

**Note:** All the door racks and shelves can be taken out to be cleaned.

When you remove the shelves, gently pull them forward until the shelf comes clear of the shelf guides.

When you return the shelves, make sure

there is no obstacle behind and gently push the shelf back into the position.

#### Drawers

These are suitable for storage of fruits and vegetables. And it can be taken out to be cleaned.

To take them out, open the door to the final location first. Then pull out the drawer and tilt up the front of the crisper after moving slightly in the direction.

#### Sealing board(optional)

Sealing board can partly prevent water desorption of food in the fruit and vegetable crisper. You can move the slider to control the humidity of crisper.

#### Note:

Put too much food in crisper may impact the function of sealing board.

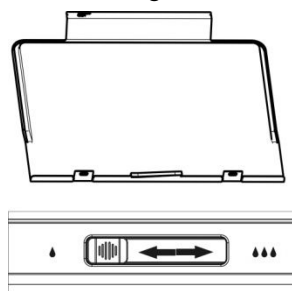

### 2. Using the dispenser (optional)

#### Getting cold water

The water dispenser is located on the left fridge door. Move your cup down the dispenser lever in the suggested position and press it.

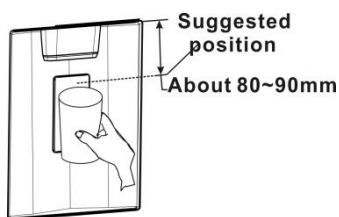
**Note:**

- Don't push the dispenser lever forward without cup, it may cause the water leak from the dispenser.
- Do not immediately removing your cup or glass from the dispenser after dispensing water you need. You should wait for 2 or 3 seconds to prevent spills.
- Do not pull the lever out, it could damage or break the lever's spring.
- Dispenser does not work when door is not closed.
- Take water frequently or largely or you first use this function, the water may not cold enough. Please wait for some time to ensure the appropriate temperature.
- 

**Water clouding phenomenon**

All water provided to the refrigerator flows through the filter which is an alkaline water filter. In the filtering process, the pressure of the water that has flowed out of the filter is increased, and the water becomes saturated with oxygen and nitrogen. When this water flows out into the air, the pressure plummets and the oxygen and nitrogen get supersaturated, which results in gas bubbles. The water may temporarily look misty or cloudy due to these oxygen bubbles. After a few seconds, the water will look clear.

**3.Using the freezer compartment**

The freezer compartment is provided with an upper drawer, a lower drawer and a ice box(optional). To remove all of them, refer

to page 10 for disassembly instruction.

**Automatic Icemaker (optional)**

Automatic Icemaker can make ice automatic.

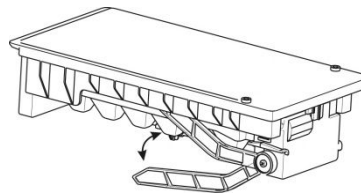
**Note:**

- When the ice maker dumps ice into the ice box, any sounds you hear are part of normal operation.
- If you do not dispense ice for a long periods of time, Ice may clump in the Ice box. If this occurs, please remove all the ice and empty the box
- If you are going on a long vacation or business trip and won't be using the water dispenser or ice maker part for period of time, please close the water valve to prevent leaks.
- The ice made by the ice maker first batches cannot be used for eating or drinking cause it is unhealthiness.
- Cannot store liquid cans in ice box, it may cause burst.

**warning!**

Do not allow your children to hang off the dispenser or touch the ice maker. This could cause injury.

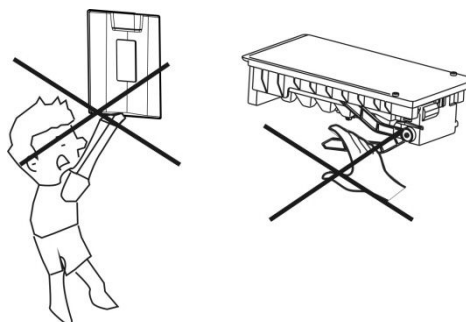
**Cleaning and care**

For hygienic reasons the appliance (including exterior and interior accessories)

should be cleaned regularly at least every two months.

**Warning!**

The appliance must not be connected to the mains during cleaning. Danger of electrical shock! Before cleaning switch the appliance off and remove the plug from the mains socket.

**Exterior cleaning**

To maintain good appearance of your appliance, you should clean it regularly.

- Spray water onto the cleaning cloth instead of spraying directly on the surface of the appliance. This helps ensure an even distribution of moisture to the surface.
- Clean the doors, handles and cabinet surfaces with a mild detergent and then wiped dry with a soft cloth.

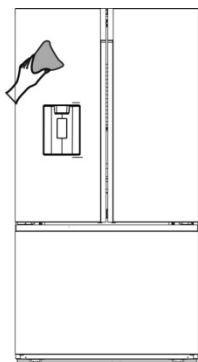
**Caution!**

- Don't use sharp objects as they are likely to scratch the surface.
- Don't use Thinner, Car detergent, Clorox, ethereal oil, abrasive cleansers or organic solvent such as Benzene for cleaning. They may damage the surface of the appliance and may cause fire.

**Interior cleaning**

You should clean the appliance interior regularly. It will be easier to clean when food stocks are low. Wipe the inside of the fridge freezer with a weak solution of bicarbonate of soda, and then rinse with warm water using a wrung-out sponge or cloth. Wipe completely dry before replacing the shelves and baskets. Thoroughly dry all surfaces and removable

parts before putting them back into place.

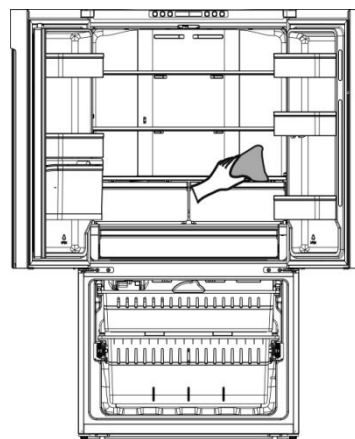

Although this appliance automatically defrosts, a layer of frost may occur on the freezer compartment's interior walls if the freezer door is opened frequently or kept open too long. If the frost is too thick, choose a time when the freezer is nearly empty and proceed as follow:

1. Remove existing food and accessories baskets, unplug the appliance from the mains power and leave the doors open. Ventilate the room thoroughly to accelerate the process.
2. When defrosting is completed, clean your freezer as described above.

**Warning!**

Do not use sharp objects to remove frost from the freezer compartment. Only after the interior is completely dry should the appliance be switched back on and plugged back into the mains socket.

**Door seals cleaning**

Take care to keep door seals clean. Sticky food and drinks can cause seals to stick to the cabinet and tear when you open the door. Wash seal with a mild detergent and warm water. Rinse and dry it thoroughly after cleaning.

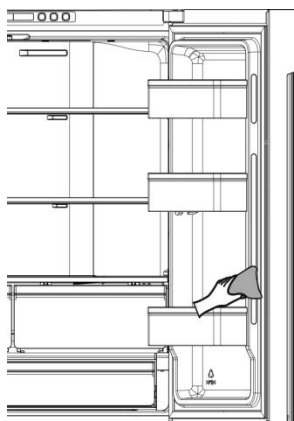

**Caution!** Only after the door seals are completely dry should the appliance be powered on

### Replacing the LED light

**Warning:** The LED light must be replaced by a competent person. If the LED light is damaged, follow the steps below:

1. Unplug your appliance.
2. Remove light cover by rising up and pulling out the LED light.
3. Hold the LED light with one hand and pull it with the other hand while pressing the connector latch.
4. Replace LED light and snap it correctly in place and recover the light cover.

## Helpful hints and tips

### Energy saving tips

We recommend that you follow the tips below to save energy.

- Try to avoid keeping the door open for long periods in order to conserve energy. Ensure the appliance is away from any sources of heat (Direct sunlight, electric oven or cooker etc)
- Don't set the temperature colder than necessary.
- Don't store warm food or evaporating liquid in the appliance.
- Place the appliance in a well ventilated, humidity free, room. Please refer to Installing your new appliance chapter.
- If the diagram shows the correct combination for the drawers, crisper and shelves, do not adjust the combination as this is designed to be the most energy efficient configuration.

### Hints for fresh food refrigeration

- Do not place hot food directly into the refrigerator or freezer, the internal temperature will increase resulting in the compressor having to work harder and will consume more energy.
- Do cover or wrap the food, particularly if it

has a strong flavor.

- Place food properly so that air can circulate freely around it.

### Hints for refrigeration

- Meat (All Types) Wrap in polythene food: wrap and place on the glass shelf above the vegetable drawer. Always follow food storage times and use by dates suggested by manufacturers.
- Cooked food, cold dishes, etc.: They should be covered and may be placed on any shelf.
- Fruit and vegetables: They should be stored in the special drawer provided.
- Butter and cheese: Should be wrapped in airtight foil or plastic film wrap.
- Milk bottles: Should have a lid and be stored in the door racks.

### Hints for freezing

- When first starting-up or after a period out of use, let the appliance run at least 2 hours on the higher settings before putting food in the compartment.
- Prepare food in small portions to enable

it to be rapidly and completely frozen and to make it possible to subsequently thaw only the quantity required.

- Wrap up the food in aluminum foil or polyethylene food wraps which are airtight,
- Do not allow fresh, unfrozen food to touch the food which is already frozen to avoid temperature rise of the latter.
- Iced products, if consumed immediately after removal from the freezer compartment, will probably cause frost burns to the skin.
- It is recommended to label and date each frozen package in order to keep track of the storage time.

#### Hints for the storage of frozen food

- Ensure that frozen food has been stored

correctly by the food retailer

- Once defrosted, food will deteriorate rapidly and should not be re-frozen. Do not exceed the storage period indicated by the food manufacturer.

#### Switching off your appliance

If the appliance needs to be switched off for an extended period, the following steps should be taken prevent mould on the appliance.

1. Remove all food.
2. Remove the power plug from the mains socket.
3. Clean and dry the interior thoroughly.
4. Ensure that all the doors are wedged open slightly to allow air to circulate.

## Troubleshooting

If you experience a problem with your appliance or are concerned that the appliance is not functioning correctly, you can carry out some easy checks before calling for service, please see below.

**Warning!** Don't try to repair the appliance yourself. If the problem persists after you have made the checks mentioned below, contact a qualified electrician, authorized service engineer or the shop where you purchased the product.

**Warning!** A child entrapment warning statement shall be included in either the operating instructions or in a use and care manual provided with each refrigerator and shall include the following or equivalent wording: **DANGER:** Risk of child entrapment. Before you throw away your old refrigerator or freezer:

- Take off the doors.
- Leave the shelves in place so that children may not easily climb inside.

Problem	Possible cause & Solution
Appliance is not working correctly	Check whether the power cord is plugged into the power outlet properly.
	Check the fuse or circuit of your power supply, replace if necessary.
	The ambient temperature is too low. Try setting the chamber temperature to a colder level to solve this problem.
	It is normal that the freezer is not operating during the defrost cycle, or for a short time after the appliance is switched on to protect the compressor.

Odours from the compartments	<p>The interior may need to be cleaned</p> <p>Some food, containers or wrapping cause odours.</p>
Noise from the appliance	<p>The sounds below are quite normal:</p> <ul style="list-style-type: none"> <li>•Compressor running noises.</li> <li>•Air movement noise from the small fan motor in the freezer compartment or other compartments.</li> <li>•Gurgling sound similar to water boiling.</li> <li>•Popping noise during automatic defrosting.</li> <li>•Clicking noise before the compressor starts.</li> <li>• Clicking noise when you get the water.</li> <li>• The motor running noises when you get the ice.</li> </ul> <p>Other unusual noises are due to the reasons below and may need you to check and take action:</p> <p>The cabinet is not level.</p> <p>The back of appliance touches the wall.</p> <p>Bottles or containers fallen or rolling.</p>
The motor runs continuously	<p>It is normal to frequently hear the sound of the motor, it will need to run more when in following circumstances:</p> <ul style="list-style-type: none"> <li>•Temperature setting is set colder than necessary</li> <li>•Large quantity of warm food has recently been stored within the appliance.</li> <li>•The temperature outside the appliance is too high.</li> <li>•Doors are kept open too long or too often.</li> <li>•After your installing the appliance or it has been switched off for a long time.</li> </ul>
A layer of frost occurs in the compartment	<p>Check that the air outlets are not blocked by food and ensure food is placed within the appliance to allow sufficient ventilation. Ensure that door is fully closed. To remove the frost, please refer to the “Cleaning and care” chapter.</p>
Temperature inside is too warm	<p>You may have left the doors open too long or too frequently; or the doors are kept open by some obstacle; or the appliance is located with insufficient clearance at the sides, back and top</p>
Temperature inside is too cold	<p>Increase the temperature by following the “Display controls” chapter.</p>
Doors can't be closed easily	<p>Check whether the top of the refrigerator is tilted back by 10-15mm to allow the doors to self close, or if something inside is preventing the doors from closing.</p>
The light is not working	<ul style="list-style-type: none"> <li>•The LED light may be damaged. Refer to replace LED lights in cleaning and care chapter.</li> <li>•The control systems has disabled the lights due to the door being kept open too long, close and reopen the door to reactivate the lights.</li> </ul>

Ice is not dispensing	<ul style="list-style-type: none"> <li>•Did you wait for 12 hours after installation of the water supply line before making ice? If it is not sufficiently cool, it may take longer to make ice, such as when first installed.</li> <li>•Is the water line connected and the water valve open?</li> <li>•Did you manually stop the ice making function? Make sure you do not set the ice off mode.</li> <li>•Is there any ice blocked within the ice maker bucket or ice chute?</li> <li>• Is the water pressure less than 30 psi? Install a booster pump to compensate for the low pressure.</li> <li>•Is the freezer temperature too warm? Try setting the freezer temperature lower.</li> <li>•Whether the quantity supplied is larger than the quantity supplied? Please wait for at least 90 minutes.</li> </ul>
Water dispenser is not functioning	<ul style="list-style-type: none"> <li>•Is the water line connected and the water valve open?</li> <li>•Has the water line been crushed or kinked? Make sure the water line is free and clear of any obstruction.</li> <li>•Is the water tank frozen because the refrigerator temperature is too low? Try selecting a warmer setting on the display panel.</li> <li>•Check if the filter is properly installed. If it is not properly installed, the water dispenser may not work.</li> </ul>
Hear water bubbling in the refrigerator	This is normal. The bubbling comes from the refrigerant coolant liquid circulating through the refrigerator.

## Disposal of the appliance

It is prohibited to dispose of this appliance as household waste.

### Packaging materials

Packaging materials with the recycle symbol are recyclable. Dispose of the packaging into a suitable waste collection container to recycle it.

### Before disposal of the appliance

1. Pull out the mains plug from the mains socket.
2. Cut off the power cord and discard with the mains plug

**Warning!** Refrigerators contain refrigerant and gases in the insulation. Refrigerant and gases must be disposed of professionally as they may cause eye injuries or ignition. Ensure that tubing of the refrigerant circuit is not damage prior to proper disposal.

<b>Correct Disposal of this product</b>	
	This symbol on the product or in its packing indicates that this product may not be treated as household waste. Instead, it should be taken to the appropriate waste collection point for the recycling of electrical and electronic

---

	<p>equipment. By ensuring this product is disposed of correctly, you will help prevent potential negative consequences for the environment and human health, which could otherwise be caused by the inappropriate waste handling of this product. For more detailed information about the recycling of this product, please contact your local council your household waste disposal service, or the shop where you purchased the product.</p>
---	--