

ADVANCED PROHEAT® PET

2009 SERIES

IMPORTANT SAFETY INSTRUCTIONS

READ ALL INSTRUCTIONS BEFORE USING YOUR DEEP CLEANER.

When using an electrical appliance, basic precautions should be observed, including the following.

WARNING

TO REDUCE THE RISK OF FIRE, ELECTRIC SHOCK, OR INJURY:

- » Unplug from electrical socket when not in use and before cleaning, maintaining or servicing the appliance.
- » This appliance can be used by children aged from 8 years and above and persons with reduced physical, sensory or mental capabilities or lack of experience and knowledge if they have been given supervision or instruction concerning use of the appliance in a safe way and understand the hazards involved. Cleaning and user maintenance shall not be made by children without supervision.
- » Children should be supervised to ensure that they do not play with the appliance.
- » If the supply cable is damaged, it must be replaced by the manufacturer, its service agent or similarly qualified persons in order to avoid a hazard.
- » Do not run appliance over cable.
- » Keep hair, loose clothing, fingers, and all parts of body away from openings and moving parts of the appliance and its accessories.
- » Use only the type and amount of liquids specified under the Operations section of this guide.
 - » Do not leave appliance when plugged in.
 - » Always connect to a properly earthed electrical socket. Do not modify earthed plug.
 - » Use indoors only.
 - » Do not allow to be used as a toy.
 - » Use only as described in the user guide.
 - » Use only manufacturer's recommended attachments.
 - » Do not use with damaged cable or plug.
 - » Do not immerse in water or liquid.
- » If appliance is not working as it should, has been dropped, damaged, left outdoors, or dropped into water; do not attempt to operate it and have it repaired at an authorized service center.
- » Liquid or steam must not be directed towards equipment containing electrical components.
- » Do not pull or carry by cable, use cable as a handle, close door on cable, or pull cable around sharp edges or corners.
- » Keep cable away from heated surfaces.
- » Do not unplug by pulling on cable.
- » To unplug, grasp the plug, not the cable.
- » Do not handle plug or appliance with wet hands.
- » Do not put any object into openings.
- » Do not use with any opening blocked; keep free of dust, lint, hair, and anything that may reduce air flow.
- » Turn off all controls before unplugging.
- » Use extra care when cleaning on stairs.
- » Do not use to pick up flammable or combustible liquids, such as petrol, or use in areas where they may be present.
- » Do not pick up toxic material (chlorine bleach, ammonia, drain cleaner, etc.)
- » Do not use appliance in an enclosed space filled with vapors given off by oil base paint, some mothproofing substances, flammable dust, or other explosive or toxic vapors.
- » Do not pick up hard or sharp objects such as glass, nails, screws, coins, etc.
- » Keep appliance on a level surface.
- » Do not carry appliance while in use.
- » Unplug before attaching the TurboBrush™ tool.
- » If your appliance is fitted with a nonrewireable BS 1363 plug it must not be used unless a 13 amp (ASTA approved to BS 1362) fuse is fitted in the carrier contained in the plug. Spares may be obtained from your BISSELL supplier. If for any reason the plug is cut off, it must be disposed of, as it is an electric shock hazard should it be inserted into a 13 amp socket.

WARNING

TO REDUCE THE RISK OF FIRE AND ELECTRIC SHOCK, USE INDOORS ONLY . DO NOT IMMERSE. USE ONLY ON SURFACES MOISTENED BY THE CLEANING PROCESS. USE ONLY BISSELL CLEANING PRODUCTS INTENDED FOR USE WITH THIS MACHINE.

WARNING

TO REDUCE THE RISK OF FIRE AND ELECTRIC SHOCK, ALWAYS INSTALL FLOAT BEFORE ANY WET PICK-UP OPERATION.

SAVE THESE INSTRUCTIONS

FOR OPERATION ON A 220-240 VOLT A.C. 50/60 HZ POWER SUPPLY ONLY.

This model is for household use only.

Thanks for buying a BISSELL deep cleaner

We're glad you purchased a BISSELL deep cleaner. Everything we know about floor care went into the design and construction of this complete, high-tech home cleaning system.

Your BISSELL deep cleaner is well made, and we back it with a limited five-year guarantee. We also stand behind it with a knowledgeable, dedicated Consumer Care department, so, should you ever have a problem, you'll receive fast, considerate assistance.

My great-grandfather invented the floor sweeper in 1876. Today, BISSELL is a global leader in the design, manufacture, and service of high quality homecare products like your BISSELL deep cleaner.

Thanks again, from all of us at BISSELL.

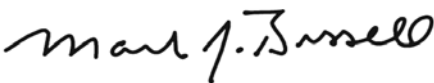





Mark J. Bissell
Chairman & CEO

Safety Instructions	2
Product View	4
Assembly	5
Operations	6-11
Maintenance & Care	12-14
Troubleshooting	15
Guarantee	16
Consumer Care	16

TIPS

- » Deep cleaning stairs and high-traffic areas on a regular basis helps prolong carpet life.
- » Deep cleaning carpeting regularly can reduce dust and allergens in your home.

	WARNING	AN ACTION OR ATTENTION IS NEEDED TO THIS AREA IN ORDER TO REDUCE THE RISK OF ELECTRIC SHOCK, FIRE, OR INJURY
	GUIDE	READ USER GUIDE FOR COMPLETE SAFETY AND USER INSTRUCTIONS
 	WEEE	DO NOT THROW THE APPLIANCE AWAY WITH THE NORMAL HOUSEHOLD WASTE AT THE END OF ITS LIFE, BUT HAND IT IN AT AN OFFICIAL COLLECTION POINT FOR RECYCLING. BY DOING THIS YOU WILL HELP TO PRESERVE THE ENVIRONMENT.

Product View



- 1 Spray Trigger
- 2 Cleaning Tools
(tools vary by model)
- 3 Upper Handle
- 4 Power Cord
- 5 Carry Handle
- 6 Ready Tools™ Dial

- 7 Removable Nozzle
- 8 DirtLifter™ PowerBrush
- 9 EdgeSweep™ Brushes
- 10 Belt Access Door
(underside of machine)
- 11 Cord Clip
- 12 Quick Release™ Cord Wrap

- 13 Hose
- 14 Tank Carry Handle
- 15 Tank Latch
- 16 2-in-1 Water Tank
- 17 Power Pedal (red pedal)
- 18 Recline Pedal

Assembly

Your deep cleaner comes in four easy-to-assemble components:

Upper Handle with Screws

Lower Base

Upper Hose/Cord Rack

Lower Hose/Cord Rack

The only tool you will need to assemble your cleaner is a Phillips head screwdriver.

1. Slide upper handle onto lower base and secure with two long screws into marked holes (screws will be taped to upper handle).

2. Attach upper hose/cord rack to back of the handle by guiding hook up into the slot location and pressing firmly upward until it is seated flush with back of machine. Secure 1 short screw through hole in the bottom of upper hose/cord rack.

3. Attach lower hose/cord rack by guiding the hook up into slot location and pressing firmly upward until it is seated flush with back of machine. Secure 2 short screws through holes on sides of the bottom hose/cord rack.

4. Wrap hose around lower and upper hose/cord racks and secure it by inserting trigger on hose grip into opening on hose grip holder located on upper hose/cord rack.

NOTE: Make sure to wrap hose beginning from back of bottom hose/cord rack and then wrapping over and around top of upper hose/cord rack.

5. Wrap cord around lower and upper hose/cord racks and secure plug to cord with clip on plug.

6. Attach cleaning tools as necessary to storage locations on front of cleaner, bottom hose/cord wrap and end of hose grip.

Deep cleaner assembly is now complete.

WARNING

Do not plug in your deep cleaner until you have completely assembled it per the instructions and are familiar with all instructions and operating procedures.

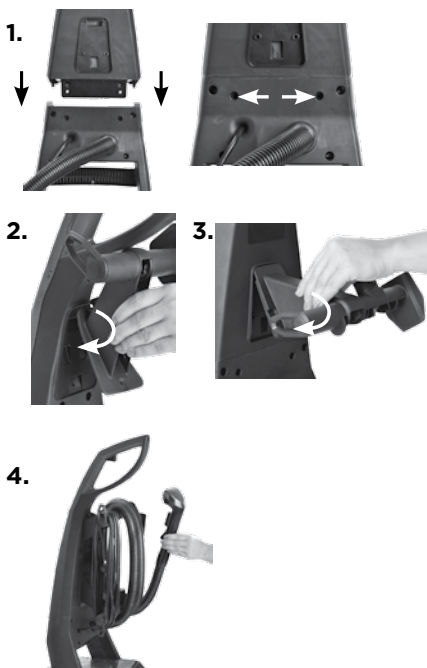

Operations

Cleaning Fluid

Keep plenty of genuine BISSELL 2X formula on hand so you can clean and protect whenever it fits your schedule. Always use genuine BISSELL deep cleaning formulas. Non-BISSELL cleaning solutions may harm the machine and may void the guarantee.

⚠️ WARNING

To reduce the risk of fire and electric shock due to internal component damage, use only BISSELL cleaning fluids intended for use with the deep cleaner.



650 mL Stain
Pretreat
#1147E



650 mL Pet Stain
Pretreat
#1137E



1.5 L 2X Wash & Protect PRO
Professional Stain & Odour
Formula w/ Scotchgard Protector
#1089E



1.5 L 2X Wash & Protect PET
Pet Stain & Odour Formula
w/ Scotchgard Protector
#1087E



1.5 L 2X Wash & Protect
Stain & Odour Formula w/
Scotchgard Protector
#1086E



1.5L 2X Wash & Remove OXY
Deep Clean + Oxy Formula
#1265E



1.5 L 2X Wash & Refresh Blossom
& Breeze Fragrance Formula w/
Febreze® Freshness
#1078E



1.5 L 2X Wash & Refresh
Cotton Fresh Formula w/
Febreze® Freshness
#1079E



1.5 L 2X Wash & Refresh
Natural Orange Formula
#1146E

Operations

Special features

Heatwave Technology™

This deep cleaner features Heatwave Technology that helps to maintain the temperature of the hand hot tap water you put in it to provide constant heat as you clean. The Heatwave Technology automatically turns on when you turn the machine on.

Before you clean

1. Plan activities to give your carpet time to dry.
2. Move furniture to another area if cleaning an entire room (optional).
3. Vacuum area with a dry vacuum cleaner before deep cleaning.
4. Plan your cleaning route to leave an exit path. It is best to begin cleaning in the corner farthest from your exit.

5. Pretreating (optional)

Pretreating is recommended to improve cleaning effectiveness for heavily soiled carpet in high traffic areas such as entry ways and hallways.

To pretreat:

- a. Using BISSELL Stain Pretreat (sold separately), generously spray evenly over soiled area, do not overwet.
- b. Wait 3-5 minutes before deep cleaning.
- c. Clean as normal using your BISSELL deep cleaner, following instructions in this guide.

WARNING

To reduce the risk of fire, use only BISSELL deep cleaning formula for full size machines in your deep cleaner. Use of cleaning formulas that contain lemon or pine oil may damage this appliance and void the guarantee. Chemical spot cleaners or solvent-based soil removers should not be used. These products may react with the plastic materials used in your deep cleaner causing cracking or pitting.

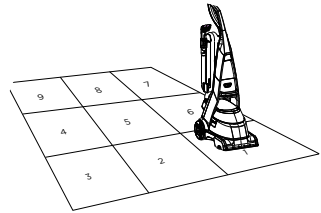

5a.



Operations

Filling the 2-in-1 water tank

1. Remove tank from base of machine by lifting tank carry handle. Carry like a bucket to the sink.
2. Pull upward on bottom edge of latch in the back of tank to unhook and remove lid.
3. Pull up on bladder fill cover that says "Fill Here". Fill the bladder with hand hot (60°C/140°F MAX) tap water. **Do not boil or microwave water as it can destroy the bladder.**
4. Using measuring cup provided, fill to indicated fill line on measuring cup and pour in to bladder.

NOTE: Always use genuine BISSELL 2X formulas to maximize cleaning and for the safety of your machine.

5. Replace tank lid by seating front edge of tank before back, then lock latch in place.

NOTE: Remember to secure lid and test to make sure it is secure before picking up tank.

6. Place tank into machine base, seating firmly in place.

WARNING

To reduce the risk of fire and electric shock due to internal component damage, use only BISSELL cleaning fluids intended for use with the deep cleaner. Non-BISSELL cleaning solutions may harm the machine and may void the guarantee.

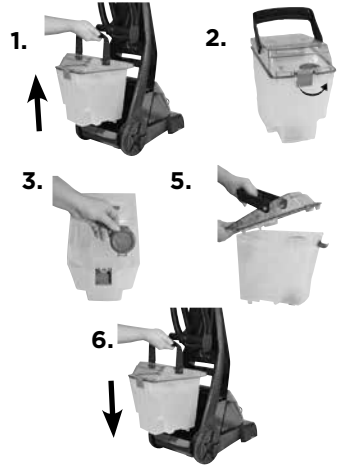

Carpets cleaning

1. Plug into a proper outlet. Set ReadyTools dial to Floor Cleaning setting. Turn power on by pressing red power pedal ① on back of machine with your foot.
2. With your foot, press gray recline pedal located on back of machine next to red power pedal.
3. While pressing spray trigger, make one slow forward wet pass and another back. **Caution: do not overwet.**
4. Release spray trigger and make one slow forward and backward pass over same area.
5. Repeat cleaning passes until solution being suctioned up appears clean. Continue passes without pressing spray trigger until you can't see any more water being suctioned up. Repeated passes will help aid in dry time.

NOTE: You may notice hair and debris deposits on the carpet or in the tank that were loosened by the cleaning action. This debris should be picked up and thrown away.

CAUTION

Take care not to run over loose objects or edges of area rugs. Stalling the brush may result in premature belt failure.

ATTENTION

Some Berber carpets have a tendency to fuzz with wear. Repeated strokes in the same area with an ordinary vacuum or deep cleaner may aggravate this condition.

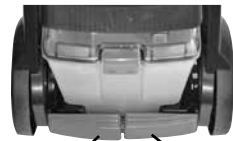

Power Pedal ①

Recline Pedal

Operations

Empty the 2-in-1 water tank/ clean removable nozzle

1. Press power pedal ① off. Remove 2-in-1 water tank from base using tank carry handle. Carry tank like a bucket to a utility sink or outside where you will dispose of dirty water.
2. Pull upward on bottom edge of latch in the back of tank to unhook and remove lid.
3. Empty dirty water from back corner of tank.
4. After each use, remove any debris trapped in red lint screen on base of machine while tank is still removed.
5. After each use, remove nozzle by grasping each side of top of nozzle and pulling forward.
6. When finished, replace nozzle by slightly raising front of machine to line up slots on each side of the base with hooks on each side of nozzle. Attach at base first and then push forward to click nozzle into place.

NOTE: If nozzle is not attached properly, loss of suction will occur.

7. To continue carpet cleaning, refer back to "Carpet cleaning" instructions on page 8.

If cleaning is complete, refer to "Maintenance and care" section starting on page 12.

WARNING

To reduce the risk of electric shock, push power button ① off and disconnect plug from electrical outlet before performing maintenance or troubleshooting checks.

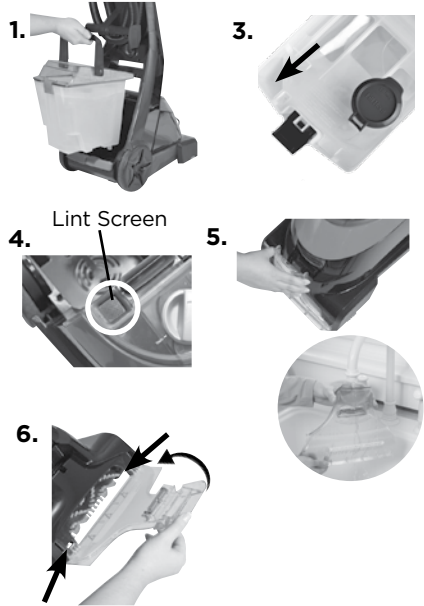

Ready Tools™

Your deep cleaner comes equipped with a hose and at least one cleaning tool for cleaning stairs, upholstery, and more.

Important! If using to clean upholstery, check upholstery tags.

1. Check manufacturer's tag before cleaning. "W" or "WS" on the tag means you can use your deep cleaner. If tag is coded with "X" or "S" (with a diagonal strike through), or says "Dry Clean Only," do not proceed with any deep cleaning machine. Do not use on velvet or silk. If manufacturer's tag is missing or not coded, check with your furniture dealer.
2. Check for colourfastness in an inconspicuous place.
3. If possible, check upholstery stuffing. Coloured stuffing may bleed through fabric when wet.
4. Plan activities to give upholstery time to dry.
5. Vacuum thoroughly to pick up loose debris and pet hair. Use a vacuum with a brush attachment and a crevice tool to clean in fabric folds and tufts.

IMPORTANT

Check for colourfastness in an inconspicuous place. If possible, check upholstery stuffing. Coloured stuffing may bleed through fabric when it becomes wet.

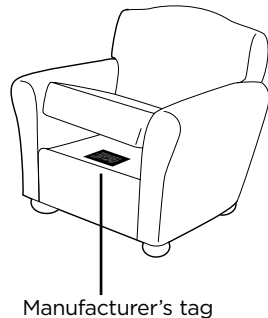

Operations

6. To begin cleaning with attachments, follow instructions on page 8 for filling 2-in-1 water tank.

7. Set ReadyTools dial to TOOLS setting. This will allow spray and suction from hose.

8. Attach cleaning tool of your choice to end of hose. If using a Pet Stain tool or 3-in-1 Upholstery and Stair tool, follow directions below.

9. Hold tool approximately 2.5 cm above soiled surface. Press spray trigger to apply cleaning solution to soiled area. Using brush on tool, gently scrub area to be cleaned. Release spray trigger, apply downward pressure on tool and pull it toward you to suction up dirt and cleaning solution. Continue until no more dirt can be removed. **Caution: Do Not Overwet.**

10. When finished cleaning, remove and rinse tool(s) in clean, running water.

11. It is recommended that you suction clean water from the tap to rinse out the hose. Be careful not to over-fill your tank.

12. Before wrapping hose onto rack, lift end of hose and stretch out to ensure all water is cleared from hose.

13. Wrap hose around rack.

14. Empty 2-in-1 water tank and rinse out, following instructions on page 9.

15. If ReadyTools dial becomes difficult to turn, the diverter assembly that holds dial may need to be cleaned. To clean, first remove nozzle and locate screw that holds diverter assembly in place. With a Phillips screwdriver, remove the screw and set aside.

16. Remove diverter assembly; hold under running water making sure water flows through and around dial. Turn dial about 10 times clockwise and 10 more times counter clockwise. This should free up any debris.

17. Wipe diverter assembly with a soft cloth and replace back on machine. Replace nozzle.

18. Return ReadyTools dial to FLOOR CLEANING setting.



Operations

Cleaning with Pet Stain Tool

1. Set tool on soiled surfaces and press spray trigger to spray solution onto soiled area to be cleaned.
2. Slowly move tool back and forth over soiled surface, keeping tool in contact with carpet.
3. Release spray trigger and move tool slowly over soiled area to suction up water and dirt.
4. Continue to clean the area, working in small sections, until no more dirt can be removed.
5. The front nozzle of the Pet Stain Tool can be removed for easy cleaning. Push the button at the top of the cleaning tool and slide the front nozzle off the top of the cleaning tool. Rinse the front nozzle and the tool with clean water and replace front nozzle back onto the tool.

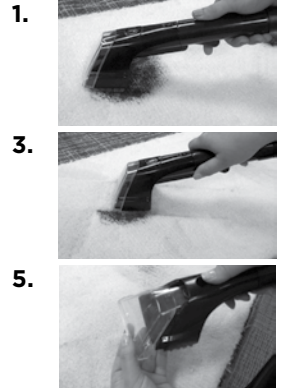

Cleaning with 3-in-1 Stair & Upholstery Tool

This versatile 3-way tool sprays, scrubs, and suctions up dirt and stains from upholstery and the outer curves, corner, and tread of carpeted stairs.

1. Attach the tool to the end of the hose. (You will hear a click when it is properly attached.)
2. Press the power button to turn on the cleaner.
3. Twist the tool head to desired setting to clean carpeted stairs. The downward facing edge is the active cleaning mode.
 - a. Use the flat area to clean top of stairs
 - b. Use indented area to clean outer corner (nose) of stairs
 - c. Use pointed edge to clean inside crevice
4. Ensure the tool spray tip is pointing downward. Pressing the spray trigger, slowly move the tool back and forth over the soiled surface keeping the tool in contact with the carpet.
5. Release spray trigger and move tool slowly over the soiled area to suction up water and dirt.
6. Continue to clean the area until no more dirt can be removed.
7. After use, tool can be easily cleaned by removing the front faceplate. Rinse out tool before storing.

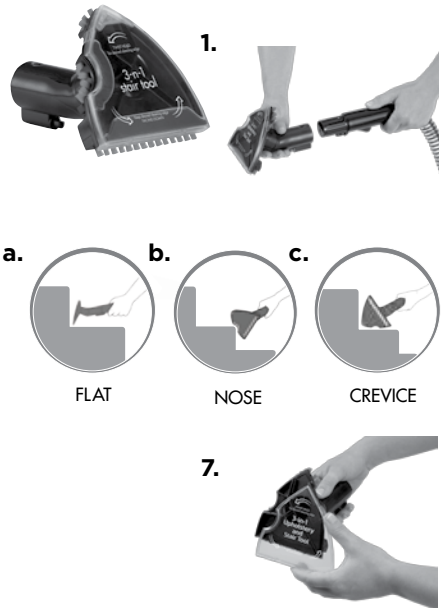

Maintenance & Care

Machine care

For best results, a few simple steps can assure your machine is well maintained after cleaning is complete.

1. Flush your machine of any remaining residual solution.
 - a. Fill 2-in-1 water tank with clean hand hot (60°C/140°F MAX) tap water.
 - b. Recline handle and press spray trigger for 15 seconds while making forward and backward passes on the carpet. Release spray trigger and make forward and backward passes for another 15 seconds or until there is no more water being suctioned up from carpet.
2. Press power pedal  off. Unplug machine and wrap power cord.
3. After emptying 2-in-1 water tank, rinse it with running hand hot (60°C/140°F MAX) tap water, taking care to clean underneath and around heavy duty bladder. Clean out red lint screen prior to replacing tank. Removable nozzle may be rinsed if necessary.
4. Replace 2-in-1 water tank on machine.
5. Any loose hair or debris can be pulled from brush roll and thrown away. See instructions on page 13 on removing brush roll.
6. Clean the ReadyTools dial assembly area by following the instructions in Step 15 and 16 on page 10.
7. To clean attachments, remove from hose and rinse under clean, running water. Dry before storing. Clean hose by suctioning clean water from tap (taking care not to let tank overflow). Before wrapping back on machine, lift end of hose and stretch out to ensure all water is cleared from hose. Refer to page 10, illustrations 11 and 12.
8. Wipe machine's exterior with a soft cloth.
9. After carpet is dry, you may wish to vacuum again to remove any leftover hair and fuzz the deep cleaner may have brought to the carpet surface.

WARNING

To reduce the risk of electric shock, push power button  off and disconnect plug from electrical outlet before performing maintenance or troubleshooting checks.

Tip

» Let all parts dry completely before storing

Maintenance & Care

Machine storage

Put unit away in a closet or basement for next use. Store cleaner in a protected, dry area. Since this product uses water, it must not be stored where there is a danger of freezing. Freezing will damage internal components and void guarantee.

⚠ WARNING

To reduce the risk of electric shock, push power button
① off and disconnect plug from electrical outlet before performing maintenance or troubleshooting checks.

Brush belt and brush removal & replacement

Occasional replacement of the brush belt or brush may become necessary. If needed, please follow instructions below.

1. Turn off machine and unplug it from outlet. Wrap hose and cord on racks.
2. Remove 2-in-1 water tank and set aside.

3. IMPORTANT: Fully recline handle and turn unit upside down.

4. Locate guard wire and remove screw.

NOTE: Guard wire does not remove.

5. Locate red belt access door and remove two screws.

NOTE: The dark screw is a long machine screw and will take approximately 25 full turns to completely remove. The head of the screw will lift from the belt access door so that it can be easily removed.

6. Remove belt access door assembly from end of brush and set aside.

7. Remove brush belt. If worn or damaged, replace with new brush belt.

8. If necessary, the brush roll can be removed for cleaning or replacement. To remove, rotate the brush out of brush housing and pull brush off axle attached to remaining end cap. The remaining pivot arm can be removed by removing the screw (this will allow for full access to brush chamber for cleaning). Make sure "keyed" end of metal rod is aligned with slot in pivot arm before re-assembly. Replace brush on axle, cogged-side, last. You may need to rotate brush to allow it to slide all the way down the axle.

9. Reattach brush belt by installing onto toothed pump pulley and then onto toothed end of brush.

10. Reattach belt access door assembly to end of brush and rotate back into place. Replace screws.

11. Replace screw on guard wire.

NOTE: Do not over tighten screws.

If you have any questions or are having trouble removing, replacing or reinstalling your brush belt or brush, please call BISSELL Consumer Care.

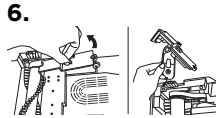
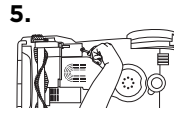
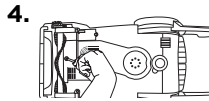
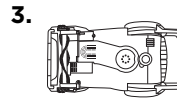
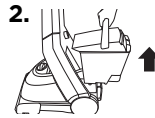

Maintenance & Care

Pump belt removal & replacement

Occasional replacement of the pump belt may become necessary. If needed, please follow instructions below.

1. Turn off machine and unplug it from outlet. Wrap hose and cord on racks.
2. Remove 2-in-1 water tanks and set aside.
3. **IMPORTANT: Fully recline handle and turn unit upside down.**
4. Locate guard wire and remove screw.

NOTE: Guard wire does not remove.

5. Locate red belt access door and remove two screws.

NOTE: The dark screw is a long machine screw and will take approximately 25 full turns to completely remove. The head of the screw will lift from the belt access door so that it can be easily removed.

6. Remove belt access door assembly from end of brush and set aside.
7. Remove brush belt from end of brush and set aside. If worn or damaged, replace with new brush belt.
8. Remove pump belt and replace it with a new belt by pinching belt at one end to make a large loop. Attach belt to silver motor shaft first and then pull towards larger, red pulley. Attach belt to red pulley.

NOTE: Spinning the red pulley a few times will help center belt and ensure correct assembly.

9. Reattach brush belt by installing onto toothed pump pulley and then onto toothed end of brush.
10. Reattach belt access door assembly to end of brush and rotate back into place. Replace screws.

11. Replace screw on guard wire.

NOTE: Do not over tighten screws.

If you have any questions or are having trouble removing, replacing or reinstalling your brush belt, please call BISSELL Consumer Care.

⚠️ WARNING

To reduce the risk of electric shock, push power button
① off and disconnect plug from electrical outlet before performing maintenance or troubleshooting checks.

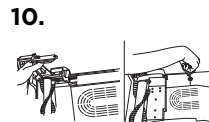
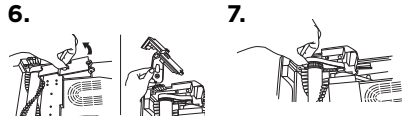
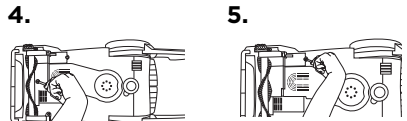
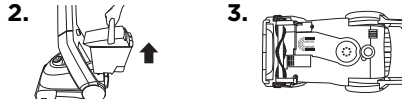

Troubleshooting

WARNING

To reduce the risk of electric shock, push power button ① off and disconnect plug from electrical outlet before performing maintenance or troubleshooting checks.

Problem	Possible causes	Remedies
Reduced spray OR no spray	Bladder may be empty.	Press power pedal ① off; refill bladder with clean hand hot (60°F/140°C MAX) tap water and formula.
	2-in-1 tank may not be seated properly.	Press power pedal ① off; remove tank and reseal tank.
	Pump may have lost prime.	Press power pedal ① off; after 1 minute turn on and depress spray trigger.
	Pump belt may be broken.	Press power pedal ① off and unplug from outlet. Follow belt replacement instructions on page 14.
DirtLifter PowerBrush does not turn	Brush belt or pump belt is off or broken.	Press power pedal ① off and unplug from outlet. Follow belt replacement instructions on pages 13 and 14.
Cleaner not picking up solution	ReadyTools dial may be on wrong setting for cleaning job.	Set ReadyTools dial to either floor cleaning or tools.
	Poor tool position. (Hand held attachments only).	Adjust angle; apply more downward pressure.
	Removable nozzle may not be properly attached.	Make sure nozzle is on correctly by slightly raising front of machine to line up slots on each side of base of machine with hooks on each side of nozzle. Attach at base first and then click nozzle into place. Refer to image 6 on page 9.
	2-in-1 tank lid is not properly installed.	Re-install lid; refer to images on page 9.
	2-in-1 tank is not properly seated.	2-in-1 tank must be firmly seated to function; remove and reseal 2-in-1 tank.
	2-in-1 tank has picked up maximum dirty water.	Empty 2-in-1 tank and refill, refer to the Operation section.
	The lint screen may be clogged.	Clean out lint screen, refer to page 9.

Please do not return this product to the store.

Other maintenance or service not included in the manual should be performed by an authorized service representative.

Thank you for selecting a BISSELL product.

Consumer Guarantee

This Guarantee only applies outside of the USA and Canada. It is provided by BISSELL International Trading Company BV ("BISSELL").

This Guarantee is provided by BISSELL. It gives you specific rights. It is offered as an additional benefit to your rights under law. You also have other rights under law which may vary from country to country. You can find out about your legal rights and remedies by contacting your local consumer advice service. Nothing in this Guarantee will replace or lessen any of your legal rights or remedies. If you need additional instruction regarding this Guarantee or have questions regarding what it may cover, please contact BISSELL Consumer Care or contact your local distributor.

This Guarantee is given to the original purchaser of the product from new and is not transferable. You must be able to evidence the date of purchase in order to claim under this Guarantee.

Limited Five-Year Guarantee

Subject to the *EXCEPTIONS AND EXCLUSIONS identified below, BISSELL will for five years from the date of purchase by the original purchaser repair or replace (with new or remanufactured components or products), at BISSELL's option, free of charge, any defective or malfunctioning part or product.

BISSELL recommends that the original packaging and evidence of the date of purchase be kept for the duration of the Guarantee period in case the need arises within the period to claim on the Guarantee. Keeping the original packaging will assist with any necessary re-packaging and transportation but is not a condition of the Guarantee.

If for your product is replaced by BISSELL under this Guarantee, the new item will benefit from the remainder of the term of this Guarantee (calculated from the date of the original purchase). The period of this Guarantee shall not be extended whether or not your product is repaired or replaced.

*EXCEPTIONS AND EXCLUSIONS FROM THE TERMS OF THE GUARANTEE

This Guarantee applies to products used for personal domestic use and not commercial or hire purposes. Consumable components such as filters, belts and mop pads, which must be replaced or serviced by the user from time to time, are not covered by this Guarantee.

This Guarantee does not apply to any defect arising from fair wear and tear. Damage or malfunction caused by the user or any third party whether as a result of accident, negligence, abuse, neglect, or any other use not in accordance with the User Guide is not covered by this Guarantee.

An unauthorised repair (or attempted repair) will void this Guarantee whether or not damage has been caused by that repair/attempt.

Removing or tampering with the Product Rating Label on the product or rendering it illegible will void this Guarantee.

SAVE AS SET OUT BELOW BISSELL AND ITS DISTRIBUTORS ARE NOT LIABLE FOR ANY LOSS OR DAMAGE THAT IS NOT FORESEEABLE OR FOR INCIDENTAL OR CONSEQUENTIAL DAMAGES OF ANY NATURE ASSOCIATED WITH THE USE OF THIS PRODUCT INCLUDING WITHOUT LIMITATION LOSS OF PROFIT, LOSS OF BUSINESS, BUSINESS INTERRUPTION, LOSS OF OPPORTUNITY, DISTRESS, INCONVENIENCE OR DISAPPOINTMENT. SAVE AS SET OUT BELOW BISSELL'S LIABILITY WILL NOT EXCEED THE PURCHASE PRICE OF THE PRODUCT.

BISSELL DOES NOT EXCLUDE OR LIMIT IN ANY WAY ITS LIABILITY FOR (A) DEATH OR PERSONAL INJURY CAUSED BY OUR NEGLIGENCE OR THE NEGLIGENCE OF OUR EMPLOYEES, AGENTS OR SUBCONTRACTORS; (B) FRAUD OR FRAUDULENT MISREPRESENTATION; (C) OR FOR ANY OTHER MATTER WHICH CANNOT BE EXCLUDED OR LIMITED UNDER LAW.

Consumer Care

If your BISSELL product should require service or to claim under our Limited Five-Year Guarantee, please contact us as follows:

Website:

www.BISSELL.com

Email:

UKSupport@bissell.com

Telephone:

0344-888-6644

Write:

BISSELL Homecare (Overseas) Inc.
Ground Floor
226 Berwick Avenue
Slough, Berkshire, SL1 4QT
United Kingdom

Spares are available for purchase.

To purchase visit www.4bissell.co.uk

Visit the BISSELL website: www.BISSELL.com

When contacting BISSELL, have model number of cleaner available.

Please record your Model Number: _____ Please record your Purchase Date: _____

NOTE: Please keep your original sales receipt. It provides proof of the date of purchase in the event of a Guarantee claim. See Guarantee for details.



©2016 BISSELL Homecare, Inc
Grand Rapids, Michigan
All rights reserved. Printed in China
Part Number 161-0136 08/16 RevA
Visit our website at: www.BISSELL.com

Scotchgard is a trademark of 3M.
Febreze is a trademark of The Proctor & Gamble Company, Cincinnati, Ohio used under license by BISSELL Homecare, Inc.