

Hisense

life reimagined

USER'S OPERATION MANUAL

Before operating this unit, please read this manual thoroughly, and retain for future reference

RL423N4AC1

English

Contents

Safety and warning information.....2	Using your appliance.....13
Installing your new appliance.....7	Helpful hints and tips.....14
Reversing the door.....8	Cleaning and care.....14
Description of the appliance.....10	Troubleshooting.....15
Display controls.....11	Disposal of the appliance.....17

CE This appliance is in accordance with the following EU guidelines: 2014/35/EU and 2014/30/EU and 2009/125/EC and EC.643/2009 and 2002/96/EC



Safety and warning information

For your safety and correct usage, before installing and first using the appliance, read this user manual carefully, including its hints and warnings. To avoid unnecessary mistakes and accidents, it is important to make sure that all people using the appliance are thoroughly familiar with its operation and safety features. Save these instructions and be sure that they remain with the appliance if it is moved or sold, so that anyone using it throughout its life, will be properly informed on its usage and safety notices. For the safety of life and property, keep the precautions of these user's

instructions as the manufacturer is not responsible for damages caused by omission.

Safety for children and others who are vulnerable people

- This appliance can be used by children aged from 8 years and above and persons with reduced physical, sensory or mental capabilities or lack of experience and knowledge if they have been given supervision or instruction concerning use of the appliance in a safe way and understand the hazards involved. Children shall not play with the appliance. Cleaning and user maintenance shall not be made by children without supervision.
- Keep all packaging away

from children as there is risk of suffocation.

- If you are discarding the appliance, pull the plug out of the socket, cut the connection cable (as close to the appliance as you can) and remove the door to prevent children playing from suffering an electric shock or from closing themselves inside it.

If this appliance, featuring a magnetic door seals, is to replace an older appliance having a spring lock (latch) on the door or lid, be sure to make the spring lock unusable

- before you discard the old appliance. This will prevent it from becoming a death trap for a child.

General safety



- **WARNING** — This appliance is intended

to be used in household and similar applications such as

- staff kitchen areas in shops, offices and other working environments;
- farm houses and by clients in hotels, motels and other residential type environments;
- bed and breakfast type

environments;

-catering and similar non-retail applications

- **WARNING** — Do not store explosive substances such as aerosol cans with a flammable propellant in this appliance.
- **WARNING** — If the supply cord is damaged, it must be replaced by the manufacturer, its service agent or similarly qualified persons in order to avoid a hazard.
- **WARNING** — Keep ventilation openings, in the appliance enclosure or in the built-in structure, clear of obstruction.
- **WARNING** — Do not use mechanical devices or other means to accelerate the defrosting process, other than those recommended by the manufacturer.
- **WARNING** — Do not damage the refrigerant circuit.
- **WARNING** — Do not use electrical appliances inside the food storage compartments of the appliance, unless they are of the type recommended by the manufacturer.

- **WARNING** — The refrigerant and insulation blowing gas are flammable. When disposing of the appliance, do so only at an authorized waste disposal centre. Do not expose to flame.

Refrigerant

The refrigerant isobutene (R600a) is contained within the refrigerant circuit of the appliance, a natural gas with a high level of environmental compatibility, which is nevertheless flammable. During transportation and installation of the appliance, ensure that none of the components of the refrigerant circuit becomes damaged.

The refrigerant (R600a) is flammable.



Caution: risk of fire

If the refrigerant circuit should be damaged:

- Avoid opening flames and sources of ignition.
- Thoroughly ventilate the room in which the appliance is situated.

It is dangerous to alter the specifications or modify this product in any way.

Any damage to the cord may cause a shortcircuit, fire, and/or electric shock.



Electrical safety

1. The power cord must not be lengthened.
2. Make sure that the power plug is not crushed or damaged. A crushed or damaged power plug may overheat and cause a fire.
3. Make sure that you can access the main plug of the appliance.
4. Do not pull the main cable.
5. If the power plug socket is loose, do not insert the power plug. There is a risk of electric shock or fire.
6. You must not operate the appliance without the interior lighting lamp cover.
7. The fridge is only applied with power supply of single phase alternating current of 220~240V/50Hz. If fluctuation of voltage in the district of user is so large that the voltage exceeds the above scope, for safety sake, be sure to apply A.C. Automatic voltage regulator of more than 350W to the fridge. The fridge must

employ a special power socket instead of common one with other electric appliances. Its plug must match the socket with ground wire.

Daily use

- Do not store flammable gass or liquids in the appliance, There is a risk of an explosion.
- Do not operate any electrical appliances in the appliance(e.g.electric ice cream makers,mixers etc.). When unplugging always pull the plug from the mains socket,do not pull on the cable.
- Do not place hot items near the plastic components of this appliance.
Store pre-packed frozen food in accordance with the frozen food manufacture's instructions. The appliances manufactures storage recommendations should be strictly adhered to.Refer to relrelevant instructions for storage.
- Frozen food can cause frost burns if consumed straight from the freezer compartment.
- Do not place the appliance in direct sunlight.
Keep buring candles,lamps and other items with naked flames away from the appliance so that do not set the appliance on fire.
- The appliance is intended for keeping food stuff and/or beverages in normal household as explained in this instruction booklet .
- The appliance is heavy.Care should be taken when moving it.
Do not remove nor touch items from the freezer compartment if your hands are damp/wet,as this could cause skin abrasions or frost/freezer burns.
Never use the base, drawers, doors etc. to stand on or as supports.
- To avoid items falling and causing injury or damage to the appliance, do not overload the door racks or put too much food in the crisper drawers.

caution!

Care and cleaning

- Before maintenance, switch off the appliance and disconnect the mains plug from the mains socket. Do not clean the appliance with metal objects, steam cleaner, ethereal oils, organic solvents or abrasive cleansers.
- Do not use sharp objects to remove frost from the appliance. Use a plastic scraper.

Installation Important!

- For electrical connection carefully, follow the instructions given in this manual.
- Unpack the appliance and check if there are damages on it. Do not connect the appliance if it is damaged. Report possible damages immediately to the place you bought it. In this case retain packing. It is advisable to wait at least four hours before connecting the appliance to allow the oil to flow back in the compressor. Adequate air circulation should be around the appliance, lacking this leads to overheating. To achieve

sufficient ventilation, follow the instructions relevant to installation. Wherever possible the back of the product should not be too close to a wall to avoid touching or catching warm parts (compressor, condenser) to prevent the risk of a fire, follow the instructions relevant to installation.

The appliance must not be locate close to radiators or cookers. Make sure that the mains plug is accessible after the installation of the appliance.

Service

- Any electrical work required to do the servicing of the appliance should be carried out by qualified electrician or competent person. This product must be serviced by an authorized Service Center, and only genuine spare parts must be used.
 - 1)If the appliance is Frost Free.
 - 2)If the appliance contains freezer compartment.

Installing your new appliance

Before using the appliance for the first time, you should be informed of the following tips.

Ventilation of appliance



In order to improve efficiency of the cooling system and save energy, it is necessary to maintain good ventilation around the appliance for the dissipation of heat. For this reason, sufficient clear space should be available around the refrigerator.

Suggest :It is advisable for there to be at least 75mm of space from the back to the wall, at least 100mm from its top, at least 100mm from its side to the wall and a clear space in front to allow the doors to open 135°. As shown in following figures.

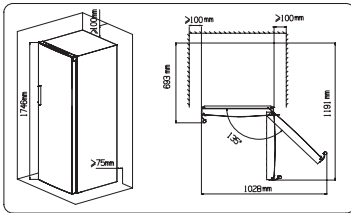

Note:

● This appliance performs well within the climate class from **SN to ST** showed in the table below.

It may not work properly if being left at a temperature above or below the indicated range for a long period.

Class	Symbol	Ambient Temperature range (°C)
Extended Temperate	SN	+10 to +32
Temperate	N	+16 to +32
Subtropical	ST	+16 to +38

- Stand your appliance in a dry place to avoid high moisture.
- Keep the appliance out of direct sunlight, rain or frost. Stand the appliance away from heat sources such as stoves, fires or heaters.

Leveling of appliance

● For sufficient leveling and air circulating in the lower rear section of the appliance, the bottom feet may need to be adjusted. You can adjust them manually by hand or by using a suitable spanner.

To allow the door to self-close, tilt the top backwards by about 10mm.



Installing the door handle

For the convenience of transportation, the door handles are separately provided in a plastic bag, you can install the door handles as follows.

1. Lever the screw hole covers on the side which you want to install the handle of the door, and then put them back to the plastic bag.
2. Take the handle match on the left side of the door as the example, keeping axes of screw holes in the handle and the door in a line, as the picture shows.

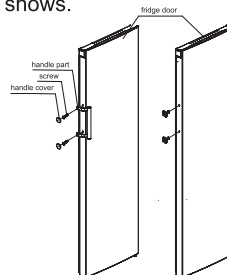





3. Fix the handle with the screws provided in the plastic bag. And then install the handle covers as the above figure shows.

Reversing the door

The side at which the door opens can be changed, from the right side (as supplied) to the left side, if the installation site requires.

Warning! When reversing the door, the appliance must not be connected to the mains. Ensure that the plug is removed from the mains socket.

Tools you will need:

	
8mm socket wrench	Cross-shaped screwdriver
	
Thin-blade screwdriver	8mm wrench

Note: Before you start lay the refrigerator on its back in order to gain access to the base, you should rest it on soft foam packaging or similar material to avoid damaging the backboard of the refrigerator. To reverse the door, the following steps are generally recommended.

1. Stand the refrigerator upright.

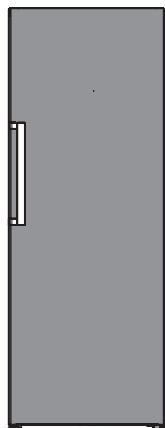

2. Remove part ① and part ② from the refrigerator body, and then take down part ③ on the door in the same way. Remove the part screws ④, then take off part ⑤ as the picture below.

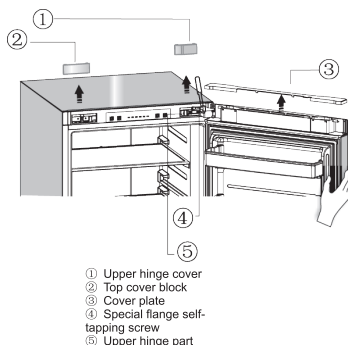

Note: Please hold the refrigerator door by hand during step 2 to prevent door dropping.

3. Take off the door ① and place it on smooth surface with panel upwards. Screw out the hinge axis ② (include washer) as show figure II and III, and then turn the upper hinge fixed board ③ over as show figure IV. Finally fix part ② on part ③ as show figure V and VI, then place it at side for use.

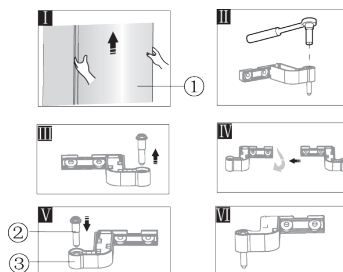

4. Lever handle covers ① and loose screws ②, remove the handle ③ as show figure I, then place it at side for use. Take the screw hole covers ④ down as show figure II, and install them in the left side as show figure III. Change handle to right, install it as show figure IV. Detach door stopper ⑤ and limit block ⑥ and then install door stopper and limit block to left as show figure V and VI.

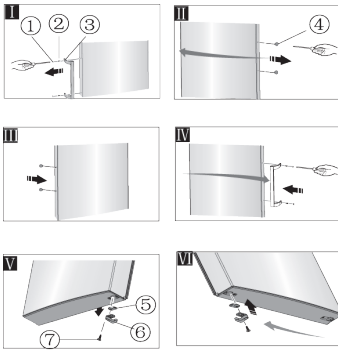

- ① Handle covers ② Screws
- ③ Handle ④ Screw hole covers
- ⑤ Door stopper ⑥ Limit block
- ⑦ Self-tapping screws

5. Place refrigerator flatwise, remove part ③ and then loose screws ④. Remove part ② and part ① as the picture.

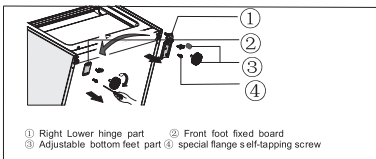

6. Screw out lower hinge axis, change it to the near hole site as the picture below, and then screw up and mount washer as the picture below.

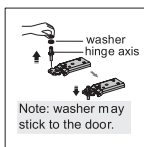

7. Just remount to the step 5, change part ① to left and part ② to right and then fix them with screws ④. Finally install part ③.

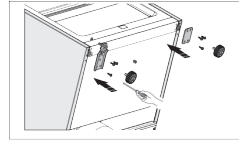

8. Take off the part ①, place it at side for use as show figure I. Move the refrigerator door to appropriate position adjust part ② and door, then fix part ② by screws as show figure II. (Please hold door by hand when installing). Fix the part ③ as show figure III (which is in the plastic bag). Reverse part ① by 180° and install it onto the right corner of the door as show figure IV. Finally mount part ④ as show figure V. (which was taken down in step 2)

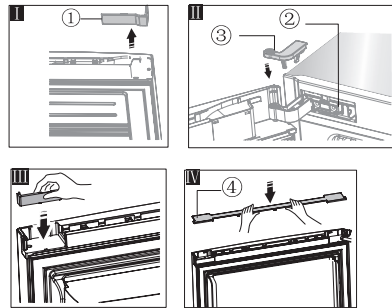

9. Finally install part ① and part ② (both of which are taken down in step 2) in the refrigerator body as the picture below.

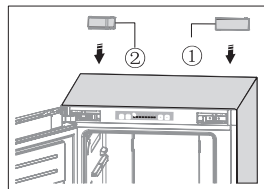

Description of the appliance

View of the appliance

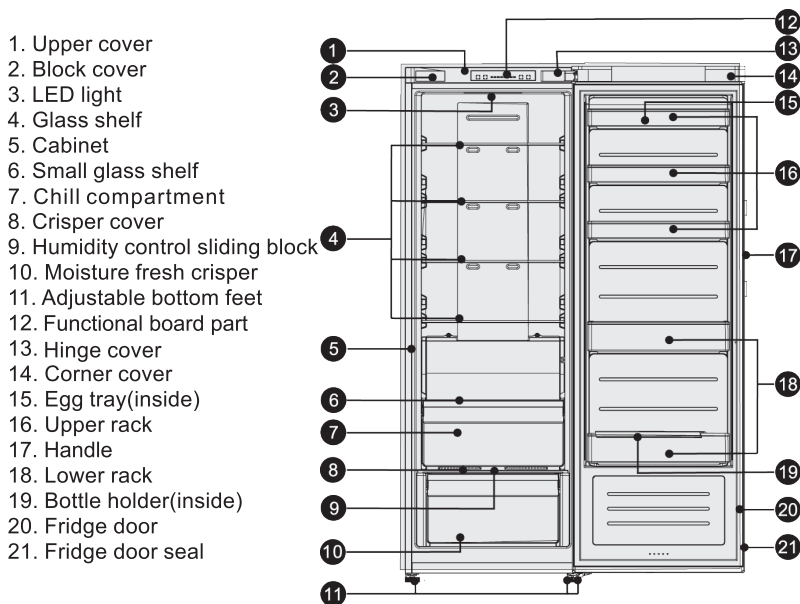

Product information

RS-42WL4SB1, RL423N4AW1, RL423N4AC1 : 220-240V~, 50Hz, R600a
 RL423N4ACU, RL423N4AWU, RS-42WL4SB : 220-240V~, 50Hz, R600a

Manufacturer and address as below

Hisense Ronshen (Guangdong) Refrigerator Co., Ltd.

Note: Due to constant improvement of our products, your refrigerator may be slightly different from this illustration manual, but its functions and using methods remain the same.

Note:To get the best energy efficiency of this product, please place all shelves, drawers and baskets on their original position as the illustration above.

Display controls

All functions and controls of the unit are accessible from a control panel conveniently located on the roof of the cabinet. A display circuit board allows easy configuration of features and settings in a simple and intuitive manner.

Important!

When the refrigerator is energized, all the pilot lights will turn on for 3 sec and you will also heard a long sound of "beep". The display board consists of four buttons and eight pilot lights. You will heard a short sound of "beep" when you press the button.

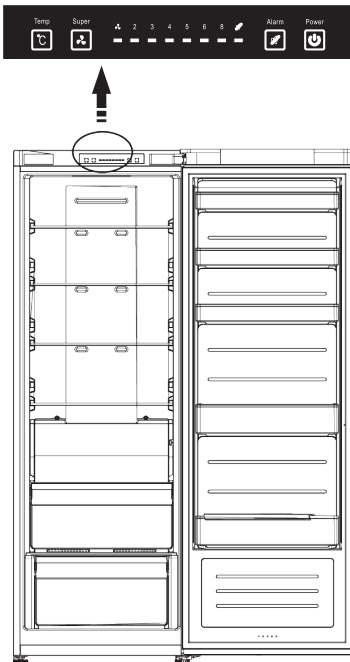

Controlling the temperature

To ensure the normal operation of the chill compartment, we recommend that when you start your refrigerator for the first time, the temperature for the refrigerator is set to 2°C or 3°C. If the function of chill compartment is not needed, we recommend that the temperature for the refrigerator is set to 5°C. If you want to change the temperature, follow the instructions below.

Caution! When you set a temperature, you set an average temperature for the whole refrigerator cabinet.

Temperatures inside the compartment may vary, depending on how much food you store and where you place it. High or low room temperature may also affect the actual temperature inside the

1. Temp



Press "Temp" button to set fridge temperature between 8°C and 2°C as needed,

and the light of the comparable temperature will be lightened corresponding values according to the following sequence.



2. Super



Super can refrigerate the food quicker and keep food fresh for a long period.

- Press "Super" button to activate the super cool function. The Super icon will light up and the fridge temperature indicator will display 2°C. Super cool automatically switches off after 6 hours.

- When super cool function is on, you can switch off super cool function by pressing “Super” or “Temp” button, then the fridge temperature setting or function mode will revert back to the previous setting.

3. Alarm



In case of alarm, “Alarm” icon will light up and a buzzing sound will start.

Press “Alarm” button to stop alarm and buzzing then “Alarm” icon will turn off.

Door Alarm

The alarm light on and a buzzing sound indicate abnormal conditions, such as accidentally a door left open.

- Leaving the door of refrigerator open for over 2 minutes will activate a door alarm and buzzer. The buzzer will beep 3 times per minute for 10 minutes. Closing the door cancels the door alarm and buzzer.
- To save energy, please avoid keeping the door open for a long time when using refrigerator.

4. Power



If you want to stop using it, you can turn the appliance off by pressing “Power” button.

- When the refrigerator is working, you can switch the appliance off by pressing “Power” button for above 5 seconds, meanwhile the display panel will be turned off.

Important! Do not store any food in the fridge during this time. If you will not use the refrigerator for a long time, please pull the plug.

- When the appliance is power off, you can switch the appliance on by pressing “Power” button for 1 second, and the refrigerator returns to the previous temperature setting.

Using your appliance

This section explains that how to use the refrigerator features. We recommend that you read through carefully before using the appliance.

Door rack

The refrigerator chamber is fitted with door racks suitable for storing canned liquid, bottled drinks and packed food. Do not place a large amount of heavy food and items inside door racks.

Note: There is an egg tray provided that should be located in the upper rack.

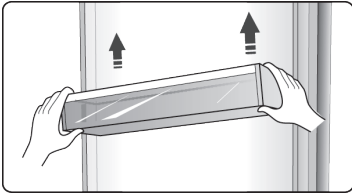

Shelf in Refrigerator chamber

● There are shelves in refrigerator chamber, and they can be taken out to be cleaned.

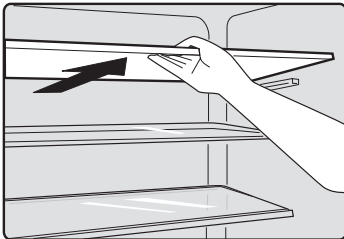

Chill compartment

● The temperature there is lower than that in the refrigerator chamber. To ensure the normal operation of the chill compartment, we recommend that the temperature for the refrigerator is set to 2°C or 3°C .

● It is used to store fish, meat and other erodible food.

Crisper cover

● It is for controlling the temperature of the crisper and avoiding the vegetable losing moisture.

Moisture fresh crisper

● It is suitable for the storage of fruits and vegetable.

Crisper and Humidity control

● The crisper is for storing vegetables and fruits. You can adjust the humidity inside by using the sliding block.

● The sliding block on crisper cover can slide to left or right and the air hole become more or less relatively. More air hole opening means less humidity and less means more humidity.

● We recommend that you store vegetables with more humidity and fruits less humidity.

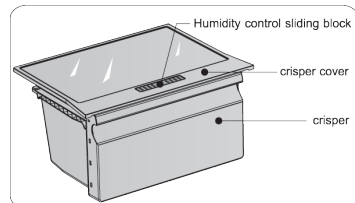

● When you remove the crisper, pull them forward, then lift the crisper off the roll wheels. Remember to empty food in the crisper firstly.

Bottle holder

The bottle holder can be used to fix the bottle.

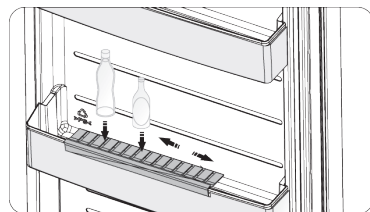

Note: There is a bottle holder in the lower rack.

Helpful hints and tips

Energy saving tips

We recommend that you follow the tips below to save energy.

- Try to avoid keeping the door open for long periods in order to conserve energy.
- Ensure the appliance is away from any sources of heat. (Direct sunlight, electric oven or cooker etc.)
- Don't set the temperature colder than necessary.
- Don't store warm food or evaporating liquid in the appliance.
- Place the appliance in a well ventilated, humidity free, room. Please refer to Installing your new appliance chapter.
- If the diagram shows the correct combination for the drawers, crisper and shelves, do not adjust the combination as this is designed to be the most energy efficient configuration.

Hints for fresh food refrigeration

- Do not place hot food directly into the refrigerator, the internal temperature will increase resulting in the compressor having to work harder and will consume more energy.
- Do cover or wrap the food, particularly if it has a strong flavor.
- Place food properly so that air can circulate freely around it.

Hints for refrigeration

- Meat (All Types) Wrap in polythene food: Wrap and place on the glass shelf above the vegetable drawer. Always follow food storage times and use by dates suggested by manufacturers.
- Cooked food, cold dishes, etc.: They should be covered and may be placed on any shelf.
- Fruit and vegetables: They should be stored in the special drawer provided.
- Butter and cheese: Should be wrapped in airtight foil or plastic film wrap.
- Milk bottles: Should have a lid and be stored in the door racks.

Switching off your appliance

If the appliance needs to be switched off for an extended period, the following steps should be taken prevent mould on the appliance.

1. Remove all food.
2. Remove the power plug from the mains socket.
3. Clean and dry the interior thoroughly.
4. Ensure that all the doors are wedged open slightly to allow air to circulate.

Cleaning and care

For hygienic reasons the appliance (including exterior and interior accessories) should be cleaned regularly at least every two months.

Caution! The appliance must not be connected to the mains during cleaning. Danger of electrical shock! Before cleaning switch the appliance off and remove the plug from the mains socket.

Exterior cleaning

To maintain good appearance of your appliance, you should clean it regularly.

- Wipe the digital panel and display panel with a clean, soft cloth.
- Spray water onto the cleaning cloth instead of spraying directly on the surface of the appliance. This helps ensure an even distribution of moisture to the surface.

-Clean the doors, handles and cabinet surfaces with a mild detergent and then wiped dry with a soft cloth.

Caution!

-Don't use sharp objects as they are likely to scratch the surface.

-Don't use Thinner, Car detergent, Clorox, ethereal oil, abrasive cleansers or organic solvent such as Benzene for cleaning. They may damage the surface of the appliance and may cause fire.

Interior cleaning

You should clean the appliance interior regularly. It will be easier to clean when food stocks are low. Wipe the inside of the fridge freezer with a weak solution of bicarbonate of soda, and then rinse with warm water using a wrung-out sponge or cloth. Wipe completely dry before replacing the shelves and baskets.

Thoroughly dry all surfaces and removable parts.

Although this appliance automatically defrosts, a layer of frost may occur on the freezer compartment's interior walls if the freezer door is opened frequently or kept open too long. If the frost is too thick, choose a time when the supply of food stocks are low and proceed as follows:

- 1.Remove existing food and accessories baskets, unplug the appliance from the mains power and appliance from the mains power and leave the doors open. Ventilate the room thoroughly to accelerate the

thawing process.

2. When defrosting is completed, clean your freezer as described above.

Caution! Don't use sharp objects to remove frost from the freezer compartment. Only after the interior is completely dry should the appliance be switched back on and plugged back into the mains socket.

Door seal cleaning

Take care to keep door seals clean. Sticky food and drinks can cause seals to stick to the cabinet and tear when you open the door. Wash seal with a mild detergent and warm water. Rinse and dry it thoroughly after cleaning.

Caution! Only after the door seals are completely dry should the appliance be powered on.

Replacing the LED light

Warning: The LED light must not be replaced by the user! If the LED light is damaged, contact the customer helpline for assistance. To replace the LED light, the below steps can be followed:

- 1.Unplug your appliance.
- 2.Remove light cover by pushing up and out.
- 3.Hold the LED cover with one hand and pull it with the other hand while pressing the connector latch.
- 4.Replace LED light and snap it correctly in place.

Troubleshooting

If you experience a problem with your appliance or are concerned that the appliance is not functioning correctly, you can carry out some easy checks before calling for service, please see below. You can carry out some easy checks according to this section before calling for service.

Warning! Don't try to repair the appliance yourself. If the problem persists after you have made the checks mentioned below, contact a qualified electrician, authorized service engineer or the shop where you purchased the product.

Problem	Possible cause & Solution
Appliance is not working correctly	Check whether the power cord is plugged into the power outlet properly.
	Check whether the "Power" function is on by pressing the "power" button for 1 second.
	Check the fuse or circuit of your power supply, replace if necessary.
	The ambient temperature is too low. Try setting the chamber temperature to a colder level to solve this problem.
	It is normal that the refrigerator is not operating during the automatic defrost cycle, or for a short time after the appliance is switched on to protect the compressor.
Odours from the compartments	The interior may need to be cleaned.
	Some food, containers or wrapping cause odours.
Noise from the appliance	<p>The sounds below are quite normal:</p> <ul style="list-style-type: none"> ● Compressor running noises. ● Air movement noise from the small fan motor in the fridge compartment or other compartments. ● Gurgling sound similar to water boiling. ● Popping noise during automatic defrosting. ● Clicking noise before the compressor starts.
	<p>Other unusual noises are due to the reasons below and may need you to check and take action:</p> <ul style="list-style-type: none"> ● The cabinet is not level. ● The back of appliance touches the wall. ● Bottles or containers fallen or rolling.
The motor runs continuously	<p>It is normal to frequently hear the sound of the motor, it will need to run more when in following circumstances:</p> <ul style="list-style-type: none"> ● Temperature setting is set colder than necessary ● Large quantity of warm food has recently been stored within the appliance. ● The temperature outside the appliance is too high. ● Doors are kept open too long or too often. ● After your installing the appliance or it has been switched off for a long time.
A layer of frost occurs in the compartment	Check that the air outlets are not blocked by food and ensure food is placed within the appliance to allow sufficient ventilation. Ensure that door is fully closed. To remove the frost, please refer to cleaning and care chapter.
Temperature inside is too warm	You may have left the doors open too long or too frequently; or the doors are kept open by some obstacle; or the appliance is located with insufficient clearance at the sides, back and top.

Temperature inside is too cold	Increase the temperature by following the Display controls chapter.
Doors can't be closed easily	Check whether the top of the refrigerator is tilted back by 10-15mm to allow the doors to self close, or if something inside is preventing the doors from closing.
Water drips on the floor	The water pan (located at the rear bottom of the cabinet) may not be properly leveled, or the draining spout (located underneath the top of the compressor depot) may not be properly positioned to direct water into this pan, or the water spout is blocked. You may need to pull the refrigerator away from the wall to check the pan and spout.
The light is not working	<ul style="list-style-type: none"> • The LED light may be damaged. Refer to replace LED lights in cleaning and care chapter. • The control system has disabled the lights due to the door being kept open too long, close and reopens the door to reactivate the lights.

Disposal of the appliance

It is prohibited to dispose of this appliance as household waste.

Packaging materials

Packaging materials with the recycle symbol are recyclable. Dispose of the packaging into a suitable waste collection container to recycle it.

Before disposal of the appliance

1. Pull out the mains plug from the mains socket.
2. Cut off the power cord and discard with the mains plug.

Warning! Refrigerators contain refrigerant and gases in the insulation. Refrigerant and gases must be disposed of professionally as they may cause eye injuries or ignition. Ensure that tubing of the refrigerant circuit is not damaged prior to proper disposal.

	Correct Disposal of this product
	<p>This symbol on the product or in its packing indicates that this product may not be treated as household waste. Instead, it should be taken to the appropriate waste collection point for the recycling of electrical and electronic equipment. By ensuring this product is disposed of correctly, you will help prevent potential negative consequences for the environment and human health, which could otherwise be caused by the inappropriate waste handling of this product. For more detailed information about the recycling of this product, please contact your local council your household waste disposal service, or the shop where you purchased the product.</p>

Hisense Service Help Line: 0844 3460087

Hisense Refrigerator

Hisense

life reimagined

Hisense UK Ltd
Unit 2 Meadow Court
Millshaw Lane
Leeds
LS11 8LZ