

1 Assembly

Warranty Information

Grey Technology has provided the SW02 Cordless Power Sweeper with a **12 month guarantee**.

In Guarantee:

Please retain your receipt as proof of purchase. In the rare and unfortunate event of your Gtech product being faulty, please accept our apologies and we will aim to remedy the problem as fast as possible once brought to our attention. However please be aware that due to Company Policy, Grey Technology can only repair or replace all or part of the product if proof of purchase is provided and the claim is made within 12 months of the purchase date.

If your product is within the 12 months warranty period you should either return this product with its receipt to the retailers where the product was purchased or if a simple part or advice is required ring the Gtech Helpline where we will be more than happy to assist.

Note: Gtech cannot refund any monies if the product was brought from a third party.
Note: The battery is a consumable item and is not covered by this guarantee.

We would like to remind our customers that the Gtech guarantee does not cover any unauthorised repairs and will be annulled:

- 1 if the product has been damaged due to incorrect use or maintenance.
- 2 if any part is modified or replaced or if it is used in any way that is not recommended by Gtech.
- 3 if it is used with any parts not produced or not recommended by Gtech.
- 4 if it is used for purposes other than those specified by Gtech.

If after reading the manual and following the instructions you are sure that the product is defective please call the **Gtech Helpline on 01905 345891**.

A Customer Service Advisor will be available to deal with any problems you have with our product. To assist them please be ready with the product, a detailed description of the problem, and your proof of purchase.

Out of Guarantee:

If your Gtech product is over 12 months old and you need any parts or advice then please contact our Helpline. Parts will be sent out usually within 3 weeks of request.

The  symbol indicates that this product is covered by legislation for waste electrical and electronic products (EN2002/96/EC)

When the sweeper has reached the end of its life, it and the NiMH battery it contains should not be disposed of with general household waste. The battery should be removed from the sweeper and both should then be disposed of properly at a recognised recycling facility.

WARNING: Only use the charger supplied with the product.

Call your local council, civic amenity site, or recycling centre for information on the disposal and recycling of electrical products. Alternatively visit www.recycle-more.co.uk for advice on recycling and to find your nearest recycling facilities.



03/05/11



Using another charger may damage the product and the battery and will invalidate your guarantee.

- 1 Do not store or charge the unit outdoors.
- 2 Do not use outdoors or on wet surfaces.
- 3 Do not handle the charger or appliance with wet hands.
- 4 Not to be used as a toy; pay close attention when used by or near children.
- 5 This appliance is not intended for use by persons (including children) with reduced physical, sensory or mental capabilities, or lack of experience and knowledge, unless they have been given supervision or instruction concerning use of the appliance by a person responsible for their safety.
- 6 Children should be supervised to ensure that they don't play with the appliance.
- 7 Use only as described in this manual.
- 8 Never modify the charger in any way.
- 9 Only use the charger supplied with the product. Do not attempt to use the charger with any other product nor attempt to charge this product with another charger. A charger may create a risk of fire when used with another battery pack.
- 10 Do not abuse the charger cord as this can increase the risk of fire or electric shock. Never carry the charger by the cord. Do not pull the cord to disconnect from a socket; grasp the plug and pull to disconnect.
- 11 Keep the charger cord away from hot surfaces and sharp edges.
- 12 Do not handle the charger with wet hands. The battery must be removed from the appliance before it is discarded.
- 13
- 14 Before use check the power supply and charger cord for signs of damage or ageing. To avoid damage it is not recommended to wrap the cord around the charger for storage. A damaged or entangled charger cord can increase the risk of fire and electric shock.
- 15 The appliance must be disconnected from the mains supply when removing the battery. This product includes NiMH batteries; do not incinerate batteries or expose to high temperatures, as they may explode. Leaks from battery cells can occur under extreme conditions. If the liquid gets on the skin wash immediately with soap and water. If the liquid gets into the eyes, flush them immediately with clean water for a minimum of 10 minutes and seek medical attention. Liquid ejected from the battery may cause irritation or burns. In an emergency situation contact professional help immediately!
- 18 Do not use with any opening blocked; keep openings free of dust, lint, hair and anything that may interfere with the brushes.
- 19 Keep hair, clothing, fingers, and all parts of body clear of moving parts.
- 20 Do not pick up anything that is flammable, burning or smoking.
- 21 Use extra care when cleaning on stairs.

WARNING: When using an electrical appliance basic safety precautions should always be observed, including the following to reduce the risk of fire; electrical shock, or injury:

-  Do not use in rain or leave outdoors whilst raining.
-  **IMPORTANT:** READ ALL INSTRUCTIONS BEFORE USE. RETAIN INSTRUCTIONS FOR FUTURE REFERENCE.

Important Safeguards

Gtech SW02

customer helpline
01905 345891
support@greytechnology.co.uk
www.gtechonline.co.uk

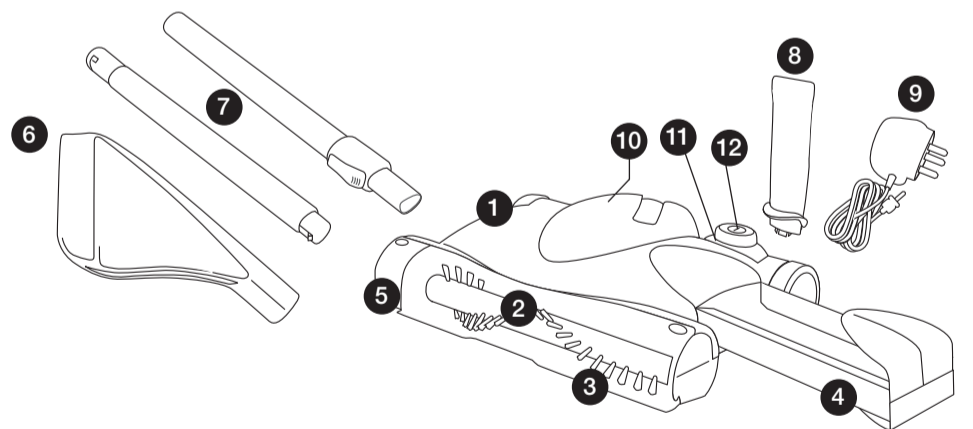

- | | |
|----------------|---|
| 1 Main Unit | 7 Telescopic Tubes |
| 2 Brush Bar | 8 Lower Handle* Packed inside dust tray |
| 3 Front Visor | 9 Charging Adaptor* Packed inside dust tray |
| 4 Dust Tray | 10 Charging Jack |
| 5 Edge Wheel | 11 LED Indicator |
| 6 Upper Handle | 12 ON/OFF button |

Technical specification

Unit operating cycle with full battery	up to 60 minutes (dependent on floor surface)
Battery type	7.2V DC 1.3Ah
Charging period for fully discharged battery	16 hours
Battery charger output	12.0V DC, 150mA
Battery charger model	JOD-S-120015BS
Sound level	75dB(A)
Weight	1.6Kg

WARNING: Only use a replacement battery as supplied by the manufacturer and only use the charger provided with the product. Using another charger may damage the product and battery.

2 Operation

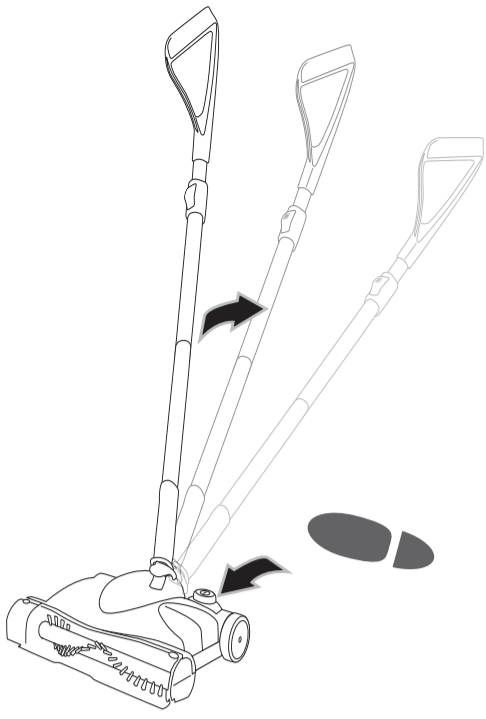

Floor Cleaning

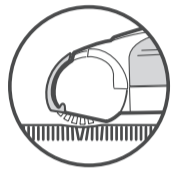

- 1 For normal cleaning push the sweeper flat over the floor.

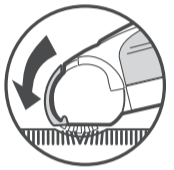

- 2 For deeper cleaning and carpet grooming, lift the Handle to lower the brush bar into the carpet.

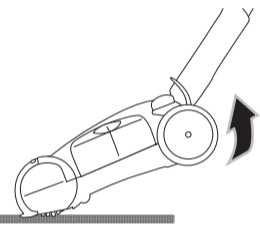

Handheld Operation and Stair Cleaning

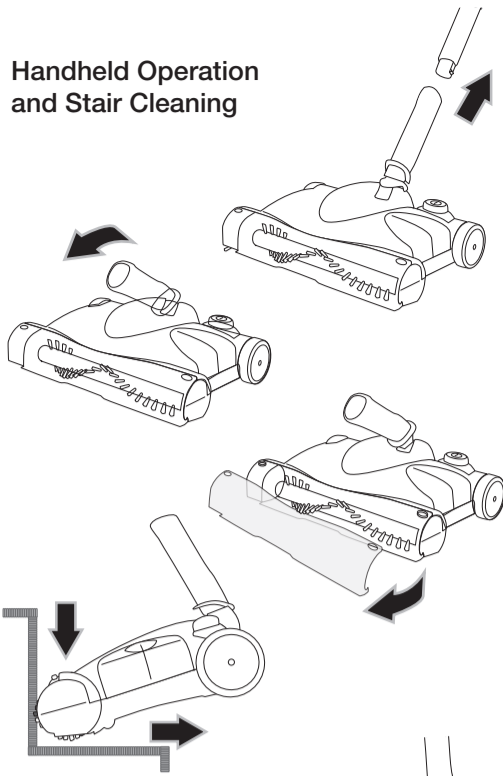

Carrying

To avoid spilling dirt from the Dust Tray do not carry the product 'nose down'.

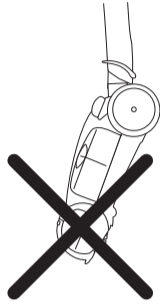

Bin Empty

To achieve the best performance, empty the Dust Tray after each use.

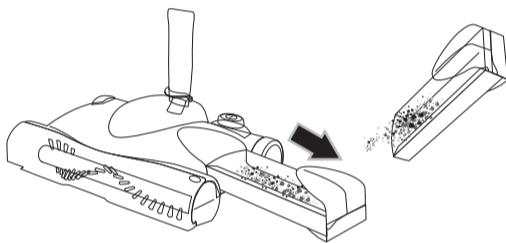

4 Care & Maintenance

WARNING: Do not accidentally turn the unit on while cleaning it.

Each week clean the product with a dry cloth, plus the chamber in which the Dust Tray fits. Remove hair and fibre from the Brush Bar and Edge Wheel.

- 1 Don't use abrasive materials to clean the product or immerse it in water.
- 2 Don't pick up liquids or use on wet floors.
- 3 Don't use on concrete, Tarmac or other rough surfaces.
- 4 Don't pick up pieces of string or fabrics with the unit.
- 5 Don't clean rug tassels or frayed carpets with the unit.

Brush Bar & Edge Wheel Removal

The Brush Bar and Edge Wheel can be removed for cleaning or replacement.

- 1 Push the latch and un-hook the Edge Wheel Cover from the front of the unit.
- 2 Slide the belt off the end of the Brush Bar drive gear.
- 3 Lift the end of the Brush Bar, then slide out of the unit.
- 4 The Edge Wheel Brush can be pushed out of the cover.
- 5 Remove any hair, fibre and dust from the Edge Wheel and Brush Bar.
- 6 Replace the Brush Bar by fitting the shaft into the bearing in the housing, then engage the end with the drive gear into the unit. **Note: peg to relocate into unit.**

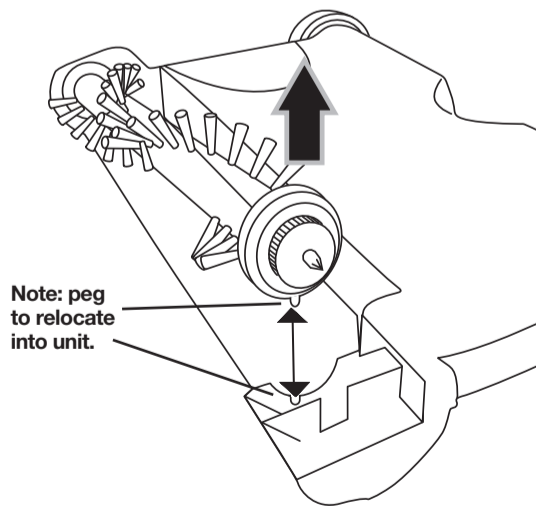
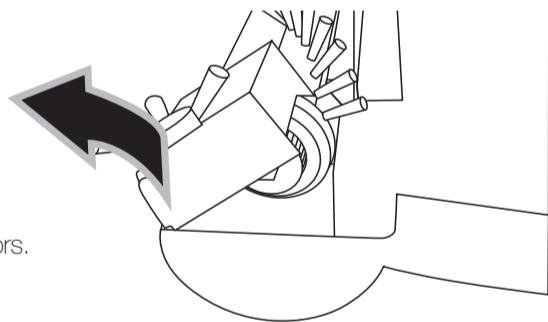

Product Is Not Working Properly?

- 1 Empty the Dust Tray.
- 2 Remove any build-up of hair or fibre from the Brush Bar and Edge Wheel.
- 3 Fully discharge the product (run until battery is flat) and then recharge for 16 hours.

3 Battery Charging & Recharging

- 1 Connect the Charging Adaptor to the Charging Jack on the rear of the Main Unit, and then plug into an electrical outlet. The LED illuminates RED when the charger is connected.
- 2 Charge the unit for at least 16 hours. Do not charge the product for longer than 24 hours.
- 3 Once the battery is fully charged switch off the charger at the mains socket, remove the charging jack from the battery pack, and unplug the charger from the mains socket. Do not pull the charger by the cord, grasp the charger and pull to disconnect.
- 4 Never run the battery empty and then put the product away without switching it off - deep discharge can damage the battery.

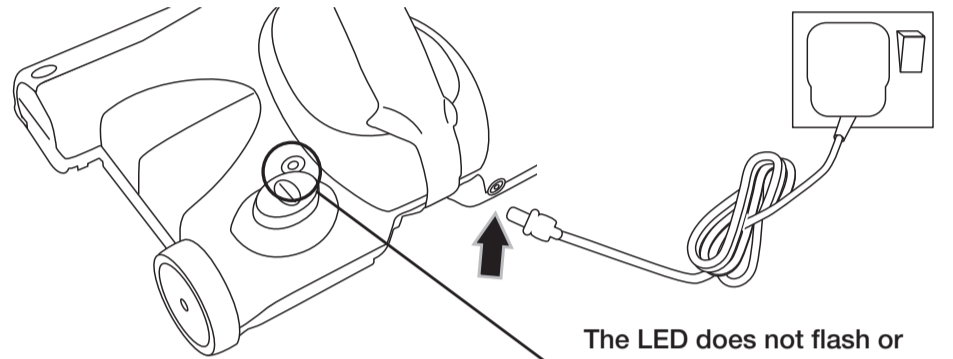

The LED does not flash or change colour when the unit is fully charged. The unit will only re-charge when the unit is switched off.

To maintain peak performance of your cordless sweeper, it is recommended that the unit be fully discharged, then completely recharged at least once a month.

5 Battery Pack Removal & Replacement

At the end of the product's or battery's life the battery should be removed for disposal and recycling. Only a technically competent person should undertake battery removal and replacement.

If uncertain as to how to replace your battery pack, we suggest you take your unit to a reputable small appliance service technician to have this service performed.

Follow these steps for battery removal or replacement:

- 1 Switch off the product and ensure the Charger is disconnected.
- 2 Remove the Telescopic Tubes and Dust Tray.
- 3 Turn the unit over, being careful not to switch the product on.
- 4 Press the clip to release the Battery Cover.
- 5 Carefully lift the battery out.
- 6 Slide the plastic cover off the black (-) cable connector.
- 7 Push the latch on the connector and pull the connector off the battery contact.
- 8 Repeat for the red (+) cable connector.
- 9 Push the cable connectors onto the new battery contacts, ensuring they are securely fitted.
- 10 Slide the plastic covers back over the connectors.
- 11 Replace the battery into the compartment and refit the battery cover.

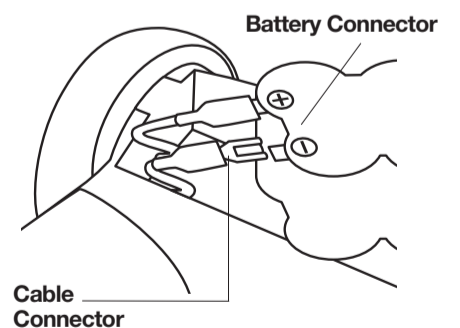
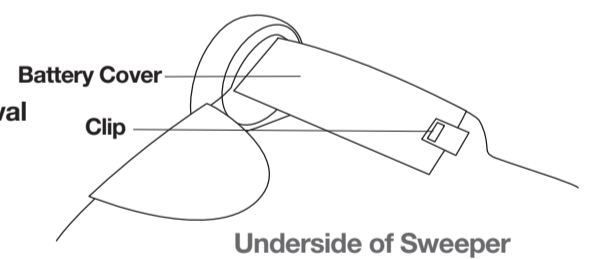

WARNING: NEVER touch both the metal battery contacts at the same time with any metal objects as this may create sparks that can cause small burns. NEVER use the unit in a partially assembled state.

ONLY USE A REPLACEMENT BATTERY AS SUPPLIED BY MANUFACTURER
Replacement batteries, Brush Bars and Edge Wheels can be purchased through the helpline Tel: 01905 345891 or by visiting www.gtechonline.co.uk