

THANK YOU FOR PURCHASING A HOTPOINT PRODUCT.

To receive more comprehensive assistance, register the appliance on www.hotpoint.co.uk/register



Before using the appliance carefully read the Health and Safety guide.

! Before using the machine, it is imperative that the transport bolts are removed. For more detailed instructions on how to remove them, see the Installation Guide.

CONTROL PANEL

1. ON/OFF button
2. TEMPERATURE knob
3. DRYING knob
4. WASH CYCLE PROGRESS indicator lights
5. DOOR LOCKED indicator light
6. START/PAUSE button and indicator light
7. FUNCTION buttons and indicator lights
8. WASH CYCLE SELECTOR KNOB

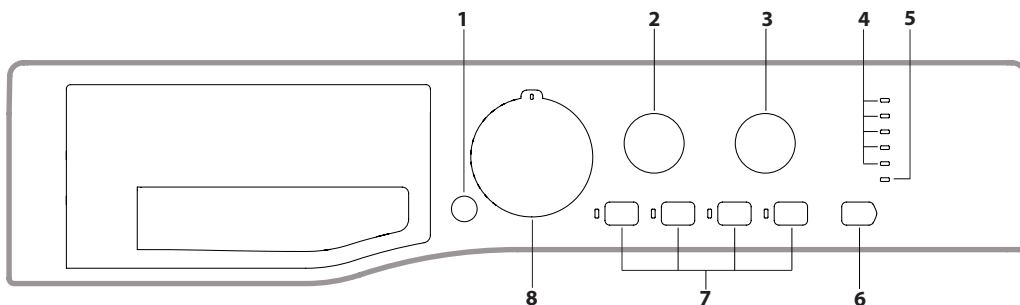

WASH CYCLE TABLE

Wash cycle		Temperature		Max. spin speed (rpm)	Max. load (kg)	Duration (minutes)	Drying	Detergents and Additives		Recommended detergent	
		Default	Range					Wash	Fabric softener	Powder	Liquid
1	2	3	4	5	6	7	8	9	10	11	12
1	Anti-Stain	40°C	☼ - 40°C	1400	5	185	●	●	○	-	✓
2	Anti-Stain Quick	40°C	☼ - 40°C	1200	4,5	60	●	●	○	-	✓
3	Whites	60°C	☼ - 90°C	1400	5	170	●	●	○	✓	✓
4	Cotton (2)	40°C	☼ - 60°C	1400	8	235	●	●	○	✓	✓
5	Eco Cotton (1)	60°C	☼ - 60°C	1400	8	225	●	●	○	✓	✓
6	Synthetics (3)	40°C	☼ - 60°C	1000	4,5	125	●	●	○	-	✓
7	Anti Allergy	60°C	☼ - 60°C	1400	5	210	●	●	○	✓	✓
8	Wool	40°C	☼ - 40°C	800	2	90	●	●	○	-	✓
9	Delicates	30°C	☼ - 30°C	0	1	80	●	●	○	-	✓
10	Fast Wash 30'	30°C	☼ - 30°C	800	3,5	30	-	●	○	-	✓
11	Wash & Dry 45'	30°C	☼ - 30°C	1400	1	45	●	●	○	-	✓
12	Drying Cotton	-	-	-	6	-	●	-	-	-	-
13	Drying Synthetics	-	-	-	4	-	●	-	-	-	-
14	Drying Wool	-	-	-	2	-	●	-	-	-	-
	Rinse	-	-	1400	8	50	●	-	○	-	-
	Spin+Pump out	-	-	1400	8	10	●	-	-	-	-

● Required dosage ○ Optional dosage

The cycle duration indicated on the display or instruction manual is an estimate based on standard conditions. The actual duration may vary in relation to several factors, such as the temperature and pressure of the incoming water, ambient temperature, amount of detergent, load quantity and type, load balancing and any additional options selected.

1) Test programme in compliance with standard EN 50229 (Wash):

This cycle is designed for normally soiled cotton loads and is the most efficient in terms of both electricity and water consumption; it should be used for garments washable at 60°C or at 40°C. The actual washing temperature may differ from the indicated value.

Test programme in compliance with standard EN 50229 (Drying): select the "Drying Cotton" programme and set the drying level to "1", for both loads. The first drying cycle must be carried out with the nominal load.

For all testing institutes:

- 2) Long cotton cycle: set wash cycle 4 with a temperature of 40°C.
- 3) Long synthetics cycle: set wash cycle 6 with a temperature of 40°C.

Fabric type	Load type	Max. load (kg)	Cupboard dry	Henger dry	Iron dry
Cotton	Clothing of different sizes, Terry towels	6	255	230	200
Synthetics	Sheets, Shirts, Pyjamas, socks, etc.	4	220	200	190
Wool	Knitwear, Pullovers, etc.	2	210	190	180

PRODUCT DESCRIPTION

1. Top
2. Detergent dispenser drawer
3. Control panel
4. Handle
5. Porthole door
6. Drain pump (behind the plinth)
7. Plinth (removable)
8. Adjustable feet (2)

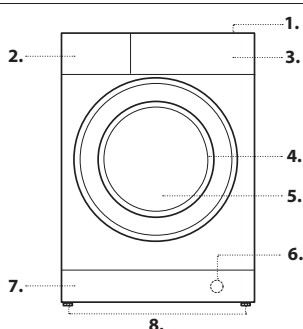

DETERGENT DISPENSER DRAWER

Compartment *:

Do not insert detergent in this compartment. **Compartment 1: Washing detergent (powder or liquid)**

If liquid detergent is used, the removable plastic partition A (supplied) should be used for proper dosage.

If powder detergent is used, place the partition into slot B.

Compartment 2: Additives (fabric softeners, etc.)

The fabric softener must not exceed the "MAX" level.

- ! Use powder detergent for white cotton garments, for pre-washing, and for washing at temperatures over 60°C.
- ! Follow the instructions given on the detergent packaging.

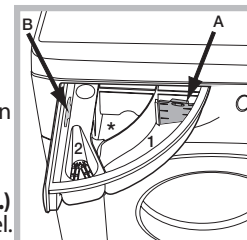

WASH CYCLES

Follow the instructions on the symbols of the garment's wash care label. The value indicated in the symbol is the maximum recommended temperature for washing the garment.



Anti-Stain

this programme is suitable to heavily-soiled garments with resistant colours. It ensures a washing class that is higher than the standard class (A class). When running the programme, do not mix garments of different colours. We recommend the use of powder detergent. Pre-treatment with special additives is recommended if there are obstinate stains.

If the drying function is selected, a drying cycle automatically activates at the end of the wash cycle that resembles open-air drying, with the added advantages of preserving garments from yellowing due to sunlight exposure and preventing loss of whiteness caused by the possible presence of dust in the air. Drying cycles can only be selected on a level basis. Dryness level "△" recommended.

Anti-Stain Quick

this programme is ideal for washing the most difficult daily stains in 1 hour. It is ideal for mixed fabrics and coloured garments, caring for your clothes as it washes.

If the drying function is selected, a drying cycle automatically activates at the end of the wash cycle that resembles open-air drying, with the added advantages of preserving garments from yellowing due to sunlight exposure and preventing loss of whiteness caused by the possible presence of dust in the air. Drying cycles can only be selected on a level basis. Dryness level "△" recommended.

Whites

for heavily soiled whites and resistant colours.

Cotton

Use this cycle to wash white clothes normally dirty. The programme is designed to maintain the brightness of white clothes over time. Use powder detergent for best results.

Eco Cotton

Suitable for washing moderately soiled cotton garments. At 40°C and 60°C it is the standard cycle for washing cotton garments, and is the most efficient in terms of combined water and electricity consumption.

Synthetics

Suitable for washing moderately soiled garments made of synthetic fibres (e.g. polyester, polyacrylic, viscose, etc.) or mixed synthetic-cotton fibres.

Anti Allergy

Suitable for removing major allergens such as pollen, mites and cat or dog hair.

Wool - Woolmark Apparel Care - Green:

the wool wash cycle of this machine has been approved by The Woolmark Company for the washing of wool garments labelled as "hand wash" provided that the products are washed according to the instructions on the garment label and those issued by the manufacturer of this washer-dryer (M1318)



Delicates

use programme to wash very delicate garments with decorative features, such as diamantes and sequins.

We recommend turning the garments inside out before washing and placing small items into the special bag for washing delicates.

When selecting an exclusively time-based drying function, a drying cycle is performed at the end of the wash cycle that is particularly delicate, thanks to light handling and appropriate temperature control of the water jet.

The recommended durations are:

1 kg of synthetic garments --> 150 min

1 kg of synthetic and cotton garments --> 180 min

1 kg of cotton garments --> 180 min

The degree of dryness depends on the load and fabric composition.

Fast Wash 30'

For washing lightly soiled garments in a short time. Not suitable for wool, silk and garments to be washed by hand.

Wash & Dry 45'

select programme for washing and drying lightly soiled garments (Cotton and Synthetics) in a short time. This cycle may be used to wash and dry a laundry load of up to 1 kg in just 45 minutes. To achieve optimum results, use liquid detergent and pre-treat cuffs, collars and stains.

Drying Cottons

To dry cotton garments.

Drying Synthetics

To dry synthetics garments.

Drying Wool

To dry wool garments.

Rinse

Designed for rinsing and spinning.

Spin + Pump out

Designed for spinning and draining the water.

INDICATOR LIGHTS

The indicator lights provide important information. This is what they can tell you:

Wash cycle phase indicator lights

Once the desired wash cycle has been selected and has begun, the indicator lights switch on one by one to indicate which phase of the cycle is currently in progress.

Wash 

Rinse 

Spin 

Drying 

End of wash cycle 

Note: as soon as a drying level or time period has been set, this indicator light illuminates to indicate that the selected wash cycle will be followed by a drying phase.

Note: during the "Drain" phase, the indicator light corresponding to the "Spin" cycle phase will illuminate.

Door locked indicator light

If this indicator light is on, the appliance door is locked to prevent it from being opened accidentally; to avoid any damage, wait for the indicator light to switch off before you open the appliance door (wait approximately 3 minutes).



! If the START/PAUSE  indicator light (orange) flashes rapidly at the same time as the function indicator light, this indicates a problem has occurred (see "Troubleshooting").

FIRST-TIME USE

Once the appliance has been installed, and before it is used for the first time, run a wash cycle with detergent and no laundry, by setting the "Auto-Clean" cycle.

DAILY USE

Prepare the laundry by following the suggestions appearing under the "TIPS AND SUGGESTIONS" section.

- Press the ON/OFF button ; all the indicator lights will turn on for a few seconds, then only the indicator lights relative to the selected programme settings will remain lit and the START/PAUSE  indicator light will flash.

- Open the door. Load the laundry while making sure not to exceed the maximum load quantity indicated in the wash cycle table.



- Pull out the detergent dispenser drawer and pour the detergent into the relevant compartments, as described in the "DETERGENT DISPENSER DRAWER" section.

- Close the door.



- Select the desired wash cycle.

- Set the washing temperature.





- Select the desired options.

- Press the START/PAUSE  button to start the wash cycle; the relative indicator light will light up steady green and the door will lock (the  indicator light will switch on).



PAUSING A CYCLE

To pause the wash cycle, press the START/PAUSE  button again; the indicator light will flash amber. To start the wash cycle from the point at which it was interrupted, press the START/PAUSE  button again.

OPENING THE DOOR, IF NECESSARY



Once a cycle starts, the  indicator light turns on to signal that the door cannot be opened. While a wash cycle is running, the door remains locked. To open the door while a cycle is under way, for example, to add or remove garments, press the START/PAUSE  button to pause the cycle; the indicator light will flash amber. If the  indicator light is not lit, the door may be opened (wait approximately 3 minutes). Press the START/PAUSE  button again to continue the cycle.

CHANGING A RUNNING WASH CYCLE

To change a wash cycle while it is in progress, pause the washer-dryer using the START/PAUSE  button (the relative indicator light will flash amber), then select the desired cycle and press the START/PAUSE  button again.

! To cancel a cycle that has already begun, press and hold the ON/OFF  button. The cycle will be stopped and the machine will switch off.

AT THE END OF THE WASH CYCLE

At the end of the wash cycle the END indicator light will switch on; when the  indicator light switches off, the door may be opened (wait approximately 3 minutes). Open the door, unload the laundry and switch off the machine. If you do not press ON/OFF  button, the washer-dryer will switch off automatically after about a half of an hour.

OPTIONS

- If the selected function is not compatible with the programmed wash cycle, the corresponding indicator light will flash and a sound alert (3 beeps); the function will not be activated.

- If a function which is incompatible with another function selected previously, only the most recent selection will remain active.

Super Wash

This option offers a high-performance wash due to the greater quantity of water used in the initial phase of the cycle, and due to the increased wash cycle duration, is particularly useful for the removal of stubborn stains.

Slow Spin

By selecting this function, reduces the spin speed.

Time Saver

If you select this option, the wash cycle duration will be reduced by up to 50%, depending on the selected cycle, thereby guaranteeing simultaneous water and energy saving. Use this cycle for lightly soiled garments.

Eco Wash

The Eco Wash option saves energy by not heating the water used to wash your laundry – an advantage both to the environment and to your energy bill. Instead, intensified wash action and water optimisation ensure great wash results in the same average time of a standard cycle. For the best washing results we recommend the usage of a liquid detergent.

By also turning the DRYING knob to the  position, a drying cycle automatically activates at the end of the wash cycle that also helps to reduce energy consumption, thanks to an optimal combination of air temperature and cycle duration.

Temperature

Turn the TEMPERATURE knob to set the wash temperature (see Table of wash cycles).

The temperature may be lowered, or even set to a cold wash (*). The washer-dryer will automatically prevent you from selecting a temperature which is higher than the maximum value set for each wash cycle.

Drying

Turn the DRYING knob to set the desired drying type.

Two options are available:

A - Based on time: from **40** to **180** minutes.

B - Based on the how damp the clothes are once they have been dried:

Iron : slightly damp clothes, easy to iron.

Hanger : dry clothes to put away.

Cupboard : very dry clothes, recommended for towelling and bathrobes.

If your laundry load to be washed and dried is much greater than the maximum stated load (see adjacent table), perform the wash cycle, and when the cycle is complete, divide the garments into groups and put some of them back in the drum. At this point, follow the instructions provided for a “Drying only” cycle. Repeat this procedure for the remainder of the load.

N.B: when the drying is complete there is a cooling period, even though the DRYING knob is in the  position.

Drying only

Turn the WASH CYCLE knob to one of the drying settings (**12-13-14**) according to the type of fabric, then select the desired drying duration using the DRYING knob.

Selecting the cotton drying cycle ( position) through the programme selector knob and pressing the “Eco” button activates an automatic drying cycle that allows for saving energy, thanks to an optimal combination of air temperature and cycle duration.

TIPS AND SUGGESTIONS

Divide the laundry according to:

Type of fabric (cotton, mixed fibres, synthetics, wool, garments to be hand-washed). Colour (separate coloured garments from whites, wash new coloured garments separately). Delicates (small garments – such as nylon stockings – and items with hooks – such as bras: insert them in a fabric bag).

Empty the pockets:

Objects such as coins or lighters can damage the washer-dryer and the drum. Check all buttons.

CARE AND MAINTENANCE

Before performing cleaning and maintenance, switch the washer-dryer off and disconnect it from the mains power. Do not use flammable liquids to clean the washer-dryer.

Cutting off the water and electricity supplies

Close the water tap after every wash. This will limit wear on the hydraulic system inside the washer-dryer and help to prevent leaks.

Unplug the washer-dryer when cleaning it and during all maintenance work.

Cleaning the washer-dryer

The outer parts and rubber components of the appliance can be cleaned using a soft cloth soaked in lukewarm soapy water. Do not use solvents or abrasives.

The washer-dryer has a “Auto-Clean” cycle for its internal parts; it must be run without any load in the drum.

To optimise this cycle, it is possible to use either detergent (10% of the quantity specified for lightly soiled garments) or special additives to clean the washer-dryer. We recommend running a cleaning cycle every 40 wash cycles.

To start the cycle press buttons “**Super Wash**” and “**Slow Spin**” simultaneously for 5 seconds.

The cycle will start automatically and will run for about 70 minutes. To stop the cycle, press the START/PAUSE  button.

Cleaning the detergent dispenser drawer

Remove the dispenser drawer by lifting and pulling it outwards. Wash it under running water; this procedure should be effected regularly.

Caring for the door and drum

Always leave the porthole door ajar in order to prevent unpleasant odours from forming.

Cleaning the pump

The washer-dryer is fitted with a self-cleaning pump that does not require any maintenance. Small items (such as coins or buttons) may sometimes fall into the protective pre-chamber situated at the base of the pump.

! Make sure that the wash cycle has ended and unplug the appliance.

To access the pre-chamber:

1. remove the covering panel on the front side of the machine by inserting a screwdriver in the centre and sides of the panel and using it as a lever;
2. loosen the drainage pump cover by turning it anti-clockwise: it is normal for some water to leak out;
3. clean the inside thoroughly;
4. screw the cover back on;
5. put the panel back in place, making sure the hooks slot in place before pushing the panel onto the appliance.

Checking the water inlet hose

Check the water inlet hose at least once a year. If it is cracked or broken, it must be replaced: during wash cycles, the high pressure of the water could suddenly split the hose open.

! Never use hoses that have already been used.

LOAD BALANCING SYSTEM

Before every spin cycle, to avoid excessive vibrations before every spin and to distribute the load in a uniform manner, the drum rotates continuously at a speed which is slightly greater than the washing rotation speed. If, after several attempts, the load is not balanced correctly, the machine spins at a reduced spin speed. If the load is excessively unbalanced, the washer-dryer performs the distribution process instead of spinning. To encourage improved load distribution and balance, we recommend small and large garments are mixed in the load.

ACCESSORIES

Contact our Technical Assistance Service to check whether the following accessories are available for this washer-dryer model.

Stacking kit

With this accessory you can secure the tumble dryer to the upper part of your washer-dryer to save space and facilitate loading and unloading of the tumble dryer.

TRANSPORT AND HANDLING

Do not lift the washer-dryer by gripping it from the upper section.





Unplug the appliance and close the water tap. Check that the door and detergent dispenser drawer are tightly closed. Detach the filling hose from the water tap then detach the drain hose. Empty all the water remaining in the hoses and secure the latter so that they do not get damaged during transport. Apply the transport bolts back on. Repeat, in reverse order, the transport bolt removal procedure described in the “Installation instructions”.

Important: Not emptying contents from pockets may cause pump or drain blockages, or may damage the machine.

Do not wash items which do not have a wash label, or wash items that are not intended as machine washable.

TROUBLESHOOTING

Your machine could occasionally fail to work. Before contacting the Technical Assistance Service, make sure that the problem cannot be easily solved using the following list.

Anomalies	Possible causes / Solution
The machine does not switch on.	The appliance is not plugged into the socket fully, or not enough to make contact. There is no power to the socket, or the fuse has blown in the mains plug.
The wash cycle does not start.	The door is not closed properly. The ON/OFF  button has not been pressed. The START/PAUSE  button has not been pressed. The water tap has not been turned on to allow water to flow into the machine. A delayed start has been set.
The machine does not fill with water or the indicator light for the first wash cycle stage flashes rapidly.	The water inlet hose is kinked. The water inlet hose is not connected to the water supply. The water pressure is too low. The water tap has not been turned on to allow water to flow into the machine. There is no water supply to the house. The inlet valve filter is blocked. The START/PAUSE  button has not been pressed.
The machine continuously fills with water and continually drains away or Water left in the drum or Stuck on wash.	The top of the drain hose is too low - It must be fitted at a height between 65 and 100 cm from the floor. The drain hose is connected incorrectly to the sink trap allowing water to run into the machine, the drain hose must be positioned higher than the bottom of the sink to prevent water flowing down the drain hose. The end of the drain hose has been pushed too far down the standpipe, the 'U' bracket should be fitted 100 mm from the end of the drain hose.
The machine does not drain or spin - (error lights flashing).	The Pump filter is blocked. The drain hose is kinked. New Installation - The blanking cap or spigot has not been removed if connected under a sink. The drain hose or sink trap is blocked.
The machine does not heat or poor wash results.	The 'Temperature' is set to "✳" position.
The programme takes too long.	Programme times will vary due to water pressure, the incoming water temperature and if the wash load goes out of balance. This will increase the programme times accordingly.
The washer-dryer vibrates a lot during the spin cycle.	The feet have not been adjusted, enabling the machine to rock. New Installation - Either the Transit Bolts including the plastic spacers, or the Polystyrene Packaging have not been removed when installing the machine. The machine is trapped between cabinets and/or walls. The load is in a slight out of balance condition and machine is spinning, but at a lower speed.
The machine is noisy.	There will always be some motor, pump and drum noise during spin.
The machine leaks from the dispenser.	The dispenser drawer is blocked with detergent and requires cleaning. The water pressure is too high and requires turning down - turn down the tap on the water supply pipe slightly and try again. The machine is tilting forwards - It must be level when in its final position.
The indicator lights on the console are flashing rapidly.	Switch off the machine and unplug it, wait for approximately 1 minute and then switch back on again. If the problem persists contact Technical Assistance Centre.
The machine smells.	The machine requires a service wash. Run a auto clean wash cycle with detergent and no laundry.
The water level is too low when the machine is washing.	The water level is correct if it can be seen at the bottom of the door.
There is too much foam.	The detergent is not suitable for machine washing (it should display the text 'for washer-dryers' or 'hand and machine wash' or the like).
General.	Your washer-dryer contains sensors that monitor progress during the wash cycle (eg: Water Levels, Temperatures, Out of Balance loads, Wash time/progress). Normally, if your machine successfully completes the cycle, there is unlikely to be anything wrong!
The washer-dryer does not dry.	The appliance is not plugged into the socket, or not enough to make contact. There has been a power failure. The appliance door is not shut properly. DRYING is in the  position.



You can download the **SAFETY AND INSTALLATION INSTRUCTIONS, OPERATING MANUAL, TECHNICAL SHEET and ENERGY DATA** by:

- Visiting the website <http://docs.hotpoint.eu>.
- Using the QR code.
- Alternatively, **contact our Technical Assistance Service** (the telephone number is indicated in the warranty booklet). When contacting the Technical Assistance Service, provide the codes shown on the adhesive label applied to the inside of the door.

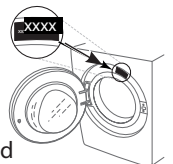

11313132