

FP401012 MUK Rev3

**morphy richards**<sup>®</sup>  
smart ideas for your home



# PREPSTAR Food Processor

 Please read and keep these instructions for future use

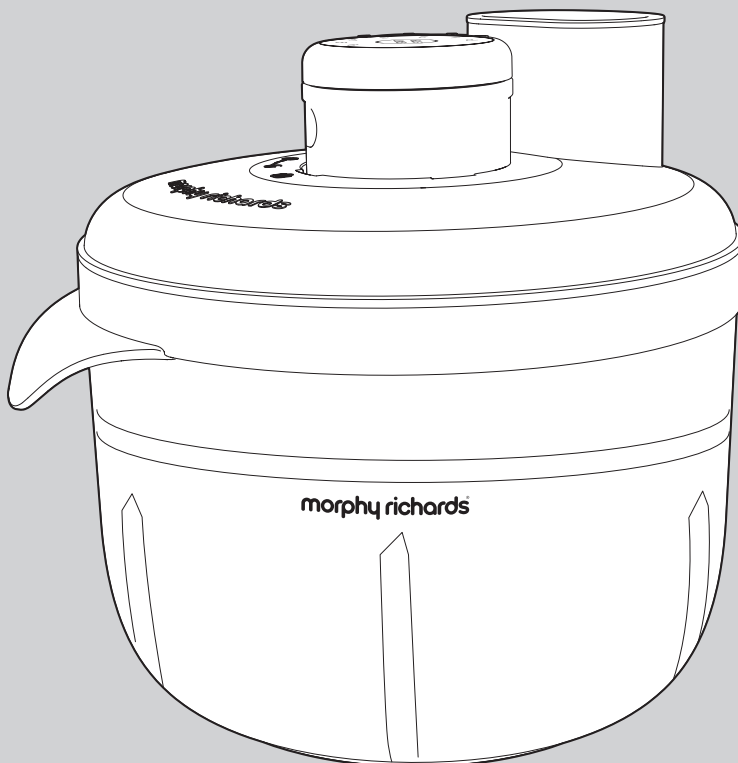

For competitions, product hints and tips  
and more join us at



[www.morphyrichards.co.uk/blog](http://www.morphyrichards.co.uk/blog)



[www.facebook.com/morphyrichardsuk](https://www.facebook.com/morphyrichardsuk)



[@loveyourmorphy](https://twitter.com/loveyourmorphy)

[www.morphyrichards.com](http://www.morphyrichards.com)

## Health And Safety

The use of any electrical appliance requires the following common sense safety rules.

**Please read these instructions carefully before using the product.**

- **WARNING: Misuse of appliance could cause personal injury.**
- Do not use continuously for longer than times stated on page 10. After using for this length of time, allow to cool for 60 minutes.
- This appliance can be used by persons with reduced physical, sensory or mental capabilities, or lack of experience and knowledge, if they have been given supervision or instruction concerning the use of the appliance in a safe way and understand the hazards involved.
- Children shall not play with the appliance.
- This appliance shall not be used by children.
- Keep appliance and cord out of the reach of children.
- Avoid touching moving parts. Keep hands, hair and clothing, and utensils away from the Prepstar attachments during operation, to prevent personal injury and/or damage to the appliance.
- Switch off the appliance and disconnect from the supply before changing accessories or approaching parts that move in use.
- If the supply cord is damaged, it must be replaced by the manufacturer, its service agent or similarly qualified persons in order to avoid a hazard.
- Unplug from the outlet when not in use, or when left unattended, and before assembling, disassembling or cleaning.
- For care and cleaning refer to page 10.

In addition, we offer the following safety advice.

### Location

- Do not use outdoors or in a bathroom.
- Always locate your appliance away from the edge of the worktop.

### Mains cable

- Do not let the mains cable hang over the edge of the worktop where a child could reach it.
- Do not let the lead run across an open space e.g. between a low socket and a table.
- Do not let the cable run across a cooker or other hot area which might damage the cable.
- The mains cable should reach from the socket to the base unit without straining the connections.
- The power cord cannot be replaced. Contact Morphy Richards for advice.

### Other safety considerations

- Do not use the appliance for anything other than its intended purpose.
- The use of attachments or tools not recommended or sold by Morphy Richards may cause fire, electric shock or injury.

### Product specific safety

- Do not operate any appliance with a damaged cord or plug or after the appliance malfunctions or has been damaged in any manner.

### Electrical requirements

Check that the voltage on the rating plate of your appliance corresponds with your house electricity supply which must be A.C. (Alternating Current).

Should the fuse in the mains plug require changing, a 3 amp BS1362 fuse must be fitted.

## Introduction

Thank you for purchasing your new Morphy Richards Prepstar Food Processor.

Prepstar will help you take care of all your daily food preparation tasks, slicing, shredding, chopping, beating, whisking and grating food in seconds, making meal preparation quick and easy.

Prepstar will not only save you time in the kitchen, but save space in your kitchen cupboards due to its space-saving design.

The unique design allows all the accessories to be stored inside the appliance for compact, easy storage.

Please read the instructions thoroughly before use.

Remember to visit [morphyrichards.co.uk](http://morphyrichards.co.uk) to register your products two-year guarantee.

## Contents

<b>Health And Safety</b> .....	<b>2</b>
<b>Introduction</b> .....	<b>3</b>
<b>Product Overview</b> .....	<b>4</b>
<b>Accessories Overview</b> .....	<b>5</b>
<b>Compact For Storage</b> .....	<b>6</b>
<b>In Use</b> .....	<b>6</b>
<b>Speed Dial Function</b> .....	<b>7</b>
<b>Pulse Function</b> .....	<b>7</b>
<b>Before First Use</b> .....	<b>8</b>
<b>Unpacking From Storage</b> .....	<b>8</b>
<b>Reassembling For Storage</b> .....	<b>8</b>
<b>Assembly For Use</b> .....	<b>9</b>
<b>Usage</b> .....	<b>10</b>
<b>Quick Cleaning</b> .....	<b>10</b>
<b>Recipes</b> .....	<b>11</b>
<b>Chopping Blade Recipes</b> .....	<b>12 - 21</b>
<b>Beater Recipes</b> .....	<b>22</b>
<b>Whisk Recipes</b> .....	<b>23</b>
<b>Grater Disc Recipes</b> .....	<b>24 - 25</b>
<b>Contact Us</b> .....	<b>25</b>
<b>Notes</b> .....	<b>26 - 27</b>
<b>Guarantee</b> .....	<b>28</b>

## Product Overview

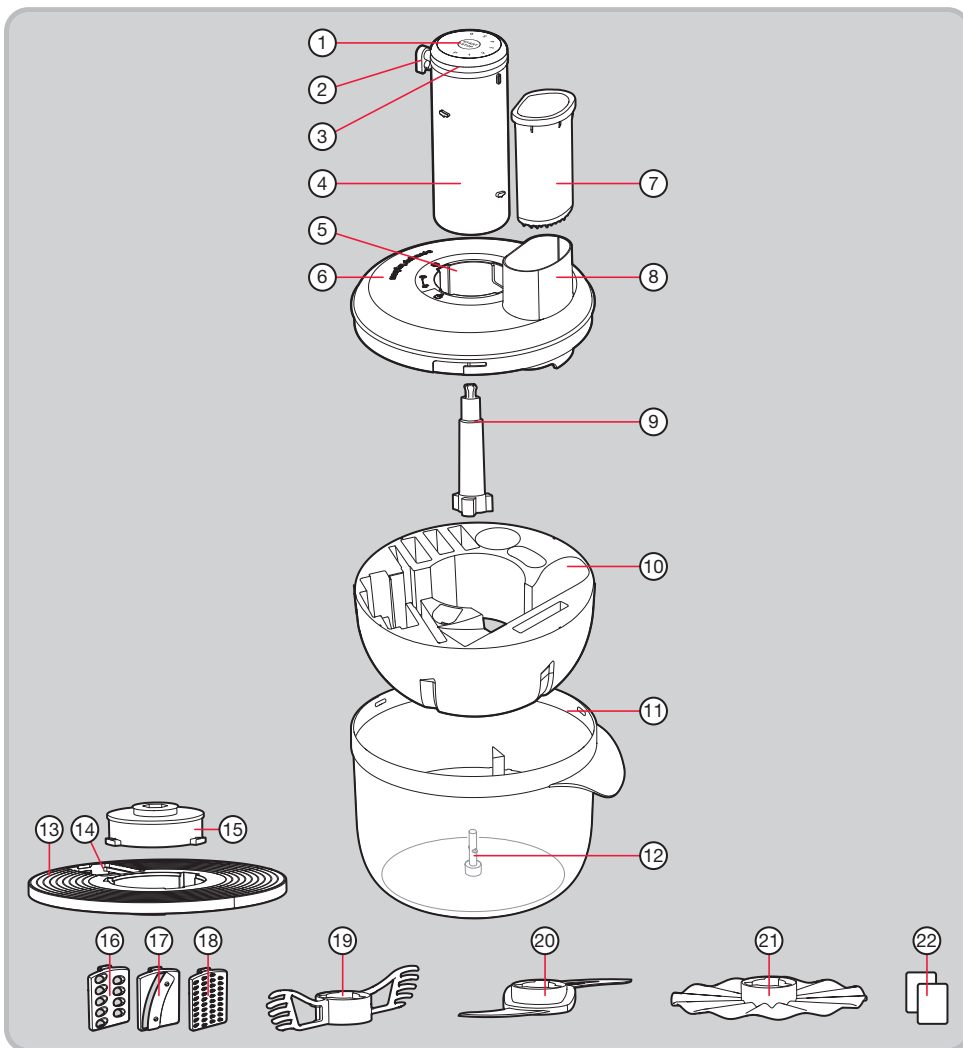

## Features

- |                        |                                    |                        |
|------------------------|------------------------------------|------------------------|
| (1) Start/Stop Button  | (9) Drive Shaft                    | (17) Slicing Blade     |
| (2) Cord Clip          | (10) Storage Bowl                  | (18) Fine Grater Blade |
| (3) Speed Dial         | (11) Mixing Bowl                   | (19) Beater            |
| (4) Motor Unit         | (12) Mixing Bowl Spindle           | (20) Chopping Blade    |
| (5) Motor Unit Locator | (13) Grater Disc                   | (21) Whisk             |
| (6) Bowl Lid           | (14) Grater / Slicing Blade Holder | (22) Instruction Cards |
| (7) Food Pusher        | (15) Grater Disc Adaptor           |                        |
| (8) Food Chute         | (16) Grater Blade                  |                        |

## Accessories Overview

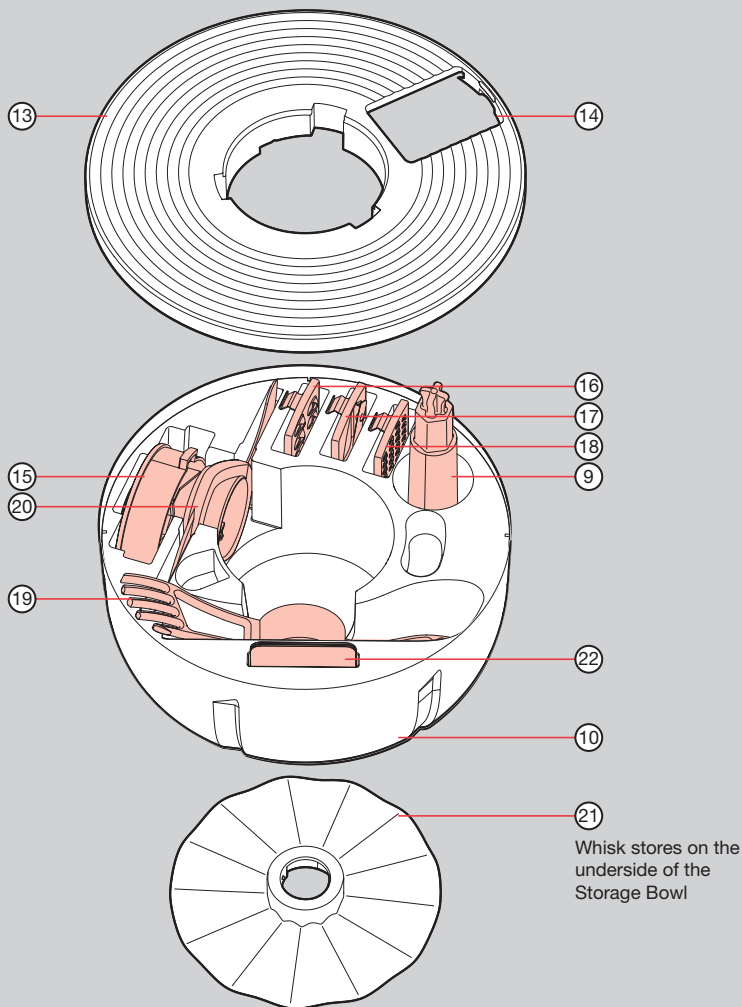

## Accessories

- |                                    |                        |
|------------------------------------|------------------------|
| (9) Drive Shaft                    | (19) Beater            |
| (10) Storage Bowl                  | (20) Chopping Blade    |
| (13) Grater Disc                   | (21) Whisk             |
| (14) Grater / Slicing Blade Holder | (22) Instruction Cards |
| (15) Grater Disc Adaptor           |                        |
| (16) Grater Blade                  |                        |
| (17) Slicing Blade                 |                        |
| (18) Fine Grater Blade             |                        |

## Compact For Storage

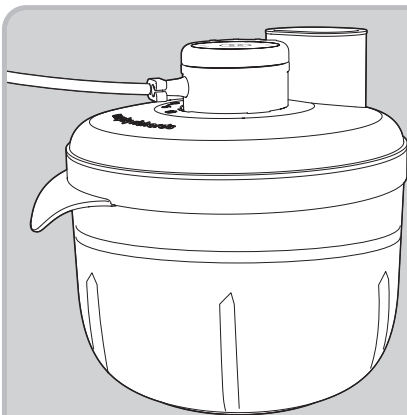

With the Power Cable facing away from the Food Chute (8), align the lower grooves on the Motor Unit (4) with the matching indents on the Motor Unit Locator (5) and gently lower into the Mixing Bowl (11). Twist clockwise once in place to lock.

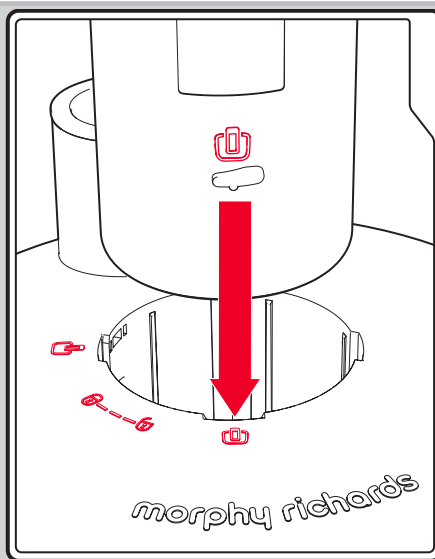

## In Use

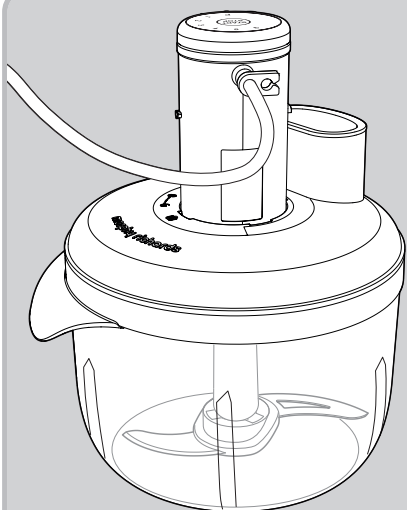

With the Power Cable facing away from the Food Chute (8) as shown above, align the lower grooves on the Motor Unit (4) with the matching indents on the Motor Unit Locator (5) and gently lower into the Mixing Bowl (11). Twist clockwise once in place to lock.

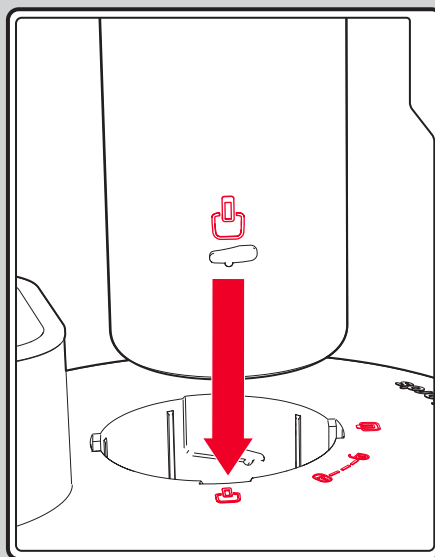

## Speed Dial Function

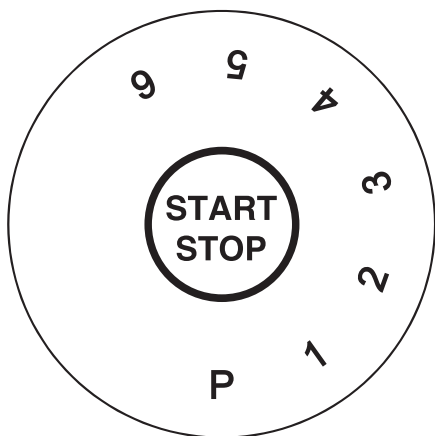

### Pulse Mode

- Set the Speed Dial **(3)** to the 'P' position, then, press and hold the Start/Stop Button **(1)**.
- The unit will pulse at the max speed setting until the Start/Stop Button **(1)** is released.
- Use the Pulse Mode when sudden bursts of speed are required.
- Good for chopping sparsely to maintain a chunky consistency, eg. for Salsas etc.
- Ideal for use with the Chopping Blade **(20)**.
- Not recommended for use with the Grater Disc **(13)**.

### Speed Settings

- Set the Speed Dial **(3)** to the desired speed setting (1-6) and press the Start/Stop Button **(1)** once to turn on.
- Once in use, you can cycle through the speed settings by turning the Speed Dial **(3)** without having to press the Start/Stop Button **(1)** again.
- To turn off the unit, press the Start/Stop Button **(1)**.

NOTE: Turning the Speed Dial **(3)** to the 'P' position whilst in use stops the unit. The Start/Stop Button **(1)** must be held down to use the Pulse Mode.

## Before First Use

Before first use, carefully unpack your Prepstar Food Processor and its attachments and remove any package material, labels or stickers.

**WARNING: Sharp blades.**

Clean all the parts except the Motor Unit (4), following the instructions on page 10.

**CAUTION: Handle the blades with extreme care as they are sharp.**

## Unpacking From Storage

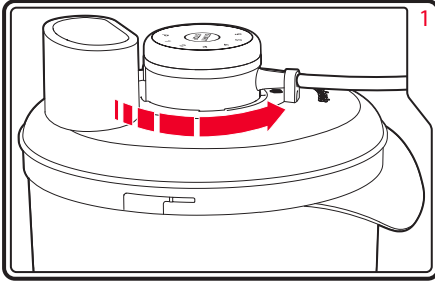

Twist the Motor Unit (4) anti-clockwise into the unlock position (Ⓣ).

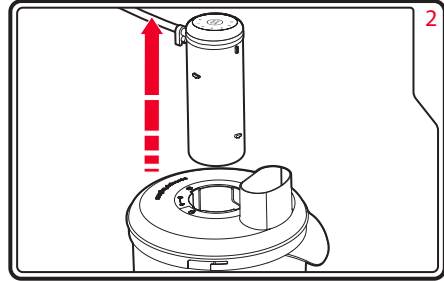

Then lift out the Motor Unit (4).

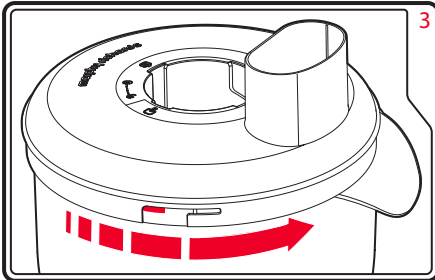

Twist the Bowl Lid (6) anti-clockwise to unlock, then lift.

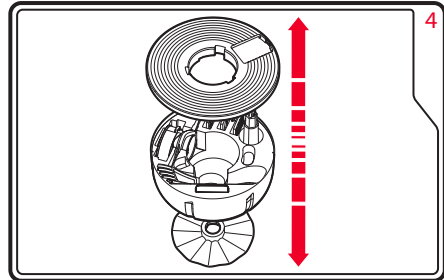

Lift off the Grater Disc (13) from the Storage Bowl (10), and pull the Storage Bowl (10) out from the Mixing Bowl (11). The Whisk (21) is located underneath the Storage Bowl (10).

## Reassembling For Storage

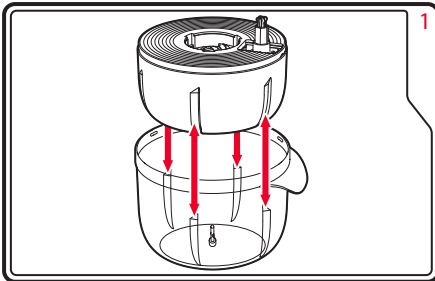

When reassembling, make sure to align the grooves of the Mixing Bowl (11) and Storage Bowl (10), then slide the Storage Bowl (10) into the Mixing Bowl (11).

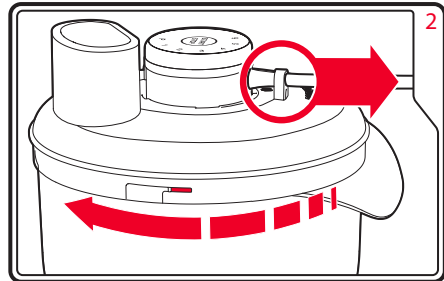

Place the Bowl Lid (6) onto the Mixing Bowl (11), aligning the grooves and twist clockwise to lock. Insert the Motor Unit (4) so that the power cable is facing away from the Food Chute (8) and twist clockwise to lock.



## Assembly For Use

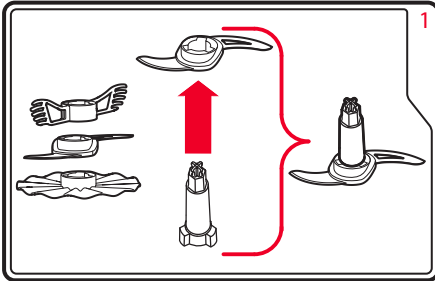

Push the Drive Shaft (9) up through the base of the relevant accessory: Beater (19); Chopping Blade (20); Whisk (21).

**WARNING: The Chopping Blade (20) is very sharp.**

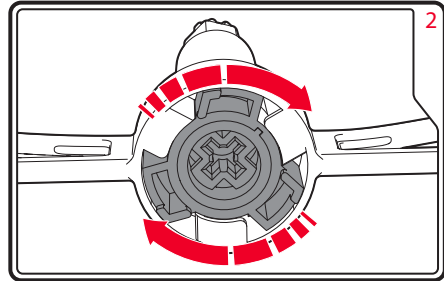

Lock the Drive Shaft (9) in place when in the accessory by twisting it clockwise to attach to the accessory.

Unlock and remove the Drive Shaft (9) by twisting it anti-clockwise and pulling it away from the base of the accessory.

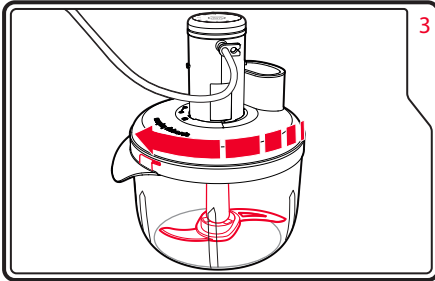

Place the Drive Shaft (9) with locked accessory onto the Mixing Bowl Spindle (12). Add the Bowl Lid (6) and Motor Unit (4) as described in the 'In Use' section on page 6.

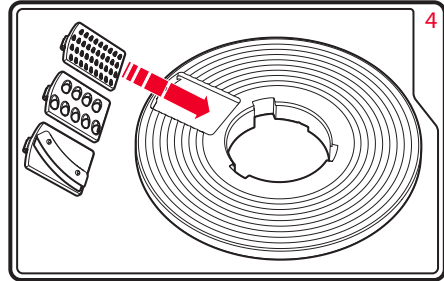

Alternatively, if using the Grater Disc (13), clip the relevant Grater Blade (16/17/18) into the Grater Disc (13). To remove, press down on the latch and push the back of the Grater Blade (16/17/18).

**WARNING: The Slicing Blade is very sharp.**

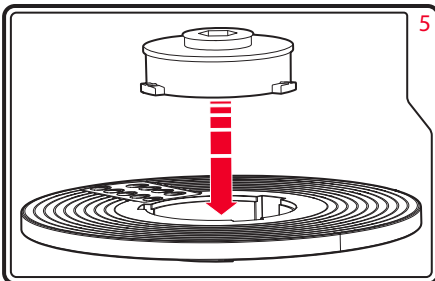

The Grater Disc Adaptor (15) locks into place with the Grater Disc (13) in the same way that the other accessories lock onto the Drive Shaft (9) in step 2. Once locked into place, place on top of the Drive Shaft (9).

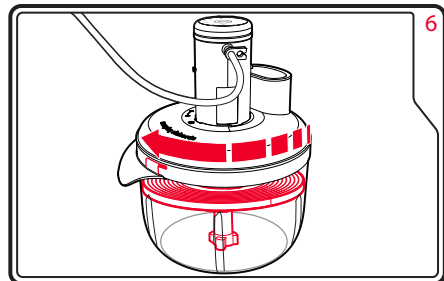

Place the Drive Shaft (9) with Grater Disc (13) onto the Mixing Bowl Spindle (12). Add the Bowl Lid (6) and Motor Unit (4) as described in the 'In Use' section on page 6.

## Usage

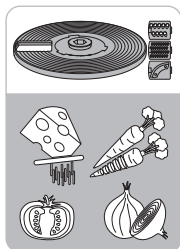

	Time	Amount	Speed
	60 secs	250g	5/6
	60 secs	250g	5/6
	60 secs	250g	5
	60 secs	250g	5

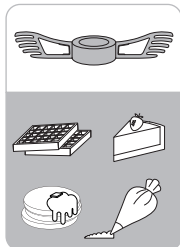

	Time	Amount	Speed
	60 secs	500ml	Pulse
	20 secs	500g	Pulse
	60 secs	500ml	Pulse
	30-40 secs	300g	Pulse



	Time	Amount	Speed
	60 secs	450g	Pulse
	-	250g	Pulse x3
	30-40 secs	200g	4/5
	-	200g	Pulse x7

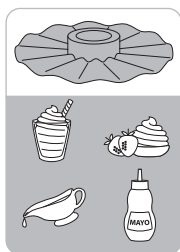

	Time	Amount	Speed
	2 mins	200ml	5
	40-70 secs	300/600g	4/5
	60 secs	400ml	5
	10-12 mins	300g	4

## Quick Cleaning

1. Pour some water (200ml) and a drop of washing up liquid into the Mixing Bowl (11), fit the Bowl Lid (6) and Motor Unit (4), select PULSE on the Speed Dial (3) for a few seconds for quick cleaning (Chopping Blade (20) to be fitted to agitate the water).
2. Unplug from the power socket.
3. Wipe the Motor Unit (4) with a damp cloth and dry thoroughly. Never immerse it in water. Ensure the interlock area is free from food.
4. Empty the Mixing Bowl (11), dismantle all detachable parts and wash with warm, soapy water and dry thoroughly.

**CAUTION: Care must be taken when handling the Chopping Blade and Grater Blades as they are very sharp.**

## Recipes

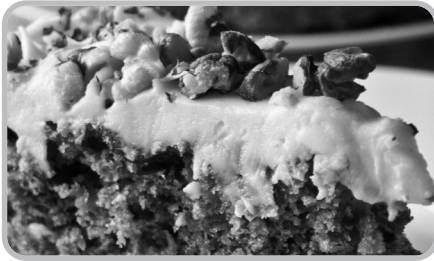

We have developed a range of delicious recipes for you to try in your new Morphy Richards Prepstar Food Processor. From dips and smoothies to cakes and creams, there is something to suit every taste.

The recipes provided give you only a few suggestions of what can be created using your Prepstar. Once you have mastered the basics you can then unlock the true versatility of the appliance.

## Chopping Blade Recipes



### Nuts

**Ingredients:**

Mixed nuts – as required, small and large quantities (max - 400g).

**Method:**

Add all ingredients.

**Speed:**

Pulse on & off until desired consistency. Maximum time 60 seconds.

---

### Seeds / dry rub

**Ingredients:**

Various seeds, coriander seed, black pepper etc – as required, small and large quantities (max - 400g).

**Method:**

Add all ingredients.

**Speed:**

Pulse on & off until desired consistency. Maximum time 60 seconds.

---

### Pesto

**Ingredients:**

50g Pine nuts  
80g Basil  
50g Parmesan  
150ml Olive oil  
2 clove garlic

**Method:**

Add all ingredients.

**Speed:**

Pulse on & off until desired consistency.

---

### Pizza Dough

**Ingredients:**

1 tbs active dry yeast  
1 tsp sugar  
0.5 cup warm water (105° to 115°F)  
1.5 cups all-purpose flour 1 tsp. salt  
1 Tbs. extra-virgin olive oil

**Method:**

- 1 Dissolve yeast & sugar in warm water for 5 minutes.
- 2 Pulse x4 - flour, salt.
- 3 Slowly add yeast mixture to the flour, allowing it to be absorbed before adding more, process until dough forms a ball (about 1 minute, then continue for 1 minute more).

**Speed:**

Pulse.

## Short Crust Pastry

### Ingredients:

125g plain flour  
Pinch of salt  
55g cubed butter (soft)  
30-45ml cold water

### Method:

- 1 Mix flour & butter until it forms a thick bread crumb consistency.
- 2 Add water and bind together, remove and shape by hand.

### Speed:

Pulse.

## Salsa

### Ingredients:

Bunch Coriander  
250g Baby Tomatoes  
1 Small onion  
½ Red Pepper  
3 Mild Chillies  
1 Lime (Juice only)

### Method:

Add all ingredients.

### Speed:

5/6.

## Mango and Avocado Salsa

### Ingredients:

100g red onions, roughly cut into 25mm dice  
½ red chilli, deseeded and halved  
10g coriander leaves  
1 ripe mango, peeled, stoned and roughly chopped  
1 ripe avocado, peeled, stoned and roughly chopped  
2 tbsp lime juice  
1 tbsp olive oil  
½ tsp salt

### Method:

- 1 Fit chopping blade and put onion, chilli and coriander in the bowl
- 2 Pulse until finely chopped. (Approx. 20 seconds). Scrape the bowl down if necessary and pulse for a few more seconds.
- 3 Add the roughly chopped mangoes, avocados, lime juice, oil and salt and pulse until of the desired consistency (10 – 15 seconds, scraping the bowl if necessary) leaving some larger chunks for texture.

### Speed:

Pulse.

## Meat Grinding

### Ingredients:

200g Pack Braising beef

### Method:

Cut into 1 / 2 inch cubes. Freeze for 15 minutes.

### Speed:

5/6.

## Coffee Beans

### Ingredients:

Whole Coffee Beans (max - 400g).

### Method:

Add whole coffee beans.

### Speed:

Pulse on & off until desired consistency. Maximum time 60 seconds.

## Falafel

### Ingredients:

2 x 400g tinned chickpeas, rinsed and drained  
 200g red onion, roughly cut into 25mm chunks  
 2 garlic cloves, halved  
 30g fresh coriander, roughly cut  
 4 tsp ground cumin  
 4 tsp ground coriander  
 4 tsp harissa paste  
 3 tbsp plain flour  
 A little salt  
 2 tbsp sunflower oil  
 For frying - 2 tbsp sunflower oil

### To serve:

Toasted Pitta, tomato salsa, green salad

### Method:

- 1 Pat the chickpeas dry with kitchen paper. Fit the blade into the bowl.
- 2 Place the chickpeas, onion, garlic, parsley, spices, flour and salt into the food processor bowl. Fit the lid.
- 3 Use speeds 4/5 as necessary until fairly smooth. Scrape the bowl sides down in between processing.
- 4 Shape into 12 patties. Place on a plate and cover with cling film in the fridge until needed.
- 5 Brush both sides of each patty with a little oil, heat a nonstick frying pan over medium heat, and add the patties then cook until browned and piping hot, turning once. (15-20 minutes).

### Speed:

4/5.

## Guacamole

### Ingredients:

150g medium size ripe tomatoes, halved  
 40g spring onions, cut in 40 mm pieces  
 ½ red chilli, deseeded and halved  
 20g fresh coriander leaves  
 Juice of 2 limes  
 2 ripe avocados, roughly chopped

### To serve:

Sunflower or pumpkin seeds.

### Method:

- 1 Fit the chopping blade in the bowl.
- 2 Add the tomatoes, spring onions, chilli and coriander and pulse for a few seconds.
- 3 Add the juice and avocados and pulse until of the desired consistency.

### Speed:

Pulse.

## Veggie Burgers

### Ingredients:

50g quinoa  
 400g tinned black beans, drained and rinsed  
 50g rolled oats  
 100g cooked beetroot, roughly chopped  
 80g red onion, roughly chopped  
 50g red pepper, roughly chopped  
 4 cloves garlic, crushed  
 1 tsp smoked paprika  
 1 tbsp maple syrup  
 1 tbsp soy sauce  
 Salt and pepper  
 For frying - 1-2 tbsp olive oil

### Method:

- 1 Rinse the quinoa with cold running water and drain. Bring 250ml water to the boil in a pan, add the quinoa and cover with a lid. Simmer for 20 minutes then drain off any remaining liquid and allow to rest for 10 minutes before forking up the grains.
- 2 Pat the beans dry with kitchen paper and set aside.
- 3 Fit the chopping blade in the bowl and add the oats. Using pulse process for 20-30 seconds or until the oats resemble flour. This may be a mixture of fine and coarser pieces.
- 4 Add the remaining ingredients and cooked quinoa to the bowl and pulse until the mixture combines without being too finely chopped or mushy, scraping the bowl down as necessary. (About 30 seconds).
- 5 Line a baking tray with non-stick baking paper. Using your hands form the mixture into 6 burgers, place on the tray and flatten slightly. Cover with tin foil and then refrigerate overnight.
- 6 When you're ready to cook the burgers, heat a little olive oil in the frying pan over a medium heat and when hot, cook until crispy and cooked through, turning as necessary.
- 7 Serve in buns or in a lettuce wrap with a choice of relishes.

### Speed:

Pulse.

## Spicy Black Bean Burgers

### Ingredients:

400g tinned black beans, drained  
 25g rolled oats  
 50g red onion, roughly chopped  
 25g red pepper, roughly chopped  
 1 garlic clove, crushed  
 10g coriander leaves  
 ½ tsp ground cumin  
 ½ tsp ground coriander  
 ½ tsp smoked paprika  
 ½ green chilli, deseeded and roughly chopped  
 1 tbsp lime juice

### Method:

- 1 Rinse the beans under cold running water and then pat them dry with kitchen paper and set aside.
- 2 Place the oats in the bowl with the chopping blade fitted and pulse for about 20 seconds until the oats resemble flour.
- 3 Add ¾ of the beans and the other ingredients to the bowl. Pulse until fairly finely chopped.
- 4 Add the remaining beans and pulse for a few seconds so that the mixture has some coarse pieces in it.
- 5 Form into 4 burgers with your hands, refrigerate for a couple of hours or overnight on non-stick baking paper, covered with cling film.
- 6 Heat a little olive oil in a frying pan and carefully transfer the burgers using a fish slice and then fry over medium heat until golden and cooked through.

### Speed:

Pulse.

## Spiced Cauliflower Couscous

### Ingredients:

450g cauliflower rice or couscous  
100g ready to eat dried apricots  
10g parsley leaves  
40g salted peanuts  
1 tbsp olive oil  
¼ tsp nutmeg  
½ tsp cinnamon  
½ tsp cumin  
½ tsp turmeric  
½ tsp smoked paprika  
salt  
black pepper  
40g currants

### To serve:

4g chopped mint.

### Method:

- 1 To make the cauliflower rice or couscous: remove the outer leaves and core from the cauliflower and discard.
- 2 Cut the cauliflower into small florets, (approx. 30mm), trim off the stalks and save for use in a stock or soup.
- 3 Fit the chopping blade and then place 400-450g florets in the bowl.
- 4 Pulse until broken down into small granules (about 20-30 seconds), give the bowl a shake or use a spatula as necessary to reposition any larger pieces.
- 5 Remove the cauliflower from the bowl and set aside.
- 6 Put the apricots, parsley and nuts in the bowl and pulse for around 10 seconds until roughly chopped. Remove and set aside.
- 7 Heat the oil in a frying pan over medium heat then add the nutmeg, cinnamon, cumin, turmeric and paprika and heat stirring for a few seconds to release the flavours.
- 8 Add the cauliflower and stir for about 1 minute to coat with the spices. Sprinkle on a little salt and pepper and then cover the pan with a lid. After cooking for one minute remove the lid and stir then replace the lid and cook for about 2 more minutes, stirring after each minute.
- 9 Add the apricots, parsley and nuts together with the currants. Heat for a minute or two, check the seasoning then serve sprinkled with a little chopped mint.

### Speed:

Pulse.



## Cauliflower Rice

### Ingredients:

1 cauliflower

### Method:

- 1 Remove the outer leaves and core and discard.
- 2 Cut the cauliflower into small florets, (approx. 30mm), trim off the stalks and save for use in a stock or soup.
- 3 Fit the chopping blade and then place 400g florets in the bowl.
- 4 Pulse in batches until broken down into small granules (about 30 seconds), give the bowl a shake or use a spatula as necessary to reposition any larger pieces.

### Uses of Cauliflower Rice:

Raw in place of grains in a salad

Added to cooked quinoa to form a more substantial meal such as kedgeree

In a side dish

Flavoured with spices and with fruit and nuts to make a pilaf

### 400g Cooked Cauliflower Rice - Method:

- 1 Place 1 tbsp olive oil into a frying pan over medium heat.
- 2 When the oil is hot, add 400g cauliflower rice, a good pinch of salt and place a lid on the pan.
- 3 Cook for about 5 minutes or until just tender, stirring halfway through cooking.
- 4 Use immediately.

### Speed:

Pulse.

## Healthy Banana and Walnut Loaf

### Ingredients:

300g bananas (peeled weight)

100g walnut halves

4 tbsp almond milk

6 tbsp olive oil

2 eggs

225g whole meal SR flour

pinch salt

¼ tsp bicarbonate of soda

½ tsp cinnamon

175g coconut sugar

### Method:

- 1 Lightly grease a 2lb loaf tin. Place a piece of non-stick baking paper lengthways into the bottom of the tin so that it is slightly longer than the tin at each end. This will make it easier to remove the cake after baking.
- 2 Preheat the oven to fan 170°C, Gas Mark 4.
- 3 Cut the bananas into roughly 40mm lengths and place in the bowl with the chopping blade fitted.
- 4 Process using pulse for 10 – 15 seconds, then add the walnuts and pulse again until chopped.
- 5 Put the milk, oil and eggs into the bowl, then add the dry ingredients.
- 6 Pulse for a few seconds then scrape the bowl sides down and pulse again until combined. Scrape the bowl again and pulse for a few more seconds. The intention is not to further chop up the nuts.
- 7 Pour the batter into the loaf tin and bake in the centre of the oven for about 1 hour or until a skewer inserted in the middle comes out clean.
- 8 Leave to cool completely in the tin and then serve with or without butter.

### Speed:

Pulse.

## Hummus

### Ingredients:

11 x 400g tinned chickpeas, drained (liquid reserved)  
 1 garlic clove, halved  
 Juice of 1.5 lemons  
 2 tbsp olive oil  
 1¼ tsp ground cumin  
 75ml tahini paste  
 Salt

### Method:

- 1 Put all in the bowl.
- 2 Pulse until smooth, then used speed 2, scraping down sides as necessary.

### Speed:

Pulse.

---

## Energy Balls

### Ingredients:

200g whole rolled oats  
 150g smooth peanut butter  
 150g clear honey  
 pinch salt  
 ½ tsp cinnamon  
 75g currants  
 35g salted peanuts  
 2 tbsp chia seeds

### Method:

- 1 Put all ingredients in the bowl with chopping blade fitted.
- 2 Pulse for about 20 seconds until a sticky dough is achieved which holds when lightly squeezed, scraping down as necessary with a spatula. Pulse another 10 seconds.
- 3 Refrigerate for 30 minutes.
- 4 Roll into walnut size balls (about 25g). Store in fridge for a week or two.

### Speed:

Pulse.

---

## Beetroot Muffins

### Ingredients:

100g dark chocolate  
 2 tbsp cocoa  
 200g plain flour (or ground almonds)  
 1½ tsp baking powder  
 3 eggs  
 150ml coconut oil, melted  
 150g clear honey  
 1 tsp vanilla extract  
 300g cooked beetroot, roughly chopped

### Method:

- 1 Melt the chocolate over a bowl of hot water.
- 2 Sieve the cocoa, flour and baking powder together into a bowl and set aside.
- 3 Put the eggs, coconut oil, honey, vanilla and beetroot and melted chocolate in the bowl, pulse for a few seconds, leaving some small pieces of beetroot, you don't want to blend it smooth.
- 4 Add the dry ingredients and pulse until just combined. Do not overbeat.
- 5 Spoon into 12 muffin cases and bake at 180°C for 25-30 minutes. Cool on a wire rack and serve.

### Speed:

Pulse.

## Clean Brownies

### Ingredients:

150g ground almonds  
 3 tbsp cocoa powder  
 2 medium eggs  
 2 tbsp coconut oil, melted  
 6 tbsp clear honey

### Method:

- 1 Lightly grease and then line the base and sides of a shallow 18cm square tin with baking paper. Preheat the oven to 180°C, Gas Mark 4.
- 2 Add the almonds and cocoa into the bowl and pulse.
- 3 Add the eggs, coconut oil and honey and mix on speed 4 until combined, scraping the bowl down with a spatula if necessary.
- 4 Pour the mixture into the tin and bake in the centre of the oven for about 20 minutes or until a skewer inserted in the middle comes out clean.

### Speed:

Pulse and 4.

---

## Avocado and Chocolate Banana Mousse

### Ingredients:

4 tbsp almond milk  
 2 large ripe avocados, peeled and roughly chopped  
 1 small banana, roughly chopped  
 2 tbsp cocoa powder  
 5 tbsp maple syrup  
 ¼ tsp vanilla extract

### To serve:

Sunflower seeds, banana slices.

### Method:

- 1 Put all ingredients in bowl with blade fitted. Use speeds 4/5 as required, scraping the bowl sides until smooth.
- 2 Spoon into individual glasses and cover with cling film. Refrigerate for 1 hour.
- 3 Decorate with sunflower seeds and thinly sliced banana.

Note: always use ripe and ready to eat avocados and banana.

### Speed:

4/5.

## Victoria Sponge

### Ingredients:

150g soft margarine  
 150g caster sugar  
 3 large eggs (weigh eggs in shells and then use same weight)  
 1½ tsp baking powder  
 150g self-raising flour

### Method:

- 1 Place the margarine, sugar, baking powder and flour in the Mixing Bowl (14) with its Chopper (20). Remove the Food Chute (17) to allow as much air into the mix as possible.
- 2 Process on speeds 5/6 until the mixture is creamed together.
- 3 Break in the eggs and process for a further 10-15 seconds.

### Speed:

5/6.

## Chocolate Chip Cookies

### Ingredients:

90g Caster Sugar  
 90g Brown sugar  
 115g butter  
 1 eggs  
 1 teaspoon vanilla  
 175g flour  
 1 teaspoon baking soda  
 Chocolate Chips

### Method:

Add granulated sugar, brown sugar, butter, eggs, and vanilla to the Mixing Bowl (14). Process on speed 5 until creamy. Add flour and baking soda; process just until mixed in. Stir in nuts and chocolate pieces.

### Speed:

5.

## Scones

### Ingredients:

225g/8oz self-raising flour  
 Pinch of salt  
 55g/2oz butter  
 25g/1oz caster sugar  
 150ml/5fl oz milk  
 1 free-range egg, beaten, to glaze (alternatively use a little milk)

### Method:

- 1 Heat the oven to 220C/425F/Gas 7. Lightly grease a baking sheet.
- 2 Mix together the flour and salt and rub in the butter, by hand.
- 3 Stir in the sugar and then the milk to get a soft dough.

### Speed:

5/6.

## Fudge Brownies

### Ingredients:

#### Group 1:

80g cocoa powder  
 ½ tsp bicarbonate of soda  
 80ml vegetable oil  
 120ml boiling water

#### Group 2:

440g caster sugar  
 2 eggs  
 80ml vegetable oil  
 190g plain flour  
 1 tsp vanilla essence  
 ¼ tsp salt

### Method:

- 1 Pre heat the oven to 175°C / Gas Mark 3-4.
- 2 Attach the Beater (9) to the Mixer. Grease and flour a 9x13 inch tin.
- 3 Mix the group 1 ingredients: Mix the cocoa with the bicarbonate of soda and add to the Mixing Bowl (14) along with the oil and water.
- 4 Mix on speed 4 until well blended and thickened, turning the Mixing Bowl as necessary.
- 5 Mix in the sugar, eggs and oil from the group 2 ingredients until thoroughly mixed.
- 6 During mixing, hold the Mixing Bowl steady and turn clockwise and anti-clockwise to allow the ingredients to mix thoroughly. It may be necessary to stop the Mixer and scrape the sides of the bowl a few times to make sure all the ingredients are incorporated.
- 7 Add the flour, vanilla and salt and mix until just incorporated using pulse, do not over mix.
- 8 Spread evenly into the prepared tin and bake for 35-40 minutes or until a skewer comes out clean.
- 9 Allow to cool before cutting into squares.

### Speed:

4 and Pulse.

## Cheesecake

### Ingredients:

200g ginger nut biscuits, halved  
 50g unsalted butter, melted  
 2 x 250g mascarpone cheese  
 40g icing sugar, sifted  
 Finely grated zest and juice of 1 orange  
 25g dark chocolate

### Method:

- 1 Fit the chopping blade and crush the biscuits in the bowl (pulse for approx 20 seconds).
- 2 Stir the biscuits into the melted butter and press evenly into the base of an 8" (20cm) loose bottom cake tin. Chill in the fridge for 45 minutes to 1 hour.
- 3 Rinse and dry the bowl and fit the cake beater. Place the mascarpone, sugar, zest and 50ml orange juice into it and pulse, scraping the bowl down as necessary. Total processing time for this stage was 20 seconds.
- 4 Spread the topping over the biscuit base and chill for a further 30 minutes.
- 5 To decorate, either grate a little of the dark chocolate over the surface or place the chocolate in a heatproof bowl over barely simmering water and melt. Drizzle over the surface of the cheesecake.

### Alternatives:

#### Lemon Cheesecake

Same recipe as above except used zest of 2 lemons, 60ml lemon juice in place of the orange zest and juice.

#### Blueberry Cheesecake

Same recipe as above except used zest of 2 lemons, 60ml lemon juice in place of the orange zest and juice.

After chilling the filling, prepare the fruit topping as follows: Place in a pan, 250g fresh blueberries, 50g caster sugar, juice of half lemon, 2 level tsp corn flour, Stir over medium heat for about 10 mins until beginning to thicken. Cool completely, then refrigerate for 30 minutes. Spoon evenly on top of the chilled cheesecake and refrigerate for a further 30 minutes or until required.

### Speed:

Pulse.

## Beater Recipes

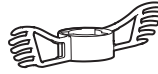

### French Dressing

#### Ingredients:

8 tbsp olive oil  
2 tbsp vinegar  
½ level tsp sugar  
½ level tsp Dijon mustard  
Salt and pepper

#### Method:

- 1 Place all ingredients in the Mixing Bowl (14).
- 2 Process until all ingredients are mixed together.

#### Speed:

Pulse.

### Mint Raita

#### Ingredients:

8 tbsp natural yogurt  
2 tsp lemon juice  
16 mint leaves, chopped  
Pinch of salt

#### Method:

- 1 Place all ingredients in the Mixing Bowl (14).
- 2 Process until all ingredients are mixed together to your desired consistency.

#### Speed:

Pulse.

### Cream Cheese and Chive Dip (150ml)

#### Ingredients:

140g medium fat cream cheese  
½ small clove garlic, crushed  
4g chives, roughly snipped  
1 tbsp soured cream  
Pinch of salt  
Freshly ground black pepper to taste  
Finely snipped chives (to garnish)

#### To serve:

Breadsticks or plain tortilla chips.

#### Method:

- 1 Place all ingredients, except the garnish, in the Mixing Bowl (14).
- 2 Process until all ingredients are mixed together, scraping the side of the Mixing Bowl part way through with a spatula if necessary.
- 3 When ready, check the seasoning.
- 4 Place the dip into a ramekin and garnish with a few snipped chives.

#### Speed:

Pulse.

## Whisk Recipes



For thicker mixes, we recommend using the chopping blade attachment instead of the whisk.

### Cream

**Ingredients:**

300ml / 600ml Whipping cream.

**Method:**

Add all cream, and process.

**Speed:**

4/5.

---

### Egg Whites

**Ingredients:**

6 Egg whites.

**Method:**

Add all egg whites, and process.

**Speed:**

5.

---

### Pancake Mixture

**Ingredients:**

115g plain flour

1 egg

280ml milk

**Method:**

Place the flour and salt in the bowl. Add the egg and a quarter of the milk. Using the whisk at speeds 5/6, mix until smooth. Gradually whisk in the remaining milk to make a smooth batter.

**Speed:**

5/6.

## Grater Disc Recipes



### French Onion Soup

#### Ingredients:

75g butter  
300g onions, peeled  
3 tbsp flour  
1.6L beef stock  
2 Bay leaves

#### To serve:

4 slices French bread, cheddar cheese.

#### Method:

- 1 Cut the onions into halves or so that it will fit down the feed tube and fit the slicing disc. Slice the onion using speed 5.
- 2 Melt the butter in a pan, add the onions and fry for 10 minutes or until browned.
- 3 Add the flour, stir gently for 1 minute, and then remove from the heat.
- 4 Gradually, stirring all the time add the stock. Then add the salt and pepper and bay leaves.
- 5 Bring to the boil, stirring all the time and then put a lid on the pan and reduce the heat to a simmer for about 30 minutes.
- 6 Before serving, adjust the seasoning if required then put a slice of bread in each soup bowl, ladle over the soup and then sprinkle with grated cheese.

#### Speed:

5.

### Asian-Style Slaw

#### Ingredients:

120g Savoy cabbage, washed, core removed  
100g carrot, washed  
50g red onion, peeled  
½ small red chilli, deseeded and thinly sliced into rings  
10g coriander leaves  
60g cashew nuts  
1 tsp fresh ginger  
1½ tsp light soy sauce  
1 tbsp sesame oil  
2 tbsp lime juice

#### Method:

- 1 Fit the slicing disc, cut the cabbage to size so it will fit down the feed tube and then process on speed 5.
- 2 Fit the coarse grating disc and process the carrot and onion on speed 5.
- 3 Remove the attachments and then add all the other ingredients into the bowl and mix well with a spatula.
- 4 Turn into a bowl and serve immediately.

#### Speed:

5.



## Buddha Bowls

### Ingredients:

This recipe is a combination of a variety of nourishing protein, rainbow coloured vegetables, textures and rice and grains. Pickles can be included. It can be dressed or left without.

### Method:

Include any of the following to make a colourful bowl of goodness:

Sliced: Avocado;  
Cucumber;  
Red Pepper;  
Radish

Grated: Carrots;  
Beetroot

Olives  
Chickpeas  
Edamame beans  
Black, kidney or borlotti beans  
Cherry tomatoes  
Quinoa  
Couscous  
Jasmine rice flavoured with coconut  
Pickled cabbage  
Seeds, e.g. chia, sunflower, linseed  
Hummus, tahini, salsa, or guacamole  
Chopped herbs

### Speed:

5.

## Contact Us

### Helpline

If you are having a problem with your Prepstar Food Processor, please call our Helpline, as we are more likely to be able to help than the store you purchased the item from.

Please have the product name, model number and serial number to hand when you call to help us deal with your enquiry quicker.

UK Helpline: **0344 871 0944**

IRE Helpline: **1800 409 119**

Spares: **0344 873 0710**

### Talk To Us

If you have any questions or comments, or want some great tips or recipe ideas to help you get the most out of your products, join us online:

Blog: **[www.morphyrichards.co.uk/blog](http://www.morphyrichards.co.uk/blog)**

Facebook: **[www.facebook.com/morphyrichardsuk](https://www.facebook.com/morphyrichardsuk)**

Twitter: **[@loveyourmorphy](https://twitter.com/loveyourmorphy)**

Website: **[www.morphyrichards.com](http://www.morphyrichards.com)**





FP401012 MUK Rev3 08/18

## Registering your 2 year guarantee

Your standard 1 year guarantee is extended for an additional 12 months when you register the product within 28 days of purchase with Morphy Richards. If you do not register the product with Morphy Richards within 28 days, your product is guaranteed for 1 year. To validate your 2 year guarantee register with us online at [www.morphyrichards.co.uk/support](http://www.morphyrichards.co.uk/support)

Or call our customer registration line, quoting model and serial number, these numbers can be found on the base of the product.

UK 0344 871 0242

IRE 1800 409 119

N.B. Each qualifying product needs to be registered with Morphy Richards individually.

Please note that the 2 year guarantee is only available in the UK and Ireland. Please refer to the 1 year guarantee for more information.

## Your 1 year guarantee

It is important to retain the retailer's receipt as proof of purchase. Staple your receipt to this back cover for future reference.

Please quote the following information if the product develops a fault. These numbers can be found on the base of the product.

Model no.

Serial no.

All Morphy Richards products are individually tested before leaving the factory. In the unlikely event of any appliance proving to be faulty within 28 days of purchase, it should be returned to the place of purchase for it to be replaced.

If the fault develops after 28 days and within 12 months of original purchase, you should contact the Helpline number quoting Model number and Serial number on the product, or write to Morphy Richards at the address shown.

You may be asked to return a copy of proof of purchase.

Subject to the exclusions, the faulty appliance will then be repaired or replaced as appropriate and dispatched usually within 7 working days of receipt.

If, for any reason, this item is replaced or repaired during the 1 year guarantee period, the guarantee on the new item will be calculated from original purchase date. Therefore it is vital to retain your original till receipt or invoice to indicate the date of initial purchase.

To qualify for the 1 year guarantee, the appliance must have been used according to the instructions supplied.

## Exclusions

Morphy Richards shall not be liable to replace or repair the goods under the terms of the guarantee where:

- 1 The fault has been caused or is attributable to accidental use, misuse, negligent use or used contrary to the manufacturer's recommendations or where the fault has been caused by power surges or damage caused in transit.
  - 2 The appliance has been used on a voltage supply other than that stamped on the products.
  - 3 Repairs have been attempted by persons other than our service staff (or authorised dealer).
  - 4 The appliance has been used for hire purposes or non domestic use.
  - 5 The appliance is second hand.
  - 6 Morphy Richards reserves the right not to carry out any type of servicing under the guarantee at its discretion.
  - 7 Batteries and damage from leakage are not covered by the guarantee.
- This guarantee does not confer any rights other than those expressly set out above and does not cover any claims for consequential loss or damage. This guarantee is offered as an additional benefit and does not affect your statutory rights as a consumer. Morphy Richards products are intended for household use only. See usage limitation.

## Disclaimer

Morphy Richards has a policy of continuous improvement in product quality and design. The company, therefore reserves the right to change the specification of its models at any time.



For electrical products sold within the European Community. At the end of the electrical products useful life, it should not be disposed of with household waste.

Please recycle where facilities exist. Check with your Local Authority or retailer for recycling advice in your country.

**IF YOU ARE HAVING A PROBLEM  
WITH ONE OF OUR PRODUCTS,  
CALL OUR HELPLINE:**

**UK: 0344 871 0944  
EIRE: 1800 409 119  
SPARES: 0344 873 0710**

**morphyrichards**

The After Sales Division  
Morphy Richards Ltd  
Mexborough, South Yorkshire,  
England, S64 8AJ

Helplines (office hours)  
UK 0344 871 0944  
Spare Parts 0344 873 0710  
Republic of Ireland 1800 409 119  
[www.morphyrichards.com](http://www.morphyrichards.com)

