

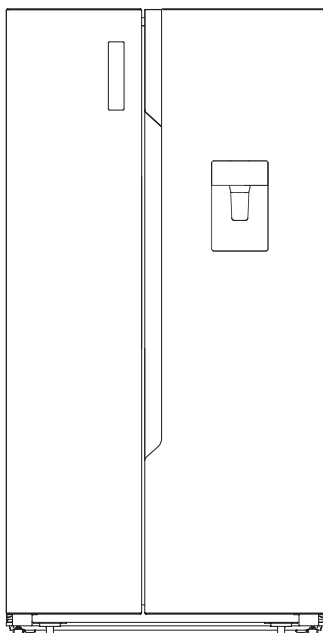

# How to use your new Fridge Freezer

Model MS91515DFF  
MS91515BFF



## Contents

Safety and warning information.....	2	Using your appliance.....	12
Installing your new appliance.....	7	Helpful hints and tips.....	16
Description of the appliance.....	9	Cleaning and care.....	17
Display controls.....	10	Troubleshooting.....	18
		Disposal of the appliance.....	19

**CE** This appliance is in accordance with the following EU guidelines: **2014/35/EU** and **2014/30/EU** and 2009/125/EC and EC.643/2009 and 2002/96/EC



## Safety and warning information

For your safety and correct usage, before installing and first using the appliance, read this user manual carefully, including its hints and warnings. To avoid unnecessary mistakes and accidents, it is important to make sure that all people using the appliance are thoroughly familiar with its operation and safety features. Save these instructions and be sure that they remain with the appliance if it is moved or sold, so that anyone using it, throughout its life, will be properly informed on its usage and safety notices. For the safety of life and property, keep the precautions of these user's

instructions as the manufacturer is not responsible for damages caused by omission.

### **Safety for children and others who are vulnerable people**

- This appliance can be used by children aged from 8 years and above and persons with reduced physical, sensory or mental capabilities or lack of experience and knowledge if they have been given supervision or instruction concerning use of the appliance in a safe way and understand the hazards involved. Children shall not play with the appliance. Cleaning and user maintenance shall not be made by children without supervision.
- Keep all packaging away

from children as there is risk of suffocation.

- If you are discarding the appliance, pull the plug out of the socket, cut the connection cable (as close to the appliance as you can) and remove the door to prevent children playing from suffering an electric shock or from closing themselves inside it.
- If this appliance, featuring a magnetic door seals, is to replace an older appliance having a spring lock (latch) on the door or lid, be sure to make the spring lock unusable before you discard the old appliance. This will prevent it from becoming a death trap for a child

### General safety



• **WARNING** — This appliance is intended to be used in household and similar applications such as

- staff kitchen areas in shops, offices and other working environments;
- farm houses and by clients in hotels, motels and other residential type environments;
- bed and breakfast type

environments;  
-catering and similar non-retail applications

- **WARNING** — Do not store explosive substances such as aerosol cans with a flammable propellant in this appliance.
- **WARNING** — If the supply cord is damaged, it must be replaced by the manufacturer, its service agent or similarly qualified persons in order to avoid a hazard.
- **WARNING** — Keep ventilation openings, in the appliance enclosure or in the built-in structure, clear of obstruction.
- **WARNING** — Do not use mechanical devices or other means to accelerate the defrosting process, other than those recommended by the manufacturer.
- **WARNING** — Do not damage the refrigerant circuit.
- **WARNING** — Do not use electrical appliances inside the food storage compartments of the appliance, unless they are of the type recommended by the manufacturer.
- **WARNING** — The refrigerant and insulation

blowing gas are flammable. When disposing of the appliance, do so only at an authorized waste disposal centre. Do not expose to flame.

## Refrigerant

The refrigerant isobutene (R600a) is contained within the refrigerant circuit of the appliance, a natural gas with a high level of environmental compatibility, which is nevertheless flammable. During transportation and installation of the appliance, ensure that none of the components of the refrigerant circuit becomes damaged. The refrigerant (R600a) is flammable.



### **Warning: Risk of fire/ flammable materials**

If the refrigerant circuit should be damaged:

- Avoid opening flames and sources of ignition.
- Thoroughly ventilate the room in which the appliance is situated.

It is dangerous to alter the specifications or modify this product in any way. Any damage to the cord may cause a shortcircuit, fire, and/or electric shock.



### **Electrical safety**

1. The power cord must not be lengthened.
2. Make sure that the power plug is not crushed or damaged. A crushed or damaged power plug may overheat and cause a fire.
3. Make sure that you can access the main plug of the appliance.
4. Do not pull the main cable.
5. If the power plug socket is loose, do not insert the power plug. There is a risk of electric shock or fire.
6. You must not operate the

appliance without the interior lighting lamp cover.

7. The fridge is only applied with power supply of single phase alternating current of 220~240V/50Hz. If fluctuation of voltage in the district of user is so large that the voltage exceeds the above scope, for safety sake, be sure to apply A.C. Automatic voltage regulator of more than 350W to the fridge. The fridge must employ a special power socket instead of common one with other electric appliances. Its plug must match the socket with ground wire.

### Daily use

- Do not store flammable gass or liquids in the appliance, There is a risk of an explosion.
- Do not operate any electrical appliances in the appliance (e.g. electric ice cream makers, mixers etc.).
- When unplugging always pull the plug from the mains socket, do not pull on the cable.
- Do not place hot items near the plastic

components of this appliance.

- **Do not place food products directly against the air outlet on the rear wall.**
- Store pre-packed frozen food in accordance with the frozen food manufacture's instructions.
- The appliances manufactures storage recommendations should be strictly adhered to. Refer to rellevant instructions for storage.
- Do not place carbonated or fizzy drinks in the freeze compartment as it creates pressure on the container, which may cause it to explode, resulting in damage to the appliance.
- Frozen food can cause frost burns if consumed straight from the freezer compartment.
- Do not place the appliance in direct sunlight.
- Keep burning candles, lamps and other items with naked flames away from the appliance so that do not set the appliance on fire.
- The appliance is intended for keeping food stuff and/or beverages in normal household as explained in this instruction booklet.

- The appliance is heavy. Care should be taken when moving it.
- Do not remove nor touch items from the freezer compartment if your hands are damp/wet, as this could cause skin abrasions or frost/freezer burns.
- Never use the base, drawers, doors etc. to stand on or as supports.
- Frozen food must not be refrozen once it has been thawed out.
- Do not consume ice popsicles or ice cubes straight from the freezer as this can cause freezer burn to the mouth and lips.
- To avoid items falling and causing injury or damage to the appliance, do not overload the door racks or put too much food in the crisper drawers.

## **caution!**

### **Care and cleaning**

- Before maintenance, switch off the appliance and disconnect the mains plug from the mains socket.
- Do not clean the appliance with metal objects, steam cleaner, ethereal oils, organic solvents or abrasive cleansers.
- Do not use sharp objects to remove frost from the appliance. Use a plastic scraper.

### **Installation Important!**

- For electrical connection carefully, follow the instructions given in this manual.
- Unpack the appliance and check if there are damages on it. Do not connect the appliance if it is damaged. Report possible damages immediately to the place you bought it. In this case retain packing.
- It is advisable to wait at least four hours before connecting the appliance to allow the oil to flow back in the

compressor.

- Adequate air circulation should be around the appliance, lacking this leads to overheating. To achieve sufficient ventilation, follow the instructions relevant to installation.
- Wherever possible the back of the product should not be too close to a wall to avoid touching or catching warm parts (compressor, condenser) to prevent the risk of a fire, follow the instructions relevant to installation.
- The appliance must not be locate close to radiators or cookers.

- Make sure that the mains plug is accessible after the installation of the appliance.

### Service

- Any electrical work required to do the servicing of the appliance should be carried out by qualified electrician or competent person.
- This product must be serviced by an authorized Service Center, and only genuine spare parts must be used.
  - 1)If the appliance is Frost Free.
  - 2)If the appliance contains freezer compartment.

## Installing your new appliance

Before using the appliance for the first time, you should **review** the following tips.

### Ventilation of appliance

 In order to improve efficiency of the cooling system and save energy, it is necessary to maintain good ventilation around the appliance for the dissipation of heat. For this reason, sufficient clear space should be available around the refrigerator. Suggest :It is advisable for there to be 75mm of space from the back to the

wall, at least 100mm from its top, at least 100mm from its side to the wall and a clear space upfront to allow the doors to open 150° .**Please see the following diagrams.**

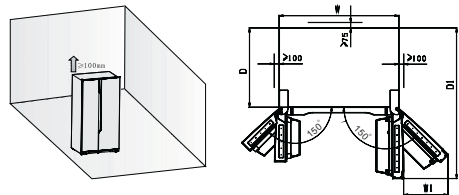

## Space required ( mm)

W	W1	D	D1
908	411.5	550	1096.5

### Note:

- This appliance performs well in the climate class from SN to ST. It may not work properly if being left at a temperature above or below the indicated range for a long period.

Climate class	Ambient temperature
SN	+10°C to +32°C
N	+16°C to +32°C
ST	+16°C to +38°C
T	+16°C to +43°C

- Stand your appliance in a dry place to avoid damage moisture .
- Keep the appliance out of direct sunlight, rain or frost. Stand the appliance away from heat sources such as stoves, fires or heaters.

### Leveling of appliance

- For sufficient leveling and air circulating in the lower rear section of the appliance, the bottom feet may need to be adjusted. You can adjust them by your fingers or a suitable spanner.
- To allow the doors to self-close, tilt back the top backwards for about 10mm or 0.5° by turning the adjustable feet.
- Whenever you want to move the appliance, remember to turn the feet back up so that the appliance can roll freely. Reinstall the appliance when relocating.

**Caution!** The rollers which are not casters, should be only used for forward or backward movement. Moving the refrigerator sideways may damage your floor and the rollers.

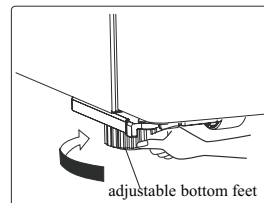
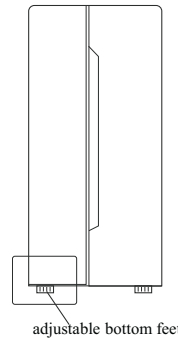
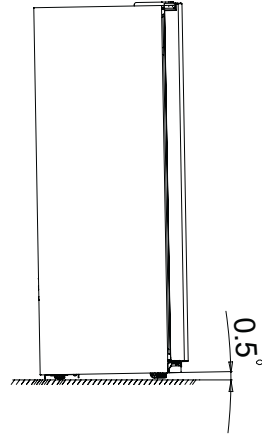



## Description of the appliance

View of the appliance



- |                                  |                                  |
|----------------------------------|----------------------------------|
| 1. Freezer zone LED light        | 11. Fresh door Rack              |
| 2. Freezer door Rack             | 12. Water tank                   |
| 3. Freezer door seal             | 13. Wind channel cover in fresh  |
| 4. Wind channel cover in freezer | 14. Egg tray (inside)            |
| 5. Freezer shelf                 | 15. Fresh shelf                  |
| 6. Ice box part                  | 16. Fresh door seal              |
| 7. Freezer upper drawer          | 17. Fresh upper drawer           |
| 8. Freezer lower drawer          | 18. Fresh lower drawer           |
| 9. Left adjustable bottom feet   | 19. Right adjustable bottom feet |
| 10. Fresh zone LED light         |                                  |

**Note:** Due to unceasing modification of our products, your refrigerator may be slightly different from this Instruction Manual, but its functions and using methods remain the same.

## Display controls

Use your appliance according to the following guidelines, your appliance has the corresponding functions and modes as the control panels showed in the pictures below.



When the appliance is powered on for the first time, the backlighting of the icons on display panel starts working. If no buttons have been pressed and the doors are closed, the backlighting will turn off after 60 seconds.

The control panel consists of two areas about temperature, one area about different modes.

### Controlling the temperature

We recommend that when you start your refrigerator for the first time, the temperature for the refrigerator is set to 4°C and the freezer to -18°C. If you want to change the temperature, follow the instructions below.

**Caution!** When you set a temperature, you set an average temperature for the whole refrigerator cabinet.

Temperatures inside each compartment may vary from the temperatures displayed on the panel, depending on how much food you store and where you place it. High or low room temperature may also affect the actual temperature inside the appliance.

### Unlock

All the buttons are locked if the icon "🔒" is illuminated, press the "🔒" "🔒" button for 3 seconds to unlock them. The fridge will lock itself if **no buttons are pressed within 20 seconds**.

### Mode

You can select "AI" by pressing the "AI/🔒" button when "🔒".

When "AI" is selected, wait for the corresponding icon flash for 10 seconds.

### Super Cool

Super Cool can refrigerate your food much faster, keeping food fresh for a longer period .

- Press "  " button to select the Super Cool function. The light will be illuminated.
- For the maximum amount of food to be Cooled , please wait about 6 h.
- Super cool automatically switches off after 6 hours and the fridge temperature setted to 2°C.

### Super Freeze

Super Freeze will quickly lower the temperature within the freezer so food will freeze faster. This can lock in the vitamins and nutrients of fresh food and keep food fresh longer.

- Press "  " button to select the Super Freeze function. The light will be illuminated.
- For the maximum amount of food to be frozen, please wait about 24 h.
- Super freeze automatically switches off after 26 hours and the freezer temperature setted to -24°C.

## Display controls

### Artificial Intelligence

- When the function is selected, the temperature of the appliance is automatically adjusted.
- When the **Artificial** Intelligence function is activated, the temperature of the fridge is automatically switched to 4°C and the freezer to -18°C.

### Fridge

- You can press the "  " button to activate the mode to control the fridge temperature. When you press the button continuously, the temperature will be set as the following sequence.

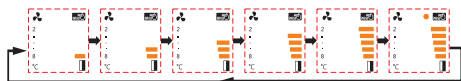

### Freezer

- You can press the "  " button to activate the mode to control the freezer temperature. When you press the button continuously, the temperature will be set as the following sequence.

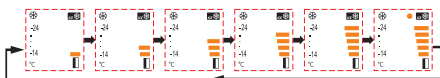

### Door Alarm

- If the door of fridge or freezer is open for over 2 minutes, the door alarm will sound. The buzzer will automatically stop alarming 10 minutes later.
- To save energy, please avoid keeping the door open for a long time when using the appliance. The door alarm can be cleared by closing the door.

## Using your appliance

This section tells you how to use most of the useful features. We recommend that you read through them carefully before using the appliance.

### 1. Adjust the door

When you find the doors are not at the same level, you can use the screwdriver to adjust the door.

When the freezer door is upper than the refrigerator door. First, you can use the screwdriver to turn the bolt anticlockwise on the lower hinge that can make the door go up. Then use the screwdriver to lock the nut in place.

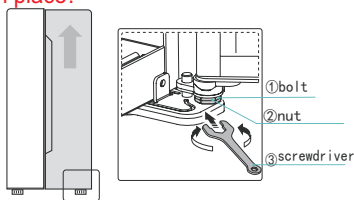

### 2. Using your refrigerator compartment

The refrigerator compartment is suitable for storage of vegetables and fruit. Food inside shall be packed to store in order to avoid losing moisture or flavor permeating into other foods.

Caution! Never close the refrigerator door while the shelves, crisper and/or telescopic slides are extended. It may damage both them and the refrigerator.

#### Glass shelves and Door racks

The refrigerator compartment is provided with 4 glass shelves and several different door racks, which are suitable for the storage of eggs, canned liquid, bottled drinks and packed food.. They can be placed at different heights according to your need. Before you lift up the door shelf vertically, please take the food out.

- When you remove the shelves, gently pull them forward until the shelf comes

clear of the shelf guides.

- When you return the shelves, make sure there is no obstacle behind and gently push the shelf back into the position.

**Note:** All the door racks are completely removable for cleaning.

### 3. Using your freezer compartment

The freezer compartment is suitable for storage of foods required to be frozen, such as meat, ice cream and others item. **Caution!** Ensure that bottles are not left in the freezer for longer than needed as freezing may cause the bottles to break.

#### Drawers

The drawers, mounted on telescopic extension slides, can be used to store large volume of food .

- The method for removing the drawers is the same as the crisper in the refrigerator chamber.

### 4. Using your ice box

- It is used for making ice and storing ice cubes.

- It is a removable accessory which can be taken out to save space. There is an ice maker cover to keep the ice maker clean.

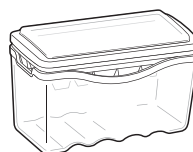

Note: If the ice maker is used for the first time or has not been used for a long time, please clean it before using.

● Ice-making process.

1. Place the integrative ice maker on level and take down the cover.

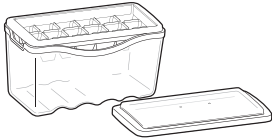

2. Pour water into the ice tray and Pour water into the ice trays and the water level shall not exceed the top line as the follow picture shows.

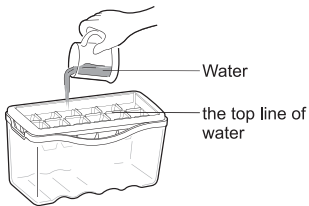

3. Place the ice maker in its original position. When ice cubes form, you can take out the ice cubes for direct use or drop off the ice cubes into the ice storing box for future use.



## 5. Water Dispenser

The water dispenser, located in the fridge door, is for storing drinking water. With this appliance you can obtain chilled water easily without opening the refrigerator. You should be informed of following tips.

### ● Before using

Before using this appliance for the first time, you should use it as follows.

1. Hold the two sides of the water tank tightly, then pull up the water tank by shaking up and down.
2. Unscrew the head, then clean it and the inside of water tank.

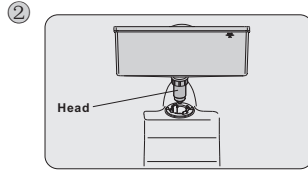
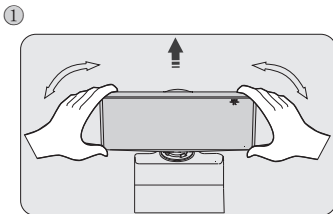

### ● Assembling

Before assembling, please drain the water inside the tank, and check whether the washer is reversed or not.

1. Insert the head into the hole.
2. Fit the tank along the guides on the door.
3. Press down on the two side of the tank.
4. When you hear a click sound, that means the installation is completed.

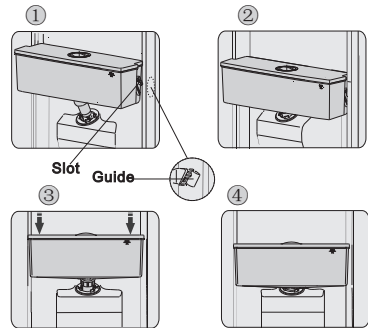

### Warning!

1. Be careful not to press on the head;
2. When fitting the water tank, ensure the head inserted into the hole first;
3. If you found the washer reversed, or loosed when removing the tank, you must take off the fixed holder by contrarotating it first, then put the washer to the correct position, and install the fixed holder at last.

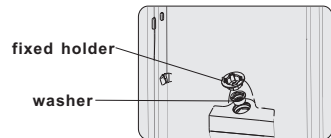

wrong position

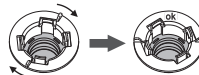

correct position

### ● Filling water

Before you fill the drinking water into the water tank, ensure that the water tank is steady and in a correct position.

#### Caution!

Fill with water up to 3L (which is suggested), and not above the level. Otherwise, it may overflow when the lid is close.

We recommend that you fill the water by the following ways.

1. Remove the small lid and fill water from the inlet of the large lid.
2. Remove the cover of the tank, and then fill water inside directly.

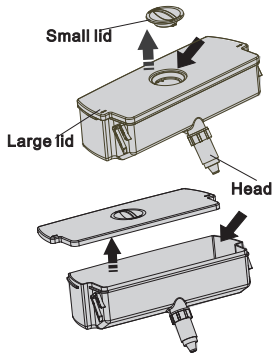

#### Warning!

Don't touch other parts of the appliance when filling water, it may cause the water leakage.

### ● Dispensing water

1. Make sure the cover of the water tank is fitted on.
2. Close the fridge door and check the dispenser.

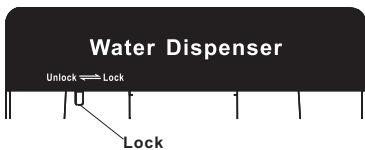

Before you dispense the water, make sure the lock device is on "UNLOCK" situation.

#### Warning!

The lock is defined as "child lock". Don't push the dispenser lever forward strongly, when the dispenser is on "LOCK" situation, it may damage the mechanism.

### ● Receiving Water

You should use the correct cups to receive water underneath the water dispenser.

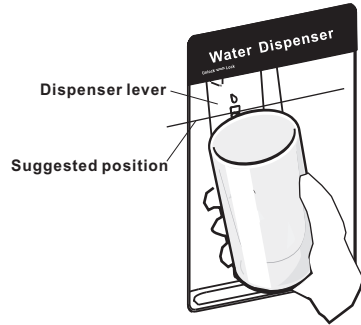

#### Warning!

Don't push the dispenser lever forward without cup, it may cause the water leak from the dispenser.

### ● Cleaning

1. Put the water tank out of the door carefully, and then wash the tank, lid, and head lightly in water.
2. After you have successfully cleaned the appliance, you should dry it by natural drying or using the dryer.
3. If you have used the water dispenser for many times, the water in the receiving tank may drop on the floor, which may make your floor wet, and you should clean the tank with dry towel regularly before overflow.



## Helpful hints and tips

### Energy saving tips

We recommend that you follow the tips below to save energy.

- Try to avoid **keeping the door open for long periods**.

- Ensure the appliance is away from any sources of heat (Direct sunlight, electric oven or cooker etc)
- Don't set the temperature colder than necessary.

- Don't store warm food or evaporating liquid in the appliance.

- Place the appliance in a well ventilated, humidity free room. Please refer to Installing your new appliance chapter.

- If the diagram shows the correct combination for the drawers, crisper and shelves, do not adjust the combination as this is designed to be the most energy efficient configuration.

- If the diagram shows the correct combination for the drawers, crisper and shelves, do not adjust the combination as this is designed to be the most energy efficient configuration.

### Hints for refrigeration

- Don't place hot food directly into the refrigerator or freezer, the internal temperature will increase resulting in the compressor to work harder.

- **Cover or wrap food ,particulary if it has a strong flavor.**

- **Place food carefully so that air can circulate freely around it.**

- Meat (All Types) Wrap in polythene food: wrap and place on the glass shelf above the vegetable drawer. Always follow food storage times and use by dates suggested by

manufacturers.

- Cooked food, cold dishes, etc.: They should be covered and may be placed on any shelf.

- Fruit and vegetables:

They should be stored in the **fresh** drawer provided.

- Butter and cheese:

**Should be wrapped in airtight foil or plastic film wrap.**

- It is recommended to label and date each frozen package in order to keep track of the storage times.

### Hints for the storage of frozen food

- Ensure that frozen food has been stored correctly by the food retailer

- Once defrosted, food will deteriorate rapidly and should not be re-frozen. Do not exceed the storage period indicated by the food manufacturer.

### Switching off your appliance

If the appliance needs to be switched off for an extended period, the following steps should be taken prevent mould on the appliance.

1. Remove all food.

2. Remove the power plug from the mains socket.

3. Clean and dry the interior thoroughly.

4. Ensure that all the doors are wedged open slightly to allow air to circulate.



## Cleaning and care

For hygienic reasons the appliance (including exterior and interior accessories) should be cleaned regularly at least every two months.

Caution! The appliance must not be connected to the mains during cleaning **as there is a danger of electrical shock !**

Before cleaning switch the appliance off and remove the plug from the mains socket.

### Exterior cleaning

To maintain good appearance of your appliance, you should clean it regularly.

-Wipe the digital panel and display panel with a clean, soft cloth.-

-Spray water onto the cleaning cloth instead of spraying directly on the surface of the appliance. This helps ensure an even distribution of moisture to the surface.

-Clean the doors, handles and cabinet surfaces with a mild detergent and then wiped dry with a soft cloth.

### Caution!

-Do not use sharp objects as they are likely to scratch the surface.

-Do not use Thinner, Car detergent, Clorox, ethereal oil, abrasive cleansers or organic solvent such as Benzene for cleaning. They may damage the surface of the appliance and may cause fire.

### Interior cleaning

You should clean the appliance interior regularly. It will be easier to clean

when food stocks are low. Wipe the inside of the fridge freezer with a weak solution of bicarbonate of soda, and then rinse with warm water using a wrung-out sponge or cloth. Wipe completely dry before replacing the shelves and baskets. Thoroughly dry all surfaces and removable parts.

### Door seals cleaning

Take care to keep door seals clean. Sticky food and drinks can cause seals to stick to the cabinet and tear when you open the door. Wash seal with a mild detergent and warm water. Rinse and dry it thoroughly after cleaning.

Caution! Only after the door seals are completely dry should the appliance be powered on.

### Replacing the LED light

**Warning:** The LED light must not be replaced by the user! If the LED light is damaged, consult a qualified, registered electrician for assistance.

## Troubleshooting

If you experience a problem with your appliance or are concerned that the appliance is not functioning correctly, you can carry out some easy checks before calling for **service, please see below**.

**Warning!** Do not try to repair the appliance yourself. If the problem persists after you have made the checks mentioned below, contact a qualified electrician, authorized service engineer or the shop where you purchased the product.

Problem	Possible cause & Solution
Appliance is not working correctly	Check whether the power cord is plugged into the power outlet properly.
	Check the fuse or circuit of your power supply, replace if necessary.
	The ambient temperature is too low. Try setting the chamber temperature to a colder level to solve this problem.
	It is normal that the freezer is not operating during the automatic defrost cycle, or for a short time after the appliance is switched on to protect the compressor.
Odours from the compartments	The interior may need to be cleaned
	Some food, containers or wrapping cause odours.
Noise from the appliance	The sounds below are quite normal: <ul style="list-style-type: none"> <li>●Compressor running noises.</li> <li>●Air movement noise from the small fan motor in the freezer compartment or other compartments.</li> <li>●Gurgling sound similar to water boiling.</li> <li>●Popping noise during automatic defrosting.</li> <li>●Clicking noise before the compressor starts.</li> </ul>
	Other unusual noises are due to the reasons below and may need you to check and take action: The cabinet is not level. The back of appliance touches the wall. Bottles or containers fallen or rolling.
The motor runs continuously	It is normal to frequently hear the sound of the motor, it will need to run more when in following circumstances: <ul style="list-style-type: none"> <li>● Temperature setting is set colder than necessary</li> <li>● Large quantity of warm food has recently been stored within the appliance.</li> <li>●The temperature outside the appliance is too high.</li> <li>●Doors are kept open too long or too often.</li> <li>●After your installing the appliance or it has been switched off for a long time.</li> </ul>
A layer of frost occurs in the compartment	Check that the air outlets are not blocked by food and ensure food is placed within the appliance to allow sufficient ventilation. Ensure that door is fully closed. To remove the frost, please refer to cleaning and care chapter.

Temperature inside is too warm	You may have left the doors open too long or too frequently; or the doors are kept open by some obstacle; or the appliance is located with insufficient clearance at the sides, back and top
Temperature inside is too cold	Increase the temperature by following the "Display controls" chapter.
Door can't be closed easily	Check whether the top of the refrigerator is tilted back by 10-15mm to allow the doors to self close, or if something inside is preventing the doors from closing.
Water drips on the floor	The water pan (located at the rear bottom of the cabinet) may not be properly leveled, or the draining spout (located underneath the top of the compressor depot) may not be properly positioned to direct water into this pan, or the water spout is blocked. You may need to pull the refrigerator away from the wall to check the pan and spout.
The light is not working	<ul style="list-style-type: none"> <li>●The LED light may be damaged. Refer to replace LED lights in cleaning and care chapter.</li> <li>●The control system has disabled the lights due to the door being kept open too long, close and reopens the door to reactivate the lights.</li> </ul>

## Disposal of the appliance

It is prohibited to dispose of this appliance as household waste.

### Packaging materials

Packaging materials with the recycle symbol are recyclable. Dispose of the packaging into a suitable waste collection container to recycle it.

### Before disposal of the appliance

1. Pull out the mains plug from the mains socket.
2. Cut off the power cord and discard with the mains plug

Warning! Refrigerators contain refrigerant and gases in the insulation. Refrigerant and gases must be disposed of professionally as they may cause eye injuries or ignition. Ensure that tubing of the refrigerant circuit is not damage prior to proper disposal.

Correct Disposal of this product	
	<p>This marking indicates that this product should not be disposed with other household wastes throughout the EU. To prevent possible harm to the environment or human health from uncontrolled waste disposal, recycle it responsibly to promote the sustainable reuse of material resources. To return your used device, please use the return and collection systems or contact the retailer where the product was purchased. They can take this product for environmental safe recycling.</p>

**Fridgemaster Technical Helpline  
and Service Centre -Telephone**

**0845 050 8536**

# fridgemaster

FRIDGEMASTER  
Unit 2 Meadow Court  
Millshaw Lane Leeds,  
West Yorkshire,  
LS11 8LZ,  
United Kingdom

For service and repairs please contact  
the Fridgemaster Technical Helpline on:  
0845 0508536

[Fridgemaster@0800repair.com](mailto:Fridgemaster@0800repair.com)



This symbol on the product or in the instructions means that your electrical and electronic equipment should be disposed at the end of its life separately from your household waste. There are separate collection systems for recycling in the EU. For more information, please contact the local authority or your retailer where you purchased the product.

