

Living White Plastic Slow Close Toilet Seat

Components

Fittings

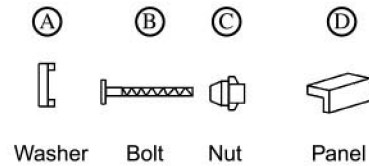
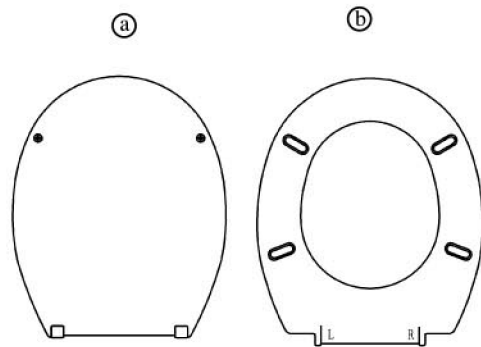

Hinge

IMPORTANT

1. Read these instructions carefully and familiarise yourself with the procedure before assembling the unit.
2. Check that you have all the component parts following the list on the back cover and familiarise yourself with each part before proceeding.
3. Take all the fittings out of the plastic bag and separate them into their groups.
4. Ensure you have enough space to lay out all the parts before assembly.
5. To avoid scratching it is recommended that you assemble the unit on a soft level surface.

Simple Assembly Instruction - Please keep for future reference

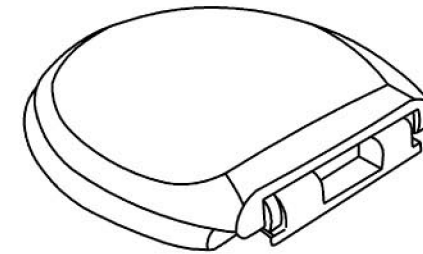

Art. No. 8330875

This product contains an antibacterial treatment - Titanium dioxide (nano).
Please retain this information for future reference.

Assembly Instructions

Stage 1 - Fitting the Support

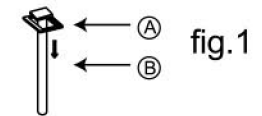

fig.1

IMPORTANT: Before fitting this unit carefully check your Toilet bowl can match the parts and fittings of this unit and the Seat size matches your bowl size.



fig.2

1. Insert the threaded fixing bolts (B) into the washer (A)

See fig. 1.

2. Insert the washer into the backside of hinge.

See fig. 2.

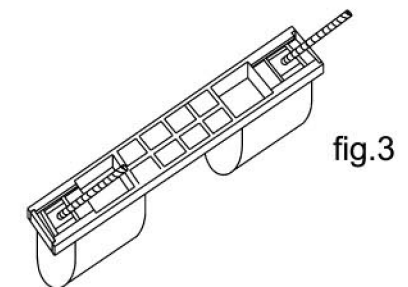

fig.3

3. Adjust the bolt leftward and rightward until they are aligned with the holes in the toilet pan

See fig. 3.

4. Embed panel (D) on both sides of the hinge.

See fig. 4.



fig.4

Assembly Instructions

Stage 2 - Fitting the Seat

1. Place the Toilet Seat on the toilet bowl ensuring the screws drop through the holes at the back of the bowl.

See fig. 5.

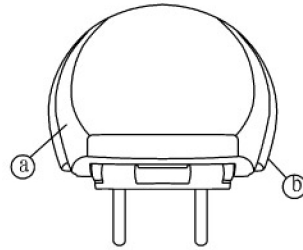

2. Centre the toilet seat on the bowl and ensure the Screws ② are well fitted.

See fig. 5.

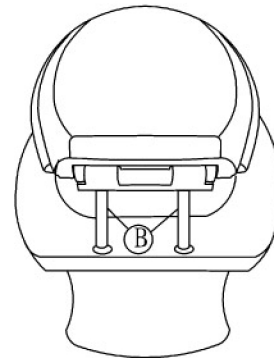

fig.5

3. Use Plastic Nuts ③ to fix the Toilet Seat onto the bowl.

See fig. 6.

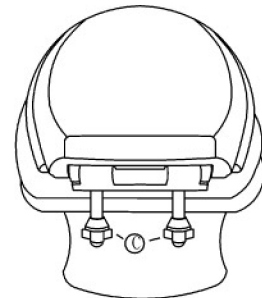

fig.6

NOTE: Before use always make sure the unit is secure and the screws are tight.

Assembly Instructions

Stage 3 - Finishing the Unit

Soft Close:

- This Toilet Seat has Soft Close feature. It will close the Cover ① or Seat ② slowly. To close, gently pull the seat or cover forward and allow it to fall forward by itself, open in the normal way.

See fig. 7.

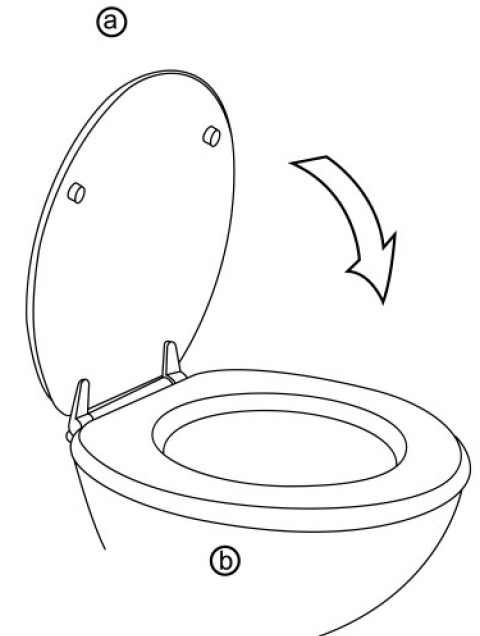

fig.7

Care and Maintenance

Safety

To avoid any risk of suffocation to animals or children dispose of the plastic bags immediately.

Cleaning

As with all surfaces clean with a damp cloth and mild detergent, do not use bleach or abrasive products.

Fitting

From time to time please ensure there are no loose nuts on the product.