

## OWNER'S MANUAL

# DRYER



**Before beginning installation, read these instructions carefully. This will simplify installation and ensure that the product is installed correctly and safely. Leave these instructions near the product after installation for future reference.**

EN ENGLISH

FDJ608W



MFL71424304  
Rev.00\_050319

[www.lg.com](http://www.lg.com)

# TABLE OF CONTENTS

This manual may contain images or content different from the model you purchased. This manual is subject to revision by the manufacturer.

<b>SAFETY INSTRUCTIONS .....</b>	<b>3</b>
IMPORTANT SAFETY INSTRUCTIONS .....	3
Disposal of Your Old Appliance .....	8
<b>INSTALLATION .....</b>	<b>9</b>
Specifications .....	9
Accessories (Optional) .....	9
Installation Place Requirements .....	10
Stacking Installation Instructions (Optional) .....	11
Reversing the door .....	13
<b>OPERATION .....</b>	<b>15</b>
Using the Appliance .....	15
Sorting Laundry .....	16
Control Panel .....	17
Programme Table .....	18
Option Programme .....	20
Rack Dry (Optional) .....	21
<b>SMART FUNCTIONS .....</b>	<b>22</b>
Using LG SmartThinQ Application .....	22
Using Smart Diagnosis™ .....	25
<b>MAINTENANCE .....</b>	<b>26</b>
Cleaning the Lint Filter .....	26
Emptying the Water Container .....	27
Cleaning the Cool Air Inlet Grill .....	27
Wiping the Moisture Sensor .....	27
<b>TROUBLESHOOTING .....</b>	<b>28</b>
Diagnosing Problems .....	28
Error Codes .....	32
<b>WARRANTY .....</b>	<b>33</b>
<b>OPERATING DATA .....</b>	<b>34</b>

The following safety guidelines are intended to prevent unforeseen risks or damage from unsafe or incorrect operation of the appliance. The guidelines are separated into 'WARNING' and 'CAUTION' as described below.

 This symbol is displayed to indicate matters and operations that can cause risk. Read the part with this symbol carefully and follow the instructions in order to avoid risk.

 **WARNING**

This indicates that the failure to follow the instructions can cause serious injury or death.

 **CAUTION**

This indicates that the failure to follow the instructions can cause the minor injury or damage to the product.

## IMPORTANT SAFETY INSTRUCTIONS

 **WARNING**

**To reduce the risk of explosion, fire, death, electric shock, injury or scalding to persons when using this product, follow basic precautions, including the following:**

### Children in the Household

This appliance is not intended for use by persons (including children) with reduced physical, sensory or mental capabilities, or lack of experience and knowledge, unless they have been given supervision or instruction concerning use of the appliance by a person responsible for their safety. Children should be supervised to ensure that they do not play with the appliance.

## **For use in Europe:**

This appliance can be used by children aged from 8 years and above and persons with reduced physical, sensory or mental capabilities or lack of experience and knowledge if they have been given supervision or instruction concerning use of the appliance in a safe way and understand the hazards involved. Children shall not play with the appliance. Cleaning and user maintenance shall not be made by children without supervision.

Children of less than 3 years should be kept away unless continuously supervised.

## **Installation**

- Make sure the appliance is properly installed, grounded, and adjusted by qualified service personnel according to the installation instructions.
- Never attempt to operate the appliance if it is damaged, malfunctioning, partially disassembled, or has missing or broken parts, including a damaged cord or plug.
- This appliance should only be transported by two or more people holding the appliance securely.
- Do not install the appliance in a damp and dusty place. Do not install or store the appliance in any outdoor area, or any area that is subject to weathering conditions such as direct sunlight, wind, or rain or temperatures below freezing.
- Tighten the drain hose to avoid separation.
- If the power cord is damaged or the hole of the socket outlet is loose, do not use the power cord and contact an authorized service centre.
- Do not plug multiple socket outlets, an extension power cable or adapter with this appliance.
- Items such as foam rubber (latex foam), shower caps, waterproof textiles, rubber backed articles and clothes or pillows fitted with foam rubber pads should not be dried in the appliance.

- This appliance must not be installed behind a lockable door, a sliding door or a door with a hinge on the opposite side to that of the appliance, in such a way that a full opening of the appliance door is restricted.
- This appliance must be grounded. In the event of malfunction or breakdown, grounding will reduce the risk of electric shock by providing a path of least resistance for electric current.
- This appliance is equipped with a power cord having an equipment-grounding conductor and a grounding power plug. The power plug must be plugged into an appropriate socket outlet that is installed and grounded in accordance with all local codes and ordinances.
- Improper connection of the equipment-grounding conductor can result in risk of electric shock. Check with a qualified electrician or service personnel if you are in doubt as to whether the appliance is properly grounded.
- Do not modify the power plug provided with the appliance. If it does not fit the outlet, have a proper outlet installed by a qualified electrician.
- The appliance must not be supplied through an external switching device, such as a timer, or connected to a circuit that is regularly switched on and off by a utility.

## **Operation**

- Do not attempt to separate any panels or disassemble the appliance. Do not apply any sharp objects to the control panel in order to operate the appliance.
- Do not repair or replace any part of the appliance. All repairs and servicing must be performed by qualified service personnel unless specifically recommended in this Owner's Manual. Use only authorized factory parts.
- Keep the area underneath and around the appliance free of combustible materials such as lint, paper, rags, chemicals, etc.
- Do not put animals, such as pets into the appliance.
- Do not leave the appliance door open. Children may hang on the door or crawl inside the appliance, causing damage or injury.

- Never reach into the appliance while it is operating. Wait until the drum has completely stopped.
- Do not put in, wash or dry articles that have been cleaned in, washed in, soaked in, or spotted with combustible or explosive substances (such as wax, oil, paint, gasoline, degreasers, drycleaning solvents, kerosene, vegetable oil, cooking oil, etc.). Improper use can cause fire or explosion.
- In case of flood, disconnect the power plug and contact the LG Electronics customer information centre.
- Do not push down the door excessively, when the appliance door is open.
- Use new hose or hose-set supplied with the appliance. Reusing old hoses can cause a water leak and subsequent property damage.
- Do not touch the door during a high temperature programme.
- Do not use flammable gas and combustible substances (benzene, gasoline, thinner, petroleum, alcohol, etc.) near the appliance.
- If the drain hose or inlet hose is frozen during winter, use it only after thawing.
- Keep all washing detergents, softener and bleach away from children.
- Do not touch the power plug or the appliance controls with wet hands.
- Do not bend the power cable excessively or place a heavy object on it.

## **Maintenance**

- Securely plug the power plug in the socket outlet after completely removing any moisture and dust.
- Disconnect the appliance from the power supply before cleaning the appliance. Setting the controls to the OFF or stand by position does not disconnect this appliance from the power supply.
- Do not spray water inside or outside the appliance to clean it.
- Never unplug the appliance by pulling on the power cable. Always grip the power plug firmly and pull straight out from the socket outlet.

## Technical Safety for Using the Dryer



### **WARNING - To avoid a fire Risk of Fire and Flammable Materials**

- In the appliance enclosure or in the built-in structure, keep ventilation openings clear of obstruction. If not, it can result in a fire.
- This appliance contains R290, a refrigerant that is environmentally friendly but flammable. Do not damage the refrigerant circuit, keep open flame and ignition sources away from the appliance.
- Do not dry unwashed items in the appliance.
- Fabric softeners, or similar products, should be used as specified by the fabric softener instructions.
- Remove all objects from pockets such as lighters and matches.
- Never stop the appliance before the end of the drying cycle unless all items are quickly removed and spread out so that the heat is dissipated.
- The appliance is not to be used if industrial chemicals have been used for cleaning.
- Items that have been soiled with substances such as cooking oil, vegetable oil, acetone, alcohol, petroleum, kerosene, spot removers, turpentine, waxes and wax removers should be washed in hot water with an extra amount of detergent before being dried in the appliance.
- Do not drink the condensed water. Failure to do so may result in food-borne illnesses.
- If the supply cord is damaged, it must be replaced by the manufacturer or its service agents or similarly qualified person in order to avoid a hazard.
- The lint trap has to be cleaned frequently.
- Lint must not to be allowed to accumulate around the appliance.
- Do not spray dry cleaning detergent directly onto the appliance or use the appliance to dry clothes left with dry cleaning detergent.

- Do not dry clothes stained with oil substances. Oil substances (including edible oils) stained on clothes cannot be completely removed even after washing with water.
- The appliance must not be supplied through an external switching device, such as a timer, or connected to a circuit that is regularly switched on and off by a utility.
- Remove clothes from the appliance immediately when drying is complete or the power is turned off during the drying process. Leaving clothes that have been dried in the appliance unattended could result in fire. Clothes removed from the appliance after drying could result in fire. Remove clothes immediately after drying, and then hang or lay the clothes flat to cool.

## Disposal

- Before discarding an old appliance, unplug it. Cut off the cable directly behind the appliance to prevent misuse.
- Dispose of all packaging materials (such as plastic bags and styrofoam) away from children. The packaging materials can cause suffocation.
- Remove the door before disposing of or discarding this appliance to avoid the danger of children or small animals getting trapped inside.

## Disposal of Your Old Appliance



- This crossed-out wheeled bin symbol indicates that waste electrical and electronic products (WEEE) should be disposed of separately from the municipal waste stream.
- Old electrical products can contain hazardous substances so correct disposal of your old appliance will help prevent potential negative consequences for the environment and human health. Your old appliance may contain reusable parts that could be used to repair other products, and other valuable materials that can be recycled to conserve limited resources.
- You can take your appliance either to the shop where you purchased the product, or contact your local government waste office for details of your nearest authorised WEEE collection point. For the most up to date information for your country please see [www.lg.com/global/recycling](http://www.lg.com/global/recycling).

This dryer contains the refrigerant R290 : 0.145 kg Hermetically sealed.



## Specifications

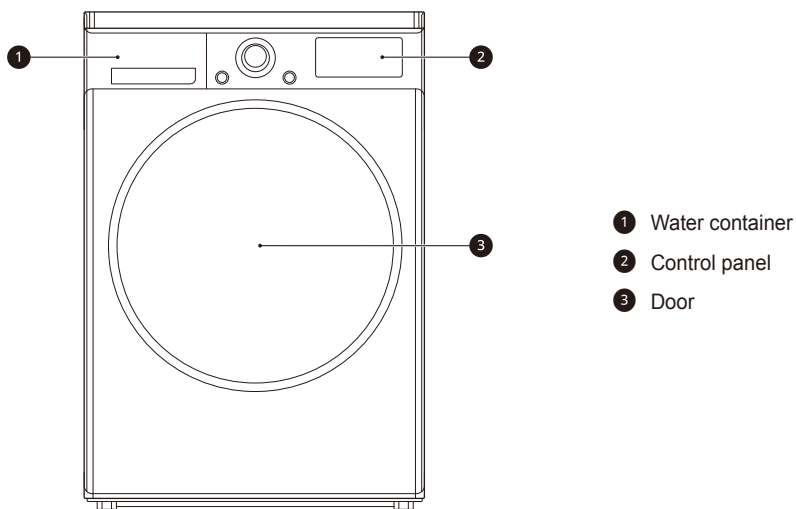

- 1 Water container
- 2 Control panel
- 3 Door

Model	FDJ608W
Power supply	220 - 240 V~, 50 Hz
Size	600 mm (W) X 690 mm (D) X 850 mm (H)
Product weight	56 kg
Allowable temperature	5 - 35 °C
Max. capacity	8 kg

- Appearance and specifications may vary without notice to improve the quality of the appliance.

## Accessories (Optional)

Please contact LG Electronics Customer Information Centre or visit the LG Website at <http://www.lg.com> for purchase.



Condensing Drain Hose and Hose Holder

**Model : DH1N**  
(Sold separately)

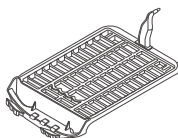

Dry Rack

**Model : DR1N**  
(Sold separately)

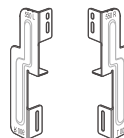

Stacking Kit

**Model : DT1W**  
(Sold separately)

# Installation Place Requirements

## Location

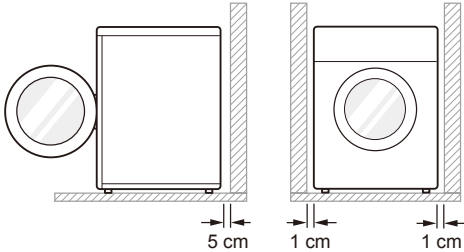

**Level floor :** Allowable slope under the entire appliance is 1°.

**Power outlet :** Must be within 1.5 meters of either side of the location of the appliance.

- Do not overload the outlet with more than one appliance.

**Additional Clearance :** For the wall, 5 cm: rear /1 cm: right & left side

- Do not place or store laundry products on top of the appliance at any time. These products may damage the finish or controls.

## WARNING

- This appliance contains R290, a refrigerant that is environmentally friendly but flammable. Do not damage the refrigerant circuit, keep open flame and ignition sources away from the appliance.

## NOTE

- For better drying performance, please keep the rear of the appliance away from wall.
- Do not install the appliance where there is a risk of frost or dust.
- The appliance may not be able to operate properly or may be damaged by freezing of condensed water in the pump and drain hose.

- Do not install the appliance next to a high-temperature appliance like refrigerator, oven or stove etc, which can cause poor drying performance and programme duration, and adversely affect the proper functioning of the compressor. The appliance performs best at a room temperature of 23 °C.

## Positioning

- Install the appliance on a flat hard floor.
- Make sure that air circulation around the appliance is not impeded by carpets, rugs, etc.
- Never try to correct any unevenness in the floor with pieces of wood, cardboard or similar materials under the appliance.
- Do not install the appliance in rooms where freezing temperatures may occur. Frozen hoses may burst under pressure. The reliability of the electronic control unit may be impaired at temperatures below freezing point.
- If the appliance is delivered in winter and temperatures are below freezing, place the appliance at room temperature for a few hours before putting it into operation.
- Please ensure that when the appliance is installed, it is easily accessible for an engineer in the event of a breakdown.
- With the appliance installed, adjust all four feet using a spanner to ensure the appliance is stable, and a clearance of approximately 20 mm is left between the top of the appliance and the underside of any work-top.

## Ventilation Requirement

### WARNING

- In the appliance enclosure or in the built-in structure, keep ventilation openings clear of obstruction. If not, it can result in a fire.
- Alcove or under counter
  - Ensure air flow of 3.17 m<sup>3</sup>/min through the appliance
- Closet
  - Closet door must have 2 (louvered) openings, each having a minimum area of 387 cm<sup>2</sup>, located 8 cm from bottom and top of door.

## WARNING

- Avoid installing the appliance around a heat source. The rear side of the appliance must be well ventilated. Failure to follow these instructions may result in problems.
- The appliance should not be installed next to a refrigeration appliance.
- The appliance is not designed for maritime use or for use in mobile installations such as caravans, aircraft etc.

## Electrical Connection

- Do not use an extension cord or double adapter.
- Always unplug the appliance after use.
- Connect the appliance to an earthed socket in accordance with current wiring regulations.
- The appliance must be positioned so that the plug is easily accessible.

## Stacking Installation Instructions (Optional)

Your dryer can be placed on top of an LG washing machine and securely fixed with a stacking kit. This installation must be conducted by qualified service personnel to ensure it has been installed correctly.

### Stacking Kit

In order to stack this dryer, an LG stacking kit is required.

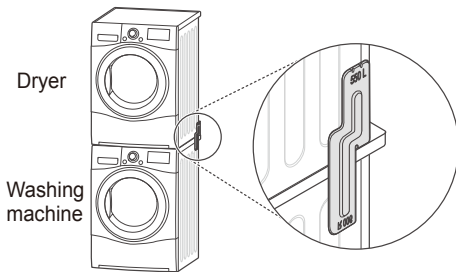

This dryer may only be stacked on top of an LG washing machine. Do not attempt to stack this dryer on any other washing machine, as damage, injury or property damage could result.

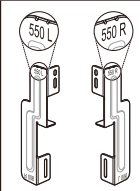
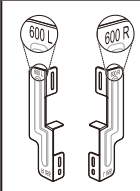
	Washing Machine Top plate size	
	550 mm	600 mm
<b>Shape and assembly direction</b>		

## Installation Procedure

- 1 Place the LG dryer on the LG washing machine.
- 2 Remove the two screws from the bottom of the rear cover on each side as illustrated below.

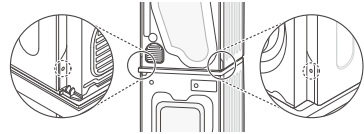

- 3 Align the stacking kit holes and the rear cover holes.

- 3-1) 600 mm

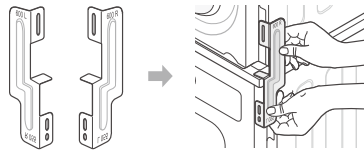

- 3-2) 550 mm

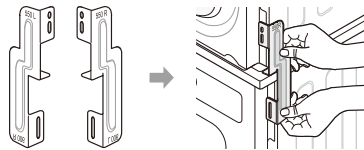

- 4 Fasten the two screws that were removed earlier from the dryer to the stacking kit.

- 5 Use the four screws in the accessory box (16 mm) to assemble the washing machine rear cover and stacking kit.
- 6 The procedure for the opposite side will be the same.

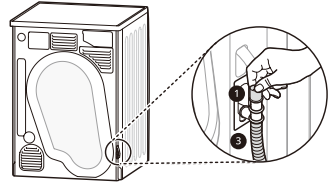

## **!** WARNING

- Incorrect installation can cause serious accidents.
- The weight of the appliance and the height of installation make the stacking procedure too risky for one person. This procedure should be performed by two or more qualified service personnel.
- The appliance is not suitable for a built-in installation. Please do not install as a built-in appliance.
- Do not operate if the appliance is not properly stacked.

## Condensed Water Drain-out (Optional)

Normally, condensed water is pumped up to the water container where water is collected until manually emptied. Water can also be drained out directly to a mains drain, especially when the dryer is stacked on top of a washing machine. With a connecting kit for the mains drain hose, simply change the water path and re-route to the drainage facility as below:

- 1 Separate the anti-backflow lid (1) and the water container hose (2) from the connecting kit.

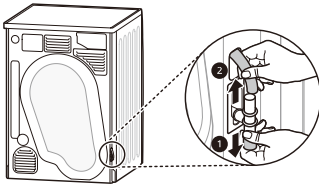

- 2 Attach the anti-backflow lid (1) to the head of the connecting kit and then connect the drain hose (2) to the opposite side of the connecting kit.

## **!** CAUTION

- If the hose is installed in a way that leaves it bent or pinched, drainage may not function properly.

## Leveling the appliance

Leveling the appliance prevents unnecessary noise and vibration. Place the appliance on a solid, level floor.

If the appliance is not properly level, adjust the front leveling feet as necessary.

Turn them clockwise to raise and counter-clockwise to lower until the appliance no longer wobbles, both front-to-back and side-to-side and corner-to-corner.

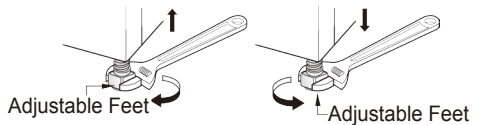
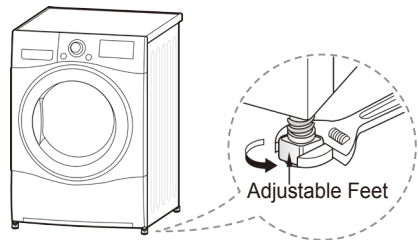

## Diagonal Check

- When pushing down the edges of the top plate diagonally, the appliance should not move up and down at all (Check both directions). If the appliance rocks when pushing the top plate diagonally, adjust the feet again.

## Reversing the door

You can reverse the door for your convenience.

### WARNING

- Do not reverse the door while the appliance is stacked on a washing machine.
- Before removing the hinge screws, have an assistant support the weight of the door. The door could fall on the floor due to the weight of the door.
- For safety reasons, two or more people need to work together to reverse the door.

### NOTE

- The appearance of the screws varies and the screws must be inserted differently depending on the position. Make sure the screw is properly selected before tightening.

- 1 Open the door and remove 2 screws on the door hinge. After removing the screws, put the door down carefully with the front side facing down to the floor.

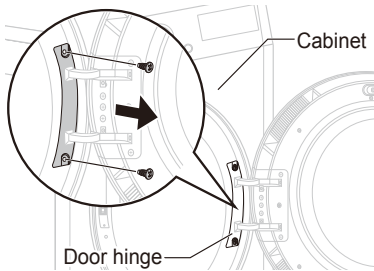

### WARNING

- Remove the lower screw first. The door may fall on to the floor due to its weight and the door can be damaged.

- 2 Remove 8 screws on the hinge assembly from the door.
  - There are 6 screws on the front and 2 screws on the side.

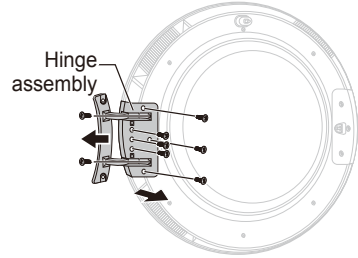

- 3 Remove the 3 screws from the door latch assembly which is fixed between the door and the hinge assembly, and then remove the screw which is fixed on the door hook.

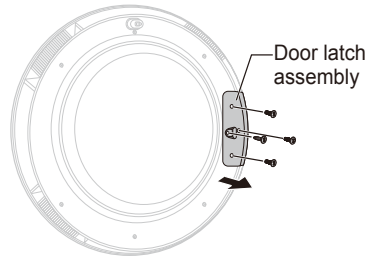

- 4 Switch between the position the hinge assembly and door latch assembly and then tighten the screws in reverse order.
  - Tighten the screw in proper position referring from 2 to 4 steps.

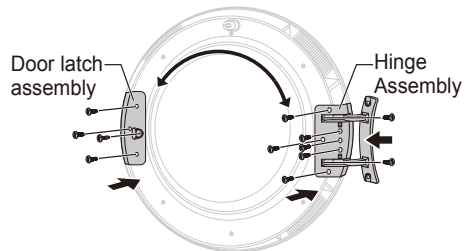

- 5** Remove the door catch from the appliance frame by removing 2 screws and then assemble them on the opposite side.

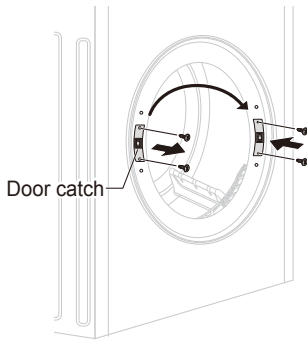

- 6** Remove the 2 decorative screws from the appliance frame and then assemble them on opposite side.

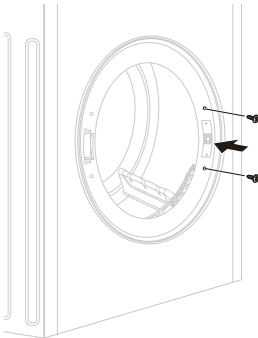

- 7** Install the door with the screws removed in step 1 and then check the door closes properly.

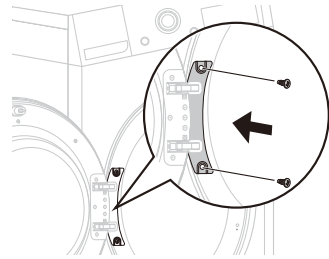

## Using the Appliance

Before the first cycle, set the appliance to dry for five minutes to warm up the drum. Open the door between loads the first few times you use the appliance to allow any odours from the interior of the appliance to disperse.

- 1 Ensure the lint filter and water container are clean.
  - The lint filter is inside the door rim. It needs to be cleaned before each drying cycle.
  - Open the door and ensure the lint filter is clean. If it is not, please clean the lint filter.

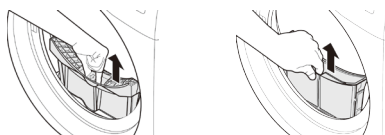

- Also check if the water container needs to be emptied for optimum drying results.

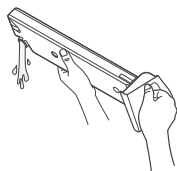

## WARNING

- Do not drink the condensed water.

## NOTE

- In some instances, LED window may display  (Empty water symbol) and the appliance may stop because the water container is full.

- 2 Place laundry into the drum after sorting.
  - The clothes should be sorted by fabric type and dryness level and all the strings and belts of clothes should be well tied and fixed before being put into the drum. Push the laundry to the back to keep it away from the door seal. Otherwise, the door seal and clothes may be damaged. Close the door.

## CAUTION

- Be careful not to trap laundry between the door and rubber seal.

- 3 Turn the power on.
  - Press the **Power** button. The indicator icon above the button will become illuminated, indicating that the appliance is all set to run.



- 4 Select the drying programme you want.
  - You can choose a programme by turning the programme selector knob until the required programme is indicated.
  - If you press the **Start/Pause** button without choosing a programme, the appliance will proceed with the **Cotton** programme. Please refer to the programme table for the detailed information.



- 5 Press the **Start/Pause** button.
  - When you press the **Start/Pause** button, the appliance ventilates the inside of the drum for 10 seconds in order to get the appliance ready for drying operation.



- 6 After the cycle has finished, open the door and remove the laundry.

- 7 Turn off the appliance.
  - Press the **Power** button.

## CAUTION

- Be careful! The drum inside may still be hot.
- The appliance must not be used for purposes other than those for which it was designed.

## NOTE

- The final part of a tumble dryer cycle occurs without heat (cool down cycle) to ensure that laundry is left at a temperature that ensures the laundry will not be damaged.
- A high atmospheric temperature and a small room may both increase drying time as well as energy consumption.

## Sorting Laundry

Clothes have their own wash care labels, so drying according to the wash care label is recommended.

Not only that, the laundry must be sorted according to size and type of fabric.

For the best drying performance and most efficient energy usage, do not overload the appliance.

### Woollens

- Dry woollens on the Wool programme. Be sure to follow fabric care label symbols first. Wool may not be completely dried from the cycle, so do not repeat drying. Pull woollens to their original shape and dry them flat.

### Woven and Loopknit Materials

- Some woven and loopknit materials may shrink, depending on quality.

### Non-Iron and Synthetics

- Do not overload the appliance. Take out non-iron items as soon as the appliance stops to reduce creases.

### Baby Clothes and Night Gowns















- Always check fabric care labels.

## Rubber and Plastics

- Do not dry any items made from or containing rubber or plastics such as:
  - Aprons, Bibs and Chair Covers
  - Curtains and Table Clothes
  - Bathmats

## Fiberglass

- Do not dry fiberglass items in the appliance. Glass particles left in the appliance may be subsequently picked up by your clothes in later cycles.

Icon	Description
	Dry
	Tumble dry
	Permanent Press / Crease resistant
	Gentle / Delicate
	Do not tumble dry
	Do not dry
	High heating
	Medium heating
	Low heating
	No Heating / Air
	Line dry / Hang to dry
	Drip dry
	Dry flat
	In the shade



# Control Panel

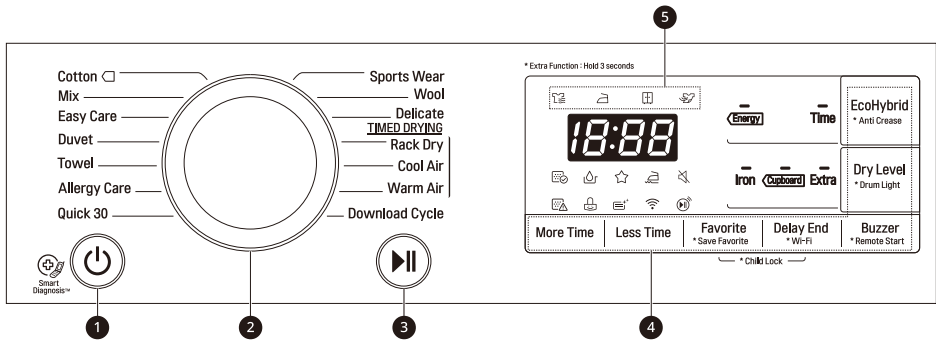

## 1 Power Button

- Press the **Power** button to turn power on and off.
- Press the **Power** button to cancel the Delay End function.

## 2 Programme Selector

- Programmes are available according to the laundry type.
- The lamp will light up to indicate the selected programme.

## 3 Start/Pause Button

- This **Start/Pause** button is used to start or pause a dry cycle.
- When in **Pause**, the power is turned off automatically after 14 minutes.

## 4 Additional Programme Buttons

- Use these buttons to select the desired options for the selected programme.
- In order to use the Remote Start function, refer to **SMART FUNCTIONS**.

## 5 Drying Progress Indicator

- The different indicator icon lights up depending on the drying cycle progress.
  - : This icon lights up when the appliance is in drying progress.

- : This icon lights up when the appliance is in iron drying progress.
- : This icon lights up when the appliance is in cupboard drying progress.
- : This icon lights up when the appliance is in cooling progress.

## Display

- : This icon indicates that the lint filter should be cleaned or is clogged.
  - Cleaning notice: When you press the Power button, the icon will become displayed.
- : This icon indicates that the water container needs to be emptied or is full.
  - Emptying notice: When you press the Power button, this icon will become displayed.
  - Full water notice: The icon will become displayed and a buzzer will sound while the appliance is in operation.
- : This icon indicates the lint filter insertion status. If the lint filter is not inserted, the appliance will not operate and the icon will become displayed.
- : This icon indicates the condenser auto cleaning status. The icon will be displayed during water sprays to the condenser.

# Programme Table

## Drying Programme



Sensor Dry Programmes				
Programme	Laundry Type	Detail	Dry Level	Capacity
				8 kg
Cotton	Towels, dressing gowns and bed linen	For thick and quilted fabrics	Extra	8 kg
	Bath towels, tea towels, underwear and cotton socks	For fabrics that do not need to be ironed	Cupboard	8 kg
	Bed linen, table linen, towels, T-shirts, polo shirts and work clothes	For fabrics that need to be ironed	Iron	8 kg
Mix	Bed linen, table linen, tracksuits, anoraks and blankets	For thick and quilted fabrics that do not need to be ironed	Extra	4 kg
	Shirts and blouses	For fabrics that do not need to be ironed	Cupboard	
	Trousers, dressers, skirts and blouses	For fabrics that need to be ironed	Iron	
Easy Care	Shirts, T-shirts, trousers, under-wear and socks	For polyamide, acrylic, and polyester that do not need to be ironed	Cupboard	3.5 kg
	Shirts, T-shirts, under-wear, anoraks and socks	For polyamide, acrylic, polyester that do need to be ironed	Iron	
Duvet	Beddings, bed sheets	For bulky items	-	2.5 kg
Towel	Towels, Pillowcases	For cotton fabrics which do not need to be ironed	-	4.5 kg
Allergy Care	Cotton, underwear, bed sheets and baby clothes	Helps to remove allergens such as house mites	-	4.5 kg
Quick 30	Light and small items less than 3ea.	For small amount of polyamide, acrylic and polyester items	-	1 kg
Sports Wear	Soccer kit and training wear	For polyester material	-	2 kg
Wool	Wool	For wool fabrics	-	1 kg
Delicate	Silk, fine fabrics and lingerie	For fabrics that are heat-sensitive, such as synthetic fabrics	-	1.5 kg

Timed Drying Programmes				
Programme	Laundry Type	Detail	Dry Level	Capacity
				8 kg
<b>Rack Dry</b>	Silk, wool, delicate lingerie	Refreshes clothes without tumble drying	-	-
<b>Cool Air</b>	All fabrics that need refreshing	Tumbles without heat	-	-
<b>Warm Air</b>	Bath towels, bath robes, dishcloths and acrylic quilted fabrics	Small Items & damp clothing, Everyday items suitable for heat drying	-	-

## CAUTION

- If the load is less than 1 kg, please use the **Warm Air** programme in Timed Drying programmes. Wool items should be dried using the **Wool** programme and heat-sensitive fabrics including silk, underwear and lingerie should be dried using the **Delicate** programme. Please comply with the recommended laundry load when you select your desired programme. Otherwise, your clothes may be damaged.

## NOTE

- Tested in accordance with EN61121 and Directive 932/2012
- Set programme at Cotton Cupboard Energy (Full & Half Load) for test in accordance in conformity with EN61121 and Directive 932/2012
- Standard Cotton programme : Cotton  +  Option (Default) (This is the most efficient programme in terms of the test conditions proposed by EN61121 and Directive 932/2012)
- It is suitable to dry normal wet cotton laundry and it is the most efficient programme in terms of energy consumption for drying wet cotton laundry.
- The test results depend on room temperature, type and amount of load, water hardness and water inlet temperature.
- If the appliance is installed as built under, it may cause performance degradation.
- If the laundry is not spun at a high speed during washing, energy consumption and drying time will increase.

## Option Programme

### Delay End

You can use the Delay End option to delay the finishing time of the drying cycle. It allows you to set delay time from 3 hours to 19 hours.

- 1 Turn the appliance on.
- 2 Select a programme.
- 3 Press the **Delay End** button.
- 4 Set delay hour(s) by pressing the **More Time, Less Time** button.
- 5 Press the **Start/Pause** button.

### Anti Crease

The Anti Crease option prevents creases that are formed when the laundry is not unloaded promptly at the end of the drying cycle. When **Anti Crease** is selected, the appliance repeatedly runs and pauses, giving you two hours to unload the laundry. If the door is opened during the Anti Crease option, the option is cancelled.

### Favorite

The Favorite option allows you to store a customized dry programme for future use.

- 1 Turn the appliance on.
- 2 Select a programme.
- 3 Select the option or additional programme. (**Anti Crease, EcoHybrid** etc.)
- 4 Press and hold the **Favorite** option button for three seconds.

The Favorite option is now stored for future use. To reuse the stored programme, select the **Favorite** option and press the **Start/Pause** button.

### Drum Light

Whilst the appliance is running it is possible to see inside the drum if you select the Drum Light function.

- Press and hold the **Dry Level** button for 3 seconds to activate the Drum Light function.
- Light on : Door is opened.
- Light off : Door is closed. The light is turned off automatically.

### Dry Level

Use this button to select a dryness level for the drying programme.

- 1 Turn the appliance on.
- 2 Select a programme.
- 3 Select a dryness level by pressing the **Dry Level** button repeatedly.

### EcoHybrid

This additional program offers the option of saving energy or time.

- **Energy:** Energy saving option.
- **Time:** Time saving option.

### Child Lock

Use this option to disable the controls. This feature can prevent children from changing cycles or operating the appliance.

### Locking the Control Panel

- 1 Press and hold the **Favorite** and **Delay End** button simultaneously for three seconds.
- 2 A beeper will sound, and CL will appear on the display.
  - When the **Child Lock** is set, all buttons are locked except the **Power** button.

**NOTE**

- Turning off the power or completing all cycles will not reset the child lock function. You must deactivate child lock before you can access any other functions.

**Unlocking the Control Panel**

Press and hold the **Favorite** and **Delay End** button simultaneously for three seconds.

- A beeper will sound and the remaining time for the current programme will reappear on the display.

**Buzzer** 

This option enables you to turn the buzzer sound on and off.

**More Time / Less Time**

Use these buttons with the Manual Dry programmes to manually increase or reduce the drying time.

Press the **More Time** button to increase the selected programme time by five minutes.

Press the **Less Time** button to decrease the selected programme time by five minutes.

**Rack Dry (Optional)**

The Rack Dry is designed for use with laundry that must be dried flat, without tumbling, including sweaters and delicate fabrics.

If you want to use Rack Dry option, a dry rack should be purchased separately. A Dry Rack (Model name : DR1N) is available for purchase from LG Electronics Customer Information Centre or our website at <http://www.lg.com>

- 1 Open the door.
- 2 Insert the hook to the drum centre.

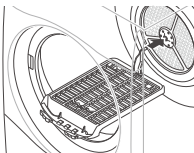

- 3 Place the dryer rack on the structure above the lint filter and press it to complete assembly.

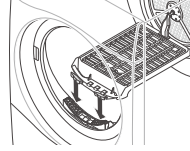

- 4 Place wet items on top of the rack. Allow space around items for air to circulate.
  - The rack does not move, but the drum will rotate.

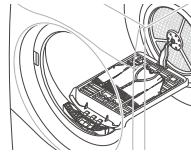



- 5 Close the door.
- 6 Turn power on and select **Rack Dry**.
- 7 Press the **Start/Pause** button.

**NOTE**

- Check the lint filter and remove any lint accumulated from items dried on the rack.
- The **More Time / Less Time** keys can be used to finely adjust the drying time.

## Using LG SmartThinQ Application

### Things to check before using LG SmartThinQ

- For appliances with the  or  logo
- 1 Check the distance between the appliance and the wireless router (Wi-Fi network).
    - If the distance between the appliance and the wireless router is too far, the signal strength becomes weak. It may take a long time to register or installation may fail.
  - 2 Turn off the **Mobile data** or **Cellular Data** on your smartphone.
    - For iPhones, turn data off by going to **Settings** → **Cellular** → **Cellular Data**.

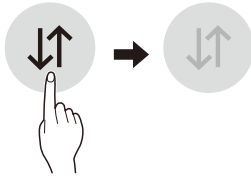

- 3 Connect your smartphone to the wireless router.

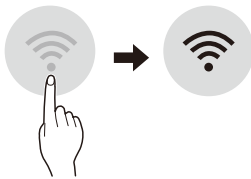

### NOTE

- To verify the Wi-Fi connection, check that **Wi-Fi**  icon on the control panel is lit.
- The appliance supports 2.4 GHz Wi-Fi networks only. To check your network frequency, contact your Internet service provider or refer to your wireless router manual.
- LG SmartThinQ is not responsible for any network connection problems or any faults, malfunctions, or errors caused by network connection.
- If the appliance is having trouble connecting to the Wi-Fi network, it may be too far from the router. Purchase a Wi-Fi repeater (range extender) to improve the Wi-Fi signal strength.
- The Wi-Fi connection may not connect or may be interrupted because of the home network environment.
- The network connection may not work properly depending on the Internet service provider.
- The surrounding wireless environment can make the wireless network service run slowly.
- The appliance cannot be registered due to problems with the wireless signal transmission. Unplug the appliance and wait about a minute before trying again.
- If the firewall on your wireless router is enabled, disable the firewall or add an exception to it.
- The wireless network name (SSID) should be a combination of English letters and numbers. (Do not use special characters.)
- Smartphone user interface (UI) may vary depending on the mobile operating system (OS) and the manufacturer.
- If the security protocol of the router is set to **WEP**, you may fail to set up the network. Please change it to other security protocols (**WPA2** is recommended) and register the product again.

## Installing LG SmartThinQ

Search for the LG SmartThinQ application from the Google Play Store or Apple App Store on a smartphone. Follow instructions to download and install the application.

## Wi-Fi Function

- For appliances with the  or  logo

Communicate with the appliance from a smartphone using the convenient smart features.

## Dryer Cycle (Remote Start, Download Cycle)

Set or download any preferred cycle and operate by remote control.

## Smart Diagnosis™

This function provides useful information for diagnosing and solving issues with the appliance based on the pattern of use.

## Push Alert

When the cycle is complete or the appliance has problems, you have the option of receiving push notifications on a smartphone.

## Energy Monitoring

The dryer energy usage is affected by the cycle and options so you may see some changes in energy usage from one cycle to another.

## Settings

Set the product nickname and delete product.

## NOTE

- If you change your wireless router, Internet service provider, or password, delete the registered appliance from the LG SmartThinQ application and register it again.
- The application is subject to change for appliance improvement purposes without notice to users.
- Functions may vary by model.

## Using Dryer Cycle

### Remote Start

Use a smartphone to control your appliance remotely. You can also monitor your cycle operation so you know how much time is left in the cycle.

#### To Use Remote Start:

- 1 Press the **Power** button.
- 2 Put the laundry in drum.
- 3 Press and hold the **Buzzer** button for 3 seconds to enable the Remote Start function.
- 4 Start a cycle from the LG SmartThinQ application on your smartphone.

## NOTE

- Once the Remote Start mode is enabled, you can start a cycle from the LG SmartThinQ smartphone application. If the cycle is not started, the machine will wait to start the cycle until it is turned off remotely from the application or the Remote Start mode is disabled.
- If the door is open, Remote Start is disabled.

#### To Disable Remote Start:

When Remote Start is activated, press and hold the **Buzzer** button for 3 seconds.

## Download Cycle

Download new and special cycles that are not included in the basic cycles on the appliance.

Appliances that have been successfully registered can download a variety of specialty cycles specific to the appliance.

Only one cycle can be stored on the appliance at a time.

Once cycle download is completed in the appliance, the product keeps the downloaded cycle until a new cycle is downloaded.

## Wireless LAN Module Specifications

<b>Model</b>	LCW-004
<b>Frequency Range</b>	2412 to 2472 MHz
<b>Output Power (Max)</b>	IEEE 802.11b:17.82 dBm IEEE 802.11g:17.72 dBm IEEE 802.11n:16.61 dBm

Wireless function S/W version : V 1.0

For consideration of the user, this device should be installed and operated with a minimum distance of 20 cm between the device and the body.

<b>Standby power consumption</b>	0.18 W
<b>Network standby power consumption</b>	2.0 W
<b>The period of time after which the power management function, or a similar function, switches the equipment automatically into standby and/or off mode and/or the condition providing networked standby</b>	20 min.

## Declaration of Conformity



Hereby, LG Electronics declares that the radio equipment type Dryer is in compliance with Directive 2014/53/EU. The full text of the EU declaration of conformity is available at the following internet address:

<http://www.lg.com/global/support/cedoc/cedoc#>  
LG Electronics European Shared Service Centre B.V.

Krijgsman 1  
1186 DM Amstelveen  
The Netherlands

## Open Source Software Notice Information

To obtain the source code under GPL, LGPL, MPL, and other open source licenses, that is contained in this product, please visit <http://opensource.lge.com>.

In addition to the source code, all referred license terms, warranty disclaimers and copyright notices are available for download.

LG Electronics will also provide open source code to you on CD-ROM for a charge covering the cost of performing such distribution (such as the cost of media, shipping, and handling) upon email request to [opensource@lge.com](mailto:opensource@lge.com). This offer is valid for a period of three years after our last shipment of this product. This offer is valid to anyone in receipt of this information.

## Smart Diagnosis™ Using a Smartphone

- For appliances with the  or  logo

Use this function if you need an accurate diagnosis by an LG Electronics customer information centre when the appliance malfunctions or fails.

Smart Diagnosis™ can not be activated unless the appliance is connected to power. If the appliance is unable to turn on, then troubleshooting must be done without using Smart Diagnosis™.



## Using Smart Diagnosis™

### Smart Diagnosis™ Through the Customer Information Centre

Use this function if you need an accurate diagnosis by an LG Electronics customer information centre when the appliance malfunctions or fails. Use this function only to contact the service representative, not during normal operation.

- 1 Press the **Power** button to turn on the appliance. Do not press any other buttons or turn the programme selector knob.
- 2 When instructed to do so by the call centre, place the mouthpiece of your phone close to the Smart Diagnosis™ icon.

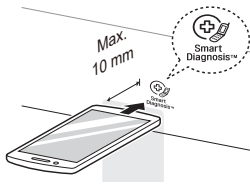

- 3 Press and hold the **More Time** button for three seconds, while holding the phone mouthpiece to the icon and **Power** button.
- 4 Keep the phone in place until the tone transmission has finished. Time remaining for data transfer is displayed.
  - For best results, do not move the phone while the tones are being transmitted.
  - If the call centre agent is not able to get an accurate recording of the data, you may be asked to try again.
- 5 Once the countdown is over and the tones have stopped, resume your conversation with the call centre agent, who will then be able to assist you using the information transmitted for analysis.

### NOTE

- The Smart Diagnosis™ function depends on the local call quality.
- The communication performance will improve and you can receive better service if you use the home phone.
- If the Smart Diagnosis™ data transfer is poor due to poor call quality, you may not receive the best Smart Diagnosis™ service.

## WARNING

- Remove the power plug when you clean the appliance. Not removing the plug may result in electric shock.

## Cleaning the Lint Filter

Clean the lint filter before each drying cycle.

Cleaning the lint filter will reduce drying time and energy consumption.

- 1 Open the door.
- 2 Remove the first lint filter.

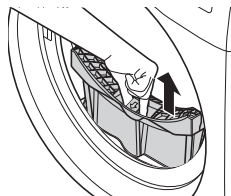

- 3 Remove the second lint filter.

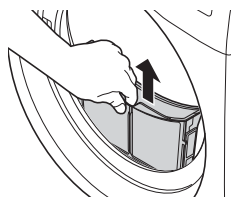

- 4 Open both lint filters and remove all the lint.
  - Open the first lint filter.

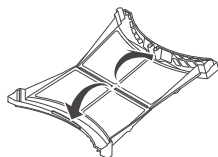

- Open the second lint filter.

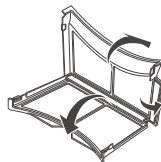

- 5 Rinse away the lint under warm, running water.

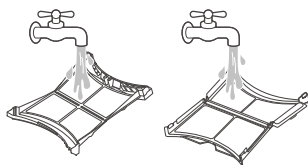

- 6 Dry the lint filters completely, close them and reinsert both lint filters.



## NOTE

- Remove moisture from the mesh. Otherwise, the lint filter may be clogged due to water film and the appliance may not operate.
- If the lint filter is not in the appliance, you can not operate the appliance.

## Emptying the Water Container

Condensed water is collected in the water container.

Empty the water container after every use. Not doing so will affect the drying performance.

If the water container is full, the  icon glows and the buzzer sounds while the appliance is operating. If this should occur, the water container needs to be emptied within the next hour.

- 1 Pull out the water container.

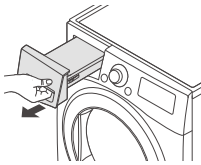

- 2 Empty the water container in the sink.

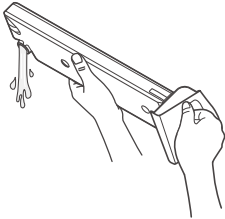

- 3 Push it back into the appliance.
- 4 Press the **Start/Pause** button.

## Cleaning the Cool Air Inlet Grill

Vacuum the Cool Air Inlet grill 3 - 4 times a year to make sure there is no build-up of lint or dirt that may cause improper air flow.

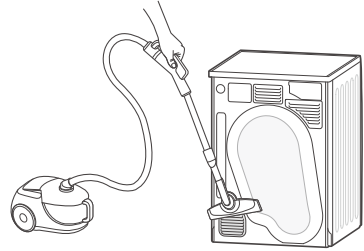

### NOTE

- Warm air is expelled through the ventilation grill.
- Adequate ventilation should be provided to avoid the back flow of gases into the room from units burning other fuels, such as open fires.

## Wiping the Moisture Sensor

This device senses the moisture level of the laundry during operation, which means it must be cleaned regularly to remove any build-up of lime scale on the surface of the sensor.

Wipe the sensors inside the drum.

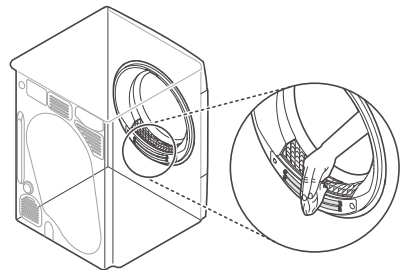

### CAUTION

- Do not wipe the moisture sensor with abrasive materials. Always clean the sensor with a rough sponge.

The appliance is equipped with an automatic error-monitoring system to detect and diagnose problems at an early stage. If the appliance does not function properly or does not function at all, check the following before you call for service:

## Diagnosing Problems

Symptoms	Reason	Solution
Appliance will not turn on.	Power cord is not properly plugged in.	<ul style="list-style-type: none"> <li>Make sure that the plug is securely plugged into a grounded outlet matching the appliance's rating plate.</li> </ul>
	House fuse is blown, circuit breaker has tripped, or power outage has occurred.	<ul style="list-style-type: none"> <li>Reset circuit breaker or replace fuse. Do not increase fuse capacity. If the problem is a circuit overload, have it corrected by a qualified electrician.</li> </ul>
Appliance does not heat.	House fuse is blown, circuit breaker has tripped, or power outage has occurred.	<ul style="list-style-type: none"> <li>Reset circuit breaker or replace fuse. Do not increase fuse capacity. If the problem is a circuit overload, have it corrected by a qualified electrician.</li> </ul>
Clothes take too long to dry.	Load is not properly sorted.	<ul style="list-style-type: none"> <li>Separate heavy items from lightweight items. Larger and heavier items take longer to dry. Light items in a load with heavy items can fool the sensor because the light items dry faster.</li> </ul>
	Large load of heavy fabrics.	<ul style="list-style-type: none"> <li>Heavy fabrics take longer to dry because they tend to retain more moisture. To help reduce and maintain more consistent drying times for large and heavy fabrics, separate these items into smaller loads of a consistent size.</li> </ul>
	Appliance controls are not set properly.	<ul style="list-style-type: none"> <li>Use the appropriate control settings for the type of load you are drying. Some loads may require an adjustment of the dry level setting for proper drying.</li> </ul>
	Lint filter needs to be cleaned.	<ul style="list-style-type: none"> <li>Remove the lint from the lint filter before every cycle. With the lint removed, hold the lint filter up to a light to see if it is dirty or clogged. With some loads that produce high amounts of lint, such as new bath towels, it may be necessary to pause the cycle and clean the filter during the cycle.</li> </ul>

Symptoms	Reason	Solution
Clothes take too long to dry.	<b>House fuse is blown, circuit breaker has tripped, or power outage has occurred.</b>	<ul style="list-style-type: none"> <li>Reset circuit breaker or replace fuse. Do not increase fuse capacity. If the problem is a circuit overload, have it corrected by a qualified electrician.</li> </ul>
	<b>Appliance is overloaded.</b>	<ul style="list-style-type: none"> <li>Divide extra large loads into smaller loads for better drying performance and efficiency.</li> </ul>
	<b>Appliance is underloaded.</b>	<ul style="list-style-type: none"> <li>If you are drying a very small load, add a few extra items to ensure proper tumbling action. If the load is very small and you are using Sensor Dry programmes, the electronic control cannot properly sense the dryness of the load and may shut off too soon. Use Timed Drying programmes or add some extra wet clothes to the load.</li> </ul>
Drying time is not consistent.	<b>Heat settings, load size, or dampness of clothing is not consistent.</b>	<ul style="list-style-type: none"> <li>The drying time for a load will vary depending on the type of heat used (electric), the size of the load, the type of fabrics, the wetness of the clothes, and lint filter. Even an unbalanced load in the appliance can cause poor spinning, resulting in wetter clothes which will take longer to dry.</li> </ul>
Greasy or dirty spots are left on clothes.	<b>Fabric softener is used incorrectly.</b>	<ul style="list-style-type: none"> <li>When washing laundry that is to be dried in the appliance, use the correct amount of fabric softener as recommended by the manufacturer of the fabric softener.</li> </ul>
	<b>Clean and dirty clothes are being dried together.</b>	<ul style="list-style-type: none"> <li>Use the appliance to dry only clean items. Soil from dirty clothes can transfer to the clean clothes in the same or later loads.</li> </ul>
	<b>Clothes were not properly cleaned or rinsed before being placed in the appliance.</b>	<ul style="list-style-type: none"> <li>Stains on dried clothes could be stains that were not removed during the washing process. Make sure that clothes are being completely cleaned or rinsed according to the instructions for your washing machine and detergent. Some difficult soils may require pre-treating prior to washing.</li> </ul>

Symptoms	Reason	Solution
Clothes are wrinkled.	Clothes have dried too long (overdried).	<ul style="list-style-type: none"> <li>Over drying a load of laundry can lead to wrinkled clothes. Try a shorter drying time.</li> </ul>
	Clothes have been left in the appliance for too long after cycle ends.	<ul style="list-style-type: none"> <li>Use the Anti crease option.</li> </ul>
Clothes are shrinking.	Garment care instructions are not being followed.	<ul style="list-style-type: none"> <li>To avoid shrinking your clothes, always consult and follow fabric care instructions. Some fabrics will naturally shrink when washed. Other fabrics can be washed but will shrink when dried in the appliance. Use a low or no heat setting.</li> </ul>
Lint is left on clothes.	Lint filter has not been cleaned properly.	<ul style="list-style-type: none"> <li>Remove the lint from the lint filter before every cycle. With the lint removed, hold the lint filter up to a light to see if it is dirty or clogged. If it looks dirty, follow the cleaning instructions. With some loads that produce high amounts of lint, it may be necessary to clean the lint filter during the cycle.</li> </ul>
	Laundry has not been sorted properly.	<ul style="list-style-type: none"> <li>Some fabrics are lint producers (i.e., a fuzzy white cotton towel) and should be dried separately from clothes that are lint trappers (i.e., a pair of black linen pants).</li> </ul>
	Appliance is overloaded.	<ul style="list-style-type: none"> <li>Divide extra large loads into smaller loads for drying.</li> </ul>
	Tissue, paper, etc., has been left in pockets.	<ul style="list-style-type: none"> <li>Check pockets thoroughly before drying clothes.</li> </ul>
Excess static in clothes after drying.	Clothes have dried for too long (overdried).	<ul style="list-style-type: none"> <li>Overdrying a load of laundry can cause a buildup of static electricity. Adjust settings and use a shorter drying time, or use Sensor Dry programmes.</li> </ul>
	Drying synthetics, non-iron, or synthetic blends.	<ul style="list-style-type: none"> <li>These fabrics are naturally more prone to static buildup. Try using fabric softener, or use shorter Timed Drying time settings.</li> </ul>

Symptoms	Reason	Solution
<b>Water leaks.</b>	<b>The water container hose or the drain hose is not connected correctly.</b>	<ul style="list-style-type: none"> <li>Connect the water container hose or the drain hose correctly.</li> </ul>
	<b>The door is closed while laundry or foreign substance is caught in the door.</b>	<ul style="list-style-type: none"> <li>Check if laundry or foreign substance is caught in the door before using the appliance. If water leaks continuously, contact the LG Electronics Customer Information Centre.</li> </ul>
<b>Clothes have damp spots after a Sensor Dry programme.</b>	<b>Very large load or very small load. Single large item such as a blanket or comforter.</b>	<ul style="list-style-type: none"> <li>If items are too tightly packed or too sparse the sensor may have trouble reading the dryness level of the load. Use a Timed Drying programme for very small loads.</li> <li>Large, bulky items such as blankets or comforters can sometimes wrap themselves into a tight ball of fabric. The outside layers will dry and register on the sensors, while the inner core remains damp. When drying a single bulky item, it may help to pause the cycle once or twice and rearrange the item to unwrap and expose any damp areas.</li> <li>To dry a few remaining damp items from a very large load or a few damp spots on a large item after a Sensor Dry programme has completed, empty the lint trap, then set a Timed Drying programme to finish drying the item(s).</li> </ul>
<b>Your home appliance and smartphone is not connected to the Wi-Fi network.</b>	<b>The password for the Wi-Fi that you are trying to connect to is incorrect.</b>	<ul style="list-style-type: none"> <li>Find the Wi-Fi network connected to your smartphone and remove it, then register your appliance on LG SmartThinQ.</li> </ul>
	<b>Mobile data for your smartphone is turned on.</b>	<ul style="list-style-type: none"> <li>Turn off the <b>Mobile data</b> of your smartphone and register the appliance using the Wi-Fi network.</li> </ul>
	<b>The wireless network name (SSID) is set incorrectly.</b>	<ul style="list-style-type: none"> <li>The wireless network name (SSID) should be a combination of English letters and numbers. (Do not use special characters.)</li> </ul>
	<b>The router frequency is not 2.4 GHz.</b>	<ul style="list-style-type: none"> <li>Only a 2.4 GHz router frequency is supported. Set the wireless router to 2.4 GHz and connect the appliance to the wireless router. To check the router frequency, check with your Internet service provider or the router manufacturer.</li> </ul>
	<b>The distance between the appliance and the router is too far.</b>	<ul style="list-style-type: none"> <li>If the distance between the appliance and the router is too far, the signal may be weak and the connection may not be configured correctly. Move the location of the router so that it is closer to the appliance.</li> </ul>

## Error Codes



Symptoms	Reason	Solution
dE	The door has been opened while the appliance is in operation or the appliance is being operated without the door being closed properly.	<ul style="list-style-type: none"> <li>• Close the door completely.</li> <li>• If dE is not released, call for service.</li> </ul>
dE4	Door switch detection is not working properly.	<ul style="list-style-type: none"> <li>• Unplug the power plug and call for service.</li> </ul>
tE1	Temperature Sensor has malfunctioned.	<ul style="list-style-type: none"> <li>• Unplug the power plug and call for service.</li> </ul>
tE2		
tE4		
F1	The temperature inside the drum has risen suddenly.	<ul style="list-style-type: none"> <li>• Unplug the power plug and call for service.</li> </ul>
LE1	The motor has stopped suddenly.	<ul style="list-style-type: none"> <li>• Check if the amount of laundry exceeds the maximum load.</li> <li>• Unplug the power plug and call for service.</li> </ul>
LE2	The compressor has stopped suddenly.	<ul style="list-style-type: none"> <li>• Unplug the power plug and call for service.</li> </ul>
AE		
OE	The drain pump motor has malfunctioned.	<ul style="list-style-type: none"> <li>• Unplug the power plug and call for service.</li> </ul>
	The surrounding temperature for installation is below zero.	<ul style="list-style-type: none"> <li>• The recommended surrounding temperature for installation is 5 - 35 °C.</li> </ul>



**THIS LIMITED WARRANTY DOES NOT COVER:**

- Service trips to deliver, pick up, or install or repair the product; instruction to the customer on operation of the product; repair or replacement of fuses or correction of wiring or plumbing, or correction of unauthorized repairs/installation.
- Failure of the product to perform during power failures and interruptions or inadequate electrical service.
- Damage caused by leaky or broken water pipes, frozen water pipes, restricted drain lines, inadequate or interrupted water supply or inadequate supply of air.
- Damage resulting from operating the Product in a corrosive atmosphere or contrary to the instructions outlined in the Product's owner's manual.
- Damage to the Product caused by accidents, pests and vermin, lightning, wind, fire, floods, or acts of God.
- Damage or failure caused by unauthorized modification or alteration, or if it is used for other than the intended purpose, or any water leakage where the product was not properly installed.
- Damage or failure caused by incorrect electrical current, voltage, or plumbing codes, commercial or industrial use, or use of accessories, components, or consumable cleaning products that are not approved by LG.
- Damage caused by transportation and handling, including scratches, dents, chips, and/or other damage to the finish of your product, unless such damage results from defects in materials or workmanship.
- Damage or missing items to any display, open box, discounted, or refurbished Product.
- Products with original serial numbers that have been removed, altered, or cannot be readily determined. Model and Serial numbers, along with original retail sales receipt, are required for warranty validation.
- Increases in utility costs and additional utility expenses.
- Repairs when your Product is used in other than normal and usual household use or contrary to the instructions outlined in the Product's owner's manual.
- Costs associated with removal of your Product from your home for repairs.
- The removal and reinstallation of the Product if it is installed in an inaccessible location or is not installed in accordance with published installation instructions, including LG's owner's and installation manuals.
- Damage resulting from misuse, abuse, improper installation, repair, or maintenance. Improper repair includes use of parts not approved or specified by LG.
- Noise or vibration that is considered normal, for example, water drain sound, spin sound or warning beeps.

<p>Filter is clogged. - Not heating, long dry time</p>		<p>Clean the lint filter.</p>
<p>Improperly connected power cord or electrical outlet issue. - No power - Not heating</p>		<p>Reconnect power cord, replace house fuse or reset breaker. If outlet is issue, electrician may be required.</p>

Product fiche_commission Delegated Regulation(EU) No 392/2012	
Supplier's name or trade mark	LG Electronics
Supplier's model identifier	FDJ608W
Rated capacity in kg of cotton laundry for the standard cotton programme at full load	8 kg
Dryer type	Condenser Household Tumble Dryer
Energy efficiency class	A+++
Energy consumption "X" kWh per year, based on 160 drying cycles of the standard cotton programme at full and partial load, and the consumption of the low-power modes. Actual energy consumption per cycle will depend on how the appliance is used	176 kWh/year
Automatic tumble drier	Yes
Awarded an "EU Ecolabel" under Regulation (EC) No 66/2010	No
Energy consumption of the standard cotton programme at full load ( $E_{dry}$ )	1.47 kWh
Energy consumption of the standard cotton programme at partial load ( $E_{dry1/2}$ )	0.80 kWh
Power consumption of the off-mode for the standard cotton programme at full load ( $P_o$ )	0.18 W
Power consumption of the left-on mode for the standard cotton programme at full load ( $P_l$ )	0.18 W
Duration of the left-on mode ( $T_l$ )	10 min
The ' Cotton  +  +  ' used at full and partial load is the standard drying programme to which the information in the label and the fiche relates, that this programme is suitable for drying normal wet cotton laundry and that it is the most efficient programme in terms of energy consumption for cotton.	
The weighted programme time ( $T_w$ ) of the 'standard cotton programme at full and partial load'	150 min
The programme time of the 'standard cotton programme at full load' ( $T_{dry}$ )	196 min
The programme time of the 'standard cotton programme at partial load' ( $T_{dry1/2}$ )	115 min
Condensation efficiency class 'X' on a scale from G (least efficient) to A (most efficient)	A
Average condensation efficiency $C_{dry}$ of the standard cotton programme at full load	91 %
Average condensation efficiency $C_{dry1/2}$ of the standard cotton programme at partial load	91 %
The weighted condensation efficiency ( $C_w$ ) for the 'standard cotton programme at full and partial load'	91 %
The sound power level	64 dB(A)
Free Standing	

# Memo

