

PIRANHA

BICYCLE OWNER'S MANUAL

IMPORTANT:

This manual contains important safety, performance and service information. Read it before you take the first ride on your new bicycle, and keep it for reference.

Additional safety, performance and service information for specific components such as suspension or pedals on your bicycle, or for accessories such as helmets or lights that you purchase, may also be available. Make sure that your dealer has given you all the manufacturers' literature that was included with your bicycle or accessories. In case of a conflict between the instructions in this manual and information provided by a component manufacturer, always follow the component manufacturer's instructions.

If you have any questions or do not understand something, take responsibility for your safety and consult with your dealer or the bicycle's manufacturer.

NOTE: This manual is not intended as a comprehensive use, service, repair or maintenance manual. Please see your dealer for all service, repairs or maintenance. Your dealer may also be able to refer you to classes, clinics or books on bicycle use, service, repair or maintenance.



GENERAL WARNING

Like any sport, cycling involves risk of injury and damage. By choosing to ride a bicycle, you assume the responsibility for that risk, so you need to know — and to practice — the rules of safe and responsible riding and of proper use and maintenance. Proper use and maintenance of your bicycle reduces risk of injury.

This Manual contains many warnings and cautions concerning the consequences of failure to maintain or inspect your bicycle and of failure to follow safe cycling practices.

Many of the Warnings and Cautions say “you may lose control and fall”.

Because any fall can result in serious injury or even death, we do not always repeat the warning of possible injury or death.

Because it is impossible to anticipate every situation or condition which can occur while riding, this Manual makes no representation about the safe use of the bicycle under all conditions. There are risks associated with the use of any bicycle which cannot be predicted or avoided, and which are the sole responsibility of the rider.

CONTENTS

1. First 4

2. Safety 5

3. Tech 6

3A. Saddle	6
3B. Stem	7
3C. Mudguards	9
3D. Wheels	10
3E. Basket	15
3F. Stabilisers	16
3G. Pedals	17
3H. Brakes	18
3I. Gears	22
3J. Rotor / Giro	26

4. Maintenance 28

5. Torque Specifications 33

6. Warranty 35

1. FIRST

We strongly urge you to read this Manual in its entirety before your child's first ride. At the very least, read and make sure that you understand each point in this section, and refer to the cited sections on any issue which you don't completely understand.

1. Ensure you have assembled the bike and fitted all loose parts that came in the box.
2. Check the chain is lubricated.
3. Make sure all wheel fixings are tight and fitted correctly.
4. Check trueness of wheels and tyre pressures.
5. Make sure your saddle is at the correct riding height and position and not beyond the minimum insertion mark. Check that all fixings are tight
6. Make sure you have adjusted the handlebar height and angle to your riding position (where applicable) and that it is not beyond the minimum insertion mark. Check all nuts are tight.
7. Any extras or accessories must be correctly fitted and tight.
8. If your bike is a BMX with a 360 Giro, check that the handlebar can be fully rotated without cables snagging.
9. Check brake functionality. Adjust if necessary. Right hand lever should operate front brake and left should operate rear. Make sure you can reach and operate the brakes comfortably from your riding position.
10. Make sure your gears change cleanly and that you can operate the gear levers comfortably from your riding position.
11. Check chainwheel and crank bolt are tight

2. SAFETY

Make sure your child's first ride is in a quiet area away from cars, other cyclists, obstacles etc. Make sure your child becomes familiar with all the controls and features of their new bike, especially brake performance.

If you feel anything about the bike is not as it should be consult a qualified bicycle mechanic.

Always wear a helmet! Safety gear is also available for knees, elbows, back, shoulders and more. It is highly recommended. Protective eyewear is also recommended.

You should make sure your child wears appropriate clothing that is bright and visible and not too loose. Loose clothing can catch in moving parts and cause them to lose control and fall. Be sure they dress in accordance to the weather. Footwear should be able to grip the pedals and not have loose laces.

Make sure you / your child know all the local traffic laws and obey them. Bicycles are sharing the road with others and should always assume they haven't been seen and exercise maximum caution, especially on busy roads and around large vehicles.

If your child is going to ride off-road, conditions may require extra attention and specific skills. Make sure they get to know their bike well before trying increased speed or difficult terrain.

Be aware that in wet conditions, the bike's brakes stopping power (and those of other road users) is greatly reduced.

If the bike is going to be ridden at night, make sure you obey all laws regarding lighting and clothing and be aware that cyclists are often hard to spot for drivers and pedestrians alike.

Any form of jump, stunt, race or other extreme riding will invalidate your warranty.

HELMETS SAVE LIVES!

Always wear a cycling helmet which meets the latest certification standards and is appropriate for the type of riding you do. Always follow the helmet manufacturer's instructions for fit, use and care of your helmet. Most serious bicycle injuries involve head injuries which might have been avoided if the rider had worn an appropriate helmet.

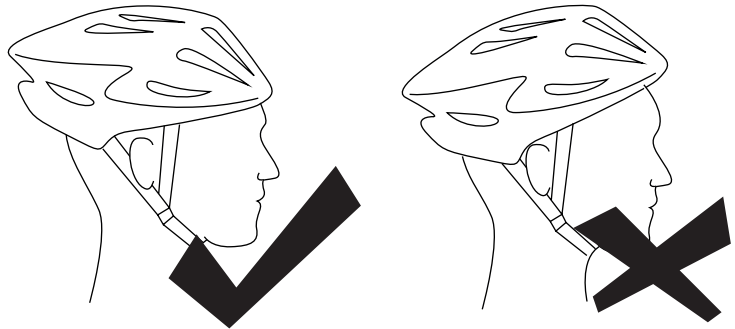

3. TECH

3A SADDLE INSTALLATION & ADJUSTMENT

SADDLE HEIGHT

Saddle height is very important in order to make your child's cycling experience more enjoyable and of course safer. The correct saddle height should not cause their knee to lock out with their foot on the pedal in the downward most position, however their knee should only be slightly bent.

- i* To insert saddle or to adjust saddle height, you need to release the seat clamp by turning anti-clockwise. This will require a spanner which was provided in the box with the bike.
- ii* Once the seat clamp is released, the seat post will become loose and you will be able to move the saddle up and down.
- iii* Once your saddle is at the desired height, tighten up the seat clamp again by turning clockwise as shown.

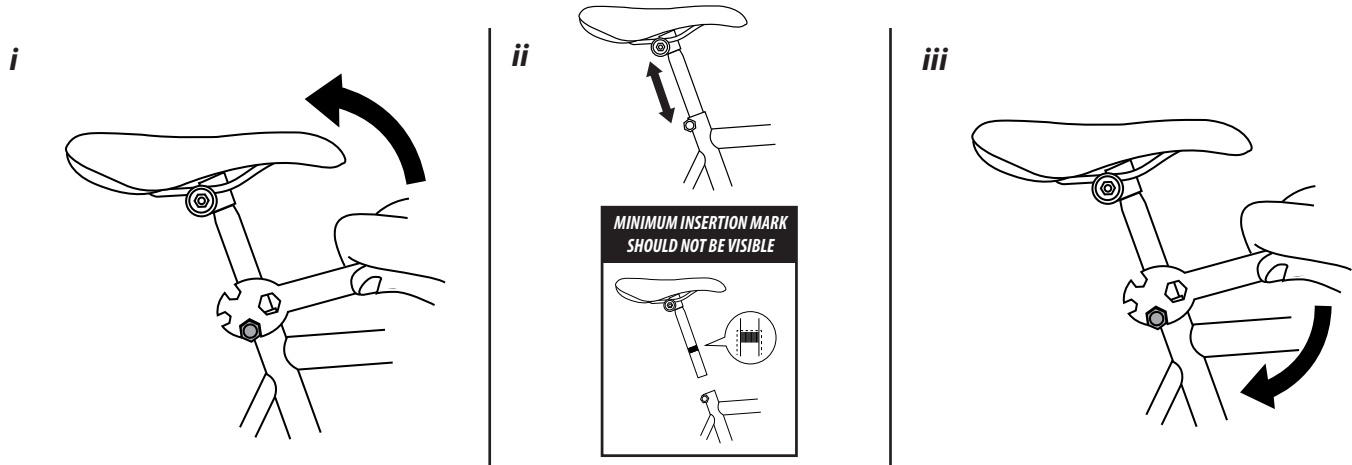

When adjusting the saddle, always be aware of the minimum insertion mark and always make sure this is not visible above the frame, or you risk damaging the bicycle or losing control causing serious injury or worse.

SADDLE FORE AND AFT ADJUSTMENT

Some saddles can also be moved backwards and forwards. For optimal riding position your child should be able to comfortably reach the handlebars and use the breaks and gears (if applicable) whilst riding with their arms slightly bent at the elbows.

- i.* To adjust saddle just unfasten the nut under the saddle using either a spanner or an allen key and turning anti-clockwise.
- ii.* You can then adjust saddle backwards and forwards, ensuring that only the flat part of the saddle rail is in the clamp.
- iii.* Tighten the nut under the saddle back up by turning clockwise

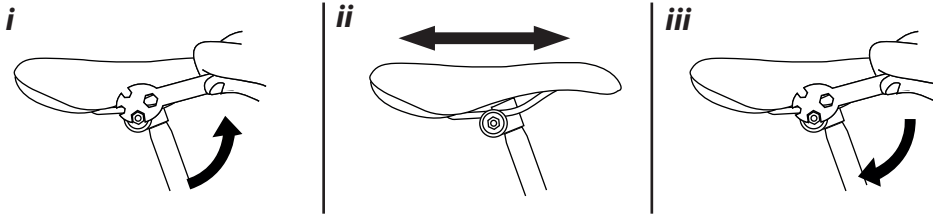

3B STEM INSTALLATION & ADJUSTMENT

Make sure that when you install the stem / handlebar you don't twist the cables.

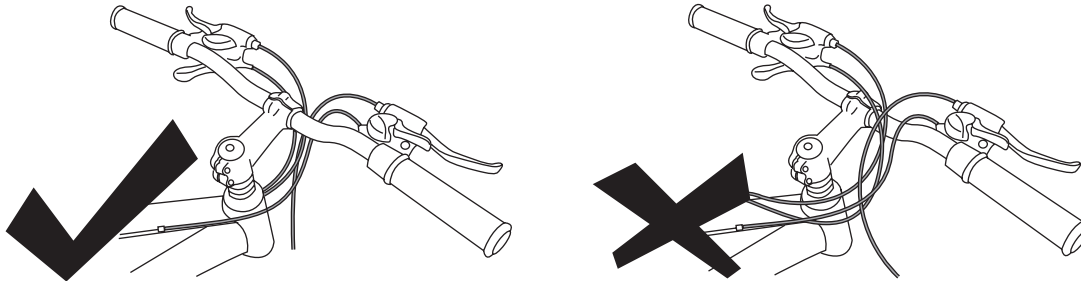

- i* To adjust or install stem, you need to loosen the centre bolt enough so that the stem will fit / become loose in the steerer tube, by turning it anti-clockwise with allen key provided.
- ii* You can then insert or adjust the stem. You can rotate it left to right and you can also adjust the height. **It is very important that you observe the minimum insertion mark and that you insert the stem beyond this. This must not be visible once the stem is installed.**
- iii* Once your stem is in place and in line with the forks, tighten it up by turning the centre bolt clockwise (it may be easier to re-adjust this with the front wheel fitted, so the stem is in line with it).

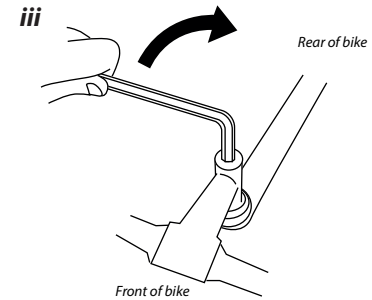
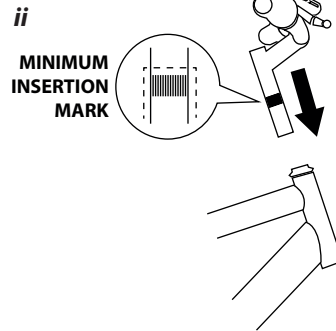
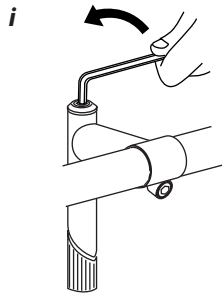

Handlebar rotation

If you need to adjust the angle of your handlebar, you can do this by loosening the clamping nut. The handlebar will then rotate freely in the stem. Adjust to desired angle, and ensuring the bar is still centred in the stem, tighten the clamping bolt.

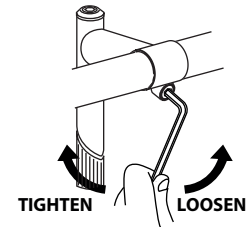



WARNING

You **MUST** make sure the stem & handlebar is inserted beyond the minimum insertion mark. If you don't you may damage the bike or the stem. You may also lose control and fall, which could cause you serious injury. Once you have finished assembling you should test the stem by holding the front wheel between your leg and trying to turn the handlebars. If these turn without turning the front wheel you need to line the handlebar back up and re-tighten.

3C MUDGUARD INSTALLATION

Your bike may have come equipped with mudguards. The front mudguard will usually come separate in the box and will need fitting.

- i* First, remove the nut from the bolt in the top of the fork using the spanner provided, leave the bolt in place through the fork. Then remove the two screws from the feet of the fork using a crosshead screwdriver.
- ii* You can then locate the mudguard in place. First feed the mudguard through the back of the fork as shown. Locate the mudguard on the bolt you left in the fork as and screw the nut on clockwise until it is finger tight. You can then screw the mudguard to the feet of the fork by replacing screws through the mudguard brackets and into the fork, tightening them by turning clockwise with a crosshead screwdriver. Tighten the nut on the top of the fork turning clockwise using the spanner provided.

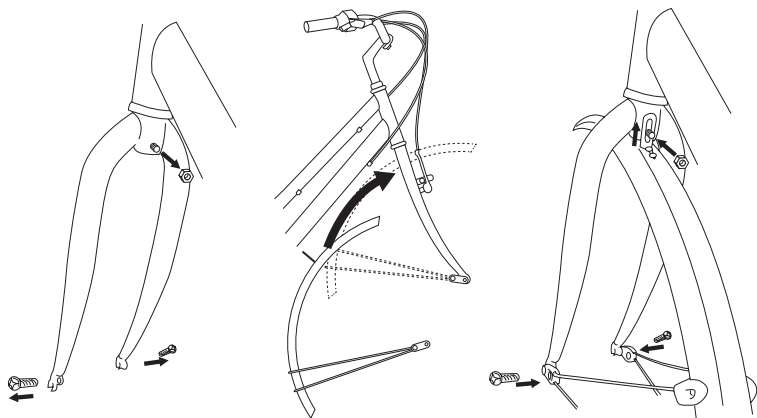

3D WHEEL INSTALLATION & ADJUSTMENT

The wheel axles are inserted into slots, called “dropouts” in the fork and frame. Examples below

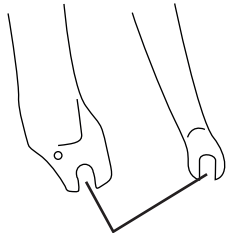

FORK DROPOUT

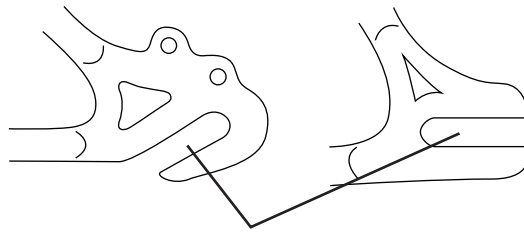

REAR DROPOUT

Dropouts come in way too many different shapes and sizes to be able to illustrate them all here, but these examples should guide you to indentifying where your dropouts are.

NUTTED WHEEL SYSTEM

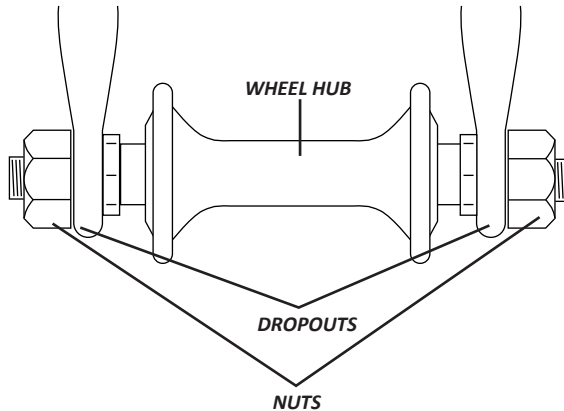

How does it work?

The wheel hub is clamped in place by the force of the nuts against the dropouts. The amount of clamping force is controlled by the tightness of the nuts. Turning the trnuts clockwise increases clamping force; turning them counterclockwise reduces clamping force. Both nuts need tightening to correct torque, available at the rear of this manual

Installing and adjusting a front wheel with a nutted system

If your bike comes with a nutted front wheel, the nuts will usually come already on the front wheel.

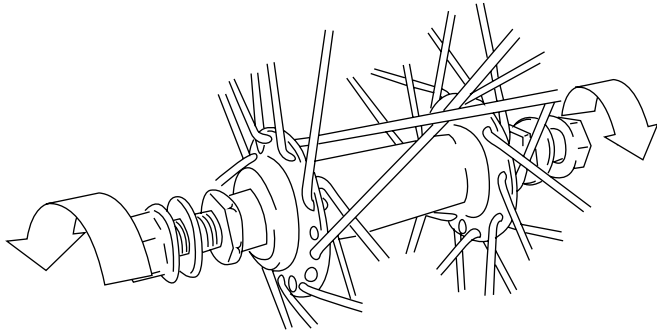

- i* Make sure the wheel nuts are loosened by turning anticlockwise, exposing as much of the thread as possible.

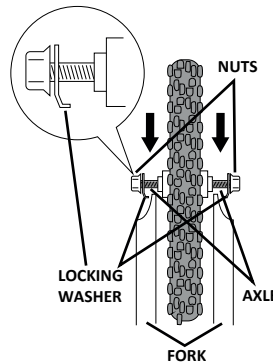
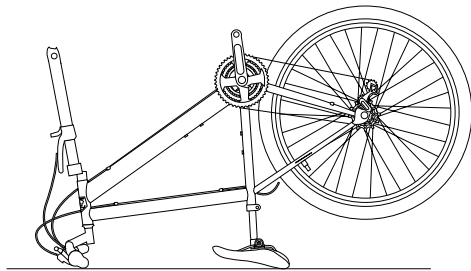

- ii* For this step, as long as your saddle and handlebar are installed, it helps to turn the bike upside down. You should then insert the wheel into the dropouts as shown, ensuring that the locking washers are on the outside of the fork as shown. You may need to release the brakes to get the wheel through. If this is the case, go the brakes section of this manual where you will find instructions on how to do this.

IF YOU HAVE A TRADITIONAL BASKET

If your bike comes with a traditional basket the bracket for this needs to be installed before we can secure the wheel in place. You will need to remove the nuts completely from the front wheel before sitting the wheel in the front dropouts.

- a With the wheel sat in the fork, insert the locking washers on to the axles, securing the pin in place as shown.
- b Then insert the basket bracket, with the flat part facing towards the bike frame as shown.
- c Finally, screw the nut on clockwise. You should only screw this on finger tight for the time being, we will tighten it once the basket is installed.

a



b

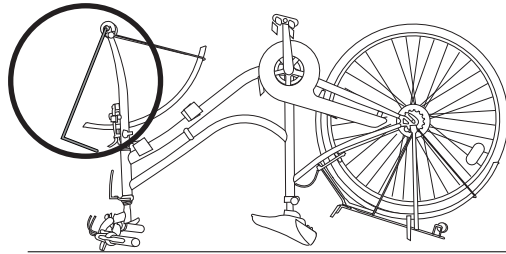
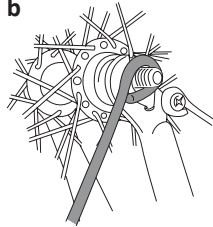

c

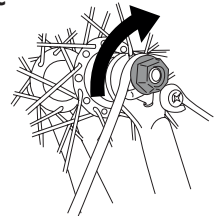

THE PIN ON THE LOCKING WASHER MUST BE PLACED IN THE HOLE.

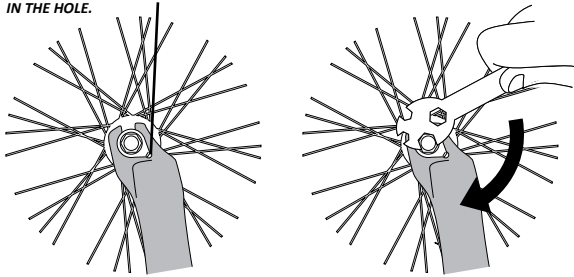

- iii** Place the pointed side of the locking washer into the hole in the fork as shown, then ensuring the gap between the wheel and the fork is equal on both sides, tighten the nut by turning clockwise using a spanner. Recommended torques can be found at the back of this catalogue



WARNING

If you disengaged your brake to get the wheel in, it is very important that you now re-engage it. Visit the brakes section of this manual for instructions on how to do this.

Should you need to remove your wheel to replace it or to repair it, simply reverse these steps.

Removing or adjusting a rear wheel with a nutted system

This step is easier with the bike upside down, resting on the saddle and the handlebars. For that purpose, the images here show what these steps look like with the bike upside down.

- i** Should your bike have gears, shift the rear derailleur to high gear (the smallest, outermost rear sprocket).
- ii** You then may need to release the brakes to get enough clearance for the wheel to pass through. Should this be the case, see the brakes section in this manual for instructions on how to do this.

- iii** Loosen the nuts on the wheel, then push the wheel forward far enough to be able to remove the chain from the rear sprocket.
- iv** Should your bike have gears, pull the derailleur body back with your right hand to release the tension on the chain and hold it there for the next step.
- v** You can now remove the wheel out of the dropouts.

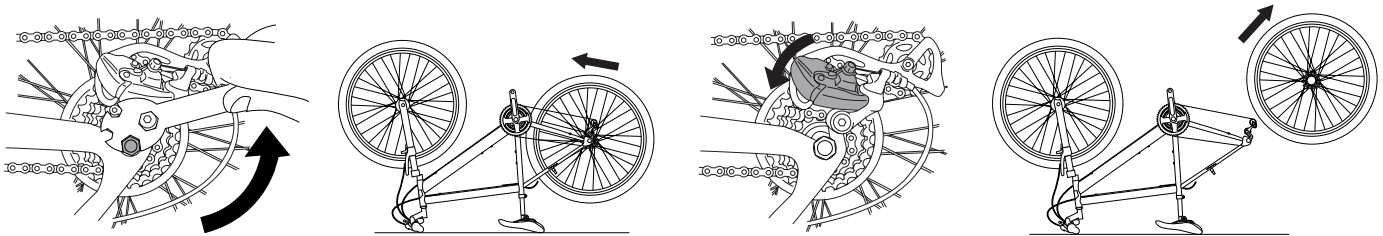

When you come to replace your wheel, simply reverse these steps.



WARNING

If you disengaged your brake to get the wheel in, it is very important that you now re-engage it. Visit the brakes section of this manual for instructions on how to do this.

3E. BASKET INSTALLATION

If your bike is either a heritage or trekking style bike, it may have come with a basket. There are two main types of basket, traditional and quick release.

Traditional basket

If you have a traditional wicker or faux wicker basket, first you will need to fit the basket bracket on the wheel axle. This explained in the wheel section of this manual. If your wheel is already installed, you may need to loosen the nuts to get the bracket in place. Once you have done this, follow these steps to install the basket.

- i* Make sure the stem basket bracket is facing the front and that the fork basket bracket is above the wheel in the horizontal position as shown. Sit the basket on the fork basket with the fixing plate towards the stem bracket, making sure the cables don't get in the way.

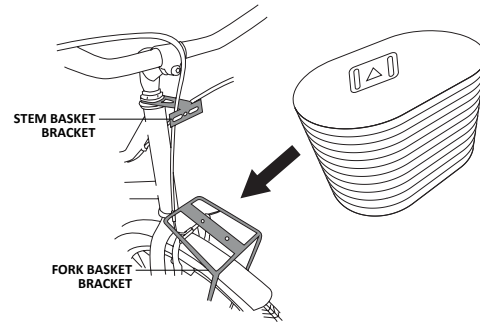

TOP VIEW

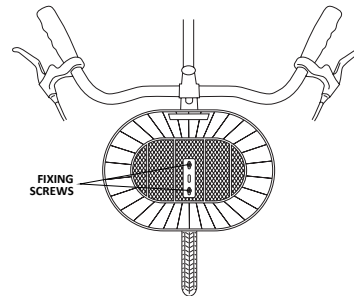

BOTTOMVIEW

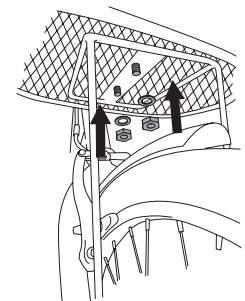

- ii* Line the base plate on the bracket up with the holes on the basket bracket, and drop 2 fixing screws with washers in the holes as shown. Place two washers and screw on the two nuts from underneath as shown, turning clockwise until finger tight.

- iii* Line the holes in the basket plate and the frame bracket up and insert the screws / washers / fixing plate as shown. Then from behind the frame bracket, place the washers on the screws and screw the nuts on clockwise finger tight.

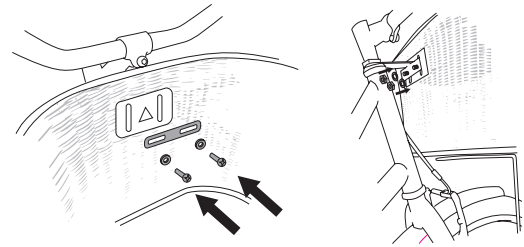

3F. STABILISERS

- i* Remove the outer nut and washer from each side of the back wheel by turning anti-clockwise using the spanner provided
- ii* Place the bracket over the thread ensuring the tabs lock in the dropout, followed by the stabiliser, the washer and the nut. Tighten the nut by turning clockwise until it is finger tight. Repeat for the other side.
- iii* Once both stabilisers are finger tight, ensure they are both around 5mm from the ground with the bike vertical. This is to ensure that if the bike goes over uneven ground the rear wheel won't be lifted of the ground causing it to lose traction.
- iv* Tighten both nuts by turning clockwise using the spanner provided

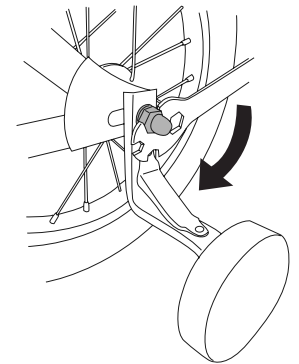
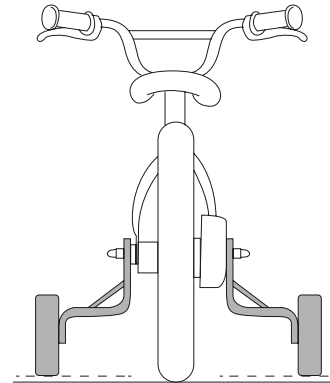
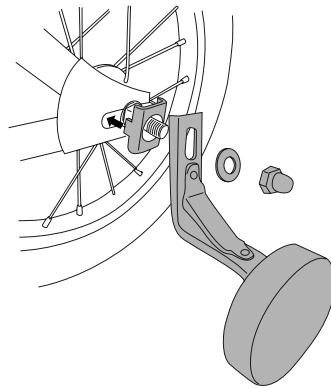
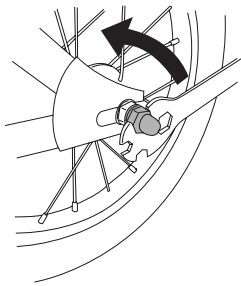

3G. PEDALS

Pedals are marked whether they fit in the left or the right. It is very important to insert the correct pedal into the correct crank arm, as if you don't you could cross thread them and cause irreparable damage not covered by warranty.

- i* Stickers indicate the left and right pedal. If these have dropped off, look at the end of the thread where it is imprinted.
- ii* The correct pedal needs to be attached to the matching side of the bike i.e. left pedal to left side and right pedal to right side.
- iii* **IMPORTANT!** Pedals need screwing in opposite directions so they don't fall off in use. Left pedal is screwed in anti-clockwise / Right pedal is screwed in clockwise. Tighten pedals with spanner provided.

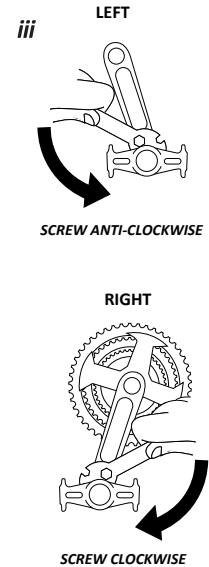
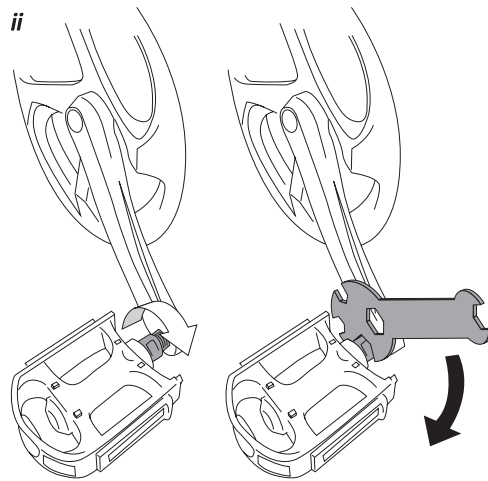
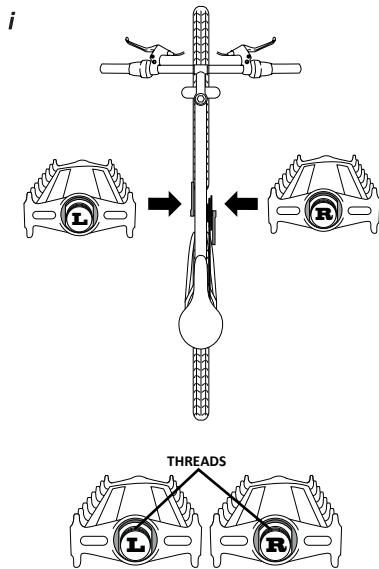

3H. BRAKES

It's very important for your child's safety that they learn and remember which brake lever controls which brake on your bike. Traditionally, the left brake lever controls the rear brake and the right brake lever controls the front brake; but, to make sure your child's bike's brakes are set up this way, squeeze one brake lever and look to see which brake, front or rear, engages. Now do the same with the other brake lever.

Make sure that their hands can reach and squeeze the brake levers comfortably. If their hands are too small to operate the levers comfortably, consult your local bike shop before riding the bike. The lever reach may be adjustable; or you may need a different brake lever design.

How brakes work

The braking action of a bicycle is a function of the friction between the braking surfaces. To make sure that you have maximum friction available, keep your wheel rims and brake pads free of dirt, lubricants, waxes or polishes.

Brakes are designed to control your speed, not just to stop the bike. Maximum braking force for each wheel occurs at the point just before the wheel "locks up" (stops rotating) and starts to skid. Once the tyre skids, you actually lose most of your stopping force and all directional control. You need to practice slowing and stopping smoothly without locking up a wheel.

The technique is called progressive brake modulation. Instead of jerking the brake lever to the position where you think you'll generate the appropriate braking force, squeeze the lever, progressively increasing the braking force.

If you feel the wheel begin to lock up, release pressure just a little to keep the wheel rotating just short of lockup. It's important to develop a feel for the amount of brake lever pressure required for each wheel at different speeds and on different surfaces. To better understand this, experiment a little by walking your bike and applying different amounts of pressure to each brake lever, until the wheel locks.

When you apply one or both brakes, the bike begins to slow, but your body wants to continue at the speed at which it was going. This causes a transfer of weight to the front wheel (or, under heavy braking, around the front wheel hub, which could send you flying over the handlebars). A wheel with more weight on it will accept greater brake pressure before lockup; a wheel with less weight will lock up with less brake pressure. So, as you apply brakes and your weight is transferred forward, you need to shift your body toward the rear of the bike, to transfer weight back on to the rear wheel; and at the same time, you need to both decrease rear braking and increase front braking force. This is even more important on descents, because descents shift weight forward.

Two keys to effective speed control and safe stopping are controlling wheel lockup and weight transfer. This weight transfer is even more pronounced if your bike has a front suspension fork. Front suspension "dips" under braking, increasing the weight transfer. Practice braking and weight transfer techniques where there is no traffic or other hazards and distractions.

Everything changes when you ride on loose surfaces or in wet weather. It will take longer to stop on loose surfaces or in wet weather. Tire adhesion is reduced, so the wheels have less cornering and braking traction and can lock up with less brake force. Moisture or dirt on the brake pads reduces their ability to grip. The way to maintain control on loose or wet surfaces is to go more slowly.

RIM BRAKES

Rim brakes work by squeezing brake pads (usually made out of rubber) against the rim in order to slow the wheel down. Brakes are a very important part of the bike, and you need to familiarize yourself with which type of brake you have. It is important that you keep these serviced. You may need to adjust the brakes, and you may need to release and engage them in order to replace a wheel. In this manual you will find a guide on how to do these. However **if you are unsure about anything to do with your brakes or their functions, you should consult a qualified bicycle mechanic before riding your bike.**

You should regularly check these points and adjust accordingly (these rules do not apply for disc brakes). If you are unsure, consult a qualified bicycle mechanic:

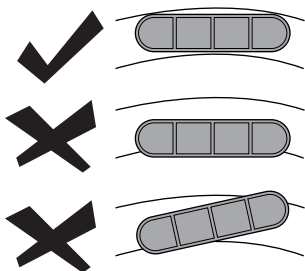

Check the brake pads are square to the rim

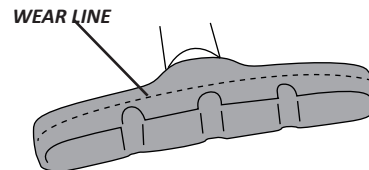
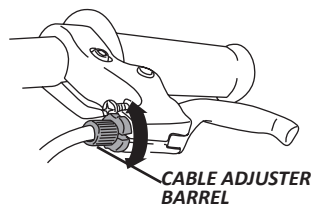
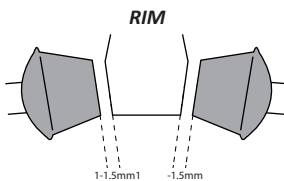

The brake pads should not be worn beyond the wear line

Both brake pads should be parallel and equal distance from the rim (1-1.5mm). As brake pads begin to wear you can fine tune the distance from the pad to the rim by turning the cable adjuster screw on the brake lever. Your brake arms may also have an adjuster on them, see this section to determine which type of brakes your bike has.

Also...

Both brake arms should move the same distance when you squeeze the brake lever

The rim should run freely through the brake pads with no contact when the brake is open

The brake pads should touch the rim before the brake lever is 1/3 of the way to the handlebar.

V BRAKES

To release your V brakes in order to fit or replace your wheel, pull back the black rubber protector and squeeze the two brake arms together. Whilst holding these you can pull the brake out by the noodle as shown.

To re-engage your brakes once wheel is fitted, you need to squeeze the brake arms together again and reverse step *ii*.

i

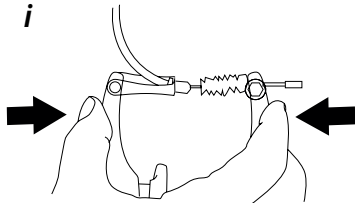

ii

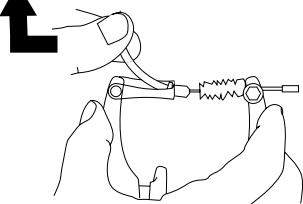

CABLE GUIDE PIPE (NOODLE)

Hooks into the left hand arm and connects the two brake arms so that they both move towards the wheel when the brake lever is pulled

BRAKE PAD ADJUSTMENT BOLT

This bolt secures the brake pad to the brake arm and can be released to adjust the angle of the brake pad.

SPRING TENSION SCREW

Adjusts spring strength for each brake arm. Turn clockwise to increase tension and anti-clockwise to decrease.

BRAKE CABLE

Operates the brake arms when the brake lever on the handlebars is pulled

CABLE PINCH BOLT

This bolt secures the brake cable to the brakes. You can release this bolt to adjust the distance from the brake arm to the wheel

BRAKE ARMS

Move inwards to press the brake pads against the rim of the wheel

BRAKE PADS

Usually made from rubber, these rub against the rim to slow the wheel

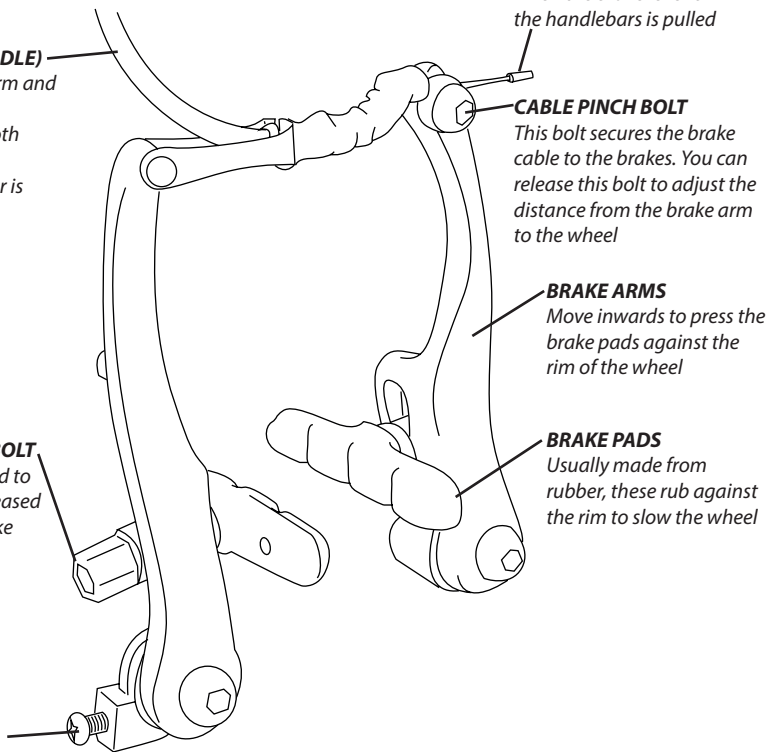

CALIPER BRAKES

If you need to release your caliper brakes to install or replace a wheel, slightly loosen the cable pinch bolt. Turn it anti-clockwise with the spanner provided as shown. This will open up the break pads so the wheel fits through.

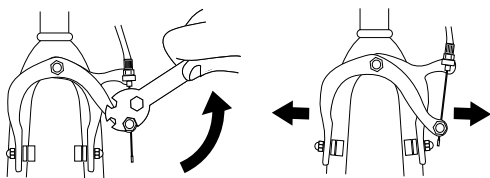

Once the wheel is in place and tight, squeeze the brake arms together until there is a 1 - 1.5 mm gap between the brake pads and the rim. Both sides should be equal. Whilst holding in place you then need to pull the brake cable tight, and tighten the cable pinch bolt by turning clockwise using the spanner provided as shown.

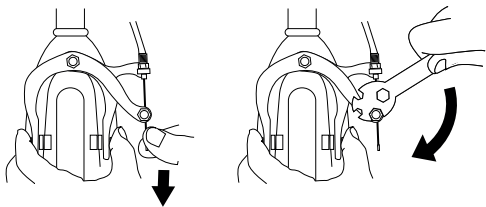

CALIPER ALIGNMENT SCREW

Should one brake pad be closer to the rim than the other, turn this to centre the brake. Check anchoring bolt is tight after adjusting.

ANCHORING BOLT

This bolt holds the brakes on to the frame

CABLE TENSION SCREW

Turn anti-clockwise to fine tune the distance from the brake arms to the wheel when brake pads begin to wear. Once adjusted, tighten locking nut below.

CABLE PINCH BOLT

This bolt secures the brake cable to the brakes. You can release this bolt to adjust the distance from the brake arm to the wheel

BRAKE ARMS

Move inwards to press the brake pads against the rim of the wheel

BRAKE CABLE

Operates the brake arms when the brake lever on the handlebars is pulled

BRAKE PADS

Usually made from rubber, these rub against the rim to slow the wheel

BRAKE PAD ADJUSTMENT BOLT

This bolt secures the brake pad to the brake arm and can be released to move the brake pad up and down in order to align with the rim

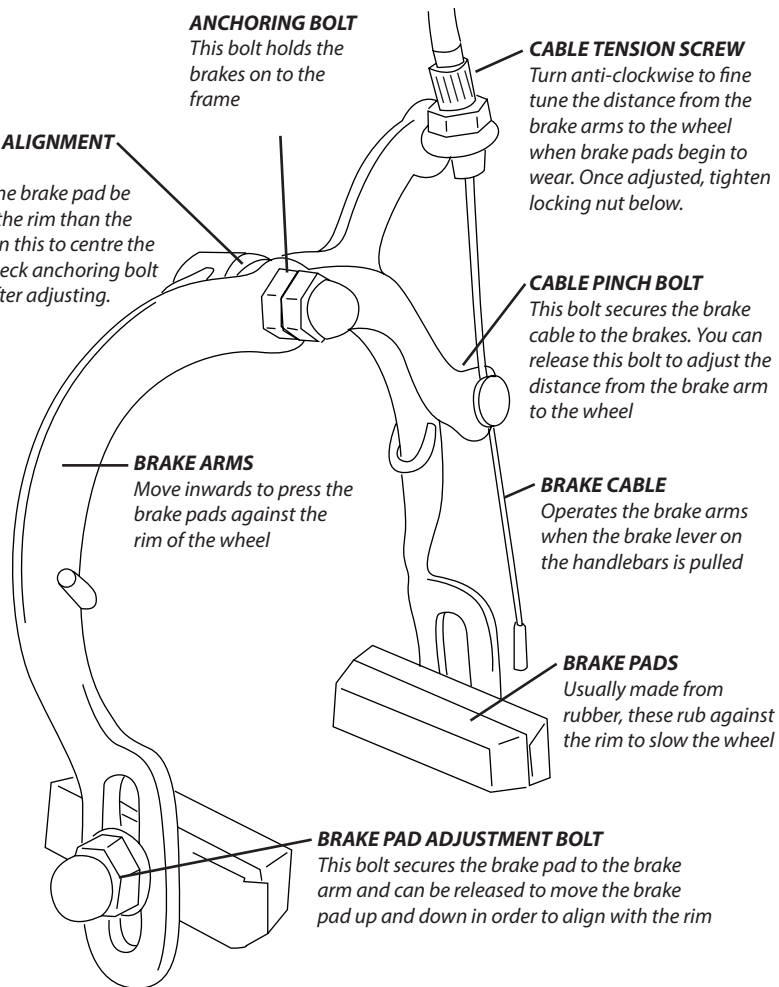

31. GEARS

Before riding your bike make sure your gears are properly adjusted and that you are happy with how the controls work. If your bike is equipped with gears, it will have either one or two shifters.

The shifter fitted to the right hand side of the handlebar controls the rear gears. These are where you have a number of cogs on the rear wheel, and the chain is moved across them by way of a deraillleur.

The LARGEST cog is the LOWEST gear and therefore the most easy to pedal, and the SMALLEST cog is the HIGHEST gear, and the hardest to pedal.

The shifter fitted to the left hand side of the handlebar if you have one, will control the front gears. These gears work the opposite to the rear gears, and the SMALLEST cog is the LOWEST gear.

You should select a lower gear to set off and a higher gear once you get going. Most gear shifters have a number indicator to show which gear number you are in. Try not to leave it until you are struggling before you change gear as this will cause you to lose speed and control. **Never change gear whilst the bike is not moving or the pedals are not turning, as you could damage your gears and move out of adjustment.**

Bikes come with the gears set from the factory, but slight adjustment may be needed before you ride the bike. In this section we will detail the different type of gear changers, and we will also explain how to make slight adjustments to these. Gears should change easily and quietly. If they don't, here you will find basic instructions on how to adjust them. You will need to work out from the images which type of gears you have. There are so many brands and models of gears it is impossible to illustrate them all, but they all have similar functions which you will find in the following pages.

IF YOU ARE UNSURE OR DON'T UNDERSTAND ANY OF THESE STEPS CONSULT A QUALIFIED BICYCLE MECHANIC

Derailleurs

Gears are usually controlled by derailleurs, which are the mechanisms that move the chain up and down the cogs. The rear derailleur is controlled by the right hand gear shifter, and the front derailleurs by the left shifter.

Setting gears on a rear derailleur

- i* Turn the pedals and shift the gear on the right hand gear shifter to the highest number / lowest cog.
- ii* Look at the derailleurs and the cog and these should be in line. If this is not the case, then you can adjust the 'L' screw slightly with a phillips screwdriver until they are.

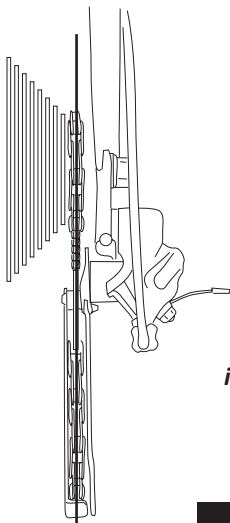

IN LINE

- iii* Change the shifter one position and see if the chain moves up one cog easily. If whilst changing gears the chain will either not change cogs, or changes two cogs at a time, you can adjust the cable tension screw. Each derailleur model is different, so we recommend giving it half a turn one way and testing and then adjusting accordingly until you achieve the desired result.

- iv* Now turn the pedals and change the shifter to the lowest number and largest cog.

- v* You can now check if the chain and derailleurs are in line. If it's not, or if the derailleurs has excessive play towards the wheel, adjust the 'H' screw slightly until they are in line with no play.

LIMITER SCREWS

These are marked 'H' & 'L' and are sometimes found in different positions on the derailleur

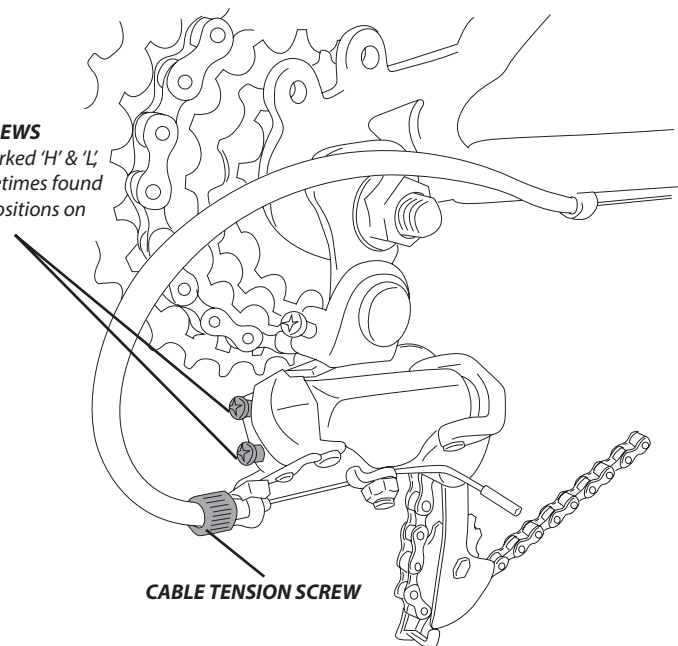

CABLE TENSION SCREW

IF YOU HAVE ANY PROBLEMS OR ARE UNSURE ABOUT ANY OF THESE STEPS, CONSULT A QUALIFIED BICYCLE MECHANIC

Setting gears on a front derailleur

- i* Whilst turning the pedals, set the left hand gear shifter to the lowest gear (smallest cog at the front), and the right hand shifter to the highest gear (smallest cog at the back)
- ii* You should check that the chain is running freely through the cage on the front derailleur without catching. If it catches you can move the cage by slightly adjusting the 'L' screw.
- iii* Leaving the left hand gear shifter where it is, set the right hand shifter to the lowest gear (largest cog) and repeat step 'ii'
- iv* Change the left hand shifter up one gear. If the gear doesn't change smoothly onto the next cog, you can adjust the cable tension screw. For the front derailleur this is found either on the gear shifter (check which one you have in the following section), or on certain road bikes it is found on the downtube of the frame, just above the gear cable guide. Turn slightly and keep testing until you have achieved the desired result.
- v* Once the gears are changing correctly shift the left hand shifter on the highest gear and check that the chain cannot clear the cage and come off the cog over the top. If it can, you can adjust it by slightly turning the 'H' screw with a phillips screwdriver.

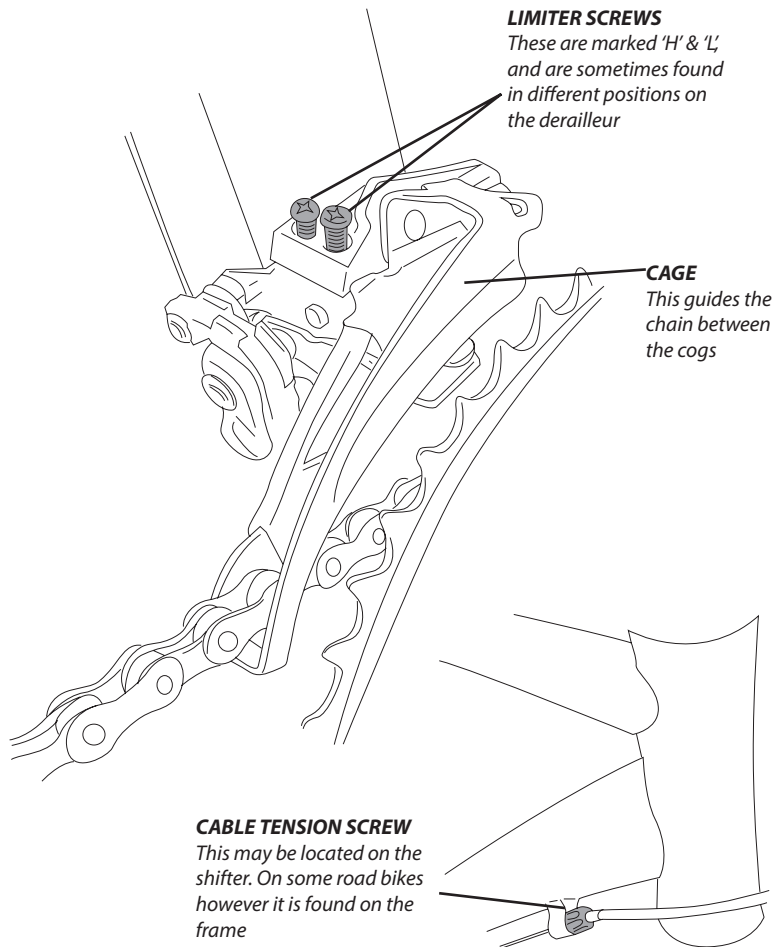

TWIST GRIP

GEAR INDICATOR
Tells you what number gear you are in

GEAR SHIFTER
Rotate to shift gears up and down the cogs

CABLE TENSION SCREW
Can be turned to add or remove slack to the gear cable

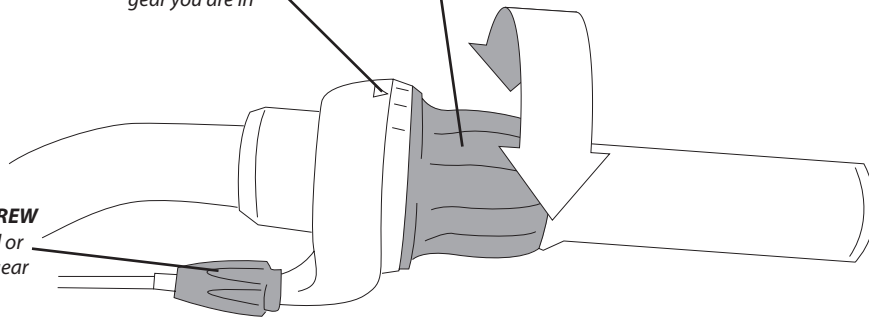

3J ROTOR or GIRO

Some BMX bikes come equipped with what is called a rotor or a giro. This enables the user to turn the handlebar a full 360 degrees without the cables tangling. If you plan to use your BMX for stunt riding, ramps or the like, this may invalidate your warranty.

i Feed the shortest cable through the nearest hole to the brake lever and the longest cable through the furthest hole.

ii Screw the cables in place by turning the cable bolts clockwise as shown. Make sure you screw both sides in tight.

iii You will then need to lift the slotted plate up with one hand and insert the cables so that the stoppers are below the slots with the other hand.

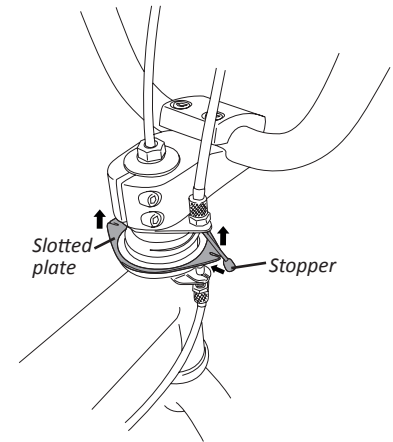
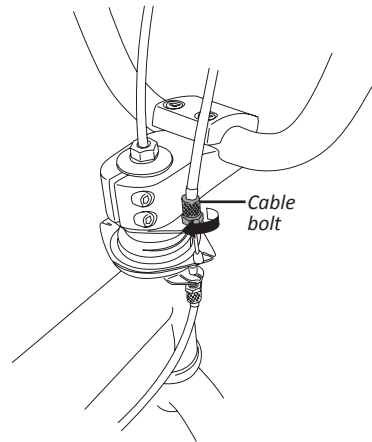
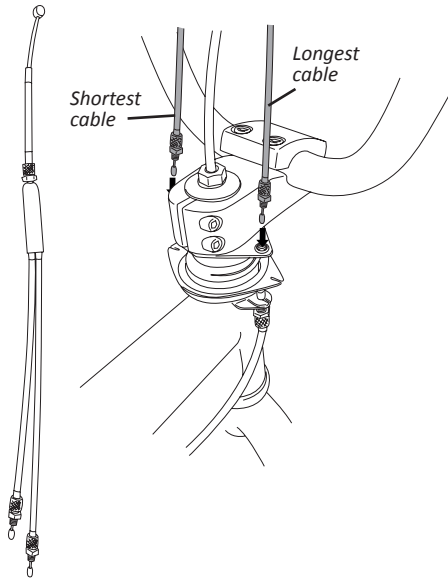

- iv** We then need to fit the cable to the break lever. Ensure the slots on the cable tension screw are in line with the slot on the brake lever housing.
- v** Squeeze the brake lever and insert the brake cable into the slot as shown below.
- vi** With the brake lever closed, you can now pull the brake cable outer casing and insert the cable through the sloths in the brake lever housing and the brake cable tension screw.
- vii** Once the brake cable outer housing has slotted into the brake cable adjusting screw, turn this screw so that the slots are no longer aligned and the cable can no longer come out.

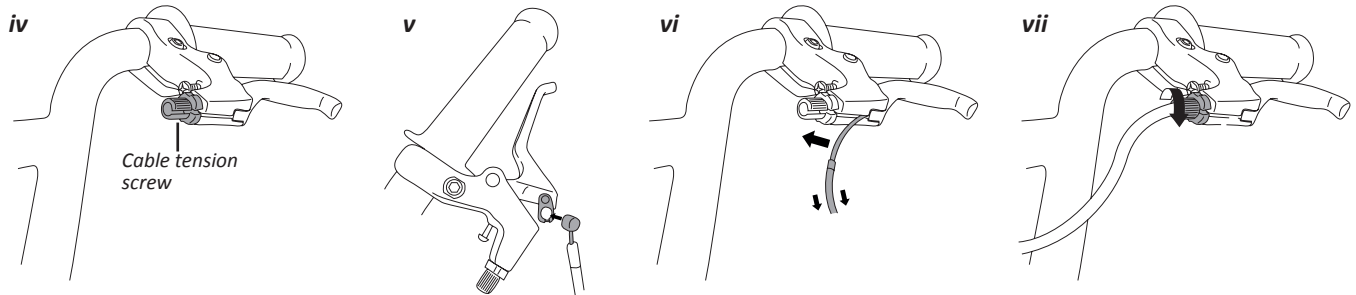

**Always test the brakes before riding. Should you need to adjust them, visit the brakes section of this manual
IF YOU HAVE ANY PROBLEMS OR ARE UNSURE ABOUT ANY OF THESE STEPS, CONSULT A QUALIFIED BICYCLE MECHANIC**

4. Maintenance

Tyres & Tubes

Bicycle tyres come in many designs and specifications for different types of riding. They range from general purpose tyres all the way to specific tyres for different weather / terrain.

Once you get some riding experience on your new bike you may feel that a different type of tyre may suit your needs better. Any bicycle shop will be able to help you choose the correct type of tyre for your style of riding.

All tyres have the pressure ratings on the sidewall, as well as other bits of information such as size, and occasionally intended use.

It is very important that you never inflate a tyre beyond the maximum pressure marked on the sidewall. This could cause it to burst and blow off the rim, which could cause serious injury to both yourself and / or bystanders and pedestrians. It is also not recommended to use garage forecourt or any other type of compressor to pump up your tyres, as these dispense a very large amount of air very quickly, which can cause your tube / tyre to explode.

There are mainly 2 types of valves on bicycles. The Schraeder valve, which is similar to a car tyre and the Presta valve, which is much thinner.

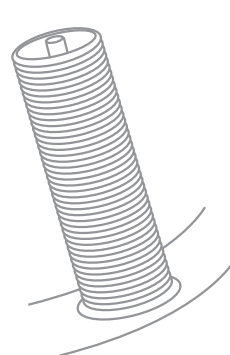
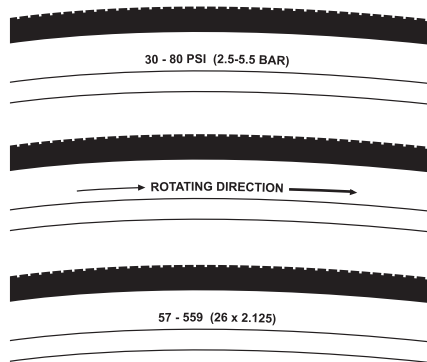

Schraeder Valve

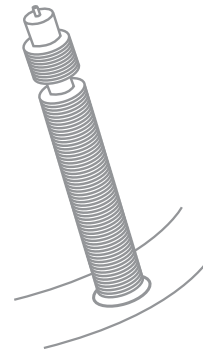

Presta Valve

Replacing an innertube

We recommend you always carry a spare innertube when out on your bike. Puncture repairs are ok for an emergency fix, but an improper repair or too many repairs may cause the innertube to fail, resulting in you losing control and falling.

Remove the wheel from the bicycle, you can follow the wheels section of this manual if you have are unsure on how to do this.

Let all the air out of the tube.

Then insert two tyre levers between the rim and the tyre to prise the tyre off the rim, before removing the innertube from inside the tyre.

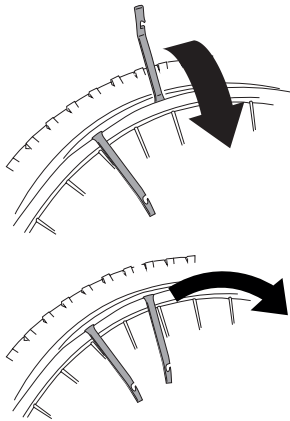

Pump just enough air into the new tube for it to slightly take shape, and insert it in the tyre.

Before putting the tyre back on the rim, ensure the valve goes through the hole in the rim provided

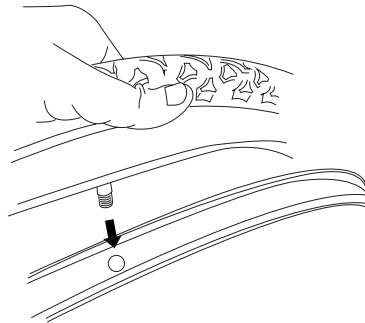

Always check that the rim tape is even around the rim and check the rim for any damage.

Replace the tyre one side at a time or it will become very tight. Once it is almost all the way on, you can use your tyre levers to force back in place.

Remember to pump the wheel up to the recommended pressure setting.

Note: Never use screwdrivers in place of tyre levers as sharp edges may damage the rim. You can however use the handles of metal kitchen spoons as long as these no have sharp edges.

Break-in Period:

Your bike will last longer and work better if you break it in before riding it hard. Control cables and wheel spokes may stretch or “seat” when a new bike is first used and may require readjustment. This manual will help you identify some things that need readjustment. But even if everything seems fine to you, it is often best to take your bike to your local mechanic for a checkup. Dealers typically suggest you bring the bike in for a 30 day checkup. Another way to judge when it’s time for the first checkup is to take the bike in after three to five hours of hard off-road use, or about 10 to 15 hours of on-road or more casual off-road use. But if you think something is wrong with the bike, take it to your mechanic before riding it again.

Before every ride: See point 2: Safety

After every long or hard ride: If the bike has been exposed to water or grit; or at least every 100 miles: Clean the bike and lightly lubricate the chain’s rollers with a good quality bicycle chain lubricant. Wipe off excess lubricant with a lintfree cloth. Lubrication is a function of climate. Talk to your local mechanic about the best lubricants and the recommended lubrication frequency for your area.

After every long or hard ride or after every 10 to 20 hours of riding:

- Squeeze the front brake and rock the bike forward and back. Everything feel solid? If you feel a clunk with each forward or backward movement of the bike, you probably have a loose headset.
- Lift the front wheel off the ground and swing it from side to side. Feel smooth? If you feel any binding or roughness in the steering, you may have a tight headset.
- Grab one pedal and rock it toward and away from the centerline of the bike; then do the same with the other pedal. Anything feel loose? If so, have a qualified bicycle mechanic check it.
- Take a look at the brake pads. Starting to look worn or not hitting the wheel rim squarely? They may need adjusting or repairing, see the brakes section of this manual.
- Carefully check the control cables and cable housings. Any rust? Kinks? Fraying? If so, have a qualified bicycle mechanic replace them.
- Squeeze each adjoining pair of spokes on either side of each wheel between your thumb and index finger. Do they all feel about the same? If any feel loose, have the wheel checked for tension and trueness.
- Check the tyres for excess wear, cuts or bruises.
- Check the wheel rims for excess wear, dings, dents and scratches. As a qualified bicycle mechanic if they need replacing.
- Check to make sure that all parts and accessories are still secure, and tighten any which are not.

- Check the frame, particularly in the area around all tube joints; the handlebars; the stem; and the seatpost for any deep scratches, cracks or discoloration. These are signs of stress-caused fatigue and indicate that a part is at the end of its useful life and needs to be replaced.

As required:

- If either brake fails, don't ride the bike. Have your local mechanic check the brakes.
- If the chain won't shift smoothly and quietly from gear to gear, the derailleur is out of adjustment, take it to a qualified bicycle mechanic.

Every 25 (hard off-road) to 50 (on-road) hours of riding: Take your bike to a qualified bicycle mechanic for a complete checkup.

If you have an accident

First, check yourself for injuries, and take care of them as best you can. Seek medical help if necessary.

Next, check your bike for damage. After any crash, take your bike to your local mechanic for a thorough check. Carbon composite components, including frames, wheels, handlebars, stems, cranksets, brakes, etc. which have sustained an impact must not be ridden until they have been disassembled and thoroughly inspected by a qualified mechanic.

Cleaning & Lubrication

It is important in order to keep your bike in good and safe working order to make sure it is clean and lubricated. Always wash off any excess dirt and dry well, before lubricating moving parts. Below is a guide that may help you with your maintenance schedule, but this will depend on how and where you ride and also on how often you ride.

Do not over lubricate and ALWAYS wipe off any excess lubrication, specially if you get it on the brakes, brake pads or rims, and this may decrease brake functionality and increase stopping distance. If you have any doubts about any of these parts, please consult a qualified bicycle mechanic.

What Part?	How often?	What with?	How?
Chain	Every week	Light oil	Brush or spray
Derailleurs	Every week	Oil	Oil can
Brakes & Levers	Every week	Oil	Oil can
<hr/>			
Gear Levers	Every month	Lithium based grease	Disassemble
<hr/>			
Freewheel	Every six months	Oil	Oil can
Brake Cables	Every six months	Lithium based grease	Disassemble
<hr/>			
Bottom bracket	Every year	Lithium based grease	Disassemble
Pedals	Every year	Lithium based grease	Disassemble
Gear cables	Every year	Lithium based grease	Disassemble
Wheel bearings	Every year	Lithium based grease	Disassemble
Headset	Every year	Lithium based grease	Disassemble
Seat post	Every year	Lithium based grease	Disassemble

5. Torque Specifications

Correct tightening torque of threaded fasteners is very important to your safety. Always tighten fasteners to the correct torque. In case of a conflict between the instructions in this manual and information provided by a component manufacturer, consult with a qualified bicycle mechanic or the manufacturer's customer service representative for clarification. Bolts that are too tight can stretch and deform. Bolts that are too loose can move and fatigue.

Either mistake can lead to a sudden failure of the bolt. Always use a correctly calibrated torque wrench to tighten critical fasteners on your bike. Carefully follow the torque wrench manufacturer's instructions on the correct way to set and use the torque wrench for accurate results.

Threaded Headset Locknut	16-24 Nm (142-212in-lb)	Disc Brake Rotor To Hub	4-7 Nm (36-60in-lb)
Stem Expander Bolt (quill type)	17-22 Nm (150-195in-lb)	Disc Brake Caliper Mount	6-9 Nm (52-84in-lb)
Handlebar Binder Bolt (quill type)	17-22 Nm (150-195in-lb)	Brake Caliper Mount to Frame (side/dual)	8-9.5 Nm (70-85in-lb)
Stem Binder Bolt (threadless)	13.5-16 Nm (120-144in-lb)	Brake Caliper Mount to Braze-on Linear Pull/Cantilever	5-7 Nm (44-60in-lb)
Compression Cap	2-3 Nm (20-26in-lb)	Brake Pad (Threaded Stud, Dual Pivot/Sidepull)	5-7 Nm (44-60in-lb)
Stem Faceplate Bolts	13.5-19 Nm (120-168in-lb)	Brake Pad (Smooth Stud,)	8-9 Nm (70-78in-lb)
		Brake Cable Pinch Bolt (Linear Pull)	6-8 Nm (53-69in-lb)
Pedal	34.5-40 Nm (307-354in-lb)	Brake Cable Pinch Bolt (Sidepull/ Dual Pivot)	6-8 Nm (53-69in-lb)
Crank Arm	45-50Nm (398-442in-lb)	Brake Caliper Arm Pivot (Dual Pivot)	8-9.5 Nm (70-85in-lb)
		Sidepull/Dual Pivot Brake Pad Bolt	5-7 Nm (44-60in-lb)
Axle Nut	30-42 Nm (260-372in-lb)	Cantilever Straddle Wire Pinch 5 x 0.8 Thread	4-5 Nm (35-43in-lb)
		Brake Caliper Wire Pinch Linear Pull	5.5-8.5 Nm (50-75in-lb)
Seat Post Binder	4-6.5 Nm (36-60in-lb)	Brake Lever (MTB type)	6-8 Nm (53-69in-lb)
Seat Rail Binder	18-34 Nm (160-300in-lb)	Brake Lever (Drop Bar Type)	6-8 Nm (53-69in-lb)
Shift Lever	6-8 Nm (53-70in-lb)	Mudguard Bolts 6-9 Nm (53-78in-lb)	6-9 Nm (53-78in-lb)
Rear Derailleur Mounting Bolt	8-10 Nm (70-86in-lb)	Mudguard Bracket Bolts 2.5-4 Nm (25-35in-lb)	2.5-4 Nm (25-35in-lb)
Rear Derailleur Cable Pinch Bolt	4-5 Nm (35-45in-lb)		
Rear Derailleur Pulley Wheel Bolt	3-4 Nm (27-36in-lb)	Base Clip Bolts	2.5-4 Nm (25-35ft-lb)
		Mount Bracket Bolts	2.5-4 Nm (25-35ft-lb)
		Strut Bolts	2.5-4 Nm (25-35ft-lb)

7. Warranty Statement

Argos offers a 2 year warranty on steel frames and rigid forks for any problems relating to manufacturer workmanship or arising from material defects including breakages or cracking caused while riding (other than rider misuse).

All other components including aluminium frames and forks are guaranteed for 1 year for problems relating to manufacturer workmanship or arising from material defects with the exception of consumable components for example brake blocks, pads, tyres and tubes.

Transport and labour charges in relation to warranty supplied parts are not subject to the terms of this guarantee and shall be the responsibility of the owner.

The original bill of sale or proof of purchase must be presented to the approved dealer prior to obtaining warranty services.

This guarantee does not cover failure experienced during activities such as stunt riding, wheelies, jumping or competition riding of any kind.

Argos offers this warranty to the original purchaser of the product. This warranty is not transferable to a third party.

The above guarantee is in addition to your statutory rights.



CUSTOMER SERVICE NUMBER:
0161 509 4960

IMPORTED BY
ARGOS MK9 2NW

Argos MK9 2NW. Argos (N.I.) BT8 6FX. Argos Distributors (Ireland) A84 YY86



CUSTOMER SERVICE NUMBER:

0161 509 4960