



# HOVER

- HOZP717IN

## USER INSTRUCTIONS

OVENS \_\_\_\_\_ EN **02**

## NOTICE D'EMPLOI ET D'INSTALLATION

DES FOURS ENCASTRABLES \_\_\_\_\_ FR **15**

## MANUALE D'ISTRUZIONI

FORNO \_\_\_\_\_ IT **30**

## INSTRUCCIONES DE USO

HORNOS EMPOTRABLES \_\_\_\_\_ ES **43**

## BEDIENUNGSANLEITUNG

BACKOFEN \_\_\_\_\_ DE **56**

## KULLANIM KILAVUZU

FIRINLAR \_\_\_\_\_ TR **69**

## POKYNY PRO UŽIVATELE

TROUBY \_\_\_\_\_ CZ **84**

## BEDIENUNGSANLEITUNG

BACKOFEN \_\_\_\_\_ SL **97**

## RÚRA NA PEČENIE

NÁVOD NA POUŽITIE \_\_\_\_\_ SK **110**

## Safety Indications

---

- **WARNING:** the appliance and accessible parts become hot during use. Be careful not to touch any hot parts.
- **WARNING:** the accessible parts can become hot when the oven is in use. Children must be kept at a safe distance.
- **WARNING:** ensure that the appliance is switched off before replacing the bulb, to avoid the possibility of electric shocks.
- **WARNING:** before initiating the automatic cleaning cycle:
  - Clean the oven door;
  - Remove large or coarse food residues from the inside of the oven using a damp sponge. Do not use detergents;
  - Remove all accessories and the sliding rack kit (where present);
  - Do not place tea towels
- In ovens with meat probe it is necessary, before making the cleaning cycle, close the hole with the nut provided. Always close the hole with the nut when the meat probe is not used.
- Children under 8 must be kept at a safe distance from the appliance if not continuously supervised.
- Children must not play with the appliance. The appliance can be used by those aged 8 or over and by those with limited physical, sensorial or mental capacities, without experience or knowledge of the product, only if supervised or provided with instruction as to the operation of the appliance, in a safe way with awareness of the possible risks.
- Cleaning and maintenance should not be carried out by unsupervised children.
- Do not use rough or abrasive materials or sharp metal scrapers to clean the oven door glasses, as they can scratch the surface and cause the glass to shatter.
- The oven must be switched off before removing the removable parts and, after cleaning, reassemble them according the instructions.
- Only use the meat probe recommended for this oven.
- Do not use a steam cleaner for cleaning operations.
- Connect a plug to the supply cable that is able to bear the voltage, current and load indicated on the tag and having the earth contact. The

socket must be suitable for the load indicated on the tag and must be having the earth contact connected and in operation. The earth conductor is yellow-green in colour. This operation should be carried out by a suitably qualified professional. In case of incompatibility between the socket and the appliance plug, ask a qualified electrician to substitute the socket with another suitable type. The plug and the socket must be conformed to the current norms of the installation country. Connection to the power source can also be made by placing an omnipolar breaker between the appliance and the power source that can bear the maximum connected load and that is in line with current legislation. The yellow-green earth cable should not be interrupted by the breaker. The socket or omnipolar breaker used for the connection should be easily accessible when the appliance is installed.

- The disconnection may be achieved by having the plug accessible or by incorporating a switch in the fixed wiring in accordance with the wiring rules.
- If the power cable is damaged, it must be substituted with a cable or special bundle available from the manufacturer or by contacting the customer service department.
- The type of power cable must be H05V2V2-F.
- Failure to comply with the above can compromise the safety of the appliance and invalidate the guarantee.
- Any excess of spilled material should be removed before cleaning.
- During the pyrolytic cleaning process, surfaces can heat up more than usual, children must therefore be kept at a safe distance.
- The appliance must not be installed behind a decorative door in order to avoid overheating.
- When you place the shelf inside, make sure that the stop is directed upwards and in the back of the cavity.

The shelf must be inserted completely into the cavity

- **WARNING:** Do not line the oven walls with aluminum foil or single-use protection available from stores. Aluminum foil or any other protection, in direct contact with the hot enamel, risk melting and deteriorating the enamel of the insides.
- **WARNING:** Never remove the oven door seal.

## General Instructions

# 5

- 1.1 Safety indications
- 1.2 Electrical safety
- 1.3 Recommendations
- 1.4 Installation
- 1.5 Waste management
- 1.6 Conformity declaration

## Product Description

# 7

- 2.1 Overview
- 2.2 Accessories
- 2.3 First use

## Use of the Oven

# 8

- 3.1 Display description
- 3.2 Cooking modes

## Oven Cleaning and Maintenance

# 12

- 4.1 General notes on cleaning
- 4.2 Maintenance
  - Removal and cleaning of grills
  - Removal of the oven window
  - Removal and cleaning of the glass door
  - Changing the bulb

## Troubleshooting

# 14

- 5.1 F.A.Q.

# 1. General Instructions

---

We thank you for choosing one of our products. For the best results with your oven, you should read this manual carefully and retain it for future reference. Before installing the oven, take note of the serial number so that you can give it to customer service staff if any repairs are required. Having removed the oven from its packaging, check that it has not been damaged during transportation. If you have doubts, do not use the oven and refer to a qualified technician for advice. Keep all of the packaging material (plastic bags, polystyrene, nails) out of the reach of children. When the oven is switched on for the first time, strong smelling smoke can develop, which is caused by the glue on the insulation panels surrounding the oven heating for the first time. This is absolutely normal and, if it occurs, you should wait for the smoke to dissipate before putting food in the oven. The manufacturer accepts no responsibility in cases where the instructions contained in this document are not observed.



**NOTE:** the oven functions, properties and accessories cited in this manual will vary, depending on the model you have purchased.

## 1.1 Safety Indications

---

Only use the oven for its intended purpose, that is only for the cooking of foods; any other use, for example as a heat source, is considered improper and therefore dangerous. The manufacturer cannot be held responsible for any damage resulting from improper, incorrect or unreasonable usage.

The use of any electrical appliance implies the observance of some fundamental rules:

- do not pull on the power cable to disconnect the plug from the socket;
- do not touch the appliance with wet or damp hands or feet;
- in general the use of adaptors, multiple sockets and extension cables is not recommended;
- in case of malfunction and/or poor operation, switch off the appliance and do not tamper with it.

## 1.2 Electrical Safety

---

### **ENSURE THAT AN ELECTRICIAN OR QUALIFIED TECHNICIAN MAKES THE ELECTRICAL CONNECTIONS.**

The power supply to which the oven is connected must conform with the laws in force in the country of installation. The manufacturer accepts no responsibility for any damage caused by the failure to observe these instructions. The oven must be connected to an electrical supply with an earthed wall outlet or a disconnecter with multiple poles, depending on the laws in force in the country of installation. The electrical supply should be protected with suitable fuses and the cables used must have a transverse section that can ensure correct supply to the oven.

### **CONNECTION**

The oven is supplied with a power cable that should only be connected to an electrical supply with 220-240 Vac 50 Hz power between the phases or between the phase and neutral. Before the oven is connected to the electrical supply, it is important to check:

- power voltage indicated on the gauge;
- the setting of the disconnecter.

The grounding wire connected to the oven's earth terminal must be connected to the earth terminal of the power supply.

### **WARNING**

Before connecting the oven to the power supply, ask a qualified electrician to check the continuity of the power supply's earth terminal. The manufacturer accepts no responsibility for any accidents or other problems caused by failure to connect the oven to the earth terminal or by an earth connection that has defective continuity.

**NOTE:** as the oven could require maintenance work, it is advisable to keep another wall socket available so that the oven can be connected to this if it is removed from the space in which it is installed. The power cable must only be substituted by technical service staff or by technicians with equivalent qualifications.

### 1.3 Recommendations

---

After each use of the oven, a minimum of cleaning will help keep the oven perfectly clean.

Do not line the oven walls with aluminium foil or single-use protection available from stores. Aluminium foil or any other protection, in direct contact with the hot enamel, risks melting and deteriorating the enamel of the insides. In order to prevent excessive dirtying of your oven and the resulting strong smokey smells, we recommend not using the oven at very high temperature. It is better to extend the cooking time and lower the temperature a little. In addition to the accessories supplied with the oven, we advise you only use dishes and baking moulds resistant to very high temperatures.

### 1.4 Installation

---

The manufacturers have no obligation to carry this out. If the assistance of the manufacturer is required to rectify faults arising from incorrect installation, this assistance is not covered by the guarantee. The installation instructions for professionally qualified personnel must be followed. Incorrect installation may cause harm or injury to people, animals or belongings. The manufacturer cannot be held responsible for such harm or injury.

The oven can be located high in a column or under a worktop. Before fixing, you must ensure good ventilation in the oven space to allow proper circulation of the fresh air required for cooling and protecting the internal parts. Make the openings specified on last page according to the type of fitting.

### 1.5 Waste management and environmental protection

---



This appliance is labelled in accordance with European Directive 2012/19/EU regarding electric and electronic appliances (WEEE). The WEEE contain both polluting substances (that can have a negative effect on the environment) and base elements (that can be reused). It is important that the WEEE undergo specific treatments to correctly remove and dispose of the pollutants and recover all the materials. Individuals can play an important role in ensuring that the WEEE do not become an environmental problem; it is essential to follow a few basic rules:

- the WEEE should not be treated as domestic waste;
- the WEEE should be taken to dedicated collection areas managed by the town council or a registered company.

In many countries, domestic collections may be available for large WEEEs. When you buy a new appliance, the old one can be returned to the vendor who must accept it free of charge as a one-off, as long as the appliance is of an equivalent type and has the same functions as the purchased appliance.

#### **SAVING AND RESPECTING THE ENVIRONMENT**

Where possible, avoid pre-heating the oven and always try to fill it. Open the oven door as infrequently as possible, because heat from the cavity disperses every time it is opened. For a significant energy saving, switch off the oven between 5 and 10 minutes before the planned end of the cooking time, and use the residual heat that the oven continues to generate. Keep the seals clean and in order, to avoid any heat dispersal outside of the cavity. If you have an electric contract with an hourly tariff, the "delayed cooking" programme makes energy saving more simple, moving the cooking process to start at the reduced tariff time slot.

### 1.6 Declaration of compliance

---

The parts of this appliance that may come into contact with foodstuffs comply with the provisions of EEC Directive 89/109.

By placing the **CE** mark on this product, we are confirming compliance to all relevant European safety, health and environmental requirements which are applicable in legislation for this product.

## 2. Product Description

### 2.1 Overview



1. Control panel
2. Shelf positions (lateral wire grid if included)
3. Metal grill
4. Drip pan
5. Fan (behind the steel plate)
6. Oven door

### 2.2 Accessories (according to the model)

#### 1 Drip pan



Collects the residues that drip during the cooking of foods on the grills.

#### 2 Metal grill

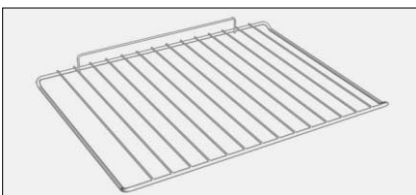

Holds baking trays and plates.

#### 3 Lateral wire grids



Lateral wire grid if included.

#### 4 Grill pan set

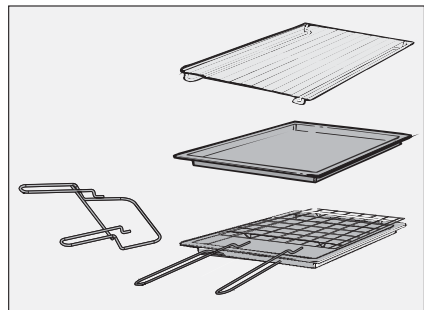

The simple shelf can take moulds and dishes. The tray holder shelf is especially good for grilling things. Use it with the drip tray.

*The special profile of the shelves means they stay horizontal even when pulled right out. There is no risk of a dish sliding or spilling.*

The drip tray catches the juices from grilled foods. It is only used with the Grill, Rotisserie, or Fan Assisted Grill ; remove it from the oven for other cooking methods.

*Never use the drip tray as a roasting tray as this creates smoke and fat will spatter your oven making it dirty.*

The tray holder

The tray holder shelf is ideal for grilling. Use it in conjunction with the drip tray. A handle is included to assist in moving the both accessories safely. Do not leave the handle inside the oven.

## 2.3 First Use

### PRELIMINARY CLEANING

Clean the oven before using for the first time. Wipe over external surfaces with a damp soft cloth. Wash all accessories and wipe inside the oven with a solution of hot water and washing up liquid. Set the empty oven to the maximum temperature and leave on for about 1 hour, this will remove any lingering smells of newness.

## 3. Use of the Oven

### 3.1 Display description



**ON / OFF**  → The oven is switched on and off with this button.



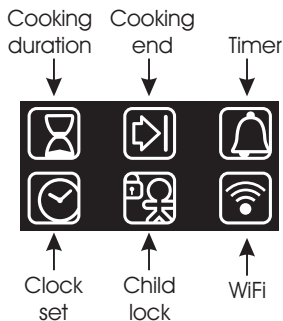

**EXTRA**  →



If the oven is switched off, the display shows the clock. When the oven is inactive, all the functions are available except the cooking duration and end of cooking.

If the clock is not set, the oven does not work: the display flashes, showing "12:00" and the only functioning key is Extra. From the Extra key, the following functions can be set:



FUNCTION	HOW TO USE	HOW TO DEACTIVATE	WHAT IT DOES	WHY IT IS NEEDED
<b>COOKING DURATION</b> 	<p>NB: can only be set with an active cooking programme. Press EXTRA twice and set the time using the "+" and "-" keys, confirming by pressing "SELECT".</p> <p>The display shows "00:00" if no cooking duration has been inserted, otherwise the display shows the time remaining.</p>	<ul style="list-style-type: none"> <li>To modify cooking before the set time, press EXTRA twice and regulate the cooking time as required using the "&lt;" and "&gt;" keys, before pressing "SELECT" once more.</li> <li>To cancel the cooking duration, reset the display to "00:00".</li> </ul>	<p>When a cooking programme terminates, the oven switches off while the display shows "END" (the cooking programme icon remains on) until the On/Off button, the only functioning key, is pressed. When a cooking programme terminates, an alarm will sound.</p>	<p>When the cooking time has finished, the oven automatically switches off and the alarm sounds for a few seconds.</p>
<b>END OF COOKING</b> 	<p>NB: can only be set with an active cooking programme. Press EXTRA enough times to illuminate the icon, set the end of cooking time using the "&lt;" and "&gt;" keys and confirm by pressing "SELECT".</p> <p>Press EXTRA enough times to illuminate the icon, set the end of cooking time using the "&lt;" and "&gt;" keys and confirm by pressing "SELECT".</p> <p>The cooking duration is automatically calculated.</p>	<p>To modify the end of cooking before the set time, press EXTRA enough times to illuminate the icon, regulate the end of cooking time as required using the "&lt;" and "&gt;" keys and confirm by pressing "SELECT".</p> <p>To cancel the end of cooking time, reset the display to "00:00".</p>	<p>When a cooking programme terminates, the oven switches off while the display shows "END" (the cooking programme icon remains on) until the On/Off button, the only functioning key, is pressed. When a cooking programme terminates, an alarm will sound.</p>	<ul style="list-style-type: none"> <li>This function is also used for cooking that can be scheduled in advance.</li> <li>If a cooking programme is set, it will be lost if the "F" key is pressed.</li> <li>If delayed cooking is set, the oven switches off and the display shows the current time while the cooking programme, cooking duration and end of cooking icons are illuminated.</li> <li>If a cooking programme is set, by pressing the "&lt;" and "&gt;" keys you can see and modify the temperature set: at the first touch, the operating temperature is shown while another touch will allow you to modify said temperature.</li> </ul>
<b>TIMER</b> 	<ul style="list-style-type: none"> <li>The display shows "00:00" if no time has been inserted or the time remaining if this has already been set.</li> </ul> <p>Press EXTRA enough times to illuminate the icon and use the "&lt;" and "&gt;" keys to set the time, confirming by pressing SELECT.</p>	<ul style="list-style-type: none"> <li>To modify the timer, press EXTRA enough times to illuminate the icon, regulate the cooking time as required using the "&lt;" and "&gt;" keys and confirm by pressing "SELECT".</li> </ul>	<ul style="list-style-type: none"> <li>This function activates an alarm that sounds for a few seconds when the set time expires (this function does not switch the oven off). You can select a time between 00:00 and 23:59.</li> </ul>	<ul style="list-style-type: none"> <li>The timer functions regardless of whether the oven is switched on.</li> </ul>
<b>SETTING THE CLOCK</b> 	<ul style="list-style-type: none"> <li>Switched on for the first time, the display illuminates and shows "12:00".</li> </ul> <p>To modify the time, press EXTRA enough times to illuminate the icon and use the "&lt;" and "&gt;" keys to set the time, confirming it by pressing SELECT.</p>		<ul style="list-style-type: none"> <li>It allows you to set the time that appears on the display.</li> </ul>	<ul style="list-style-type: none"> <li>The alarm functions regardless of whether the oven is switched on.</li> </ul>
<b>CHILD SAFETY</b> 	<ul style="list-style-type: none"> <li>Press the EXTRA key enough times to illuminate the icon and then either the "&lt;" or "&gt;" key to activate this function: the display will show ON; to confirm press SELECT.</li> </ul>	<ul style="list-style-type: none"> <li>Press the EXTRA key enough times to illuminate the icon and then either the "&lt;" or "&gt;" key to deactivate this function: the display will show OFF; to confirm press SELECT.</li> </ul>	<ul style="list-style-type: none"> <li>If the function is active only the "Extra" button, to deactivate the function, and "On/Off" button can be used.</li> </ul>	<ul style="list-style-type: none"> <li>This function is useful when there are children in the house.</li> </ul>

**WiFi (depends on the oven model)** → Pressing "Extra" on the timer display allows you to select the Wi-Fi menu. In the Wi-Fi menu if you press the "<>" buttons you can select:

- **Off:** Wi-Fi is off; the oven is not controllable via the app.
- **On:** Wi-Fi is on and the oven is only controllable via the app. It means that it is not possible to select cooking functions, recipes and temperature from the display. Only the Wi-Fi menu is available by pressing "Extra". You can switch the oven off using the On/Off button, but you cannot switch it back on again via the display, it can only be switched on via the app.
- **Reset:** This setting should be used to enrol the oven the first time it connects to your Wi-Fi network and to reset the current Wi-Fi connection to allow a new enrolment. Once selected, the appliance gives you 5 minutes to complete the enrolment process. During this process the cooking functions, recipes and temperature setting are not accessible from the display. Only the Wi-Fi menu is available by pressing "Extra". You can switch the oven off using the On/Off button, but you cannot switch it back on again via the display, it can only be switched on via the app. To exit the enrolment/reset procedure via the display, press "Extra" and then use "< >" buttons to select "Off". After five minutes, the appliance will exit the enrolment/reset procedure automatically.
- **Read:** the oven sends its status to the app but it cannot be controlled remotely. The oven must be enrolled before this is possible.

If Wi-Fi is not configured it is only possible to choose between off and reset.

When the oven is connected to Wi-Fi, the default cooking time duration is 5 hours, but this can be modified by the user.

### Wi-Fi Enrolment:

To enroll the appliance for Wi-Fi, press "Extra" on the display until the Wi-Fi icon lights, then select "Reset" by pressing "< >". The procedure on the app should then be followed. Once selected, the appliance gives you 5 minutes to complete the enrolment process.

### Wi-Fi icon

- icon not lit: Wi-Fi is off.
- Icon blinks 1 second on and 1 second off: the oven is accessible to your Wi-Fi network and ready to be enrolled. If the enrolment has not been successful, the Wi-Fi icon will switch off after 5 minutes.
- Icon is permanently lit: the oven is connected to your Wi-Fi router.
- The icon blinks 3 seconds on and 1 second off: the oven is trying to connect to your Wi-Fi router.
- The icon blinks 1 second on and 3 seconds off: the oven is in read only mode.



### HOVER ONEFi<sup>®</sup>:

For detailed information on HOW TO CONNECT your OneFi appliance and HOW TO USE IT effectively, go to <http://wizardservice.candy-hoover.com/>

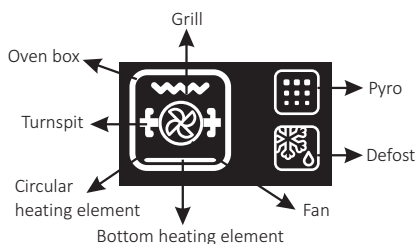









**LANGUAGE SETTING** → The language can be set when the oven is switched off by pressing the Extra and Select buttons simultaneously and for 3". The current language is shown on the display and can be changed by pressing the "<" or ">" keys, confirming it by pressing SELECT. Available languages are: Italian, English, French and German.

**SELECT** → Any selection must be confirmed. If not confirmed within 15 seconds, the selection is cancelled. By changing menu, any unconfirmed selection is lost.

**"HOT" ICON** → When a cooking programme finishes or when the oven switches off, if the oven is still hot, the display shows the current time alternating with the message "HOT" at 3" intervals.

## 3.2 Cooking Modes

Function Dial	T °C default	T °C range	Function <i>(Depends on the oven model)</i>
			<b>LAMP:</b> Turns on the oven light.
	40	40 ÷ 40	<b>DEFROST:</b> When the dial is set to this position. The fan circulates air at room temperature around the frozen food so that it defrosts in a few minutes without the protein content of the food being changed or altered.
 	180 210	50 ÷ 240 50 ÷ 240	<b>FAN COOKING:</b> We recommend you use this method for poultry, pastries, fish and vegetables. Heat penetrates into the food better and both the cooking and preheating times are reduced. You can cook different foods at the same time with or without the same preparation in one or more positions. This cooking method gives even heat distribution and the smells are not mixed. Allow about ten minutes extra when cooking foods at the same time.
* 	220	50 ÷ 280	<b>CONVENTIONAL COOKING:</b> Both top and bottom heating elements are used. Preheat the oven for about ten minutes. This method is ideal for all traditional roasting and baking. For seizing red meats, roast beef, leg of lamb, game, bread, foil wrapped food (papillotes), flaky pastry. Place the food and its dish on a shelf in mid position.
	210	50 ÷ 230	<b>BOTTOM:</b> Using the lower element. Ideal for cooking all pastry based dishes. Use this for flans, quiches, tarts, pate and any cooking that needs more heat from below.
	210	50 ÷ 230	<b>FAN + LOWER ELEMENT:</b> The bottom heating element is used with the fan circulating the air inside the oven. This method is ideal for juicy fruit flans, tarts, quiches and pâté. It prevents food from drying and encourages rising in cakes, bread dough and other bottom-cooked food. Place the shelf in the bottom position.
	200	150 ÷ 220	<b>FAN ASSISTED GRILL :</b> use the turbo-grill with the door closed. The top heating element is used with the fan circulating the air inside the oven. Preheating is necessary for red meats but not for white meats. Ideal for cooking thick food items, whole pieces such as roast pork, poultry, etc. Place the food to be grilled directly on the shelf centrally, at the middle level. Slide the drip tray under the shelf to collect the juices. Make sure that the food is not too close to the grill. Turn the food over halfway through cooking.
	L3	L1 ÷ L5	<b>GRILL:</b> use the grill with the door closed. The top heating element is used alone and you can adjust the temperature. Five minutes preheating is required to get the elements red-hot. Success is guaranteed for grills, kebabs and gratin dishes. White meats should be put at a distance from the grill; the cooking time is longer, but the meat will be tastier. You can put red meats and fish fillets on the shelf with the drip tray underneath. The oven has two grill positions: Grill: 2140 W    Barbecue: 3340 W

\*Tested in accordance with the CENELEC EN 60350-1 used for definition of energy class.

## 4. Oven cleaning and maintenance

---

### 4.1 General notes on cleaning

---

The lifecycle of the appliance can be extended through regular cleaning. Wait for the oven to cool before carrying out manual cleaning operations. Never use abrasive detergents, steel wool or sharp objects for cleaning, so as to not irreparably damage the enamelled parts. Use only water, soap or bleach-based detergents (ammonia).

#### **GLASS PARTS**

It is advisable to clean the glass window with absorbent kitchen towel after every use of the oven. To remove more obstinate stains, you can use a detergent-soaked sponge, well wrung out, and then rinse with water.

#### **OVEN WINDOW SEAL**

If dirty, the seal can be cleaned with a slightly damp sponge.

#### **ACCESSORIES**

Clean accessories with a wet, soapy sponge before rinsing and drying them: avoid using abrasive detergents.

#### **DRIP PAN**

After using the grill, remove the pan from the oven. Pour the hot fat into a container and wash the pan in hot water, using a sponge and washing-up liquid.

If greasy residues remain, immerse the pan in water and detergent. Alternatively, you can wash the pan in the dishwasher or use a commercial oven detergent. Never put a dirty pan back into the oven.

### 4.2 Maintenance

---

#### **REMOVAL AND CLEANING OF THE SIDE RACKS**

1. Unscrew the bolt in an anti-clockwise direction.
2. Remove the side racks by pulling them towards you.
3. Clean the side racks in a dishwasher or with a wet sponge and then dry them immediately.
4. Having cleaned the side racks, put them back in and reinsert the bolts, ensuring that they are fully tightened.

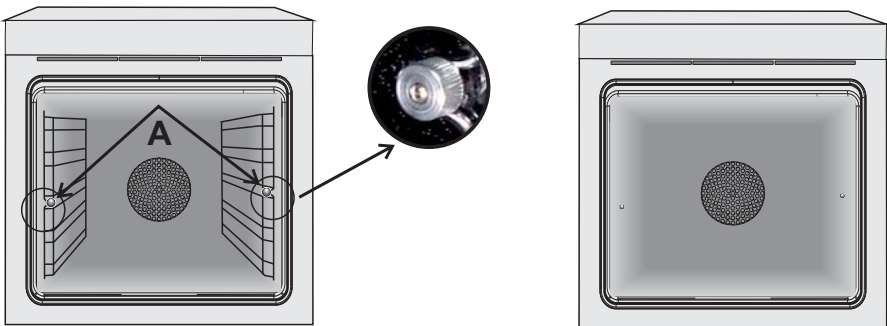

#### **REMOVAL OF THE OVEN WINDOW**

1. Open the front window.
2. Open the clamps of the hinge housing on the right and left side of the front window by pushing them downwards.
3. Replace the window by carrying out the procedure in reverse.

## REMOVAL AND CLEANING OF THE GLASS DOOR

1. Open the oven door.

2.3.4. Lock the hinges, remove the screws and remove the upper metal cover by pulling it upwards.

5.6. Remove the glass, carefully extracting it from the oven door (NB: in pyrolytic ovens, also remove the second and third glass (if present)).

7. At the end of cleaning or substitution, reassemble the parts in reverse order.

On all glass, the indication "Pyro" must be legible and positioned on the left side of the door, close to the left-hand lateral hinge. In this way, the printed label of the first glass will be inside the door.

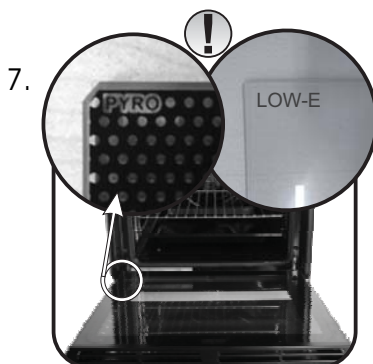
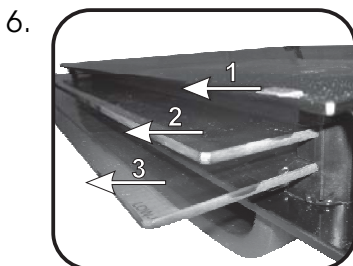
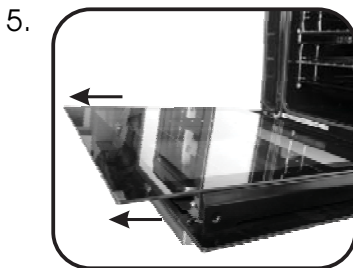
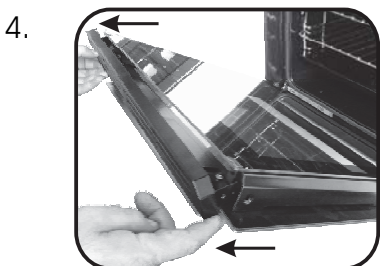
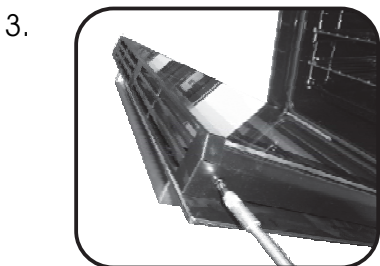
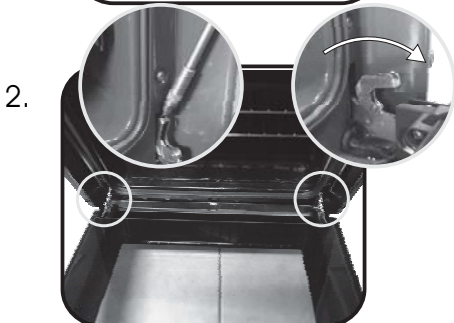

## CHANGING THE BULB

1. Disconnect the oven from the mains supply.
2. Undo the glass cover, unscrew the bulb and replace it with a new bulb of the same type.
3. Once the defective bulb is replaced, replace the glass cover.



## 5. Troubleshooting

---

### 5.1 FAQ

---

PROBLEM	POSSIBLE CAUSE	SOLUTION
The oven does not heat up	The clock is not set	Set the clock
The oven does not heat up	The child lock is on	Deactivate the child lock
The oven does not heat up	A cooking function and temperature has not been set	Ensure that the necessary settings are correct
No reaction of the touch user interface	Steam and condensation on the user interface panel	Clean with a microfiber cloth the user interface panel to remove the condensation layer

<b>INSTALLATION</b>	<b>EN</b>
<b>INSTALLATION DU FOUR</b>	<b>FR</b>
<b>INSTALLAZIONE</b>	<b>IT</b>
<b>INSTALACIÓN</b>	<b>ES</b>

<b>INSTALLATION</b>	<b>DE</b>
<b>KURULUM</b>	<b>TR</b>
<b>INSTALACE</b>	<b>CZ</b>
<b>VGRADNJA PEČICE</b>	<b>SL</b>
<b>INŠTALÁCIA</b>	<b>SK</b>

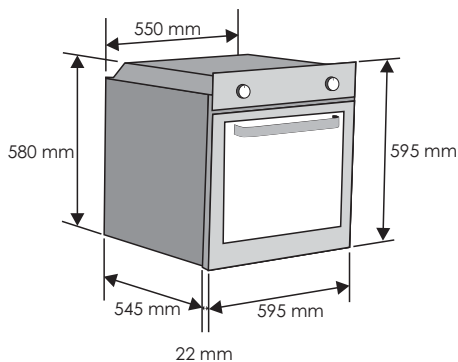
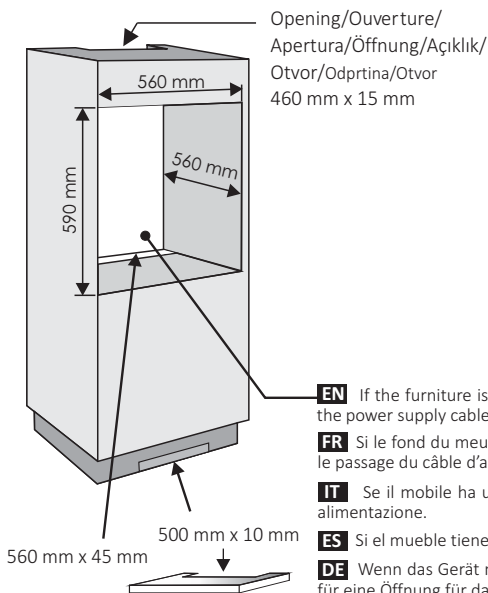

**EN** If the furniture is coverage with a bottom at the back part, provide an opening for the power supply cable.

**FR** Si le fond du meuble est doté d'un panneau de fermeture, prévoyez un orifice pour le passage du câble d'alimentation.

**IT** Se il mobile ha un fondo posteriore, praticare un foro per il passaggio del cavo di alimentazione.

**ES** Si el mueble tiene panel posterior, haga un orificio para el cable de alimentación.

**DE** Wenn das Gerät mit einer Abdeckung auf der Rückseite ausgestattet ist, sorgen Sie für eine Öffnung für das Stromversorgungskabel.

**TR** Mobilyanın arka tarafında bir kaplama bulunuyorsa güç kaynağı kablolu için bir delik açın.

**CZ** Je-li nábytek v zadní části vybaven krytem, vytvořte otvor pro napájecí kabel.

**SL** Če je na omarici tudi hrbtna stran, morate v njej narediti odprtino za napajalni kabel.

**SK** Ak je nábytok vybavený zo zadnej časti krytom, zabezpečte otvor pre prívodný elektrický kábel.

**EN** If the oven does not have a cooling fan, create an opening 460 mm x 15 mm

**FR** Si le four n'a pas de ventilateur de refroidissement, créer une ouverture 460 mm x 15 mm

**IT** Se il forno non dispone di una ventola di raffreddamento, lasciare uno spazio 460 mm x 15 mm

**ES** Si el horno no tiene ventilador de refrigeración, practique una abertura. 460 mm x 15 mm

**DE** Schaffen Sie eine Öffnung, wenn der Ofen über keinen Lüfter verfügt 460 mm x 15 mm

**TR** Fırında soğutma fanı yoksa bir açıklık oluşturun 460 mm x 15 mm

**CZ** Pokud nemá trouba chladičí ventilátor, vytvořte otvor. 460 mm x 15 mm

**SL** Če pečica nima hladilnega ventilatorja, napravite ustrezno odprtino 460 mm x 15 mm

**SK** Ak na rúre nie je chladiaci ventilátor, vytvorte otvor 460 mm x 15 mm

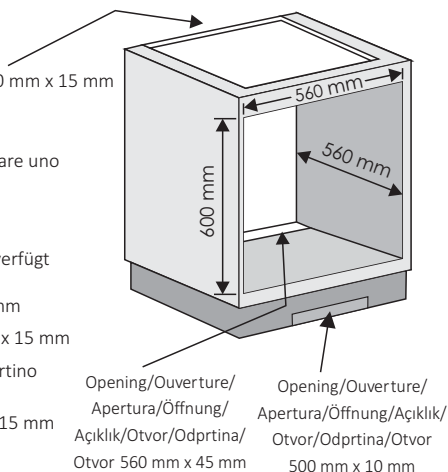



## EN

The manufacturer will not be responsible for any inaccuracy resulting from printing or transcript errors contained in this brochure. We reserve the right to carry out modifications to products as required, including the interests of consumption, without prejudice to the characteristics relating to safety or function.

## FR

Le constructeur décline toute responsabilité concernant d'éventuelles Inexactitudes Imputables à des erreurs d'impression ou de transcription contenue dans cette notice. Le constructeur se réserve le droit de modifier les produits en cas de nécessité, même dans l'intérêt de l'utilisation, sans causer de préjudices aux caractéristiques de fonctionnement de sécurité des appareils.

## IT

Il produttore declina ogni responsabilità per inesattezze contenute nel documento stampato o per errori di trascrizione contenuti in questa brochure. Inoltre, si riserva il diritto di apportare modifiche al prodotto, nell'interesse dei consumatori, senza alcun pregiudizio per la sua sicurezza o funzionalità.

## ES

El fabricante no se responsabiliza de las inexactitudes debidas a fallos de impresión o transcripción contenidos en este folleto. Nos reservamos el derecho a modificar los productos como sea necesario, incluidos los intereses de consumo, sin perjuicio de las características relacionadas con la seguridad o su funcionamiento.

## DE

Der Hersteller übernimmt keine Haftung für eventuelle Druck- oder Übersetzungsfehler dieser Bedienungsanleitung. Der Hersteller behält sich vor technische Änderungen zur Verbesserung der Produktqualität im Interesse des Endverbrauchers vorzunehmen.

## TR

Üretici bu kullanma kılavuzunda bulunan basım veya kopyalama hatalarından kaynaklanan herhangi bir yanlışlıktan sorumlu olmayacaktır. Güvenlik veya işlevle ilgili özelliklere zarar vermeden tüketim istekleri dahil olmak üzere ürünlerde gerektiğinde değişiklik yapma hakkımız mahfuzdur.

## CZ

Výrobce neodpovídá za tiskové chyby v návodu. Vyhradzujeme si právo na změny spotřebiče podle potřeby, včetně údajů spotřeby, bez vlivu na bezpečnost nebo funkci.

## SL

Proizvajalec ne prevzema odgovornosti za morebitne tiskarske napake v tej knjižici. Pridržuje si pravico do sprememb na aparatu brez predhodnega obvestila vključno s porabo, ki ne vplivajo na varnost ali delovanje pečice.

## SK

Výrobca nezodpovedá za žiadne nepresnosti obsiahnuté v tejto brožúre spôsobené chybami tlače alebo prepisu. Vyhradzujeme si právo vykonať zmeny na výrobkoch podľa potreby, vrátane zlepšení v záujme spotreby bez toho, aby došlo k negatívnemu ovplyvneniu bezpečnostných alebo funkčných charakteristík spotrebiča.