

# Safety Information

## Important Safety Information

### SAVE THESE INSTRUCTIONS

**⚠ WARNING:** When using an electrical appliance, basic precautions should always be followed, including the following:

### READ ALL INSTRUCTIONS

**⚠ WARNING:** To reduce the risk of injury or damage, read and follow the safety precautions when setting up, using, and maintaining your robot.

This appliance may only be used by children aged 8 years and above and persons with reduced physical, sensory, or mental capabilities or lack of experience and knowledge if they have been given supervision or instruction concerning use of the appliance in a safe way and understand the hazards involved. Children must not play with the appliance. Cleaning and user maintenance must not be carried out by children without supervision.

**⚠** This is the safety alert symbol. It is used to alert you to potential physical injury hazards. Obey all safety messages that follow this symbol to avoid possible injury or death.

**⚡** Risk of electric shock



Class II equipment



Rated power output, d.c.



Read owner's manual



General symbol for recycling

**🔥** Risk of fire



For indoor use only



Rated power input, d.c.



Keep out of reach of children



**BFP** Backfeed Protection

**⏏** Separate Supply Unit



Indicates output polarity



Rated power input, a.c.

**WARNING:** Indicates a hazardous situation that, if not avoided, could result in death or serious injury.

**CAUTION:** Indicates a hazardous situation that, if not avoided, could result in minor or moderate injury.

**NOTICE:** Indicates a hazardous situation that, if not avoided, could result in property damage.

### GENERAL



## WARNING

- Your robot is not a toy. Small children and pets should be supervised when your robot is operating.
- Do not sit or stand on your robot or Home Base charging station.
- Do not use unauthorised chargers. Use of an unauthorised charger could cause the battery to generate heat, smoke, catch fire, or explode.
- Your robot comes with a region approved power supply cord and is designed to be plugged into a standard household AC power outlet only. Do not use any other power supply cord. For replacement cords, please contact Customer Care to ensure proper selection of country specific power supply cord.
- Do not open your robot or the Home Base charging station. There are no user serviceable parts inside. Refer servicing to qualified service personnel.
- Risk of electric shock, use indoors in dry locations only.
- Do not handle your robot and Home Base with wet hands.
- Store and operate your robot in room temperature environments only.
- If the room to be cleaned contains a balcony, a physical barrier should be used to prevent access to the balcony and ensure safe operation.



## CAUTION

- Be aware that the robot moves on its own. Take care when walking in the area that the robot is operating in to avoid stepping on it.
- Do not operate the robot in areas with exposed electrical outlets in the floor.
- Do not use this device to pick up sharp objects, glass, or anything that is burning or smoking.
- If the device passes over a power cord and drags it, there is a chance an object could be pulled off a table or shelf. Before using this device, pick up objects like clothing, loose papers, pull cords for blinds or curtains, power cords, and any fragile objects.

## NOTICE

- This robot is intended for dry floor use only. Do not use this device to pick up spills. Do not allow your robot or Home Base charging station to become wet.
- Do not place anything on top of your robot.
- The failure to maintain the cleanliness of charger contacts could result in loss of ability for the robot to charge the battery.

### HOME BASE™ CHARGING STATION



## WARNING

- Do not use a Home Base with a damaged cord or plug. If the cord or plug is damaged, it must be replaced.
- Always disconnect your robot from the Home Base before cleaning or maintaining it.

- Only use the included battery charger to charge the iRobot ABL-D1 battery. Other types of batteries may burst, causing injury. Always contact Customer Care for the correct replacement of your battery. Battery Charger model 17070: Input AC 100–240 V, 50–60 Hz, 0.68 A; 33 W. Output DC 20.5 V, 1.25 A.
- To prevent the risk of your robot falling down stairs, ensure that the Home Base Charging Station is placed at least 4 feet (1.2 metres) away from stairs.

## NOTICE

- The product may not be used with any type of power converter. Use of power converters will immediately void the warranty.
- If you live in an area prone to electrical storms, it is recommended that you use additional surge protection. Your robot's Home Base may be protected with a surge protector in the event of severe electrical storms.

### BATTERY



## WARNING



- Do not open, crush, heat above 176° F: 80° C, or incinerate. Follow manufacturer's instructions.
- Do not short-circuit the battery by allowing metal objects to come into contact with the battery terminals, or immerse in liquid. Do not subject batteries to mechanical shock.
- Periodically inspect the battery pack for any sign of damage or leakage. Immediately stop using the battery if there are noticeable abnormalities, such as smell, heat, discolouration, or deformity. Do not charge damaged or leaking battery packs; do not allow the liquid to come into contact with skin or eyes. If

contact has been made, wash the affected area with copious amounts of water and seek medical advice. Place the battery in a sealed plastic bag and dispose of it safely according to local environmental regulations. Return it to your local authorised iRobot Service Centre for disposal.

- Lithium ion batteries and products that contain lithium ion batteries are subject to stringent transportation regulations. If you need to ship this product (with the battery included) for service, travel, or any other reason, you **MUST** see the Troubleshooting section of your manual or contact Customer Care for shipping instructions.



## CAUTION



- Battery usage by children should be supervised. Seek medical advice immediately if a cell or battery has been swallowed.

## NOTICE

- The battery pack must be removed from the robot before disposal.
- For best results, only use the iRobot lithium ion battery that comes with the robot.
- Do not use non-rechargeable batteries. Use only the rechargeable battery supplied with the product. For replacement, purchase an identical iRobot battery or contact iRobot Customer Care for alternative battery options.
- Batteries must be disposed of in accordance with local regulations.
- Always charge and remove the battery from your robot and accessories before long-term storage.

# About your Roomba® Robot Vacuum

EN

## Top View

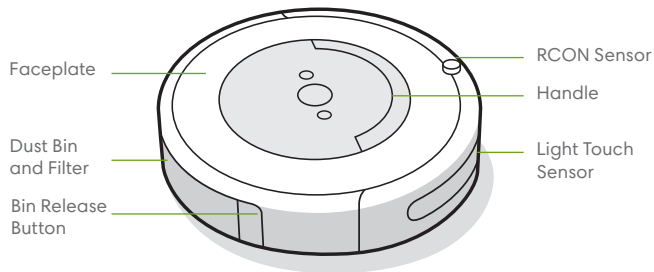

## Home Base

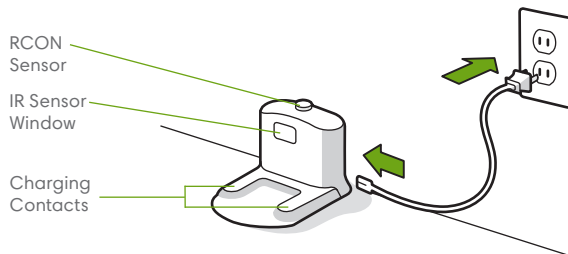

## Bottom View

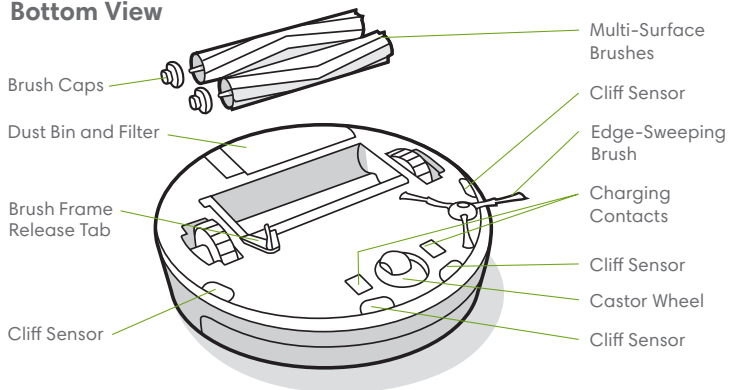

## Buttons & Indicators

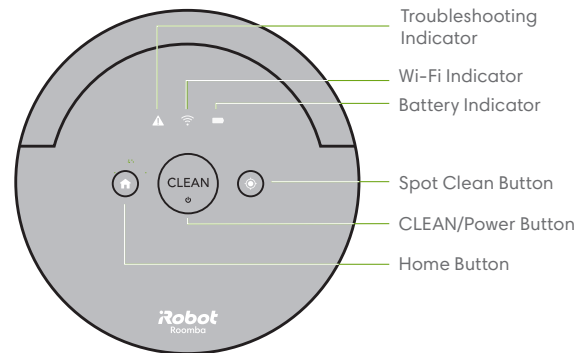

# Using Your Roomba® Robot Vacuum

## Set up the Home Base™ charging station

**⚠ WARNING:** To prevent the risk of your robot falling down stairs, ensure that the Home Base Charging Station is placed at least 4 feet (1.2 metres) away from stairs.

Place the Home Base in an open, uncluttered area, leaving the following distances around the Home Base:

- At least 1.5 feet (0.5 metres) on each side of the Home Base
- At least 4 feet (1.2 metres) in front of the Home Base and at least 4 feet (1.2 metres) away from stairs
- At least 8 feet (2.5 metres) from Virtual Wall Barriers
- Always keep the Home Base plugged in and make sure it is in an area with consistent Wi-Fi® coverage to allow the Roomba® robot vacuum to receive information via the iRobot HOME App.

## Download the iRobot HOME App and connect to Wi-Fi®

- Watch an overview video with instructions on how to set up and use your Roomba® robot vacuum
- Set an automatic cleaning schedule and customise cleaning preferences
- Enable automatic software updates
- Access tips, tricks, and answers to commonly asked questions including how to pair your Roomba® robot vacuum with other smart devices.



## Get to know your robot

- Place the robot on the Home Base to activate the battery

**📄 Note:** Your robot comes with a partial charge, but we recommend that you charge the robot on the Home Base for 3 hours prior to starting the first complete cleaning cycle.



**📄 Note:** Remove excess clutter from floors before cleaning (e.g. clothing, toys, etc.). Use your Roomba® robot vacuum frequently to maintain well-conditioned floors.

If the robot is returning to recharge after completing a cleaning cycle, it will play a series of tones to indicate successful completion of the job.

- To pause the robot during a cleaning cycle, press CLEAN.
- To resume the cleaning cycle, press CLEAN again.
- To send the robot back to its Home Base during a cleaning cycle, press CLEAN and then  (Home) button on the robot or press CLEAN on the iRobot HOME App main screen. This will end the cleaning cycle.

**📄 Note:** When the robot is returning to the Home Base, the  (Home) button will blink.

- The robot will automatically engage Dirt Detect™ mode when it encounters a high concentration of dirt or debris. The robot will move in a spiral motion to clean the area more thoroughly. The CLEAN button will pulse when the robot engages Dirt Detect™ mode. When finished, the robot will continue its cleaning job.

- You can use the Spot Clean feature to make the robot target specific spills. Just place the robot in the centre of the debris and press  (Spot Clean). The robot will clean the area by spiralling outwards about 3 feet (1 metre) and then spiral inwards to end where it started.
- Keep the robot on the Home Base™ charging station so it's always ready to clean when you need it. If you need to store the robot off the charging station, turn off the battery by removing the robot from the Home Base charging station and holding down the  (Home) button for 9 seconds. All indicators will turn off and you will hear an audible tone. You can then store the robot in a cool, dry place. To wake the robot up and turn on the battery, plug in the Home Base charging station and place the robot on the charging station.
- When the robot is charging, it will turn off the indicator lights to save energy. You can check the status by pressing the CLEAN button. The Battery Indicator icon will illuminate amber when the battery is charging and green when the battery is fully charged. Battery charge status can also be viewed in the iRobot HOME App.

 **Note:** After each use, empty the bin and clean the filter.

## Accessories

### Dual Mode Virtual Wall® Barrier (compatible with all models)

Use the Dual Mode Virtual Wall® barrier to keep the robot in the places you want cleaned – and out of the ones you don't. It creates an invisible barrier that only the robot can see. You can leave the device in position between cleanings.

#### Choose the mode to meet your needs:

**Virtual Wall Mode:** When the switch is in the Virtual Wall position () the device will create a linear barrier to block openings up to 10 feet (3 metres).

 **Note:** This barrier gets wider as it gets further from the device (refer to illustration).

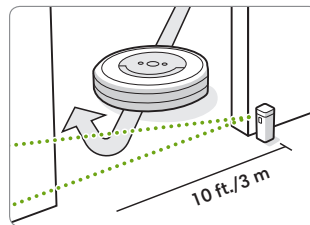
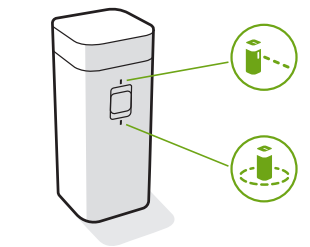

**Halo Mode:** Toggle the switch to the Halo position () to create a circular barrier. This will prevent the robot from approaching zones you want to protect such as a pet bowl, vase, or under a desk. The Halo barrier extends approximately 24 inches (60 centimetres) from the centre of the device.

 **Note:** The batteries will last about 8-10 months under normal use. If you are not planning to use your Virtual Wall barrier for an extended period of time, be sure to turn the switch to the Off or middle position.

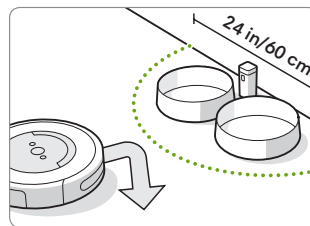

# Care and Maintenance

## Care and Maintenance Instructions

To keep your Roomba® robot vacuum running at peak performance, perform the procedures on the following pages.

There are additional instructional videos in the iRobot HOME App. If you notice the robot picking up less debris from your floor, empty the bin, clean the filter, and clean the brushes.

## Care and Maintenance Overview

Part	Care	Replace*	Details
Bin	Empty after each use		Page 3
Filter	Clean every week (twice a week if you have a pet)	Every 2 months	Page 3
Front Castor Wheel	Clean every 2 weeks	Every 12 months	Page 4
Edge-Sweeping Brush and Multi-Surface Brushes	Clean every month (twice a month if you have a pet)	Every 12 months	Page 4-5
Sensors and Charging Contacts	Clean once a month		Page 5

**Note:** iRobot manufactures various replacement parts and assemblies. If you think you need a replacement part, please contact iRobot Customer Care for more information. Ask Customer Care or visit an authorised iRobot® dealer.

\*Replacement frequency may vary. Parts should be replaced if visible wear appears.

## Emptying the Bin

- 1 Press the bin release button to remove the bin.



- 2 Open the bin door to empty the bin.

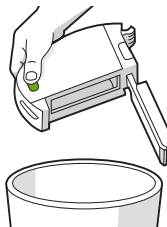

- 3 Place the bin back into the robot.

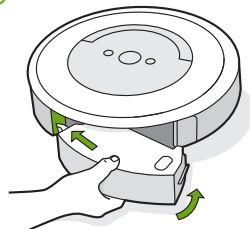

## Cleaning the Filter

- 1 Release the bin. Remove the filter by grasping both ends and pulling out.

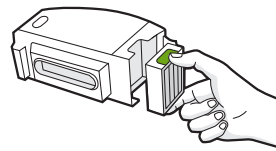

- 2 Shake off debris by tapping the filter against your household rubbish bin.



- 3 Reinsert the filter with the ridged grips facing out. Place the bin back into the robot.

**\* Important:** The robot will not run if the filter is not installed correctly. Replace the filter every two months.

EN

## Washing the Bin

**\* Important:** Do not wash the filter. Remove the filter before washing the bin.

- 1 Release the bin, remove the filter, and open the bin door.
- 2 Rinse the bin using warm water.

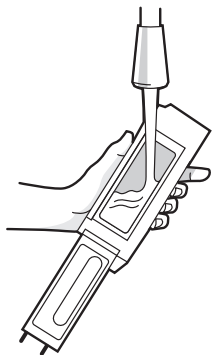

- 3 Make sure that the bin is completely dry. Reinsert the filter and place the bin back into the robot.

**Note:** The bin is not dishwasher safe.

## Cleaning the Front Castor Wheel

- 1 Pull firmly on the front wheel to remove it.
- 2 Remove any debris from inside the wheel cavity.
- 3 Reinstall all parts when finished. Make sure the wheel clicks back into place.

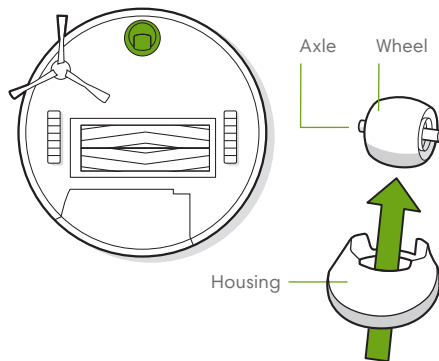

**\* Important:** A front wheel clogged with hair and debris could result in damage to your floor. If the wheel is not spinning freely after you have cleaned it, please contact Customer Care.

## Cleaning the Edge-Sweeping Brush

- 1 Use a coin or small screwdriver to remove the screw holding the Edge-Sweeping Brush in place.
- 2 Remove the Edge-Sweeping Brush, clean the brush and the brush post, and then reinstall the brush.

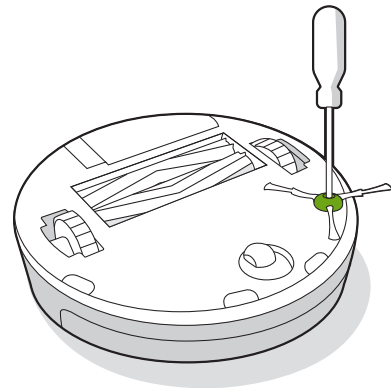



## Cleaning the Multi-Surface Brushes

1 Pinch the brush frame release tab, lift the tab, and remove any obstructions.

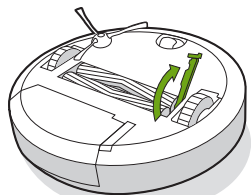

2 Remove the brushes from the robot. Remove the brush caps from the ends of the brushes. Remove any hair or debris that has collected beneath the caps. Reinstall the brush caps.

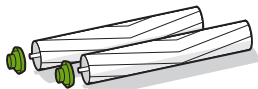

3 Remove any hair or debris from the square and hexagonal pegs on the opposite side of the brushes.

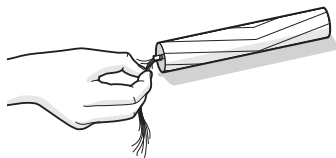

4 Remove the bin from the robot and clear any debris from the vacuum path.

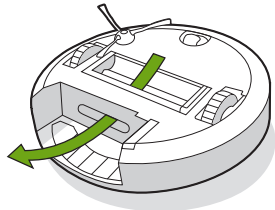

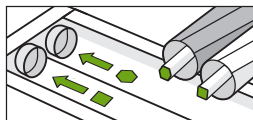

5 Reinstall the brushes in the robot. Match the shape of the brush pegs with the shape of the brush icons in the cleaning head module.

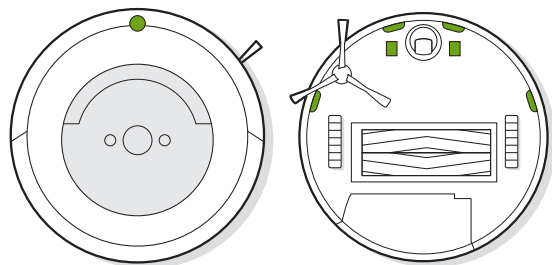

## Cleaning the Sensors and Charging Contacts

1 Wipe sensors and charging contacts with a clean, dry cloth.



 **Important:** Do not spray cleaning solution or water onto the sensors or sensor openings.



# Troubleshooting

EN

Your Roomba® robot vacuum will tell you something is wrong with a two-tone alert, a spoken message, and a blinking troubleshooting indicator (⚠️). Follow the audible instructions. More detailed support and videos are available in the iRobot HOME App and at [global.irobot.com](https://global.irobot.com).

To reboot your robot, press and hold the 🏠 (Home) and ⚡ (Spot Clean) buttons for 10 seconds until all indicators turn off, then release. When you release the buttons, you will hear a tone to confirm a successful reboot.

 **Note:** If you use the scheduling feature, open the iRobot HOME App after rebooting to confirm that the robot's schedule remains intact.

## Reduced Power Standby Mode

The Roomba® robot vacuum uses a small amount of power whenever it is on the Home Base™ charging station. This ensures that the robot is always ready for the next cleaning job and maintains Wi-Fi® connectivity. You can put the robot in a further-reduced power state when not in use. For instructions and more details on this Reduced Power Standby Mode, refer to the iRobot HOME App.

## Lithium Ion Battery

For best results, only use the iRobot lithium ion battery that comes with your Roomba® robot vacuum.

 **WARNING:** Lithium ion batteries and products that contain lithium ion batteries are subject to stringent transportation regulations. If you need to ship this product (with the battery included) for service, travel, or any other reason, you **MUST** follow the shipping instructions below.

- The battery **MUST** be turned off before shipping.
- Remove the robot from the Home Base Charging Station.
- Ensure that the CLEAN button is illuminated by pressing the CLEAN button once quickly.
- Once the button is illuminated, press and hold the CLEAN button for 12 seconds. You will hear an audible tone.
- Once you hear the tone, release the CLEAN button. The battery is now turned off.
- Package the product in its original packaging.
- Ship via ground transportation only (no air shipping).
- If you need further assistance, contact our Customer Care team.

# iRobot Customer Care

## USA & Canada

If you have questions or comments about your Roomba® robot vacuum, please contact iRobot before contacting a retailer.

You can start by visiting [global.irobot.com](https://global.irobot.com) for support tips, frequently asked questions, and information about accessories. This information can also be found in the iRobot HOME App. If you need further assistance, call our Customer Care team on **(877) 855-8593**.

## iRobot Customer Care Hours

- Monday to Friday, 9AM – 9PM Eastern Time
- Saturday and Sunday 9AM – 6PM Eastern Time

## Outside USA & Canada

Visit [global.irobot.com](https://global.irobot.com) to:

- Learn more about iRobot in your country.
- Get hints and tips to improve your Roomba® robot vacuum's performance.
- Get answers to questions.
- Contact your local support centre.

# Regulatory Information

iRobot Corporation hereby declares that the radio equipment type Roomba is in compliance with Directive 2014/53/EU. The full text of the EU Declaration of Conformity is available at the following internet address: [www.irobot.com/compliance](http://www.irobot.com/compliance). The Azurewave model: AW-CU300 radio operates in the ISM band between 2412-2472 MHz with a maximum EIRP output power of 19.78 dBm (95.1 mW) at 2412 MHz. Products marked with this symbol cannot be disposed of as unsorted municipal waste in the European Union. For proper recycling, return this product to your local supplier upon the purchase of equivalent new equipment, or dispose of it at a designated collection point. This product contains a battery that cannot be disposed of as unsorted municipal waste in the European Union. For proper recycling, return the battery to your supplier or to a designated collection point. Refer to the website [www.irobot.com/compliance](http://www.irobot.com/compliance) for restricted substance declarations. Use the battery only with iRobot products at room temperature (50-104° F) (10 to 40° C).



©2018 iRobot Corporation, 8 Crosby Drive, Bedford, MA 01730 USA. All rights reserved. iRobot, Roomba, iAdapt, Home Base and Virtual Wall are registered trademarks of iRobot Corporation. Dirt Detect is a trademark of iRobot Corporation. App Store is a trademark of Apple, Inc., registered in the U.S. and other countries. Google Play is a trademark of Google, Inc.