

Operating Instructions

60cm Gas Cooker

GB

GB

English, 1

HUG61P
HUG61K
HUG61G
HUG61X
HUL61P
HUL61K
HUL61G
HUL61X
HAG60S
HAG60K
HAG60X
62DGW
62DGG
60HGP
DSG60S
HAG60G
HAG60P

Contents

Introduction, 2
For Your Safety, 3
Installation Instructions, 4-7
Electrical Connection, 8
Installation, 9
Features, 10
Control Panel, 11
Clock/ Minute Minder Operation, 12
Hotplates, 13
Grill, 14
Main Oven, 15
Main Oven Cooking Charts, 16-17
Slow Cooking, 18
Top Oven, 19
Top Oven Cooking Charts, 20-21
Care and Cleaning, 22-24
Something Wrong with your cooker? 25
Disposal of the appliance, 26
Guarantee Information, 27
Service Information, 28

 **Hotpoint**

Please phone us on
08448 24 24 24
to activate your
guarantee

Introduction

GB

To the Installer:

Before installation, fill in the product details on the back cover of this book.

The information can be found on the rating plate.

To the User:

You must read the instructions prior to installing and using the appliance and then retain them for future reference.

! Before operating your new appliance please read this instruction booklet carefully. It contains important information concerning the safe operation, installation and maintenance of the appliance.

! Please keep these operating instructions for future reference. Pass them on to possible new owners of the appliance.

Retention of this Instruction Book

This Instruction Book must be kept handy for reference as it contains important details on the safe and proper use of the appliance.

If you sell or pass the appliance to someone else, or move house and leave it behind, make sure this Book is also provided so the new owner can become familiar with the appliance and safety warnings.

Your new appliance is guaranteed* and will give lasting service. This guarantee is only applicable if the appliance has been installed in accordance with the installation instructions detailed in this booklet.

To help make best use of your cooking equipment, please read this booklet carefully.

The cooker is designed specifically for domestic use and responsibility will not be accepted for use in any other installation.

When the cooker is first used an odour may be emitted, this will cease after a period of use.

When first using the cooker ensure that the room is well ventilated (e.g. open a window or use an extractor fan) and that persons who may be sensitive to the odour avoid any fumes.

It is suggested that any pets be removed from the room until the smell has ceased. This odour is due to temporary finish on oven liners and elements and also any moisture absorbed by the insulation.

Your new cooker is guaranteed and will give lasting service.

The guarantee is only applicable if the cooker has been installed in accordance with the Installation Instructions.

The cooker is designed specifically for domestic use and responsibility will not be accepted for use in any other installation.

* The guarantee is subject to the provisions that the appliance:

- (a) **Has been used solely in accordance with the Users Instruction Book.**
- (b) **Has been properly connected to a suitable supply voltage as stated on the rating plate attached to this equipment.**
- (c) **Has not been subjected to misuse or accident or been modified or repaired by any person other than the authorised employee or agent.**
- (d) **Has been correctly installed.**

Our policy is one of continual improvement in design and development, therefore strict accuracy of illustrations and descriptions cannot be guaranteed.



This appliance conforms with the following European Economic Community directives:

- 2006/95/EC of 12/12/06 (Low Voltage) and subsequent modifications;
- 2004/108/EC of 15/12/04 (Electromagnetic Compatibility) and subsequent modifications;
- 2009/142/EC of 30/11/09 (Gas) and subsequent modifications (only for models which use gas);
- 93/68/EEC of 22/07/93 and subsequent modifications.
- 2002/96/EC
- 1275/2008 (Stand-by/ Off Mode)

Please read the precautions below before using your cooker.

ALWAYS . . .

- ALWAYS make sure you understand the controls before using the cooker.
- ALWAYS check that all controls on the cooker are turned off after use.
- ALWAYS stand back when opening an oven door to allow heat to disperse.
- ALWAYS use dry, good quality oven gloves when removing items from the ovens.
- ALWAYS take care when removing items from the top oven/grill when the main oven is on, as the contents may be hot.
- ALWAYS keep the oven and grill doors closed when the cooker is not in use.
- ALWAYS place pans centrally over the hotplate burners and position them so that the handles cannot accidentally be caught or knocked or become heated by other burners.
- ALWAYS keep the cooker clean, as a build up of grease or fat from cooking can cause a fire.
- ALWAYS allow the cooker to cool before cleaning.
- ALWAYS follow the basic principles of food handling and hygiene to prevent the possibility of bacterial growth.
- ALWAYS keep ventilation slots clear of obstructions.
- ALWAYS turn off the electricity supply before cleaning or replacing an oven lamp.
- ALWAYS refer servicing to CORGI registered appliance service engineers.

NEVER . . .

- ALWAYS The appliance must be used by adults only for the preparation of food, in accordance with the instructions outlined in this booklet. Any other use of the appliance (e.g. for heating the room) constitutes improper use and is dangerous. The manufacturer may not be held liable for any damage resulting from improper, incorrect and unreasonable use of the appliance.

- NEVER leave children unsupervised where the cooker is installed as all surfaces will get hot during and after use.
- NEVER allow anyone to sit or stand on any part of the cooker.
- NEVER store items that children may attempt to reach above the cooker.
- NEVER heat up unopened food containers as pressure can build up causing the container to burst.
- NEVER store chemicals, food stuffs, pressurised containers in or on the cooker, or in cabinets immediately above or next to the cooker.
- NEVER fill a deep fat frying pan more than 1/3 full of oil, and never use a lid. **DO NOT LEAVE UNATTENDED WHILE COOKING.**
- NEVER place flammable or plastic items on or near the hotplate.
- NEVER use proprietary spillage collectors on the hotplate.
- NEVER use the cooker as a room heater.
- NEVER dry clothes or place other times over or near to the hotplate or oven/grill doors.
- NEVER wear garments with long flowing sleeves whilst cooking.
- NEVER let children play with the appliance.
- NEVER should the appliance be operated by people (including children) with reduced physical, sensory or mental capacities, by inexperienced individuals or by anyone who is not familiar with the product. These individuals should, at the very least, be supervised by someone who assumes responsibility for their safety or receive preliminary instructions relating to the operation of the appliance.
- NEVER should the appliance be operated by people (including children) with reduced physical, sensory or mental capacities, by inexperienced individuals or by anyone who is not familiar with the product. These individuals should, at the very least, be supervised by someone who assumes responsibility for their safety or receive preliminary instructions relating to the operation of the appliance.

NOTE: The use of a gas cooking appliance results in the production of heat and moisture in the room in which it is installed. Always ensure that the kitchen is well ventilated; keep natural ventilation holes open or install a mechanical ventilation device (mechanical extractor hood).

NOTICE

! VERY HOT SURFACES

FOOD OR GREASE ON THESE SURFACES COULD CAUSE SMOKE AND POSSIBLY EVEN BURN

YOU MUST KEEP THE OVEN AND GRILL CAVITIES CLEAN

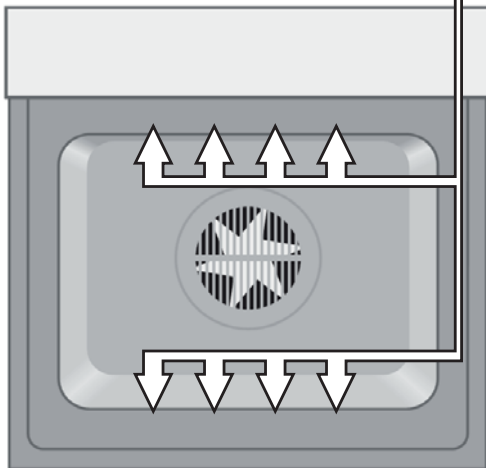

! ATTENTION

DURING INSTALLATION THE FEET OF THE APPLIANCE MUST BE LOWERED SO THAT AN AIR GAP OF AT LEAST 10MM (1CM) IS LEFT BETWEEN THE BASE OF THE APPLIANCE AND THE FLOOR.



! ATTENTION

WHEN USING THE MAIN OVEN YOU MUST ENSURE THAT THE BASE OF THE CAVITY IS NOT COVERED WITH ALUMINUM FOIL, UTENSIL OR ANY OTHER FORM OF COVERING. FAILURE TO DO THIS MAY RESULT IN THE CAVITY BEING DAMAGED.

Prior to installation, ensure that the local distribution conditions (nature of the gas and gas pressure) and the adjustment conditions are compatible. The adjustment conditions for this appliance are stated on the data badge which is fitted on the back panel. This appliance is not designed to be connected to a combustion products evacuation device. It must be installed and connected in accordance with current installation regulations. Particular attention should be given to the relevant requirements regarding ventilation.

MODEL NUMBERS

HUG61P, HUG61K, HUG61G, HUG61X, HAG60S, HAG60K, HAG60X, 62DGW, 62DGG, 60HGP, DSG60S, HAG60G, HAG60P

Category II2H3+ (GB)

These models are set to burn NATURAL GAS (G20) at 20 mbar but can be converted for use on BUTANE (G30) at 28-30mbar with the use of the LPG conversion kit that can be obtained free of charge, if you contact our Genuine Parts and Accessories department (see Key Contacts, back page).

GAS SAFETY (INSTALLATION & USE) REGULATIONS

It is the law that all gas appliances are installed by competent persons in accordance with the current edition of the above regulations. It is in your interest and that of safety to ensure compliance with the law. In the UK, CORGI registered installers work to safe standards of practice. The cooker must also be installed in accordance with BS 6172. Failure to install the cooker correctly could invalidate the warranty liability claims and could lead to prosecution.

Adapting to different types of gas (main and top oven)

In order to adapt the oven to a different type of gas with respect to the gas for which it was manufactured (indicated on the label), follow these simple steps:

- a) Replacing the oven burner nozzle
- open the oven door fully
 - pull out the sliding oven bottom
 - **unscrew the two screws and take off the shield protecting the burner (in main oven burner only).**

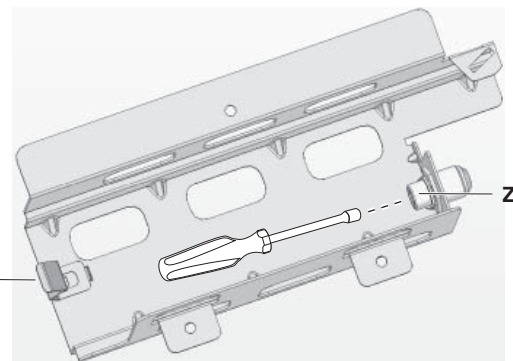
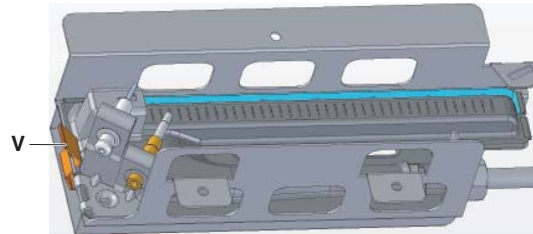

- Pry the fixing tab "V" and remove the oven burner
- Unscrew the oven burner nozzle using the socket spanner for the nozzles "Z", or a 7 mm socket spanner, and replace it with a nozzle suited to the new type of gas (see Table). Take particular care handling the spark plug wires and the thermocouple pipes.
- Replace all the parts, following the steps described above in the reverse order.

	G20 at 20mbar		G30 at 28-30mbar G31 at 37mbar	
	Heat Input	Injector	Heat Input	Injector
Hotplate Front Left and Rear Right	3.0 kW	116	3.0 kW (220g/h)	86
Hotplate Front Right and Rear Left	2.0 kW	103	2.0 kW (145g/h)	70
Grill	3.7 kW	150 (X)	3.4 kW (246g/h)	91
Main Oven	2.5 kW	115	2.3 kW (166g/h)	71
Top Oven	1.9 kW	100	1.9 kW (136g/h)	66

Installation

GB

LOCATION

The cooker may be located in a kitchen, kitchen/diner or a bed-sitting room, but not in a room containing a bath or shower. The cooker must not be installed in a bed-sitting room of less than 20m³.

When adjusted for use on Butane (G30) or Propane (G31), the cooker must not be installed in a room or internal space below ground level, e.g. in a basement.

PROVISION FOR VENTILATION

The room containing the cooker should have an air supply in accordance with BS 5440: Part 2.

The room must have an opening window or equivalent; some rooms may also require a permanent vent. If the room has a volume between 5 and 10m³, it will require an air vent of 50cm² effective area unless it has a door which opens directly to outside. If the room has a volume of less than 5m³, it will require an air vent of 100cm² effective area. If there are other fuel burning appliances in the same room, BS 5440: Part 2 should be consulted to determine air vent requirements.

TECHNICAL DATA

Gas connection	Rp ½ (½" BSP female)
Pressure test point injector	Front left hotplate
Gas rate adjustment	None
Aeration adjustment	None
Electrical connection	Flexible cord fitted with a 3 pin 13 amp plug 230/240V a.c. 50Hz. 13A fuse.

- The cooker may be located in a kitchen, a kitchen/diner or bed sitting room, but not in a bathroom or shower room.
- The hoods must be installed according to the requirements in the hood handbook.
- The wall in contact with the back of the cooker must be of flameproof material.
- The cooker is fitted with a safety chain that must be attached to a hook, secured to the wall behind the appliance.



!Some models can have their gas connection inverted. It is important to make sure the safety chain is always situated on the side which corresponds to the hose holder (Fig. B).

SPACE FOR FIXING

The cooker can be close fitted below hotplate level. This requires a minimum distance of 600mm between cupboard units of hotplate height.

When installing next to a tall cupboard, partition or wall, for a minimum distance of 400mm above hotplate level, allow a side clearance of at least 65mm. The diagram below illustrates the minimum clearance between the cooker and adjacent walls, cupboards etc.

The wall behind the cooker, 50mm below and 450mm above, and the width of the cooker, must be a non-combustible material such as ceramic wall tiles.

If the cooker is to be fitted close to a corner on the left hand side, ensure that there is a clearance of at least 50mm to allow the main oven door to open fully for when removing oven shelves.

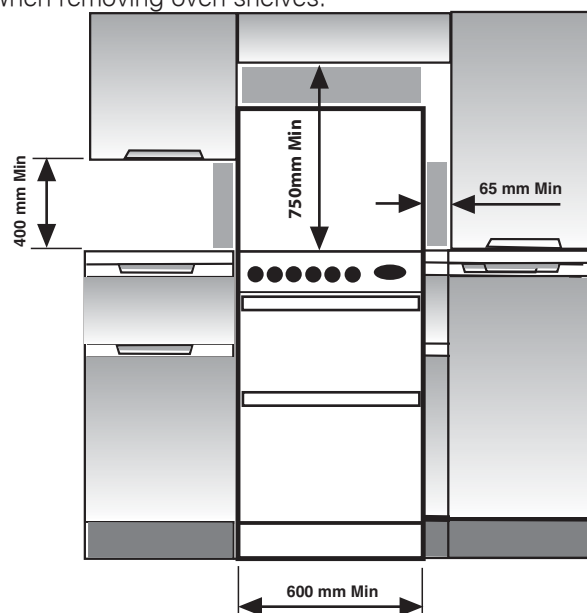

COOKER HOODS

If a cooker hood is to be installed, refer to the cooker hood manufacturers' instructions regarding fixing height.

UNPACKING THE COOKER

Unpack the components from inside the grill and oven. Check that the following parts are present:

Grill pan and grid	Top oven/grill shelf heat shield
Pan supports	Main oven shelves (2)
Enamelled burner caps (4)	Top oven/grill shelf (1)
Aluminium burner bodies(4)	Literature

LEVELLING

Four skid feet are fitted which can be adjusted up or down to level the cooker.

CONVERSION FOR USE ON BUTANE (G30) OR PROPANE (G31)

Each burner requires the injector to be replaced and bypass screws adjusted or replaced as follows:

1. Remove the loose hotplate burner parts.
2. Using a 7mm socket, replace the hotplate injectors as appropriate (see table on previous page).
3. Re-position the loose burner parts.
4. Remove the enamelled baffle at the front of the grill (2 screws).
5. Remove the screw on the right hand side of the burner and gently slide the burner off the injector.
6. Using a 7mm socket, replace the grill injector as appropriate (see table on previous page).
7. Re-assemble the burner and baffle.
8. Inside the top oven, remove the central screw securing the burner retainer. Slide the retainer to the right slightly and lift away.
9. Lift the burner assembly and place on the floor of the oven to the right of the burner opening.
10. Using a 7mm socket, replace the oven injector as appropriate (see table on previous page).
11. Re-assemble the oven burner and retainer.
12. Replace the main oven injector following the same procedure as for the top oven.
13. Carefully pull off the control knobs and timer buttons.
14. Remove the 2 screws securing the underside of the control panel. Slide the control panel to the left slightly to remove.
15. Remove the 6 screws securing the timer mounting panel. Without completely removing it, manoeuvre the timer mounting panel to gain access to the thermostat bypass screws.
16. Using a narrow flat bladed screwdriver rotate the bypass screws fully clockwise. The main oven thermostat bypass screw is located on the body of the thermostat below the spindle, the top oven thermostat bypass screw is located on the body of the thermostat to the right of the spindle and the hotplate tap bypass screws are located down the centre of the spindle.
17. Re-assemble the control panel parts ensuring that when the connections are made to the ignition switch, the wires are above the switch rather than below.
18. Secure the self-adhesive LPG conversion label over the gas details on the data badge.

STABILITY CHAIN

A hole in the gas inlet valve bracket can be used to engage a stability chain.

CONNECTING TO GAS SUPPLY

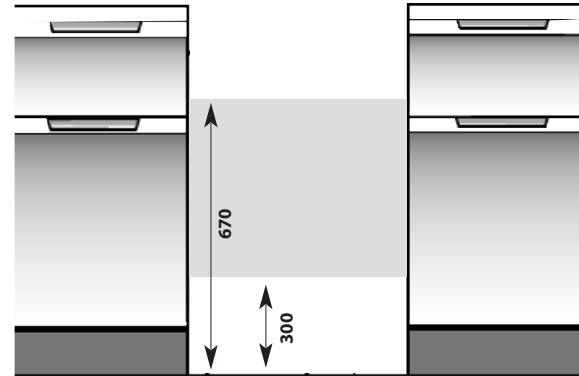

Connection to the cooker should be made with an approved appliance flexible connection to BS 669. A length of 0.9 to 1.25m is recommended. The length of hose chosen should be such that when the cooker is in situ, the hose does not touch the floor.

Those cookers converted to use on LPG should be connected with a hose suitable for LPG and capable of withstanding a pressure of 50 mbar.

An adaptor backplate should be fitted within the shaded area shown, to allow the cooker to be pushed fully to the wall and to ensure that the flexible hose is only likely to come into contact with areas at the rear of the cooker that do not exceed a temperature rise of 70°C.

Electrical Connection

GB

WARNING - THIS APPLIANCE MUST BE EARTHED. CONNECT TO A 230-240V A.C. SUPPLY ONLY.

Connection to the electricity supply should be made via a properly earthed, readily accessible wall socket which is adjacent to but not directly above, and not more than 1.25m away from the appliance and capable of electrical isolation.

The mains lead should be routed such that it cannot touch hot parts of the cooker i.e. the back panel above a height of 650mm from the floor.

Should this plug not fit the socket outlet in your home it should be cut off and replaced with a suitable plug as outlined below.

NOTE: The removed plug cannot be used for any other appliance and should therefore be properly disposed of and not left where children might find it and plug it into a supply socket - with the obvious consequent danger.

IF THE FITTED PLUG IS REMOVED

The flexible mains lead must be correctly connected as below to a three pin plug of not less than 13 amp capacity. If a B.S. 1363 fused plug is used, it must be fitted with a fuse which is approved to B.S. 1362.

IMPORTANT: The wires in the mains lead fitted to this appliance are coloured in accordance with the following code:

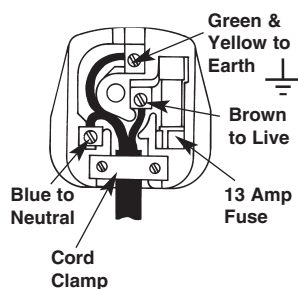

GREEN AND YELLOW - EARTH
BLUE - NEUTRAL
BROWN - LIVE

As the colours of the wires in the mains lead of this appliance may not correspond with the coloured markings identifying the terminals in your plug, proceed as follows:

The wire which is coloured green and yellow must be connected to the terminal in the plug which is marked with the letter E or by the earth symbol  or coloured green or green and yellow.

The wire which is coloured blue must be connected to the terminal which is marked with the N or coloured black.

The wire which is coloured brown must be connected to the terminal which is marked with the letter L or coloured red.

When wiring the plug, ensure that all strands of wire are securely retained in each terminal. Do not forget to tighten the mains lead clamp on the plug.

As the appliance must be earthed, **do not use** 2-pin sockets outlets, **if you are in doubt, consult a qualified electrician.**

Should the mains lead ever require replacement, it is essential that this operation be carried out by a qualified electrician and should only be replaced with a flexible cord of the same size i.e. 1.0mm² cross sectional area PVC cable, available from our parts department (see Back Cover).

IF A MOULDED PLUG IS FITTED

In the event of replacing a fuse in the plug supplied an ASTA approved fuse to BS1362 must be fitted.

NOTE: The fuse cover must be refitted when changing the fuse. In the event of losing the fuse cover the plug must not be used until a replacement fuse cover has been obtained and fitted. A new fuse cover can be obtained from your local Electricity Board. The colour of the correct replacement fuse cover is that of the coloured marks or inserts in the base of the plug. Make sure that the cable does not become trapped when pushing the cooker into position.

INSTALLATION AND OPERATIONAL CHECKS

After installation, check for gas soundness. The supply pressure can be checked at the front left hotplate burner injector.

Fit the hotplate burner bodies and caps, pan supports and shelf shield(s).

Referring to the instructions for use where necessary,

1. Check that the hotplate burners ignite and cross-light to all ports. Check for a steady flame on the low setting.
2. Check that the grill burner ignites and cross-lights to all ports and that the flames remain when the control is released 3 seconds later, Check for a steady flame on the low setting.
3. Check that with the main oven set to mark 9, the burner ignites and that the flames remain when the control is released 3 seconds later. Leave the oven full on with the door closed for 10 minutes, and check that when the control is turned to mark 1 that the flame reduces.
4. Check that with the top oven set to mark 8, the burner ignites and that the flames remain when the control is released 3 seconds later. Leave the oven full on with the door closed for 10 minutes, and check that when the control is turned to mark 1 that the flame reduces.
5. Check the operation of the timer and oven light.

Instruct the user on operation of the cooker.

On those models adjusted for use with LPG, it is normal for the oven and grill burners to burn with yellow tips.

! The appliance must be used by adults only for the preparation of food, in accordance with the instructions outlined in this booklet. Any other use of the appliance (e.g. for heating the room) constitutes improper use and is dangerous. The manufacturer may not be held liable for any damage resulting from improper, incorrect and unreasonable use of the appliance.

Technical Characteristics

Top Oven

Usable Volume:

35 Litres

Main Oven

Usable Volume:

65 Litres

Voltage and Frequency

see data plate

Features

GB

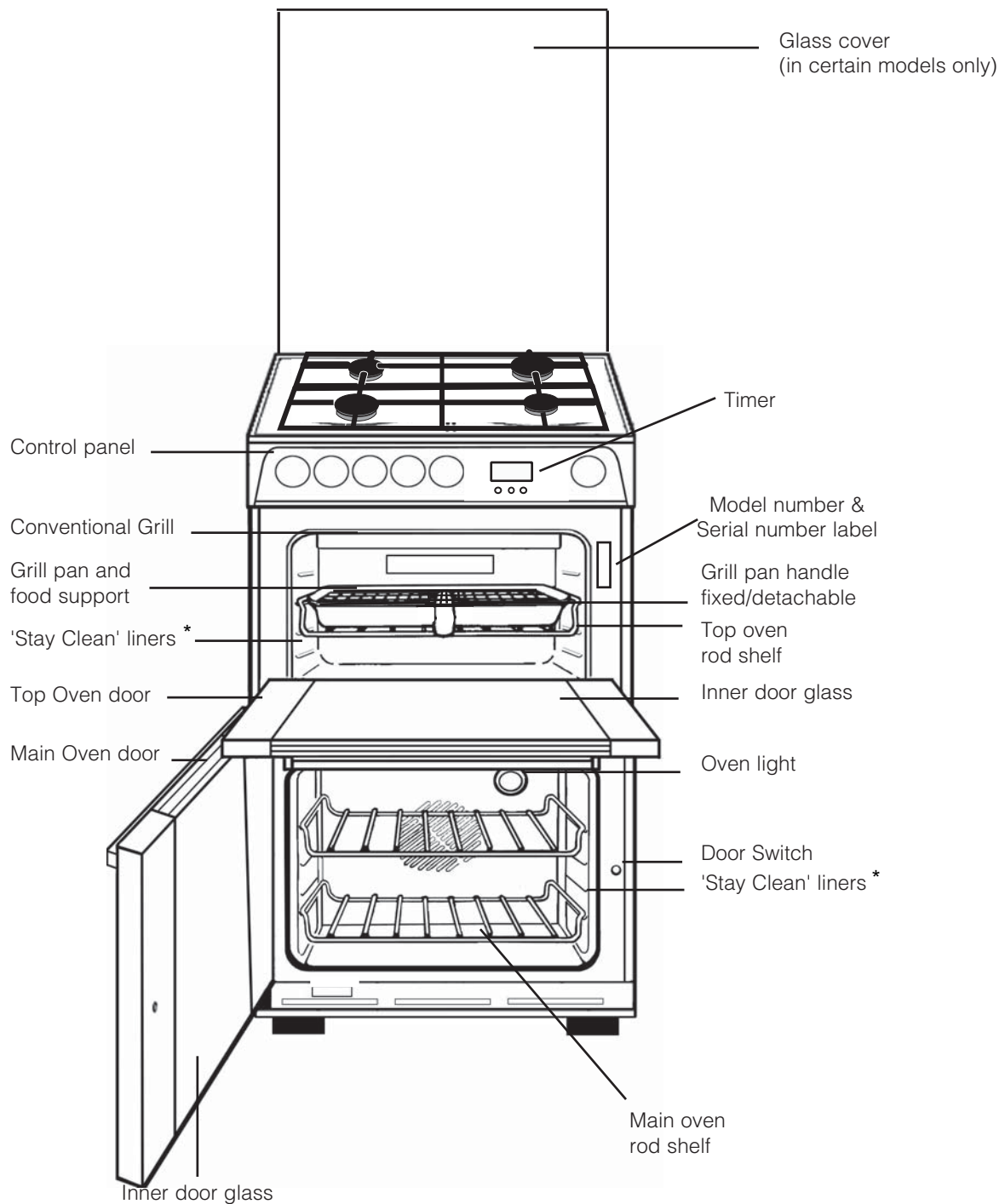

*Only on certain models

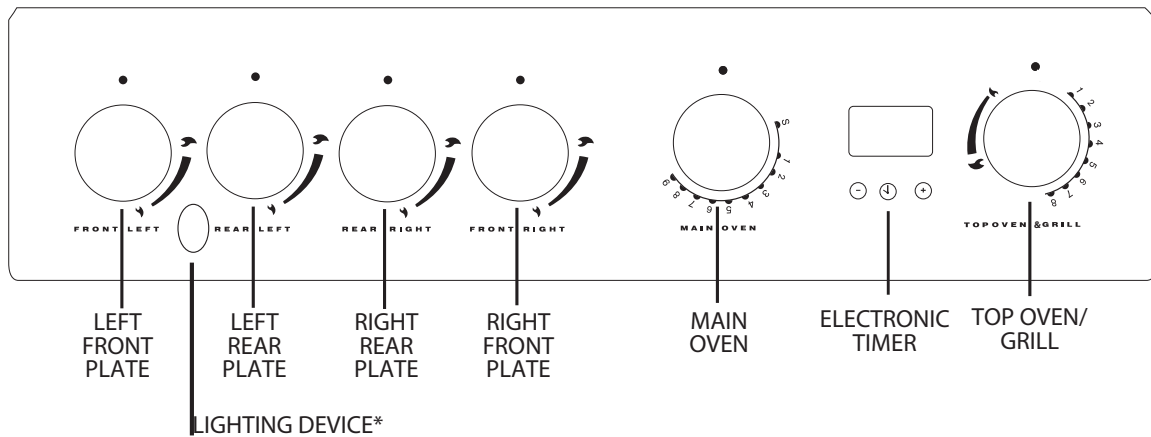

Control Knobs for the gas burners

The position of the gas burner controlled by each one of the knobs is shown by a solid ring ●. To light one of the burners press down and turn the corresponding knob counter clockwise to the maximum 🔥 setting. Each burner can be operated at its maximum, minimum or intermediate power. Shown on the knob are the different symbols for off ● (the knob is on this setting when the symbol corresponds with the reference mark on the control panel), for maximum 🔥 and minimum 🔥. To obtain these settings, turn the knob counter clockwise with respect to the off position. To turn off the burner, turn the knob clockwise until it stops (corresponding again with the ● symbol).

Electronic Ignition for the Gas Hob*

This device operates when a slight pressure is applied to the button marked with ✨ symbol. To light a specific burner just press the button ✨ while pushing the corresponding knob all the way in and turning it counter-clockwise until it lights. For immediate lighting, first press the button and then turn the knob.

! Should the burner flames accidentally go out, turn off the control knob and wait at least 1 minute before trying to relight.

Top Oven / Grill Control

This control switches on the top and bottom heating elements in the top oven.

The temperature of the top oven can be set anywhere between 120°C and 225°C by turning the knob clockwise from 1 to 8.

To set the grill turn the corresponding knob to 🔥

The grill can be operated at minimum 🔥 and maximum 🔥 setting.

Main Oven Control

This control switches on the top and rear heating elements at various times in the main oven, dependent on which mode has been set.

The temperature in the oven can be set anywhere between 110°C and 260°C. by turning the knob clockwise from 1 to 9.

*Only on certain models

Clock/Minute Minder Operation

GB

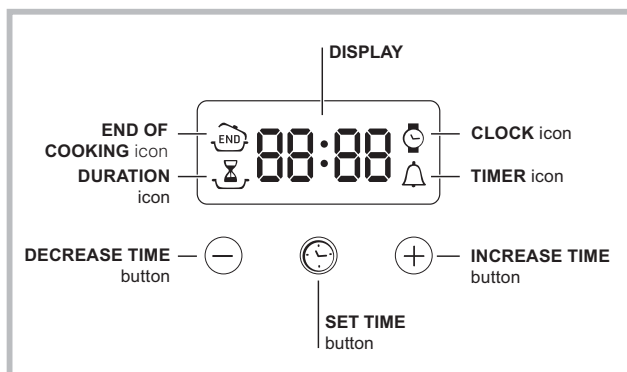

! The Top Oven and Main Oven can be controlled by the automatic timer. When the timer control has been set for one oven, it is possible to use the other oven only during the same automatic cooking programme.
! NEVER operate the grill when the ovens are set to cook automatically because the oven cavity can become warm and this may cause bacterial growth in food.

Setting the clock

! The clock may be set when the oven is switched off or when it is switched on, provided that the end time of a cooking cycle has not been programmed previously. After the appliance has been connected to the mains,

or after a blackout, the icon and the four numerical digits on the DISPLAY will begin to flash.

1. Press the button several times until the icon and the four digits on the display begin to flash.
2. Use the “+” and “-” buttons to adjust the time; if you press and hold either button, the display will scroll through the values more quickly, making it quicker and easier to set the desired value.
3. Wait for 10 seconds or press the button again to finalise the setting.

Setting the minute minder

! This function does not interrupt cooking and does not affect the oven; it is simply used to activate the buzzer when the set amount of time has elapsed.

1. Press the button several times until the icon and the three digits on the display begin to flash.
2. Use the “+” and “-” buttons to set the desired time; if you press and hold either button, the display will scroll through the values more quickly, making it quicker and easier to set the value.
3. Wait for 10 seconds or press the button again to finalise the setting.

The display will then show the time as it counts down. When this period of time has elapsed the buzzer will be activated.

*Only on certain models

Programming cooking*

! A cooking mode must be selected before programming can take place.

Programming the cooking duration

1. Press the button several times until the icon and the three digits on the DISPLAY begin to flash.
2. Use the “+” and “-” buttons to set the desired duration; if you press and hold either button, the display will scroll through the values more quickly, making it quicker and easier to set the value.
3. Wait for 10 seconds or press the button again to finalise the setting.
4. When the set time has elapsed, the text END appears on the DISPLAY, the oven will stop cooking and a buzzer sounds. Press any button to stop the buzzer and turn all control knobs to the 0 position.
 - For example: it is 9:00 a.m. and a time of 1 hour and 15 minutes is programmed. The programme will stop automatically at 10:15 a.m.

Setting the end time for a cooking mode

! A cooking duration must be set before the cooking end time can be scheduled.

1. Follow steps 1 to 3 to set the duration as detailed above.
2. Next, press the button until the icon and the four digits on the DISPLAY begin to flash.
3. Use the “+” and “-” buttons to adjust the cooking end time; if you press and hold either button, the display will scroll through the values more quickly, making it quicker and easier to set the desired value.
4. Wait for 10 seconds or press the button again to finalise the setting.
5. When the set time has elapsed, the text END appears on the DISPLAY, the oven will stop cooking and a buzzer sounds. Press any button to stop it. Programming has been set when the and buttons are illuminated. The DISPLAY shows the cooking end time and the cooking duration alternately.
 - For example: It is 9:00 a.m. and a duration of 1 hour has been programmed. 12:30 is scheduled as the end time. The programme will start automatically at 11:30 a.m.

Cancelling a programme

To cancel a programme:

- press the button until the icon corresponding to the setting you wish to cancel and the digits on the display are flashing. Press the “-” button until the digits 00:00 appear on the display.
- Press and hold the “+” and “-” buttons; this will cancel all the settings selected previously, including timer settings.

The hotplate lid is fitted with a safety device which cuts off the gas supply to the hotplate burners unless the lid is fully open. Do not use the safety device as a means of controlling the hotplate burners.

The hotplate has two high speed burners and two simmering burners which will accommodate pans between 100mm (4") and 240mm (9 1/2") diameter. All pans should be positioned centrally over the burners.

TO USE THE HOTPLATE

1. Remove any items or spillage from the top of the lid and then raise it to its fully open position.
2. Push in and turn the control knob of the chosen burner anti-clockwise to the large flame symbol. Continue to press the ignition button until the sparks light the gas.

For the models with the electronic ignition button (★), press the button and then turn the knob.

3. Turn the control knob anti-clockwise to reduce the heat input. Only turn the control knob between the large flame symbol and the small flame symbol when adjusting the setting.
4. To turn off, turn the control knob fully clockwise to the symbol **O**.

DO NOT use the hotplate unless all pan supports are in position.

DO NOT use mis-shapen pans which may be unstable.

DO NOT use round base woks directly on the pan supports.

DO NOT use the glass lid as a working surface.

Each burner is fitted with a spark ignitor for lighting the gas. To ensure rapid lighting of the burners every time they are used, the ignitors must be kept **clean and dry**. Remove any food spillage or cleaning materials from the ignitor using a small nylon brush such as a tooth brush. Access to the ignitor can be achieved by lifting off the loose burner parts carefully when the burners are cool.

When the hotplate burner bodies and caps are removed for cleaning, be careful not to drop any food particles or cleaning materials into the burner bases, to avoid the possibility of blocking the gas jets.

If aluminium based pans are used, a silvery deposit may appear on the top edge of the pan support fingers. See 'Care and Cleaning' section for cleaning

information.

SAFETY REQUIREMENTS FOR DEEP FAT FRYING

1. Never fill chip pans more than one third full with oil or fat.
2. Never leave oil or fat unattended during the heating or cooling period.
3. Never heat fat or fry with a lid on the pan.
4. Always dry food thoroughly before frying, and lower it slowly into the hot oil or fat. Frozen foods in particular will cause frothing and spitting if added too quickly.
5. Always keep the outside of the pan clean and free from streaks of oil or fat.

HOW TO DEAL WITH A FAT FIRE

1. **Do not** move the pan.
2. Turn off the hotplate burners.
3. Smother the flames with a fire blanket or damp cloth to extinguish the fire. **Do not** use water or a fire extinguisher as the force of it may spread the burning fat or oil over the edge of the pan.
4. Leave the pan for at least 60 minutes before moving it.

Models with Hob Gas Burner Safety Devices to Prevent Leaks

These models can be identified by the presence of the device itself.

! Since the hob burners are equipped with a safety device, you must hold the

control knob in for about 3-7 seconds after the burner has been lighted to allow the gas to pass until the safety thermocouple has heated.

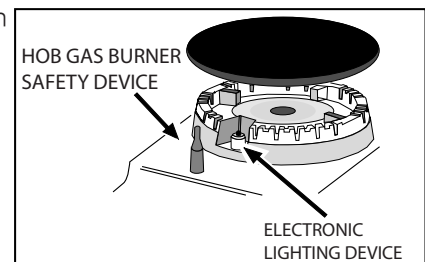

Grill

GB

CAUTION - ACCESSIBLE PARTS MAY BECOME HOT WHEN THE GRILL IS USED.

YOUNG CHILDREN SHOULD BE KEPT AWAY.

The grill is fitted with a safety device that will cut off the gas supply to the burner if the flame is extinguished for any reason. Each time the grill is used, the safety device has to be activated by pushing and holding in the control knob for 3 seconds after the gas has lit.

Grill Pan Handle

The grill pan handle is detachable from the pan to facilitate cleaning and storage. Fix the pan handle securely before use:

1. Fit the handle to the grill pan so that the external 'hooks' embrace the edge of the pan (fig. 1)
2. Make sure that the middle part of the handle fits exactly the protruding support of the pan (fig. 2) and holds the pan from the bottom.

The food must be placed on the rack in the grill pan. Position the grill pan on top of the oven rack. The best results are achieved by placing the oven rack on the uppermost shelves. Pouring a little water into the grill pan will make the collection of grease particles more efficient and prevent the formation of smoke.

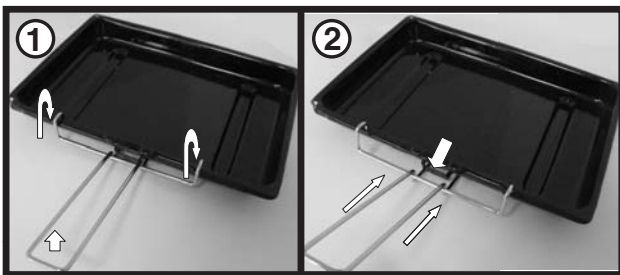

the handle attached by placing the shelf in the middle or lower position and tilting the grill pan over the rear edge of the shelf.

TO USE THE GRILL

1. Open the top oven/grill door and remove the grill pan.
 2. Remove the heat shield from the rear of the shelf for maximum grilling area.
 3. Place the shelf in the appropriate position.
 4. Push in and turn the control knob clockwise to the large flame symbol. Continue to push in the control knob for a further 3 seconds after the gas has lit, to allow time for the safety device to operate. If the burner extinguishes when the control knob is released, repeat the procedure ensuring the control knob is fully depressed and allowing more time for the safety device to operate.
- For the models with the electronic ignition button (

★), press the button and then turn the knob.

5. Slide the grill pan along the shelf towards the rear of the grill compartment until it stops.
6. Turn the control knob anti-clockwise to reduce the heat input. Only turn the control knob between the large flame symbol and the small flame symbol when adjusting the setting.
7. To turn off, turn the control knob anti-clockwise to the symbol **O**.

The grill cannot be used at the same time as the top oven. If for any reason the grill burner has not lit after 15 seconds, turn the control knob to the off position, leave the grill door open and wait for at least one minute before attempting to light the burner again. An odour may be noticed when first using the grill this should cease after a short period of use.

DO NOT use the grill with the door closed.
DO NOT cover the grill pan or grid with aluminium foil as this can hold fat, intensify the heat and create a fire hazard.

RELIGHTING THE BURNER

In the event of the burner flames being accidentally extinguished, turn off the burner control and do not attempt to re-ignite the burner for at least one minute. Grilling can be started from cold but for best results preheat for approximately two minutes. Most cooking is done with the heat on full, but it may be desirable to reduce it for thicker pieces of meat or for keeping food warm.

For au gratin dishes eg. Macaroni Cheese and meringue toppings eg. Baked Alaska, place the dish on the floor of the grill compartment. The base of the grill pan can be used for warming fruit garnishes on the reduced setting.

REMOVE HEAT SHIELD FROM SHELF WHEN GRILLING FOR MAXIMUM GRILLING AREA.

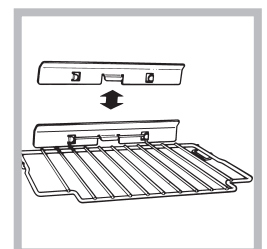

NOTE: Strong detergents used in dishwashers may damage the grill pan grid finish; clean in soapy water as described in CARE AND CLEANING section. Always ensure that the grill pan handle is correctly fitted to the grill pan.

The main oven is fitted with a safety device that will cut off the gas supply to the burner if the flame has been extinguished for any reason. Each time the main oven is used, the safety device has to be activated by pushing and holding in the control knob for 3 seconds after the gas has lit.

The oven has different heat zones - the thermostat settings refer to the temperature on the middle shelf position; above this shelf it is hotter and below it is cooler. Two shelves provide five possible cooking levels enabling full use of the different temperatures inside the oven.

Each shelf has a safety stop to prevent it from being pulled out too far when attending to food. Shelves are removed from the oven by pulling them out to the stop and then lifting them at the front to withdraw.

The maximum size of baking tray that should be used is 325mm x 350mm (13" x 14").

TO USE THE MAIN OVEN

1. Place the oven shelves in the appropriate positions (refer to cooking charts).
2. Push in and turn the control knob fully anti-clockwise. Continue to push in the control knob for a further 3 seconds after the gas has lit to allow time for the safety device to operate. If the burner extinguishes when the control knob is released, repeat the procedure ensuring the control knob is fully depressed and allowing more time for the safety device to operate.

For the models with the electronic ignition button (★), press the button and then turn the knob.

3. Turn the control knob clockwise to the required setting (refer to cooking chart).
4. To turn off, turn the control knob fully clockwise the the symbol **O**.

If for any reason the oven burner has not lit after 15 seconds, turn the control knob to the OFF position. Leave the main oven door open and wait for at least 1 minute before attempting to light the burner again. Never place dishes over the burner.

An odour may be noticed when first using the oven - this should cease after a short period of use.

RELIGHTING THE BURNER

In the event of the burner flames being accidentally extinguished, turn off the burner control and do not attempt to re-ignite the burner for at least one minute.

COLD START COOKING

Anything requiring long slow cooking such as casseroles and rich fruit cakes can be put into a cold oven. Satisfactory results can also be obtained with creamed mixture, rich pastries or yeast mixtures, but for perfection we recommend preheating the oven for about 15 minutes at the gas mark you require for cooking.

ROASTING OF LARGE POULTRY

The maximum weight of poultry that can be accommodated is 11.5kg (25 lbs) of suitable shape. It is important to check that the bird DOES NOT overhang the burner at the back of the oven.

STORAGE AND RE-HEATING OF FOOD

It is vitally important to strictly adhere to the basic principles of food handling and hygiene to prevent the possibility of bacterial growth.

1. If food is to be frozen or not served immediately, cool it in a clean container as quickly as possible.
2. Completely thaw frozen food in the refrigerator before re-heating.
3. Re-heat food thoroughly and quickly either on the hotplate or in a hot oven, Mk. 6, and then serve immediately.
4. Only re-heat food once.

'COOK CHILL' DISHES

These should always be placed in a pre-heated oven ideally on the first or second shelf position. Follow the packet instructions for cooking time.

ALUMINIUM FOIL

If using Aluminium Foil:

1. Remember that it is important to increase the cooking time by one third.
2. Never allow the foil to touch the sides of the oven.
3. Never cover the oven interior with foil.
4. Never cover the oven shelves with foil.

The equivalent degrees Celsius (sometimes called Centigrade) and degrees Fahrenheit are shown below as a guide.

Lower Oven Setting	Temperature °C	Temperature °F
Slow cook	110	230
1	145	293
2	160	320
3	175	347
4	190	374
5	205	401
6	222	432
7	240	464
8	250	482
9	260	500

Main Oven Cooking Chart

GB

The following times and setting are for guidance only. You may wish to alter the setting to give a result more to your satisfaction. When a different setting to that shown below is given in a recipe, the recipe instructions should be followed.

Allow 15 minutes preheat for best results.
Always turn the thermostat knob to Mark 9 first, before turning back to the required Gas Mark.
Shelf position 1 is the highest.

Food	Gas Mark	Shelf Positions	Approx. Cooking Time and Comments
STARTERS			
Patés and Terrines	3 or 4	4	1 ½ - 2 hrs
FISH			
Oily Fish (whole)	4 or 5	3	25 mins - 1 hr, depending on recipe and size of fish.
White Fish (fillets & steaks)	4 or 5	3	25 - 30 mins.
MEAT AND POULTRY			
Veal	5	4	25 mins per lb (450g) + 25 mins.
Beef	4 or 5	4	25 - 30 mins per lb (450g) + 25 mins.
Ham	5	4	40 mins per lb (450g) covered in foil + 40 mins per lb (450g) uncovered.
Lamb	5	4	30 - 35 mins per lb (450g) + 30 mins.
Pork	5	4	40 mins per lb (450g) + 40 mins.
Chicken	5	4	25 mins per lb (450g) + 25 mins.
Duckling & gosling	5	4	25 mins per lb (450g) + 25 mins.
Turkey	4 or 5	4 or 5	15 - 20 mins per lb (450g) + 20 mins.
Game birds	6	4	50 mins Removed bacon for last 15 mins. Add extra 15 mins if roasting brace
Casseroles	3	3 or 4	1 ½ - 6 hrs. (depending on type of meat)
PUDDINGS			
Milk Puddings	3	3 or 4	2 ¼ - 2 ½ hrs stand dish on a baking tray and started with warm milk
Baked Custard	3	3 or 4	45 mins in bain-marie
Baked sponges	4	3	40 - 45 mins
Baked Apples	3	4	30 - 45 mins depending on the size and type of apples
Meringue puddings	1	4 or 5	15 mins or until 'tinged' with brown
Apple Pie 1x9" (230 mm)	6	3	45 - 55 mins stand dish on a baking tray
Fruit crumbles	5 or 6	3	35 - 45 mins

Main Oven Cooking Chart



GB

Food	Gas Mark	Shelf Positions	Approx. Cooking Time and Comments
CAKES, PASTRIES AND BISCUITS			
Small cakes - 2 trays	5	1 & 3	17 - 25 mins
- 1 tray	5	2 or 3 only	"
Victoria sandwich 2x8" (205mm)	4	1 & 3	25 - 35 mins.
Fatless sponge 2x7" (180mm) - 3 egg mix	5	2	20 - 25 mins. 2 tins side by side
Christmas cake	2	3 or 4	4 - 6½ hrs depending on recipe
Madeira cake 7"	4	3	1¼ - 1½ hrs.
Rich Fruit cake 9" (230mm)	2	3	3 - 3½ hrs.
Shortcrust pastry	6	2 or 3	15 mins - 1 hr depending on recipe
Rich Shortcrust pastry - 1 tray	5	2	20 - 40 mins. depending on recipe
Flaky & puff pastry - 2 trays	7	1 & 3	10 - 30 mins. depending on recipe
Flaky & puff pastry - 2 trays		2 or 3	" " " "
Choux pastry - éclairs 1 tray	6	2	35 - 40 mins
Scones - 2 trays	7	1 & 3	10 - 15 mins
Scones - 1 trays		2 or 3	"
Shortbread - 7" (180mm) round	2	4	55 - 1hr depending on thickness
Biscuits - 2 trays	4	1 and 3	15 - 20 mins depending on recipe
Biscuits - 1 trays		2 or 3	" " " "
YEAST MIXTURES			
Bread	7 or 8	3 or 4	45 - 50 mins
Rolls	7 or 8	3 or 4	15 - 20 mins
Chelsea buns	5	2 or 3	30 - 40 mins
MISCELLANEOUS			
Yorkshire Pudding - large	7	1 or 2	45 - 50 mins
Yorkshire Pudding - individual	7	1 or 2	25 - 30 mins
Soufflés	4	3	30 mins
Meringues	Slow Cook	4 & baseplate	2 - 5 hrs starting on shelf 4 until 'set' and then on the baseplate until dried out - turn when necessary.
Baked Potatoes	4 or 5	3	1½ - 4 hrs until soft, depending on size

When baking with two trays or tins on two levels, the top tray is removed first and the lower tray moved up to the top position for a few minutes longer.

Soft Margarine - Use the oven settings recommended by the margarine manufacturer and not those indicated on the cooking chart.

The Slow Cook Setting

GB

The 'Slow Cook' setting on the main oven thermostat is used for slow cooking, keeping food warm and warming plates for short periods.

USING THE 'SLOW COOK' SETTING FOR SLOW COOKING

1. All dishes cooked by the 'Slow Cook' setting should be cooked for a minimum 6 hours. They will 'hold' at this setting for a further hour but marked deterioration in appearance will be noticed in some cases.
2. Joints of meat and poultry should be cooked at Mk. 6 for 30 minutes before turning to the 'Slow Cook' setting and never be cooked lower than the middle shelf position.
3. Joints of meat over 6 lbs (2.7kg) and poultry over 4 lbs 8oz (2 kg) should not be cooked using the 'Slow Cook' setting.
4. Always stand covered joints on a rack over the meat tin to allow good air circulation.
5. A meat thermometer should be used when cooking pork joints and poultry. The internal temperature of the food should reach at least 88°C.
6. This method is unsuitable for stuffed meat and stuffed poultry.
7. Always bring soups, casseroles and liquids to the boil before putting in the oven.
8. Cover casseroles with foil and then the lid to prevent loss of moisture.
9. Always thaw frozen food completely before cooking.
10. Root vegetables will cook better if cut into small pieces.
11. Adjust seasonings and thickenings at the end of the cooking time.
12. Use the zones of heat in the oven, e.g. meringues and milk puddings can be cooked lower in the oven whilst other dishes requiring greater heat can be cooked above them.
13. Egg and fish dishes need only 1-5 hours cooking and should be included in day cooking sessions, when they can be observed from time to time.
14. Dried red kidney beans must be boiled for a minimum of ten minutes after soaking, before inclusion in any dish.

The top oven can be used to cook small quantities of food or used in conjunction with the main oven to provide additional cooking space.

The top oven is fitted with a safety device that will cut off the gas supply to the burner if the flame is extinguished for any reason. Each time the top oven is used, the safety device has to be activated by pushing and holding in the control knob for 3 seconds after the gas has lit.

A gentle flow of air will be blown from underneath the control panel when the grill or top oven is in use.

The shelf in the top oven has a heat shield fitted at the rear. The shield can be removed for cleaning and grilling, but should be replaced when using the oven for best cooking results. It has a safety stop to prevent it from being pulled out too far when attending to food.

The shelf is removed from the oven by pulling it out to the stop and then lifting at the front to withdraw.

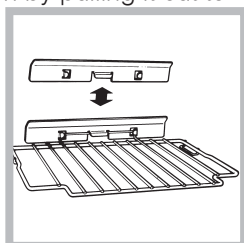

The maximum size of baking tray that should be used is 300mm x 350mm (12" x 14").

TO USE THE TOP OVEN

1. Check that the heat shield is fitted to the shelf.
2. Place the top oven shelf in the appropriate position (refer to cooking chart).
3. Push in and turn the control knob fully anti-clockwise. Continue to push in the control knob for a further 3 seconds after the gas has lit to allow time for the safety device to operate. If the burner extinguishes when the control knob is released, repeat the procedure ensuring the control knob is fully depressed and allowing more time for the safety device to operate.

For the models with the electronic ignition button (★), press the button and then turn the knob.

4. Turn the control knob clockwise to the required setting. (refer to cooking chart).
5. To turn off, turn the control knob clockwise to the symbol **O**.

Always push the door firmly closed to ensure that there is no loss of heat through the door seal.

If for any reason the oven burner has not lit after 15 seconds, turn the control knob to the OFF position. Leave the top oven door open and wait for at least 1 minute before attempting to light the burner again.

GUIDANCE ON USING THE TOP OVEN

1. Best results are obtained by pre-heating the oven for about 15 minutes.
2. Food which is higher than or will rise above 125mm (5") cannot be cooked in the top oven.

Never place dishes over the burner.

An odour may be noticed when first using the oven - this should cease after a short period of use.

RELIGHTING THE BURNER

In the event of the burner flames being accidentally extinguished, turn off the burner control and do not attempt to re-ignite the burner for at least one minute.

The equivalent degrees Celsius (sometimes called Centigrade) and degrees Fahrenheit are shown below as a guide.

Upper Oven Setting	Temperature °C	Temperature °F
1	120	248
2	140	284
3	160	320
4	175	347
5	190	374
6	205	401
7	215	419
8	225	437

Top Oven Cooking Chart

GB

The following times and setting are for guidance only. You may wish to alter the setting to give a result more to your satisfaction. When a different setting to that shown below is given in a recipe, the recipe instructions should be followed.

Allow 15 minutes preheat for best results. Always turn the thermostat knob to Mark 8 first, before turning back to the required Gas Mark.

Food	Gas Mark	Shelf Positions	Approx. Cooking Time and Comments
STARTERS			
Oily and white fish	5	2	20 - 30 mins.
MEAT AND POULTRY			
Beef (medium)	4 or 5	3	25 - 30 mins per lb + 25 - 30 mins.
Ham (covered in foil)	5	3	40 mins per lb + 40 mins
Lamb	5	3	30 - 35 mins per lb + 30 mins.
Pork	5	3	40 mins per lb + 40 mins.
Chicken	5	3	25 mins per lb + 25 mins.
Duckling & Goose	5	3	25 mins per lb + 25 mins.
Turkey	4	3	15 - 20 mins per lb + 15 - 20 mins.
Casseroles	3	3	2 - 4 hrs. depending on meat used
VEGETABLES			
Baked jacket potatoes	5	2	1 ½ hrs.
PUDDINGS			
Milk Puddings (500ml/1pt)	3	2	1 ½ hrs.
Baked Custard (500ml/1pt)	3	2	45 mins - 1 hr. in bain-marie of cold water
Baked Sponge Puddings	4	2	30 - 45 mins
Baked Apples	3	2	45 mins - 1 hr. depending on size
Meringue Topped Puddings	1	2	25 mins until tinged with brown
Apple Tart (1x205 mm)/8")	6	2	60 mins
Fruit Crumble	5	2	45 - 50 mins

If using aluminium foil:

- Remember it is important to increase the cooking time by one third.
- Do not allow the foil to touch the sides of the oven.
- Do not cover the oven interior with foil.
- Do not cover the oven shelves with foil.

Top Oven Cooking Chart



GB

Food	Gas Mark	Shelf Positions	Approx. Cooking Time and Comments
CAKES, PASTRIES AND BISCUITS			
Small Cakes (16 per tray)	5	2	20 - 25 mins
Victoria sandwich (2x180mm / 7")	4	2	25 - 30 mins.
Swiss Roll (3 egg quantity)	6	2	10 - 12 mins.
Christmas cake (1 x 205mm / 8")	2	2 or 3	4 - 5 hrs depending on recipe
Madeira cake (1 x 180mm / 7")	4	2	1 hr.
Rich Fruit cake (1 x 180mm / 7")	2	2 or 3	2¼ - 2½ hrs.
Gingerbread	3	2	1½ - 1¾ hrs.
Scones - 16 per tray	7	2	12 - 15 mins.
Shortbread (1 x 180mm / 7")	2	2	45 mins. - 1hr depending on thickness
Biscuits	4 - 6	2	15 - 25 mins.
Shortcrust Pastry	6	2	15 mins. - 1 hr. depending on recipe
Rich Short Crust	5	2	20 - 30 mins.
Flaky/Puff Pastry	7	2	10 - 30 mins. depending on recipe
Choux Pastry	6	2	25 - 35 mins.
YEAST MIXTURES			
Bread - rolls, plait	7	2 or 3	25 - 35 mins
Tea breads etc.	5	2	25 - 30 mins
MISCELLANEOUS			
Yorkshire Pudding - small	7	2	20 - 25 mins
Yorkshire Pudding - large	7	2	30 - 40 mins
Meringues	1	2	2½ - 4 hrs turn when necessary.

Soft Margarine - Use the oven settings recommended by the margarine manufacturer and **not** those indicated on the cooking chart.

Care and Cleaning

GB

Grill

Remove the grill pan and the wire grid food support, it is best to wash these items immediately after use to prevent stains from being burnt on when used again. Wipe out the Grill compartment, use a fine steel wool soap pad to remove stubborn stains from the grill runners and the floor of the compartment. Wipe over the control panel with a damp cloth and polish with a dry cloth.

Control Panel

Do not use cream cleaners, oven cleaners or aerosols, scouring pads or abrasive powder for cleaning the plastic knobs as damage will occur.

Decorative Trims

It is advisable to clean the decorative trims regularly to prevent any build up of soiling. The recommended method of cleaning is to wipe over the trims with a soft cloth wrung out in warm water or mild non-abrasive cleaner. (If in doubt try the cleaner on a small area of trim which is not noticeable in normal use). Then, after wiping with a cloth wrung out in clear water, dry with a soft clean cloth.

Ovens

Remove the rod shelves and grill pan. Use a fine steel wool soap pad to remove stubborn stains from the rod shelves, grill pan and the floor of the oven. Clean the glass part of the oven door using a sponge and a non-abrasive cleaning product, then dry thoroughly with a soft cloth. Do not use rough abrasive material or sharp metal scrapers as these could scratch the surface and cause the glass to crack.

Oven Shelf Supports

The shelf supports are removable and dishwasher safe.

To remove hold the support at the front, lift and pull away from the oven side, this can then be cleaned in a sink or a dishwasher. When removed it allows access to the oven side, which can be cleaned with warm soapy water.

To refit the support, insert the longer leg into the rear fixing hole and push in the front leg.

,Stay Clean' Panel*

,Stay Clean' panels are covered with a special enamel which absorbs cooking soils. At higher temperatures the soiling is slowly destroyed. In most cases normal cooking at higher temperatures will permit this cleaning to take place automatically. However, if higher cooking

*Only on certain models

temperatures are not used regularly then it may be necessary, in order to prevent heavy soiling, to run the oven at maximum temperature for at least two hours, from time to time. The ,Stay Clean' panel can be washed in warm soapy water followed by rinsing in clear water. Dry well with a soft cloth.

NOTE: Do not use enzyme washing powder, harsh abrasives or chemical oven cleaners of any kind.

Oven Lamp Replacement

Open the oven door and remove the rod shelves. Using a suitable cloth to protect the fingers grip the light glass dome, unscrew anti-clockwise and lift. Reach into the aperture with fingers, and unscrew the lamp anticlockwise. Fit replacement lamp (25W 300°C rated SES), refit dome.

! To avoid electric shock please ensure that the electricity supply to the appliance is switched off and the appliance is fully cold, before removing the lamp lens.

! Never use steam cleaners or pressure cleaners on the appliance.

! Clean the glass part of the oven door using a sponge and a non-abrasive cleaning product, then dry thoroughly with a soft cloth. Do not use rough abrasive material or sharp metal scrapers as these could scratch the surface and cause the glass to crack.

! The accessories can be washed like everyday crockery (even in your dishwasher).

! Switch off the electricity supply and allow to cool before cleaning the cooker.

! Clean the cooker regularly and wipe up spills soon after they occur to prevent them from becoming burnt on. Never use biological washing powder, caustic cleaners, harsh abrasives, scouring pads, steam cleaners, aerosol cleaners or oven chemical cleaners of any kind.

! If it is necessary to remove the cooker for cleaning, ensure that it is cool and beware that it is heavy (approximately 70 kg 155 lbs).

! To move the cooker forward, open the top oven/grill door and with both hands positioned under the roof of the compartment, lift and pull forward. Replace by pushing the cooker backwards.

! Check that the cooker is level. Take care not to damage any floor coverings.

Doors
(models with double door glass panel)

Wipe over the outer door glass panels with a cloth wrung out in warm soapy water, then after wiping with a cloth wrung out in clear water, dry with a soft clean cloth. Ensure that glass doors are not subjected to any sharp mechanical blows.

Glass Inner Door Panel (where fitted) –



open the door fully and carefully slide the inner glass towards you, taking care not to allow the glass to fall.

The glass panel may now be washed at the sink. Stubborn stains can be removed by using a fine steel wool soap pad. Ensure the glass panel is not subjected to any sharp mechanical blows. Take particular care not to damage the inner surface which is coated with a heat reflective layer. After cleaning, rinse and dry with a soft cloth. For slight soiling the inner glass panel may be cleaned, while still warm, without removing it from the door.

Warning: Oven must not be operated with inner door glass removed.

SIDE OPENING DOORS

Cleaning the door glass is the same as the drop down doors, except take care to support the weight of the inner glass when removing and refitting.

Take care during cleaning not to damage or distort the door seals. Do not lift the door seal from the oven chassis, if necessary remove the seal by carefully unhooking the corner clips.

Take care that the rating label edges are not lifted during cleaning, and furthermore that the lettering is not blurred or removed.

When refitting the glass make sure it is fitted correctly i.e. reflective face is fitted the right way round.

COOKER FINISH	CLEANING METHOD
<p>Vitreous Enamel Door inner panels, pan supports, burner caps, roasting dish, grill pan, main oven base, inside of grill compartment. Hotplate</p>	<p>Cloth wrung out in warm soapy water. Stubborn stains can be removed with a cream paste, liquid cleaner or by rubbing with fine steel wool soap pads. Check that the cleaning agent is approved by the Vitreous Enamel Association.</p>
<p>Paint Side panels.</p>	<p>Wash with a cloth wrung out in warm soapy water only. DO NOT USE ABRASIVES.</p>
<p>Aluminium Hotplate burner bodies, lid rear trim.</p>	<p>Similar to paint cleaning above. Use a nylon brush to remove any cleaning materials, water or dirt from the hotplate burner bodies.</p>
<p>Glass</p>	<p>As for enamel cleaning. Polish with a clean dry cloth or kitchen roll.</p>
<p>Chromium Plating Oven shelves, grill pan grid, grill pan handle support.</p>	<p>Wipe with a cloth wrung out in warm soapy water. A fine steel wool soap pad e.g. Brillo, Ajax, or a chrome or stainless steel cleaner may be used.</p>
<p>Plastic Control knobs.</p>	<p>Wipe with a cloth wrung out in warm soapy water.</p>
<p>Stainless Steel Hotplate, control panel, grill pan handle,</p>	<p>Wipe with a cloth wrung out in warm soapy water. Polish with a clean dry cloth or kitchen towel. For stubborn stains, use a proprietary stainless steel cleaner and follow the instructions on the container.</p>

Care and Cleaning

GB

BURNER MAINTANANCE INSTRUCTIONS

Before cleaning the burners ensure the appliance is switch off and isolated from the electrical supply and the appliance is cold.

MAIN OVEN

When the main oven is used regularly, its burner is susceptible to being covered with grease and dirt. This might result in problems with the burner's ignition as well as the uneven or disappearing flame.

To solve the problem clean the burner with a small amount of water- diluted cleaner (e.g. CIF) using a small brush (e.g. a toothbrush). After cleaning wipe the burner with a cloth to remove the detergent waste and let it dry for at least 2 hours.

Before cleaning, to reach the burner easily unscrew the two screws and take off the shield protecting the burner (in main oven burner only).

WARNING!

1. Brush the burner in the directions indicated below.
2. DO NOT re-ignite the burner with the detergent residue.



WARNING!

1. Brush the burner in the directions indicated below.
2. DO NOT re-ignite the burner with the detergent residue.

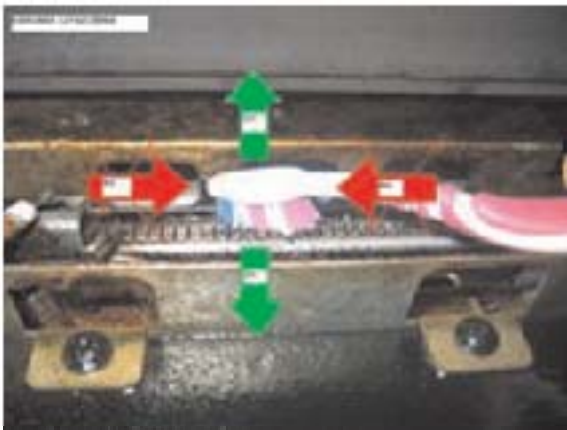

TOP OVEN/ MAIN OVEN

When the Top oven/grill is used regularly, its burner is susceptible to being covered with grease and dirt.

This might result in problems with the burner's ignition as well as the uneven or disappearing flame.

To solve the problem clean the burner with a small amount of water- diluted cleaner (e.g. CIF) using a small brush (e.g. a toothbrush). After cleaning wipe the burner with a cloth to remove the detergent waste and let it dry for at least 2 hours.

Something Wrong with your Cooker

Before contacting your Service Centre or Installer, check the problem guide below, there may be nothing wrong with your cooker.

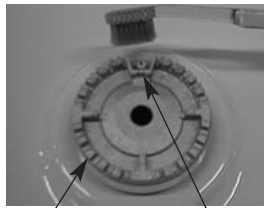
PROBLEM	CHECK
<p>Burner will not light:</p> <p style="text-align: center;"><i>Hotplate burner:</i></p>  <p style="text-align: center;">Burner ports Ignitor</p>	<p>If all burners fail to ignite: Check that sparks appear at the burners; a clicking noise should be heard. If not;</p> <p>Check that the electricity supply is turned on. If the electricity supply has failed, all burners can be lit by a match.</p> <p>If only one burner fails to ignite: Check that the burner is dry and that spillage of food or cleaning fluid remains are not affecting the ignitor or burner ports. Clean away any debris with a dry nylon brush such as an old toothbrush. If a wire wool pad has been used for cleaning around the burner ensure the ignitor is free from any stray strands. Any water on the burner should be dried with a cloth or kitchen towel.</p> <p>On the hotplate make sure that all the burner parts are correctly seated.</p>
<p>Slight odour or small amount of smoke when grill / oven used first time.</p>	<p>This is normal and should cease after a short period.</p>
<p>Oven cooks too fast or too slow.</p>	<p>Check that the gas mark and shelf positions are as recommended in the Oven Cooking Charts. However, it may be necessary to increase or decrease the recommended setting slightly to suit your taste.</p>
<p>Cannot set an "Auto Cook" programme or cannot get the timer to turn the oven on or off at the required times.</p>	<p>Read the Timer instructions in this book carefully remembering that the Cook period is the length of time that the timer will switch the oven(s) on as part of an Auto Cooking Programme.</p>
<p>Timer Display shows "0:00" with "Auto" Flashing.</p>	<p>The electricity supply to the cooker may have been interrupted, but has now come back on again. Set the correct time of day by following the instructions given in the timer section of this book.</p>
<p>Main oven does not work, but the grill, top oven and hotplate burners work.</p>	<p>The timer may be set for an Auto Cooking Programme. Check the timer to see if "AUTO" is illuminated. If it is, follow the instructions given in the timer section of this book to cancel the Auto Cooking Programme.</p>
<p>Oven lamp does not work.</p>	<p>The oven lamp is not covered by the guarantee. The part is easily changed (see the section on oven lamp replacement). A new lamp may be obtained from our Parts department, (see back page).</p>

Disposal of your product

To minimise the risk of injury to children please dispose of your product carefully and safely. Remove all doors and lids. Remove the mains cable (where fitted) by cutting off flush with the appliance and always ensure that no plug is left in a condition where it could be connected to the electricity supply.

To help the environment, Local Authority instructions should be followed for the disposal of your product.



Disposal of old electrical appliances

The European Directive 2002/96/EC on Waste Electrical and Electronic Equipment (WEEE), requires that old household electrical appliances must not be disposed of in the normal unsorted municipal waste stream. Old appliances must be collected separately in order to optimise the recovery and recycling of the materials they contain and reduce the impact on human health and the environment.

The crossed out „wheeled bin” symbol on the product reminds you of your obligation, that when you dispose of the appliance it must be separately collected.

Consumers should contact their local authority or retailer for information concerning the correct disposal of their old appliance.

Guarantee

12 months Parts and Labour Guarantee

Your appliance has the benefit of our manufacturer's guarantee, which covers the cost of breakdown repairs for twelve months from the date of purchase.

This gives you the reassurance that if, within that time, your appliance is proven to be defective because of either workmanship or materials, we will, at our discretion, either repair or replace the appliance at no cost to you.

The guarantee is subject to the following conditions:

- The appliance has been installed and operated correctly and in accordance with our operating and maintenance instructions.
- The appliance is only used on the electricity or gas supply printed on the rating plate.
- The appliance has been used for normal domestic purposes only.
- The appliance has not been altered, serviced, maintained, dismantled or otherwise interfered with by any person not authorised by us.
- Any repair work must be undertaken by us or our appointed agent.
- Any parts removed during repair work or any appliance that is replaced become our property.
- The appliance is used in the United Kingdom or Republic of Ireland.

The guarantee does not cover:

- Damage resulting from transportation, improper use, neglect or interference or as a result of improper installation.
- Replacement of any consumable item or accessory. These include but are not limited to: plugs, cables, batteries, light bulbs, fluorescent tubes and starters, covers and filters.
- Replacement of any removable parts made of glass or plastic.

THE GUARANTEE WILL NOT APPLY IF THE APPLIANCE HAS BEEN USED IN COMMERCIAL OR NON-DOMESTIC PREMISES.

5 Year Parts Guarantee

Hotpoint also offers you a FREE 5 year parts guarantee. This additional guarantee is conditional on you registering your appliance with us and the parts being fitted by one of our authorised engineers. There will be a charge for our engineer's time. To activate the extra parts warranty on your appliance, simply call our registration line on **08448 24 24 24 (ROI 01 230 0800)**

Extended Guarantees

We offer a selection of protection plans that enable you to fully cover yourself against the expense of repair bills for the life of your policy. To find the ideal plan for you please call our advice line on **08448 226 226 (ROI 01 230 0233)**

Free Helpdesk Service

We have a dedicated team who can provide free advice and assistance with your appliance if you experience any technical difficulties within the first 90 days of ownership. Simply call our Hotpoint Service Hotline on **08448 224 224 (ROI 0818 313 413)** for telephone assistance, or, where necessary, to arrange for an engineer to call.

After Sales Service

No one is better placed to care for your Hotpoint appliance during the course of its working life than us - the manufacturer.

Essential Contact Information

Hotpoint Service

We are the largest service team in the country offering you access to 400 skilled telephone advisors and 1100 fully qualified engineers on call to ensure you receive fast, reliable, local service.

UK: 08448 224 224

Republic of Ireland: 0818 313 413

www.hotpoint.co.uk

Please note: Our advisors will require the following information:

Model number

Serial number

Parts & Accessories

We supply a full range of genuine replacement parts as well as accessory products that protect and hygienically clean your appliance to keep it looking good and functioning efficiently throughout its life.

UK: 08448 225 225

Republic of Ireland: 0818 313 413

www.hotpointservice.co.uk

Appliance Registration

We want to give you additional benefits of Hotpoint ownership. To activate your FREE 5 year parts guarantee you must register your appliance with us.

UK 08448 24 24 24

Republic of Ireland: 01 230 0800

www.hotpointservice.co.uk

As part of Hotpoint's continued commitment to helping the environment, Hotpoint reserves the right to use quality, recycled components to keep down customer costs and minimise material wastage.

Indesit Company UK Limited, Morley Way, Peterborough, PE2 9JB

Indesit Company, Unit 49 Airways Industrial Estate, Dublin 17