

## FRONT

# EAR FORCE® STEALTH 300

## QUICK START GUIDE GUIDE DE DÉMARRAGE RAPIDE

**IMPORTANT**  
READ BEFORE USING

**À LIRE**  
AVANT TOUTE UTILISATIO

### Any questions? Des questions?

[turtlebeach.com/Stealth300](http://turtlebeach.com/Stealth300)

FOR MODEL: Stealth 300 for PS4™

## Package Contents Contenu de la boîte

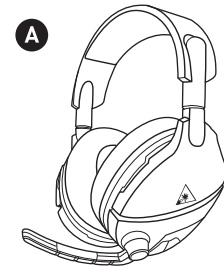

Stealth 300 Headset  
Casque Stealth 300

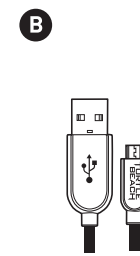

USB Charging Cable  
Câble de chargement USB

426-023-001-011 RB

## Headset Controls

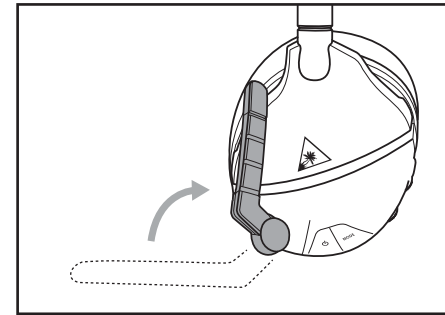

**Mic Mute**  
Flip up mic to mute  
Option microphone muet  
Remonter le microphone  
pour le couper

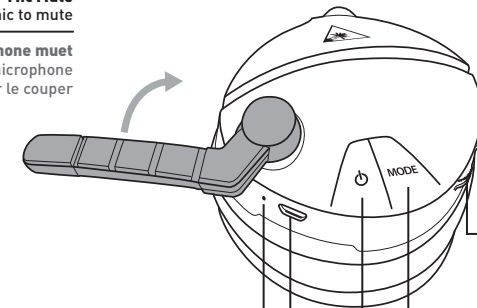

**Master Volume**  
Volume principal

**Mic Monitor Volume**  
Volume du retour micro

**Preset Button**  
Press = Cycle EQ Audio Presets

**Bouton de presets**  
Appuyez pour parcourir les  
presets audio d'égalisation

**Power LED**  
Solid Green = Headset On  
Blinking Red = Battery Low

(USB Connected)  
Solid Red = Charging  
Blinking Green = Fully Charged

**Indicateur d'alimentation**

Témoin vert = casque allumé  
Rouge clignotant = batterie faible

(Branché sur un port USB)  
Témoin clignotant = en chargement  
Rouge vert = chargé

**USB Charge Port**  
Port USB pour le chargement

**Power Button**  
Press and Hold = Power On/Off

**Bouton d'alimentation**  
Appuyer longuement pour allumer/éteindre

EQ Presets   Présets d'égalisation	
1 tone = Signature Sound	1 bip = son emblématique
2 tones = Bass Boost	2 bips = amplification des basses
3 tones = Bass + Treble Boost	3 bips = amplification des basses et des aigus
4 tones = Treble Boost	4 bips = amplification des aigus

## PS4™ Setup Configuration PS4™

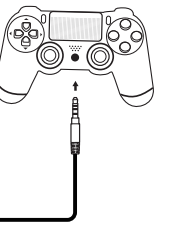

- Go to Settings >> Devices >> Audio Devices
- Set Input & Output Device to Headset Connected to Controller
- Set Output to Headphones to All Audio
- Set Volume Control (Headphones) level to maximum
- Select Adjust Microphone Level and follow the on-screen instructions to calibrate your microphone

- Ouvrez Paramètres >> Périphériques >> Périphériques audio
- Dans Périphérique d'entrée et Périphérique de sortie, sélectionnez Casque branché à la manette.
- Dans Sortie vers le casque, sélectionnez Tout Audio.
- Le niveau de volume du paramètre Réglage du volume (casque) doit être au maximum.
- Sélectionnez Régler le niveau du microphone et suivez les instructions à l'écran pour régler votre microphone.

## BACK

ES

- Ve a Configuración >> Dispositivos >> Dispositivos de sonido
- Configura los dispositivos de entrada y de salida a los auriculares conectados al mando
- Configura la salida a los auriculares a todos los sonidos
- Configura el nivel del control de volumen (auriculares) al máximo
- Selecciona Ajustar el nivel del micrófono y sigue las instrucciones para calibrar el micrófono

IT

- Impostazioni >> Dispositivi >> Dispositivi audio.
- Seleziona come dispositivo di ingresso e di uscita le cuffie collegate al controller.
- Imposta l'opzione Riproduci l'audio tramite cuffie su Tutto l'audio.
- Imposta il livello di Controllo del volume (cuffie) al massimo.
- Seleziona l'opzione Regola il livello del microfono e seguire le istruzioni a schermo per calibrare il microfono.

SE

- Gå till Inställningar >> Enheter >> Ljudenheter.
- Ställ in In- och utdataenheter till Headset anslutet till handkontroll.
- Ställ in Utdata till hörlurar till Allt ljud.
- Ställ in volymkontroll (hörlurar) till maximal nivå.
- Välj Justera mikrofonnivå och följ instruktionerna på skärmen för att kalibrera din mikrofon.

NL

- Ga naar Instellingen >> Apparaten >> Audioapparaten
- Stel Invoer- en uitvoerapparaat in op Headset aangesloten op controller
- Stel de Uitvoer naar hoofdtelefoon in op Alle audio
- Stel Volumebediening (hoofdtelefoon) in op maximaal
- Selecteer Microfoonniveau aanpassen en volg de instructies in beeld om je microfoon te kalibreren.

DE

- Wähle Einstellungen >> Geräte >> Audiogeräte.
- Wähle unter Eingabe- und Ausgabe-Gerät das mit dem Controller verbundene Headset aus.
- Stelle die Ausgabe an Kopfhörer auf Gesamter Sound ein.
- Stelle die Lautstärkeregelung (Kopfhörer) auf das Maximum ein.
- Wähle die Option zur Einstellung des Mikrofonpegels und folge den Anweisungen zur Kalibrierung deines Mikrofons.

PT

- Dirigi-se a Definições >> Dispositivos >> Dispositivos de Áudio.
- Selecionar os auscultadores ligados ao comando como o dispositivo de entrada e saída de áudio.
- Definir a Saída nos Auscultadores para Todo o Áudio.
- Definir o nível do Controlo de Volume (Auscultadores) no máximo.
- Selecionar Ajustar nível do microfone e seguir as instruções de calibração do microfone no ecrã.

DK

- Gå ind i Indstillinger >> Enheder >> Lydenheder
- Sæt Input- og output-enheder til Headset forbundet til controller
- Sæt Output til hovedtelefoner til Al lyd
- Sæt Lydstyrke (Hovedtelefoner) til det maksimale
- Vælg Justér mikrofonlydstyrke, og følg instruktionerne på skærmen for at kalibrere din mikrofon

## PROSPECS™ GLASSES FRIENDLY DESIGN SYSTÈME PROSPECS™ POUR LE PORT DE LUNETTES EN TOUT CONFORT

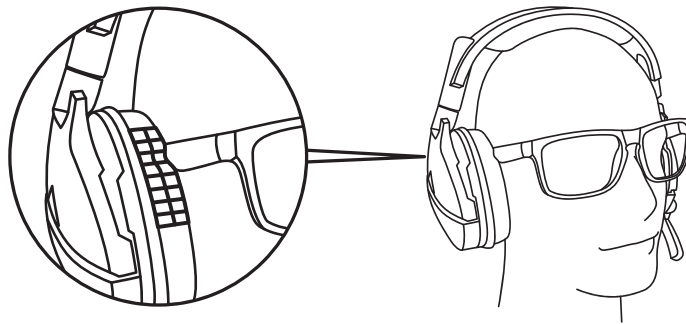

Originally created for the Elite Pro Tournament Gaming Headset, Turtle Beach's exclusive ProSpecs™ glasses friendly technology is built into the Stealth 300, featuring an advanced ear cushion design and materials that allow gamers who wear glasses to finally play in comfort.

Conçu à l'origine pour le casque de jeu de compétition Elite Pro, le système ProSpecs™, une exclusivité de Turtle Beach, est aussi intégré au casque Stealth 300. Le design et les matériaux sophistiqués des coussinets permettent aux porteurs de lunettes de jouer enfin en tout confort.

## Charging Chargement

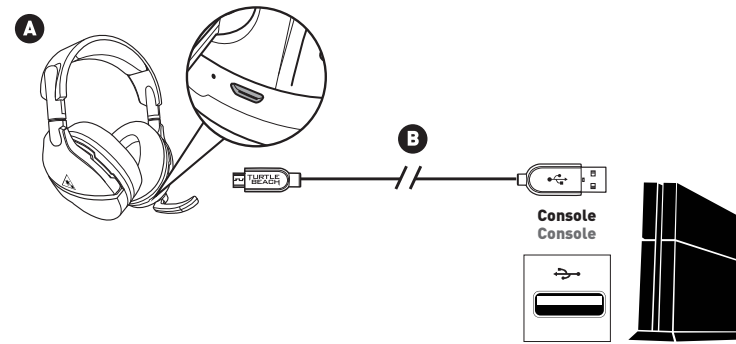

The Stealth 300 uses a rechargeable battery. Make sure to charge it regularly.

### Headset Storage:

Always charge your headset before storing it for any extended period of time (greater than 3 months). Never store the unit in temperatures above 113°F/45°C.

Le Stealth 300 dispose d'une batterie rechargeable. Assurez-vous de la charger régulièrement.

### Rangement du casque :

Chargez toujours votre casque avant de le ranger pour une longue durée (plus de 3 mois). Ne stockez jamais le casque à des températures supérieures à 45°C.

## Regulatory Compliance Statements for the Ear Force Stealth 300P

### Federal Communications Commission (FCC) Compliance Notices

#### Class B Interference Statement

This equipment has been tested and found to comply with the limits for a Class B digital device, pursuant to Part 15 of the FCC Rules. These limits are designed to provide reasonable protection against harmful interference in a residential installation. This equipment generates, uses, and can radiate radio frequency energy and, if not installed and used in accordance with the instructions, may cause harmful interference to radio communications. However, there is no guarantee that interference will not occur in a particular installation. If this equipment does cause harmful interference to radio or television reception, which can be determined by turning the equipment off and on, the user is encouraged to try to correct the interference by one or more of the following measures:

- Reorient or relocate the receiving antenna.
- Increase the separation between the equipment and receiver.
- Connect the equipment into an outlet on a circuit different from that to which the receiver is connected.
- Consult the dealer or an experienced radio/TV technician for help.

#### FCC Cautions:

This device complies with Part 15 of the FCC Rules. Operation is subject to the following two conditions: (1) This device may not cause harmful interference, and (2) this device must accept any interference received, including interference that may cause undesired operation.

This product is compliant with the Consumer Product Safety Improvement Act of 2008, Public Law 110-314 (CPSIA)

### Canadian ICES Statements

Canadian Department of Communications Radio Interference Regulations

This digital apparatus does not exceed the Class B limits for radio-noise emissions from a digital apparatus as set out in the Radio Interference Regulations of the Canadian Department of Communications. This Class B digital apparatus complies with Canadian ICES-003.

Règlement sur le brouillage radioélectrique du ministère des Communications

Cet appareil numérique respecte les limites de bruits radioélectriques visant les appareils numériques de classe B prescrites dans le Règlement sur le brouillage radioélectrique du ministère des Communications du Canada. Cet appareil numérique de la Classe B est conforme à la norme NMB-003 du Canada.

### European Union and European Fair Trade Association Regulatory Compliance

This equipment may be operated in the countries that comprise the member countries of the European Union and the European Fair Trade Association. These countries, listed below, are referred to as The European Community throughout this document.

AUSTRIA, BELGIUM, BULGARIA, CYPRUS, CZECH REPUBLIC, DENMARK, ESTONIA, FINLAND, FRANCE, GERMANY, GREECE, HUNGARY, IRELAND, ITALY, LATVIA, LITHUANIA, LUXEMBOURG, MALTA, NETHERLANDS, POLAND, PORTUGAL, ROMANIA, SLOVAKIA, SLOVENIA, SPAIN, SWEDEN, UNITED KINGDOM, ICELAND, LICHTENSTEIN, NORWAY, SWITZERLAND

### Declaration of Conformity

Marking by this symbol:

indicates compliance with the Essential Requirements of the Radio Equipment Directive (RED) of the European Union (2014/53/EU). This equipment meets the following conformance standards:

**Safety:** EN 60950-1:2006 + A1:2009 + A1:2010 + A12:2011 + A2:2014 (T-Mark License), IEC 60950-1:2005 (2nd Ed.) + Am.1:2009 + Am.2:2013 (CB Scheme Certificate), EN 60335-1:2013, EN 60335-2:2013, EN 71-3:2013

Additional licenses issued for specific countries available on request

**Emissions:** EN 55022:2012, CISPR 32:2015

### Immunity:

EN 55024:2010, CISPR 24:2010  
EN 61000-4-2:2009, EN 61000-4-3:2006 + A1:2008 + A2:2010,  
EN 61000-4-8:2010

These products are licensed, as required, for additional country specific standards for the International Marketplace. Additional issued licenses available upon request.

### Environmental:

Low Voltage Directive 2014/25/EU, RoHS 2011/65/EU, REACH 2006/1907/EC, WEEE 2012/19/EU, Packaging 94/62/EC, Battery 2006/66/EC, Toys Safety Directive 2009/48/EC

**Warning!** This is a Class B product. In a domestic environment, this product may cause radio interference, in which case, the user may be required to take appropriate measures.

**Achtung!** Dieses ist ein Gerät der Funkstörleistungsklasse B. In Wohnbereichen können bei Betrieb dieses Gerätes Rundfunkstörungen auftreten, in welchen Fällen der Benutzer für entsprechende Gegenmaßnahmen verantwortlich ist.

**Attention!** Ceci est un produit de Classe B. Dans un environnement domestique, ce produit risque de créer des interférences radioélectriques, il appartiendra alors à l'utilisateur de prendre les mesures spécifiques appropriées.

Please visit the following URL for a complete copy of the Declaration of Conformity: <http://www.turtlebeach.com/homologation>



This symbol on the product or its packaging indicates that this product must not be disposed of with your other household waste. Instead, it is your responsibility to dispose of your waste equipment by handing it over to a designated collection point for the recycling of waste electrical and electronic equipment. The separate collection and recycling of your waste equipment at the time of disposal will help conserve natural resources and ensure that it is recycled in a manner that protects human health and the environment. For more information about where you can drop off your waste for recycling, please contact your local authority, or where you purchased your product.

Turtle Beach Europe Ltd is obligated as a producer with a main activity of selling under The Producer Responsibility Obligations (Packaging Waste) Regulations 2007. To fulfil our obligation we are registered with Comply Direct and their Recycling Room. Here you will find advice and information on packaging waste management, recycling symbols and the waste hierarchy principles of reduce, reuse and recycle.

<https://www.complydirect.com/the-recycling-room/>

### To Access the Rating Label:

Etiquette :

- Remove the left ear pad, start by pulling the ear pad straight up using your thumb.
- Once you've released the cloth from the lip on top, pull the ear pad straight back and it should slip right off.

1. Retirez le coussinet gauche en commençant par le tir vers le haut à l'aide de votre pouce.

2. Une fois le haut du tissu délogé, il vous suffit de tirer le coussinet vers vous pour le retirer facilement.



To replace the ear pad, follow the same process in reverse. Pour remettre le coussinet en place, veuillez suivre la procédure inverse.

### Class B

(Broadcasting Communication Equipment for Home Use)

As an electromagnetic wave equipment for home use (Class B), this equipment is intended to use mainly for home use and may be used in all areas.