

Alderley 5ft Headboard

Assembly Instructions - Please keep for future reference

634/1457

634/1725

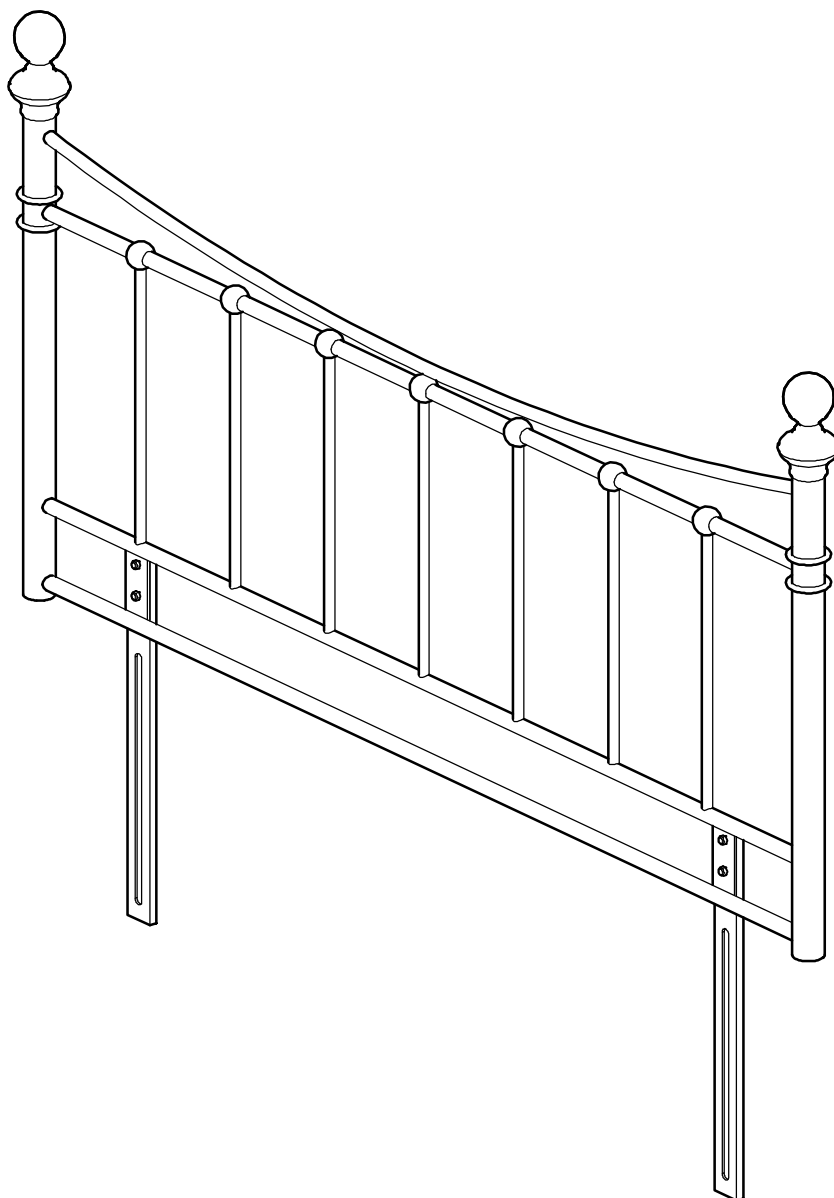

Dimensions

Width - 163cm

Height - 123cm

Important – Please read these instructions fully before starting assembly

If you need help or have damaged or missing parts, call the **Customer Helpline:**
Argos = 0345 6400800



Safety and Care Advice

Important – Please read these instructions fully before starting assembly

- Check you have all the components and tools listed on the following pages.
- Remove all fittings from the plastic bags and separate them into their groups.
- Keep children and animals away from the work area, small parts could choke if swallowed.
- Make sure you have enough space to layout the parts before starting.

- During assembly do not stand or put weight on the product, this could cause damage.
- Assemble the item as close to its final position (in the same room) as possible.
- Assemble on a soft level surface to avoid damaging the unit or your floor.
- Parts of the assembly will be easier with 2 people.



- To reduce the likelihood of damaging your product please ensure that your power drill is set on a low torque setting.

Care and maintenance

- Only clean using a damp cloth and mild detergent, do not use bleach or abrasive cleaners.
- From time to time check that there are no loose screws on this unit.
- This product should not be discarded with household waste. Take to your local authority waste disposal centre.

Handy Hints

- Assemble all parts and bolts loosely during assembly, only once the product is complete should you fully tighten the bolts
- Regularly check and ensure that all bolts and fittings are tightened properly.

Components - Panels

If you have damaged or missing components, call the
Customer Helpline: Argos = 0345 6400800

Please check you have all the panels listed below

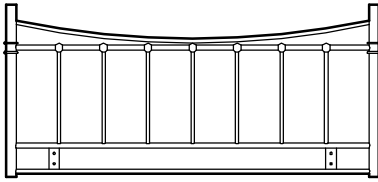

1 Headboard frame
 (160.6 x 66cm)

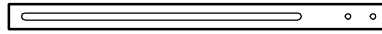

2 Leg x 2 (61 x 4cm)

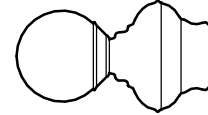





3 Finial x 2 (dia 7.3 X 12.9cm)

Components - Fittings

Please check you have all the fittings listed below

Note: The quantities below are the correct amount to complete the assembly. In some cases more fittings may be supplied than are required.

<p>A  17mm Bolt x 4</p>	<p>B  Nut x 4</p>	<p>C  Hex key x 1</p>
<p>D  Wrench x 1</p>		

Ruler - Use this ruler to help correctly identify the screws

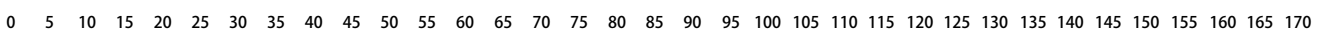

Assembly Instructions

Step 1

Assemble leg

Assemble legs **2** to headboard frame **1** using bolts **A** and nuts **B** and secure tightly.

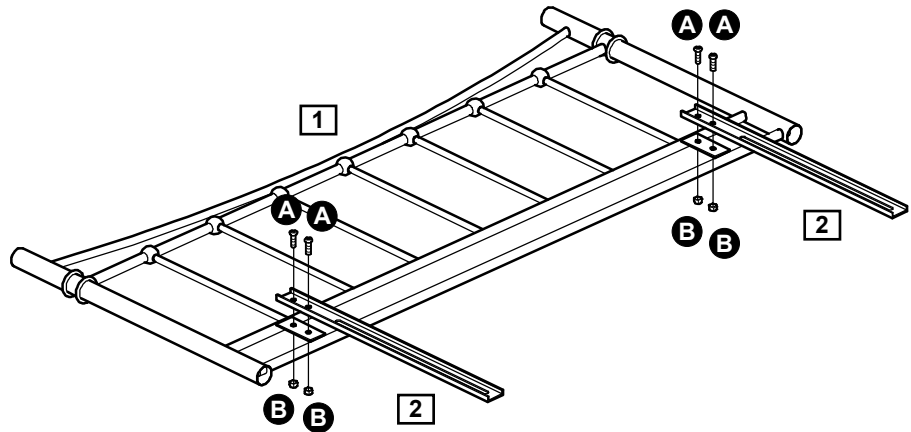

Step 2

Assemble finial

Assemble finials **3** to headboard frame.

Assembly is complete.

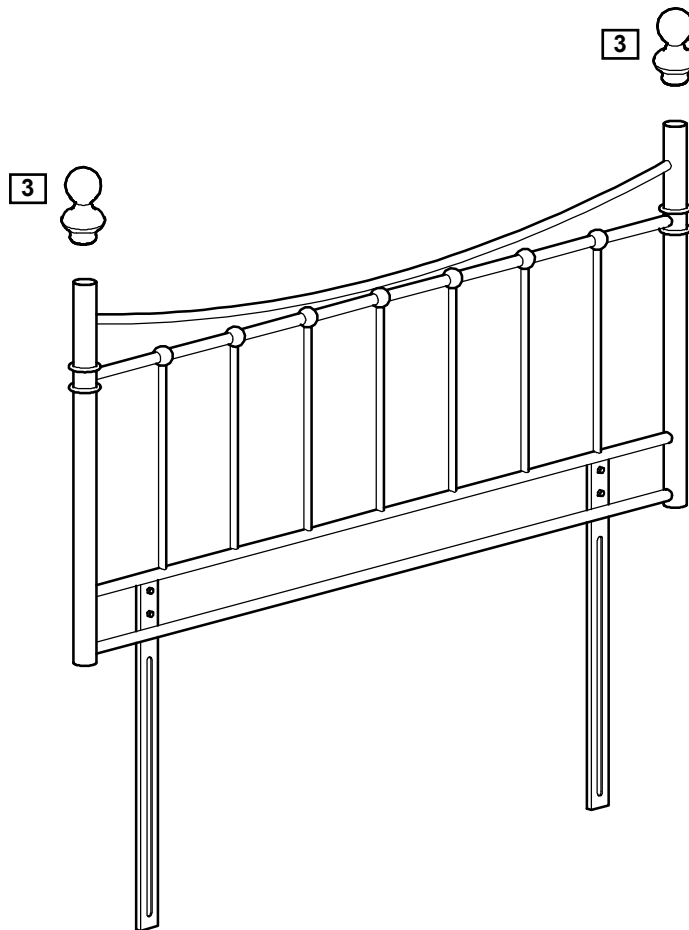

If you need help or have damaged or missing parts, call the **Customer Helpline:**
Argos = 0345 6400800