

Canon

SPEEDLITE
470EX-AI



**INSTRUCTION
MANUAL**

Introduction

The Canon Speedlite 470EX-AI is an EOS-dedicated external Speedlite, compatible with E-TTL II/E-TTL autoflash systems. The Speedlite can be used as an on-camera flash that attaches to the hot shoe of the camera (normal flash photography), and as a receiver unit during optical transmission wireless flash photography. Note that, during normal flash photography, the Speedlite can be used for AI bounce flash photography.

Before Starting to Shoot, Be Sure to Read the Following

To avoid botched pictures and accidents, first read the “Safety Precautions” (pages 8-9). Also, read this manual carefully to ensure that you use the product correctly.

Read This Instruction Manual while also Referring to Your Camera’s Instruction Manual

Before using the product, read this Instruction Manual and your camera’s Instruction Manual to familiarize yourself with their operations. Be sure to store this manual safely, too, so that you can refer to it again when necessary.

Using the Speedlite with a Camera

- **Using with an EOS DIGITAL camera (Type-A camera)**

You can use the Speedlite for easy flash photography using autoflash control in the same way as a camera’s built-in flash.

- **Using with an EOS film camera**

- **An EOS camera with E-TTL II/E-TTL autoflash metering system (Type-A camera)**

You can use the Speedlite for easy flash photography using autoflash control in the same way as a camera’s built-in flash.

- **An EOS camera with TTL autoflash metering system (Type-B camera)**

See page 110.













* This Instruction Manual assumes that the Speedlite is used with a Type-A camera.

Chapters





	Introduction	2
1	Getting Started and Basic Operations Preparing for flash photography and basic flash photography	17
2	Advanced Flash Photography Advanced shooting utilizing the flash functions	29
3	Bounce Flash Photography Flash photography using the AI bounce flash functions and bounce adapter	41
4	Setting Flash Functions with Camera Controls Setting the flash functions from the camera's menu screen	65
5	Wireless Flash Photography: Optical Transmission Wireless (receiver) flash photography using optical transmission	71
6	Customizing the Speedlite Customizing with Custom Functions and Personal Functions	81
7	Reference System map, Troubleshooting guide, Using with a type-B camera	93

Conventions Used in this Manual

Icons in this Manual



-  : Indicates the Select dial.
- <ZOOM> <MODE>** :  Indicates the top, bottom, left, and right buttons of the cross keys.
-     :  Indicates the top, bottom, left, and right buttons of the cross keys.
-  : Indicates the Select/Set button.
-   : Indicates that the respective function remains active for approx. 12 sec. or 16 sec. after you let go of the button.
- (p.**)
-  : Warning to prevent shooting problems.
-  : Supplemental information.





Basic Assumptions

- The operation procedures assume that the Speedlite is attached to the camera and that both are turned on.
- The icons used for buttons, dials, and symbols in the text match the icons found on the Speedlite and the camera.
- The selection operation performed when setting a function basically describes selecting a function by turning . A selection can also be made by pressing the top, bottom, left, and right (**<ZOOM> <MODE>**  buttons) of the  cross keys.
- Pressing the  button returns the display to the previous screen.
- The operation procedures assume that the Custom Functions and Personal Functions of the Speedlite, and the menu and Custom Functions of the camera are at their default settings.
- All figures such as the number of flashes are based on the use of four AA/LR6 alkaline batteries and Canon's testing standards.

 In this manual, the words “master” and “slave” used in previous manuals have all been replaced by the words “sender” and “receiver” respectively. Read the words “sender” and “receiver” in this manual for the above meanings as necessary.

Contents

Introduction	2
Chapters	3
Conventions Used in this Manual	4
Contents.....	5
Index to Features	7
Safety Precautions.....	8
Nomenclature.....	10
1 Getting Started and Basic Operations	17
Installing the Batteries.....	18
Attaching and Detaching the Speedlite to and from the Camera....	20
Turning on the Power.....	21
ETTL : Fully Automatic Flash Photography	24
E-TTL II/E-TTL Autoflash by Shooting Mode	25
2 Advanced Flash Photography	29
 Flash Exposure Compensation	30
FEL: FE Lock.....	31
 High-speed sync	32
 Second-curtain sync.....	33
ZOOM : Setting the Flash Coverage	34
M : Manual Flash	36
Modeling Flash.....	38
Clearing Speedlite Settings.....	40

3	Bounce Flash Photography	41
	AI.B AI Bounce Flash	42
	AI.B-F AI.B Full-Auto.....	46
	AI.B-F AI.B Full-Auto Shooting	48
	AI.B-S AI.B Semi-Auto Shooting	56
	 Manual Bounce Flash Photography	61
	 Combined Use with the Bounce Adapter	63
4	Setting Flash Functions with Camera Controls	65
	Flash Control from the Camera's Menu Screen	66
5	Wireless Flash Photography: Optical Transmission	71
	 Optical Transmission Wireless Flash Photography.....	72
	Wireless Settings.....	74
	ETTL : Fully Automatic Wireless Flash Photography.....	76
	INDIVIDUAL RECVR Manual Flash Setting on a Receiver Unit	79
6	Customizing the Speedlite	81
	C.Fn / P.Fn : Setting Custom and Personal Functions.....	82
	C.Fn : Setting Custom Functions.....	85
	P.Fn : Setting Personal Functions.....	88
7	Reference	93
	470EX-AI System	94
	 Flash Firing Restrictions due to Temperature Increase	96
	Troubleshooting Guide	98
	Specifications	105
	Using with a Type-B Camera	110
	Index.....	113

Index to Features

Power Source

- Batteries → p.18
- Firing interval/count → p.18
- Power ON/OFF → p.21
- Flash ready → p.21
- Quick flash → p.21
- Auto power off → p.22

Operations

- Attaching and detaching the Speedlite → p.20
- Lock function → p.22
- LCD panel illumination → p.22

Normal Flash Photography

- E-TTL autoflash → p.24
- Autoflash by shooting mode → p.25
- Manual flash → p.36
- Metered manual flash → p.37
- TTL autoflash → p.110

Functions

- Flash exposure compensation → p.30
- FE lock → p.31
- High-speed sync → p.32
- Second-curtain sync → p.33
- Modeling flash → p.38
- AF-assist beam → p.27

- Flash coverage → p.34
 - Wide panel → p.35
- Clearing settings (Reverting to defaults) → p.40
- Flash function settings → p.65
- Flash firing restriction → p.96
- Type-B camera → p.110

Bounce Flash Photography

- AI.B full-auto → p.43
- AI.B semi-auto → p.45
- Manual bounce → p.61
- Bounce adapter → p.63

Optical Transmission Wireless Flash Photography

- E-TTL autoflash → p.76
- Memory function → p.75
- Individual receiver → p.79

Customization

- Custom Functions (C.Fn) → p.85
- Personal Functions (P.Fn) → p.88
- Clear all → p.84

Safety Precautions

The following precautions are provided to prevent harm or injury to yourself and others. Make sure to thoroughly understand and follow these precautions before using the product.

If you experience any malfunctions, problems, or damage to the product, contact the nearest Canon Service Center or the dealer from whom you purchased the product.



Warnings: Follow the warnings below. Otherwise, death or serious injuries may result.

- To prevent fire, excessive heat, chemical leakage, explosions, and electrical shock, follow the safeguards below:
 - Do not insert any foreign metallic objects into the electrical contacts of the product, accessories, connecting cables, etc.
 - Do not use any batteries, power sources, or accessories not specified in the Instruction Manual. Do not use any deformed or modified batteries, or the product if it is damaged.
 - Do not short-circuit, disassemble, or modify the product or batteries. Do not apply heat or solder to the batteries. Do not expose the batteries to fire or water. Do not subject the batteries to strong physical shock.
 - Do not insert any battery's plus and minus ends incorrectly, or mix new batteries with used ones or batteries of different type.
- Do not use the product in locations where there is flammable gas. This is to prevent an explosion or a fire.
- Do not fire the flash at anyone driving a car or other vehicle. It may cause an accident.
- Do not disassemble or modify the equipment. High-voltage internal parts may cause electrical shock.
- If you drop the equipment and the casing breaks open to expose the internal parts, do not touch the exposed parts. There is a possibility of an electrical shock.
- Do not store the product in dusty or humid places or location with lots of oil smoke. This is to prevent a fire or electrical shock.
- Before using this product inside an airplane or hospital, check if it is allowed. Electromagnetic waves emitted by the product may interfere with the plane's instruments or the hospital's medical equipment.
- If a battery leaks, changes color, deforms, or emits smoke or fumes, remove it immediately. Be careful not to get burned in the process. It may cause a fire, electrical shock or burns if you keep using it.
- Keep the batteries and other accessories out of the reach of children and infants. If a child or infant swallows a battery or accessory, consult a physician immediately. (Battery chemicals may harm the stomach and intestines.)
- Be careful not to get the product wet. If you drop the product in the water or if water or metal get inside the product, promptly remove the batteries. This is to prevent fire, electrical shock, and burns.
- Do not cover or wrap the product with a cloth. Doing so may trap heat within and cause the casing to deform or catch fire.

- Keep the equipment out of the reach of children and infants, including when in use. Straps or cords may accidentally cause choking, electrical shock, or injury. Choking or injury may also occur if a child or infant accidentally swallows a part or accessory. If a child or infant swallows a part or accessory, consult a physician immediately.
- When the equipment is not in use, make sure to remove the batteries, and disconnect the external power source and cable from the equipment before storing. This is to prevent electrical shock, excessive heat, fire, or corrosion.
- Prevent any battery leakage from contacting your eyes, skin, and clothing. It can cause blindness or skin problems. If the battery leakage comes in contact with your eyes, skin, or clothing, flush the affected area with lots of clean water without rubbing it. See a physician immediately.
- Do not use paint thinner, benzene, or other organic solvents to clean the product. Doing so may cause fire or a health hazard.



Cautions: Follow the cautions below. Otherwise physical injury or property damage may result.

- When the product is not in use for a prolonged period, make sure to remove the batteries before storing. This is to prevent malfunction or corrosion.
- When disposing of a battery, insulate the electrical contacts with tape. Contact with other metallic objects or batteries may cause a fire or an explosion.
- Do not use, store, or leave the product in a vehicle in the direct sunlight or with a high interior temperature, or near a high-temperature object. The product may become hot and cause burns if touched. Doing so may also cause battery heat generation, breakage, leakage, and the like.
- Do not fire the flash with the flash head (light-emitting unit) in contact with a human body or any object. Doing so may result in the risk of burns and fire.
- Before performing AI bounce flash photography, be sure to warn people nearby. The flash head may move automatically and fire without warning.
- Do not fire the flash near the eyes. It may hurt the eyes.
- Do not leave the product in a low-temperature environment for an extended period of time. The product will become cold and may cause injury when touched.
- Do not directly touch any part of the product that becomes hot. Extended contact on the skin may result in low temperature contact burns.
- If you replace the batteries after continually firing, the batteries may be hot. Be careful not to get burned in the process. It may cause a skin burn.

Nomenclature

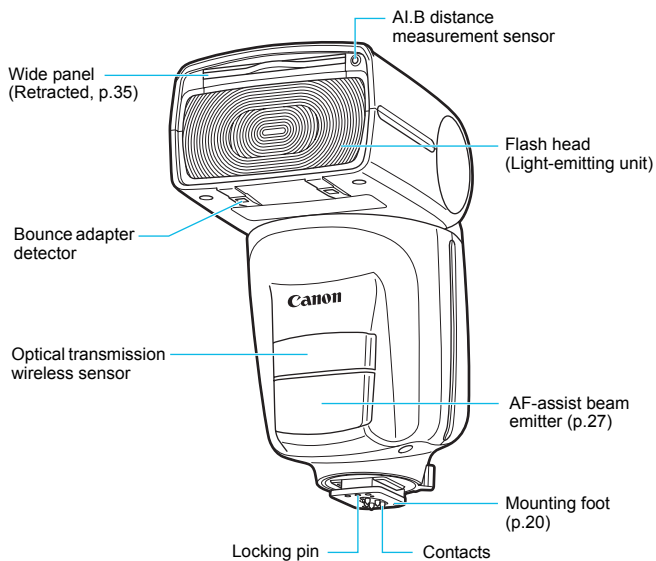

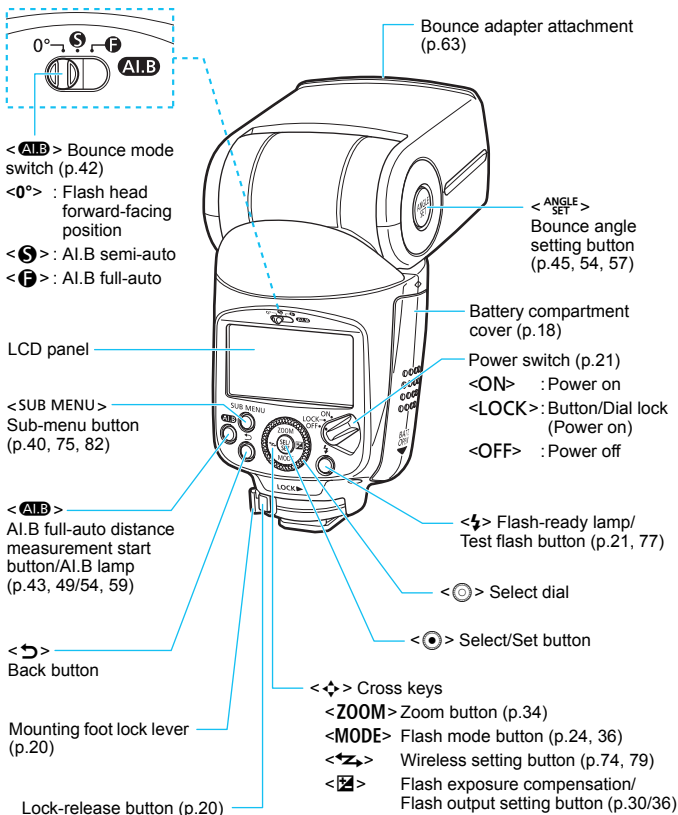

LCD Panel

E-TTL II/E-TTL Autoflash (p.24)

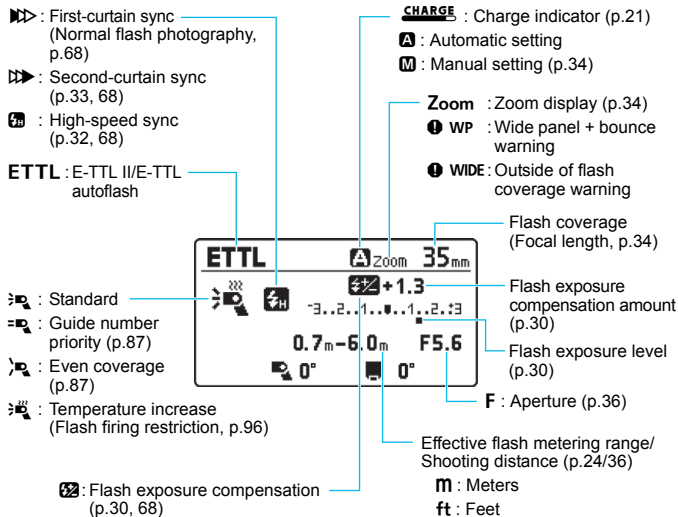

- The displays shown are examples. The display will show only the settings currently applied.
- When a button or dial is operated, the LCD panel illuminates (p.22).

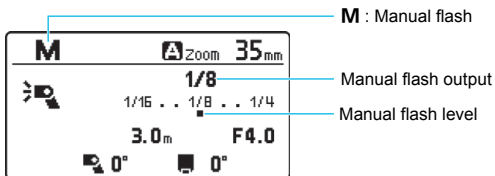
Manual Flash (p.36)**Optical Transmission Wireless Shooting** (p.71)

● Receiver unit

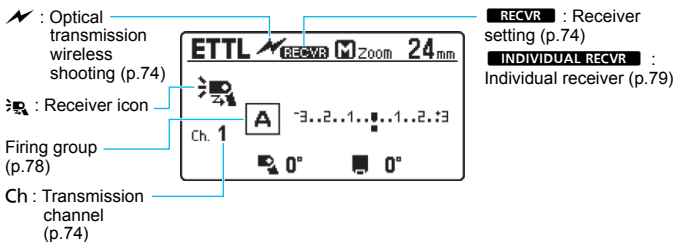

Bounce Shooting (p.41)

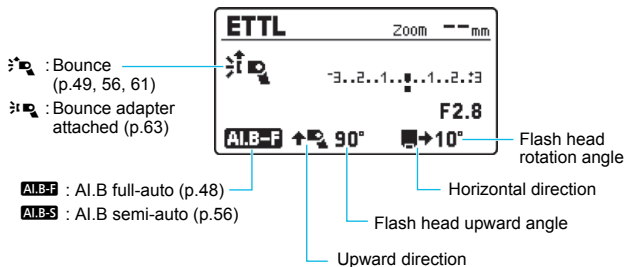

- The rotation angle of the flash head is displayed in 5 increments.
- If the camera's orientation is horizontal during AI.B full-auto shooting, the bounce angle in the upward direction is displayed up to 180°.

Accessories Provided

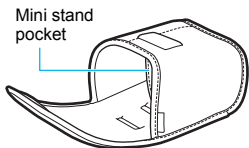

Speedlite case

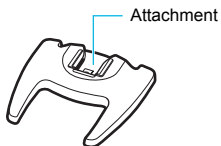

Mini stand
(p.73)



Bounce adapter
SBA-E4
(p.63)

1

Getting Started and Basic Operations

This chapter describes the preparations before starting flash photography and the basic shooting operations.

Cautions for firing continuous flash

- To avoid degrading and damaging the flash head due to overheating, limit firing the flash continuously at full output up to 30 times. After firing the flash continuously at full output for 30 times, allow a rest time of at least 10 min.
- If you fire the flash continuously at full output for the above listed number of times, and then fire the flash again repeatedly at short intervals, the safety function may activate and restrict flash firing. With flash firing restriction level 1, the firing interval is automatically set to approx. 8 sec. If this happens, allow a rest time of at least 40 min.
- For details, see “Flash Firing Restriction due to Temperature Increase” on page 96.

 When you are not performing bounce flash photography, set the <A.I.B> bounce mode switch to the <0> position (p.11). For more information on bounce flash photography, see Chapter 3 “Bounce Flash Photography” (p.41).

Installing the Batteries

Install four AA/R6 batteries for power supply.

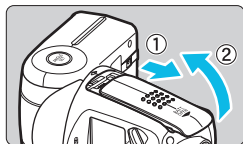

1 Open the cover.

- Slide the battery compartment cover down, then open the battery compartment cover.

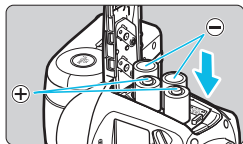

2 Install the batteries.

- Make sure the “+” and “-” electrical contacts are correctly oriented as shown in the battery compartment.
- The grooves on the side surfaces inside the battery compartment indicate “-”. This is convenient when replacing the batteries in a dark place.

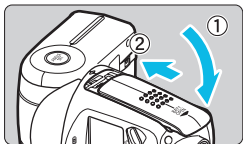

3 Close the cover.

- Close the battery compartment cover, then slide it up by following the procedure of step 1 in reverse.

Firing Interval and Number of Flashes

Firing Interval		Number of Flashes
Quick Flash	Normal Flash	
Approx. 0.1 to 3.9 seconds	Approx. 0.1 to 5.5 seconds	Approx. 115 to 800 times

- Based on new AA/LR6 alkaline batteries and Canon's testing standards.
- The Quick flash function enables flash photography before the flash is fully charged (p.21).

 **CAUTION**

- **Do not use “AA/R6 lithium batteries”.**

Note that certain AA/R6 lithium batteries may become extremely hot in rare cases during use. Due to safety reasons, do not use “AA/R6 lithium batteries”.

- **When performing continuous flash, do not touch the flash head, batteries, or the area near the battery compartment.**

When continuous flash or modeling flash is repeatedly fired at short intervals, do not touch the flash head, batteries, or the area near the battery compartment. The flash head, batteries, and area near the battery compartment may become hot, resulting in the risk of burn.

- **Do not use the Speedlite while touching the same part for a long period of time.**

Even if the product does not feel too hot, prolonged contact with the same body part may cause skin redness or blistering due to low-temperature contact burns. Using a tripod is recommended in very hot places or for people with circulation problems or very sensitive skin.



Using AA/R6 batteries other than the alkaline type may cause contact failure due to the irregular shape of the battery contacts.



- When  is displayed or the LCD panel display turns off during recharging, replace the batteries with new ones.
- Use a new set of four batteries of the same brand. When replacing the batteries, replace all four at one time.
- AA/HR6 Ni-MH batteries can also be used.

Attaching and Detaching the Speedlite to and from the Camera

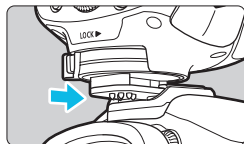

1 Attach the Speedlite.

- Slip the Speedlite's mounting foot **all the way** into the camera's hot shoe.

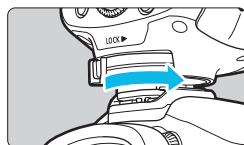

2 Secure the Speedlite.

- Slide the mounting foot lock lever to the right.
- ▶ When the lock lever clicks in place, it is locked.

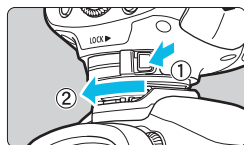

3 Detach the Speedlite.

- While pressing the lock-release button, slide the lock lever to the left and detach the Speedlite from the camera.

 Be sure to turn off the Speedlite before attaching or detaching it.

Turning on the Power

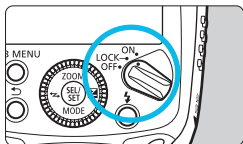

1 Set the power switch to <ON>.

- ▶ The flash recharge starts.
- ▶ During recharging, < **CHARGE** > is displayed on the LCD panel. When flash recharge is complete, this indicator disappears.

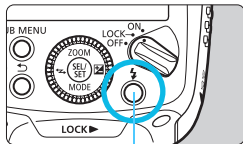

Flash-ready lamp
(Test flash button)

2 Check that the flash is ready.

- The status of the flash-ready lamp changes from **off** to **green** (Quick flash ready) to **red** (fully charged).
- You can press the test flash button (flash-ready lamp) to fire a test flash.

Quick Flash Function

The Quick flash function enables flash photography when the flash-ready lamp is lit green (before the flash is fully charged). Quick flash is available regardless of the camera's drive mode setting. Although the flash output will be approx. 1/2 to 1/6 of the full output, it is useful for shooting with a shorter firing interval.

During manual flash photography, this function is available when the flash output is set to 1/4 to 1/128. Note that you cannot use Quick flash with the receiver unit during optical transmission wireless shooting.



- When the power is turned on, the flash head may automatically operate (rotate).
- When Quick flash is fired during continuous shooting, underexposure may occur since the flash output decreases.
- When the 4 / 6 / 8 / 10 / 16 timer of the camera is operating, a test flash cannot be performed.

Auto Power Off Function

To save battery power, the power will turn off automatically after approx. 90 sec. of idle use. To turn on the Speedlite again, press the camera's shutter button halfway or press the test flash button (flash-ready lamp). When set as the receiver unit for optical transmission wireless flash shooting (p.72), the time until auto power off takes effect is approx. 60 min.

Lock Function

By setting the power switch to <LOCK>, you can disable the flash's button and dial operations (except the <ALB> switch operation). It is useful when you want to prevent the flash function settings from being accidentally changed after you set them.

If you operate a button or dial, <LOCKED> is displayed on the LCD panel.

LCD Panel Illumination

When a button or dial is operated, the LCD panel illuminates for approx. 12 sec. (12).

During normal flash photography, the LCD panel illuminates in green. When set as a receiver unit during optical transmission wireless shooting, the LCD panel illuminates in orange.



- The flash settings will remain in effect even after the power is turned off. To retain the settings when replacing the batteries, replace the batteries after turning off the power switch.
- You can fire a test flash while the power switch is set to the <LOCK> position. Also, when a button or dial is operated, the LCD panel illuminates.
- Auto power off can be disabled (C.Fn-01, p.85).
- When set as a receiver unit, you can change the time until the receiver unit's auto power off takes effect (C.Fn-10, p.86).
- You can change the setting of the LCD panel illumination (C.Fn-22, p.87).
- You can change the color of the LCD panel illumination (P.Fn-02/03, p.88).
- You can disable Quick flash (P.Fn-05, p.89).

ETTL: Fully Automatic Flash Photography

When you set the camera's shooting mode to <P> (Program AE) or a fully automatic mode, you can shoot in E-TTL II/E-TTL fully automatic flash mode.

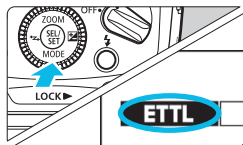

1 Set the flash mode to <ETTL>.

- Press the <MODE> button of the <◀▶> cross keys.
- Turn <⊙> to select <ETTL>, then press <⊙>.



2 Focus on the subject.

- Press the shutter button halfway to focus.
- ▶ The shutter speed and aperture are displayed in the viewfinder.
- Check that <⚡> is lit in the viewfinder.

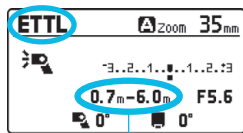

Effective flash metering range

3 Take the picture.

- Check that the subject is in the effective flash metering range.
- When you press the shutter button completely, the flash will fire and the picture will be taken.

- If the subject is dark (underexposed) when you check the shot image, move closer to the subject and shoot again. You can also increase the ISO speed when using a digital camera.
- “Fully automatic” refers to <A+>, <□>, and <CA> shooting modes.
- Even when attached to a camera that supports the E-TTL II autoflash system, <ETTL> is displayed on the LCD panel.

E-TTL II/E-TTL Autoflash by Shooting Mode

Simply by setting the camera's shooting mode to <**Tv**> (shutter-priority AE), <**Av**> (aperture-priority AE), or <**M**> (manual exposure), you can execute E-TTL II/E-TTL autoflash suitable for each shooting mode.

Tv	Select this mode when you want to set the shutter speed manually. The camera will then automatically set the aperture matching the shutter speed to obtain the standard exposure based on the metering of the camera. <ul style="list-style-type: none">• If the aperture value blinks, it means that the background exposure will be underexposed or overexposed. Adjust the shutter speed until the aperture value stops blinking.
Av	Select this mode when you want to set the aperture manually. The camera will then automatically set the shutter speed, matching the aperture to obtain the standard exposure based on the metering of the camera. For low-light scenes, a slow sync speed will be used to obtain the standard exposure for both the main subject and background. The standard exposure for the main subject is obtained with the flash light, while the standard exposure for the background is obtained with a long exposure using a slow shutter speed. <ul style="list-style-type: none">• Since a slow shutter speed will be used for low-light scenes, using a tripod is recommended.• If the shutter speed blinks, it means that the background exposure will be underexposed or overexposed. Adjust the aperture until the shutter speed stops blinking.
M	Select this mode if you want to set both the shutter speed and aperture manually. Standard exposure of the main subject is obtained with the flash light. The exposure of the background changes according to the shutter speed and aperture combination you set.

- If you use the <**DEP**> or <**A-DEP**> shooting mode, the result will be the same as using the <**P**> (Program AE) mode.

Flash Sync Speeds and Apertures by Shooting Mode

	Shutter Speed	Aperture
P	Automatically set (1/X sec. to 1/60 sec.)	Automatically set
Tv	Manually set (1/X sec. to 30 sec.)	Automatically set
Av	Automatically set (1/X sec. to 30 sec.)	Manually set
M	Manually set (1/X sec. to 30 sec., Bulb)	Manually set

- 1/X sec. is the camera's maximum flash sync speed.

Auto Zoom Adjustment to Image Sensor Size

EOS DIGITAL cameras have three sizes of image sensors, and the effective shooting angle of view of the attached lens varies depending on the size of image sensor. 470EX-AI automatically recognizes the image sensor size of the EOS DIGITAL camera and automatically sets the flash coverage that is ideal for the effective shooting angle of view of a lens for the focal length range of 24-105mm.

Color Temperature Information Transmission

This function adjusts the white balance depending on the color temperature of the flash light by transmitting the color temperature information to the EOS DIGITAL camera when the flash fires. When you set the camera's white balance to <AWB>, <AWBw>, or <⚡>, the function is enabled automatically.

Refer to the specifications in your camera's Instruction Manual to find out if it is compatible with this function.

Bounce Function

See Chapter 3, "Bounce Flash Photography" (p.41-64).



When the <ALB> bounce mode switch is set to the <0°> position and the flash head is facing a direction other than straight forward, the <ALB> lamp blinks. Pressing the shutter button halfway automatically returns the position of the flash head to the forward-facing position. (The <ALB> lamp turns off.)

AF-Assist Beam

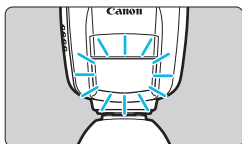

When it is difficult to autofocus on the subject in low-light or when contrast is low during viewfinder shooting, the infrared AF-assist beam built into the flash is automatically emitted to help autofocus.

The AF-assist beam supports most of the EOS cameras' AF points. The AF-assist beam covers the angle of view of 28 mm or longer lens focal length, and its effective range (at 28 mm focal length) is approx. 0.7 - 10 m/2.3 - 32.8 ft. at the center in the viewfinder and approx. 1 - 5 m/3.3 - 16.4 ft. at the periphery (AF points other than the center AF point).

 If a peripheral AF point is selected, or a wide-angle or telephoto lens is used, achieving focus may be difficult with an EOS-dedicated, external Speedlite's AF-assist beam. In such a case, use the center AF point or an AF point close to the center.

-  ● During Live View shooting, the AF-assist beam is emitted even when the AF method is set to **[Quick mode]**.
- AF-assist beam firing can be disabled (C.Fn-08, p.86).
 - The AF-assist beam type that uses intermittent flashes (a series of small flashes) can be emitted (P.Fn-04, p.89).

2

Advanced Flash Photography

This chapter describes advanced shooting operations utilizing the flash functions.





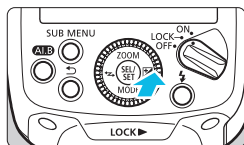

- When the camera's shooting mode is set to a fully automatic mode or a Basic Zone mode, the operations in this chapter are not available. Set the camera's shooting mode to <P/Tv/**Av**/M/bulb(B)> (Creative Zone mode).
- When you are not performing bounce flash photography, set the <ALB> bounce mode switch to the <0°> position (p.11). For more information on bounce flash photography, see Chapter 3 "Bounce Flash Photography" (p.41).

Flash Exposure Compensation

With a similar procedure as exposure compensation, you can adjust the flash output. The flash exposure compensation amount can be set up to ± 3 stops in 1/3-stop increments.





1 Press the button.

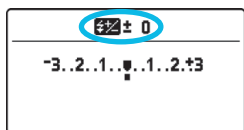

- Press the  button of the  cross keys.
- You can also select the flash exposure compensation by pressing  and turning .

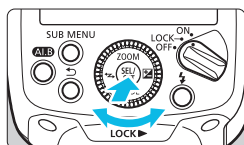

2 Set the flash exposure compensation amount.

- Turn  to set the flash exposure compensation amount, then press .
- ▶ The flash exposure compensation amount is set.
- “0.3” indicates 1/3 stop and “0.7” indicates 2/3 stops.
- To cancel flash exposure compensation, return the compensation amount to ± 0 .



- Generally, set an increased exposure compensation for bright subjects and set a decreased exposure compensation for dark subjects.
- If the camera's exposure compensation is set in 1/2-stop increments, flash exposure compensation will be up to ± 3 stops in 1/2-stop increments.
- When the flash exposure compensation is set on both the flash and the camera, priority is given to the flash setting.
- Without pressing the  button of the  cross keys, you can directly turn  and set the amount of flash exposure compensation (C.Fn-13, p.86).

FEL: FE Lock

The FE (Flash Exposure) lock locks the correct flash exposure setting for any part of the subject.

With <ETTL> displayed on the LCD panel, press the camera's <M-Fn> button. For cameras without a <M-Fn> button, press the <★> (AE lock) or <FEL> button.

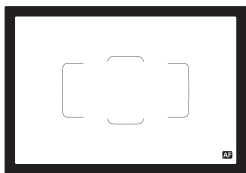

1 Focus on the subject.

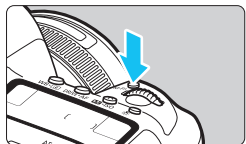

2 Press the <M-Fn> button (ⓘ16).

- With the subject at the center of the viewfinder, press the camera's <M-Fn> button.
- ▶ The Speedlite will fire a preflash and the required flash output for the subject is retained in memory.
- ▶ “FEL” will be displayed in the viewfinder for approx. 0.5 sec.
- Each time you press the <M-Fn> button, a preflash will be fired and the new flash output required at that time is retained in memory.



- If a correct exposure cannot be obtained when FE lock is performed, <⚡> blinks in the viewfinder. Move closer to the subject or open the aperture, and perform FE lock again. You can also set a higher ISO speed and perform FE lock again when using a digital camera.
- If the target subject is too small in the viewfinder, FE lock may not be effective.

High-speed Sync

With high-speed sync, you can shoot with a flash even at shutter speeds that exceed the maximum flash sync shutter speed. This is effective when you want to shoot in the aperture-priority AE <Av> mode (open aperture) with background blur in locations such as outdoors in daylight.

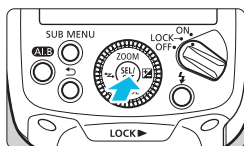

1 Press <⊙>.

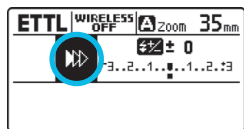

2 Select the item in the illustration.

- Turn <⊙> to select the item in the illustration, then press <⊙>.

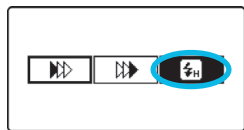

3 Select <⚡H>.

- Turn <⊙> to select <⚡H>, then press <⊙>.
- Check that <⚡H> is lit in the viewfinder, then take the picture.

 With high-speed sync, the faster the shutter speed, the lower the guide number becomes. You can check the effective flash metering range on the LCD panel.

- When the shutter speed is less than or equal to the maximum flash sync shutter speed, <⚡H> is not displayed in the viewfinder.
- To return flash firing to normal, select <⏪> (first-curtain sync) in step 3. (<⏪> will not be displayed on the LCD panel after you perform this setting.)

▶▶ Second-curtain Sync

Shooting with a slow shutter speed and second-curtain sync captures the trail of the light sources of a moving subject, such as car lights, in a natural way. The flash fires right before the exposure finishes (shutter closes).

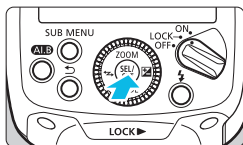

1 Press <⊙>.

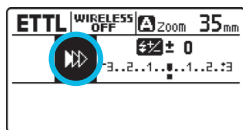

2 Select the item in the illustration.

- Turn <⊙> to select the item in the illustration, then press <⊙>.

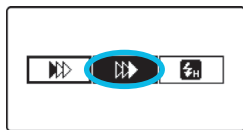

3 Select <▶▶>.

- Turn <⊙> to select <▶▶>, then press <⊙>.



- The second-curtain sync works well when the camera's shooting mode is set to <bulb(B)> (bulb shooting).
- When the flash mode is set to <ETTL>, the flash fires twice. The first flash is a preflash to determine the flash output. It is not a malfunction.
- Second-curtain sync is not available during wireless flash photography.
- To return flash firing to normal, select <▶▶> (first-curtain sync) in step 3. (<▶▶> will not be displayed on the LCD panel after you perform this setting.)

ZOOM: Setting the Flash Coverage

Flash coverage (the range covered by the flash light) can be set automatically or manually. With **<A>** (automatic setting), the flash coverage is adjusted automatically according to the focal length (shooting angle of view) of the lens in use and the image sensor size (p.26). With **<M>** (manual setting), you can manually set flash coverage in the range of 24 mm to 105 mm.

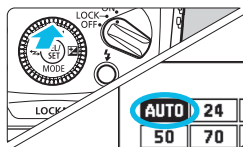

1 Press the **<ZOOM>** button.

- Press the **<ZOOM>** button of the **<⬆️⬇️⬅️⬇️>** cross keys.

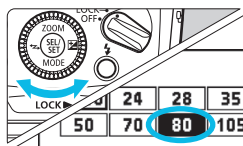

2 Set the flash coverage.

- To set the flash coverage automatically, set **<AUTO>**. To set the flash coverage manually, select a number (indicating the focal length in mm).
- Turn **<⦿>** to select the flash coverage, then press **<⦿>**.

- When you set the flash coverage manually, set the same or a wider coverage than the angle of view for shooting to avoid darkening the periphery of the picture.
- When a lens with a focal length less than 24 mm is attached, the **<⚠️ WIDE>** warning is displayed on the LCD panel. When using a camera with the image sensor size smaller than full-frame, the **<⚠️ WIDE>** warning is displayed when the actual shooting angle of view is wider than the angle of view of a 24 mm lens.

Wide Panel

When you use the flash's built-in wide panel together with the flash, you can perform flash photography covering the angle of view of an ultra-wide angle lens with a focal length as wide as 14 mm.

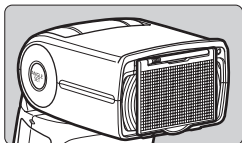
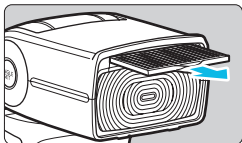

Pull out the wide panel.

- Pull out the protruding area located in the center of the wide panel.
- Fold down the wide panel.



- Since underexposure may occur, the <⚠ WP> warning is displayed on the LCD panel when using the wide panel with bounce flash.
- Do not pull out the wide panel with excessive force. Doing so may detach the wide panel from the Speedlite.
- Angle of view of EF15mm f/2.8 Fisheye or EF8-15mm f/4L Fisheye USM is not supported.
- When the wide panel is pulled out, AI.B full-auto shooting (p.48) is not possible.



- The flash coverage is set automatically when using the wide panel. You cannot change the setting.
- You can perform flash photography with the wide panel even when the camera's shooting mode is set to a fully automatic mode or a Basic Zone mode.

M: Manual Flash

You can set the flash output from 1/1 full output to 1/128 power in 1/3-step increments.

Use a flash meter (commercially-available) to determine the required flash output to obtain a correct flash exposure. Setting the camera's shooting mode to <Av> or <M> is recommended.

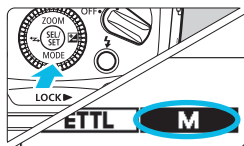

1 Set the flash mode to <M>.

- Press the <MODE> button of the <⬇> cross keys.
- Turn <⊙> to select <M>, then press <⊙>.

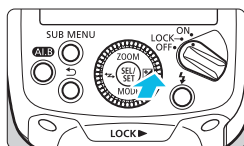

2 Set the flash output.

- Press the <⊞> button of the <⬇> cross keys.
- Turn <⊙> to set the flash output, then press <⊙>.

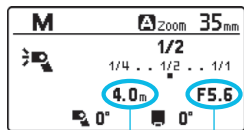
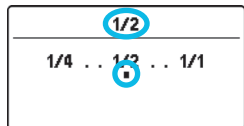

Shooting distance Aperture

- When you press the camera's shutter button halfway, an approximate indication of the effective shooting distance and the aperture value are displayed.

- For guide number details with manual flash, see page 109.
- Without pressing the <⊞> button of the <⬇> cross keys, you can directly turn <⊙> and set the flash output (C.Fn-13, p.86).

Metered Manual Flash Exposure

When using an EOS-1D series camera, the flash exposure level can be manually set before shooting. This is effective when you are close to the subject. Use an 18% gray reflector (commercially available) and shoot as follows.

1 Configure the camera and Speedlite settings.

- Set the camera shooting mode to <M> or <Av>.
- Set the Speedlite's flash mode to <M>.

2 Focus on the subject.

- Focus manually.

3 Set up an 18% gray reflector.

- Place the gray reflector at the subject's position.
- Aim the camera so that the entire spot metering circle within the viewfinder center is over the gray reflector.

4 Press the <M-Fn>, <✳>, or <FEL> button (ⓘ16).

- ▶ The Speedlite will fire a preflash and the required flash output for the correct flash exposure is retained in memory.
- ▶ On the right side of the viewfinder, the exposure level indicator will show the flash exposure level against the standard exposure.

5 Set the flash exposure level.

- Adjust the Speedlite's manual flash output and the aperture so that the flash exposure level aligns with the standard exposure index.

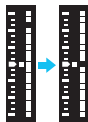

6 Take the picture.

- Remove the gray reflector and take the picture.



Metered manual flash exposure is available only with EOS-1D series cameras.

Modeling Flash

When the camera's depth-of-field preview button is pressed, the flash fires continuously for approx. 1 sec. This feature is called "modeling flash". This is useful for checking shadows cast on the subject by the flash light.

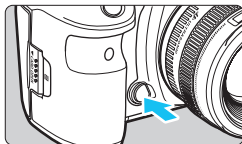

Press the depth-of-field preview button on the camera.

- ▶ The flash fires continuously for approx. 1 sec.

Modeling Flash in AI.B Full-Auto Mode

When an EOS DIGITAL camera released in or after the second half of 2017 (excluding some cameras, p.46) is used and the <AI.B> switch is set to <F> full auto, the camera's depth-of-field preview button functions as an AI.B full-auto distance measurement start button. With this setting, you can fire a modeling flash using the test flash button on the flash in AI.B full-auto shooting if the Custom function C.Fn-02 is set to 1 or 2 (p.85).



- To avoid degrading and damaging the flash head due to overheating, limit firing the modeling flash up to 20 times. After firing modeling flash for 20 times, allow a rest time of at least 10 min.
- If you fire the modeling flash for the above listed number of times, and then fire the flash again repeatedly at short intervals, the safety function may activate and restrict flash firing. With flash firing restriction level 1, the firing interval is automatically set to approx. 8 sec. If this happens, allow a rest time of at least 40 min.
- During Live View shooting, firing modeling flash (by operating the camera) is not possible.
- Modeling flash (by operating the camera) is disabled when using the flash with EOS M6, EOS M5, EOS M3, EOS M2, EOS M, EOS Elan II/ Elan II E/50/50E, EOS REBEL 2000/300, EOS REBEL G/500N, EOS REBEL K2/3000V, EOS REBEL XS N/REBEL G II/3000N/66, EOS IX, or EOS IX Lite/IX7. Set C.Fn-02 to 1 or 2 (p.85), and then fire modeling flash using the test flash button. (When using the EOS M series cameras listed above, the test flash button functions when the camera's metering timer is not active.)



You can use the test flash button to fire the modeling flash (C.Fn-02, p.85).

Clearing Speedlite Settings

You can revert the settings of the Speedlite shooting functions and wireless shooting settings to their defaults.

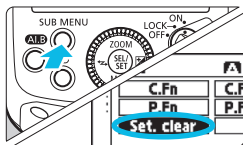

1 Display the Clear Settings screen.

- Press the <SUB MENU> button.
- Turn <ZOOM SEL SET MODE> to select <Set. clear>, then press <ZOOM SEL SET MODE>.
- ▶ A confirmation screen is displayed.

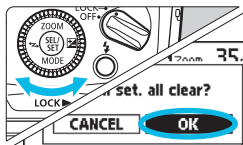

2 Clear the settings.

- Turn <ZOOM SEL SET MODE> to select <OK>, then press <ZOOM SEL SET MODE>.
- ▶ The Speedlite settings are cleared, and normal flash photography with <ETTL> flash mode will be set.

Even when the settings have been cleared, the transmission channel for optical transmission wireless receiver unit as well as the settings of the Custom Functions (C.Fn) and Personal Functions (P.Fn) will not be cleared.

3

Bounce Flash Photography

This chapter describes functions related to the bounce flash function, such as flash photography that uses the AI.B full-auto function, AI.B semi-auto function, manual bounce, and bounce adapter.

Cautions for the AI Bounce Flash Function

During AI.B full-auto and AI.B semi-auto shooting, the flash head moves and fires automatically. The flash head may fire in an unintended direction. Before performing AI bounce flash photography, be sure to warn those around you. Additionally, when you want to perform AI bounce flash photography, follow the precautions below.

- Make sure your eyes are not close to the flash head.
- The flash head may come in contact with objects. Make sure your face, head, and the like are not close to the flash head.
- The flash head moves. Be sure to hold the camera securely.
- Do not allow your hair or the like to get entangled with the flash head.
- Be careful of the orientation of the flash head in low angle shooting.

AI.B AI Bounce Flash

By pointing the flash head toward a ceiling, you can utilize the reflection of the flash light off the surface for flash photography, making it possible to soften the shadows of the subject for a more natural-looking shot.

This shooting technique is called “Bounce flash photography”.

Bounce flash photography allows you to get a more natural-looking shot compared to techniques that light the subject directly with the flash light. Shooting with the appropriate exposure, however, may require some knowledge and experience.

This Speedlite comes with an “AI bounce (AI.B) flash function” that enables you to perform bounce flash photography automatically. There are two AI bounce flash modes: “AI.B full-auto mode” and “AI.B semi-auto mode”. With AI.B full-auto function, the camera performs the bounce flash photography automatically, requiring only simple operations.

Bounce Mode

Slide the <AI.B> bounce mode switch to switch the AI bounce flash mode.

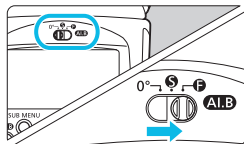

0° : Set when performing normal flash photography (not bounce flash photography).

S : Allows you to perform “**AI.B semi-auto shooting**” (p.45, 56).

F : Allows you to perform “**AI.B full-auto shooting**” (p.43, 46, 48).

- When the bounce mode is switched, the flash head automatically moves to the forward-facing position.
- When the flash head is moving, do not touch it.
- When you are to perform manual bounce flash photography, set P.Fn-09 to 1 (p.92) and set the switch to the <0°> position.

AI.B-F AI.B Full-Auto

This mode is geared for beginners. In this mode, the camera performs the bounce flash photography automatically, requiring only simple operations. When the <AI.B> AI.B full-auto distance measurement start button is pressed, the flash fires briefly (preflash) to measure the distance to the subject and the distance to the ceiling for bouncing the flash light. Based on the result of distance measurement, the orientation (bounce angle) of the flash head is automatically set.

For AI.B full-auto shooting, see pages 46-55.

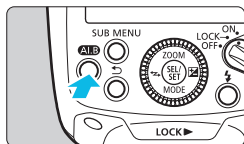

Press the <AI.B> button to perform the following operations automatically.



1. Fires the flash toward the subject.



2. Fires the flash toward the ceiling.



3. Sets the bounce angle automatically.



When using an EOS DIGITAL camera released in or after the second half of 2017 (p.46), you can perform the same distance measurement operation as described above using the camera's depth-of-field preview button.

Note if you change the orientation (position) of the camera, double-clicking the camera's shutter button (pressing the shutter button halfway two times in a row within a short period) makes the flash head move automatically, resetting the bounce angle to substantially the same angle as before you changed the orientation of the camera.

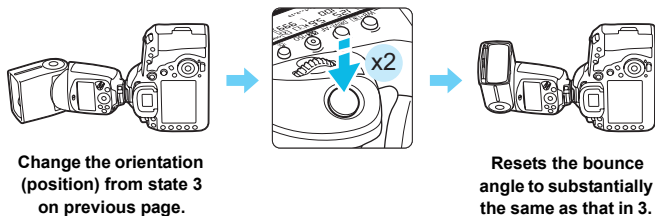

Depending on the camera used, AI.B full-auto shooting may not be available. Additionally, even if the camera supports AI.B full-auto shooting, some operations may be limited. See page 46 for details.

AI.B-S AI.B Semi-Auto

This mode is geared for intermediate and advanced photographers. You can store (register) the bounce angle in the Speedlite by pressing the $\langle \text{ANGLE}_{\text{SET}} \rangle$ button after setting the orientation (bounce angle) of the Speedlite's flash head as desired.

For AI.B semi-auto shooting, see pages 56-59.

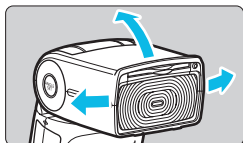

1. Set the bounce angle as desired.

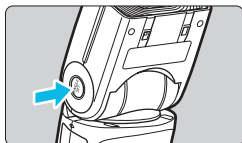

2. Press the $\langle \text{ANGLE}_{\text{SET}} \rangle$ button.

Note if you change the orientation (position) of the camera, double-clicking the camera's shutter button (pressing the shutter button halfway two times in a row within a short period) makes the flash head move automatically, resetting the bounce angle to substantially the same angle as before you changed the orientation of the camera.

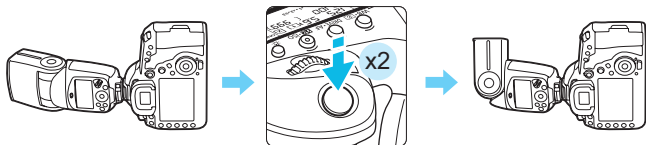

Change the orientation (position) from state 2.

Resets the bounce angle to substantially the same as that in 2.

AI.B-F AI.B Full-Auto

Depending on the camera used, AI.B (AI bounce flash) full-auto mode compatibility and some of the operations to start AI.B full-auto shooting vary (**EOS cameras released up to the first half of 2014 do not support AI.B full-auto shooting**).

During AI.B full-auto shooting, the flash fires briefly (preflash) before the image is shot to measure the distance to the subject and the distance to the ceiling for bouncing the flash light. This operation automatically sets an appropriate bounce angle for the subject.

You can perform this operation using one of the following two methods. The operating procedure differs according to the camera used.

1. Use the Speedlite's <AI.B> AI.B full-auto distance measurement start button.
2. Use the camera's depth-of-field preview button.

AI.B Full-Auto Compatible Cameras and Operation Restrictions

● EOS DIGITAL cameras released in and after the second half of 2017

You can start distance measurement for AI.B full-auto shooting using either operation 1 or 2 described above.

* While EOS REBEL T7/2000D/1500D and EOS REBEL T100/3000D/4000D, were released in or after the second half of 2017, the cameras provide the same compatibility as "EOS cameras released up to the first half of 2014" on the next page. AI.B full-auto shooting cannot be performed.



- For information on the latest cameras supporting the AI.B full-auto function, refer to the Canon Web site.
- When using an EOS DIGITAL camera released in or after the second half of 2017 not equipped with the depth-of-field preview button, you can assign the depth-of-field preview function to a button with the camera's customization features and start distance measurement for AI.B full-auto shooting (perform the same operation as 2) by pressing the button (except for the certain buttons).

● **EOS DIGITAL cameras released from the second half of 2014 up to the first half of 2017**

When using EOS-1D X Mark II, EOS 5DS/5DS R, EOS 5D Mark IV, EOS 7D Mark II, EOS 80D, EOS 77D, EOS REBEL T6S/760D, EOS REBEL T7i/800D, or EOS REBEL T6i/750D, you can perform full-auto bounce flash photography by performing operation 1. **You cannot start distance measurement operation of the AI.B full-auto shooting by operation 2.**

* While EOS REBEL T6/1300D, EOS M6, EOS M5 and EOS M3 were released in or after the second half of 2014, the cameras provide the same compatibility as “EOS cameras released up to the first half of 2014”. AI.B full-auto shooting cannot be performed.

● **EOS DIGITAL cameras released up to the first half of 2014**
AI.B full-auto shooting cannot be performed. Perform AI.B semi-auto shooting (p.56) or manual bounce flash photography (p.61).



- Do not press the <AI.B> button and then fully press the shutter button (take a shot) during the AI.B full-auto distance measurement operation. The Speedlite may be fired at full output, and accurate distance measurement operation may not be performed.
- When the camera's shooting mode is set to a mode in which the flash is not fired, or when [Flash firing] in [External Speedlite control] or [Flash control] mode (p.66) is set to [Disabled], distance measurement is not performed during AI.B full-auto shooting even if the camera's depth-of-field preview button is pressed when using an EOS DIGITAL camera released in or after the second half of 2017.
- When using an EOS DIGITAL camera released in or after the second half of 2017 and after pressing the depth-of-field button, a shot cannot be taken during distance measurement operation even when you press the shutter button completely (release lock). Perform shooting after the distance measurement operation is complete.

AI.B-F AI.B Full-Auto Shooting

Before performing AI.B (AI bounce flash) full-auto shooting, check if the camera used supports full-auto bounce flash photography (p.46).

For an overview of AI.B full-auto shooting, see page 43. Additionally, before performing AI.B full-auto shooting, review the “Safety Precautions” (p.8), “General Cautions for AI.B Full-Auto Shooting and AI.B Semi-Auto Shooting” (p.60), and the like.

Guidelines for Shooting Conditions in AI.B Full-Auto Mode

When performing AI.B full-auto shooting, perform bounce flash photography using the figure below as reference. Additionally, with the subject positioned in the center of the screen, press the <AI.B> button (to start distance measurement operation).

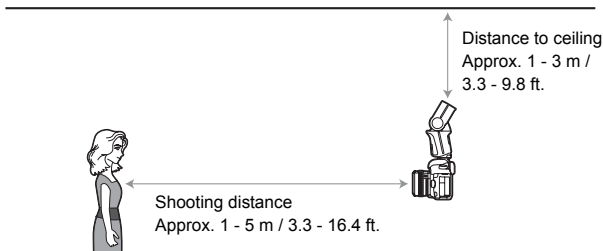

- Under conditions such as when the subject is far away, the ceiling is far away, the ceiling is a dark color, the ceiling is stepped or uneven, the camera's ISO speed setting is low, or a large aperture value is set, underexposure (insufficient exposure) is prone to occur.
- When the distance to the ceiling is approx. 7 m / 23 ft. or greater (estimate), or when the shooting angle exceeds approx. 60° upward or approx. 60° downward, the flash head automatically moves to the forward-facing position and normal flash shooting is performed without a bounce flash.

AI.B Full-Auto Shooting

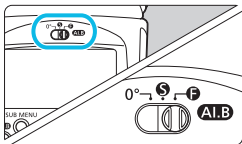

1 Set the <AI.B> switch to the <F> position (p.42).

- With the Speedlite attached to the camera, check that both the camera and the Speedlite are turned on.
- Set the <AI.B> bounce mode switch to the <F> position.
- ▶ When the flash head is not in the forward-facing position, the flash head moves and is automatically set to face forward.

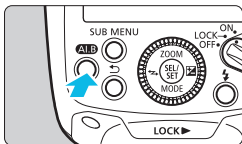

2 Press the <AI.B> button.

- Check that the <⚡> flash-ready lamp is lit.
- With the subject positioned in the screen center, press the <AI.B> button.
- The distance to the subject and the distance to the ceiling for bouncing the flash light are measured (distance measurement operation). Note that the flash fires briefly twice (preflash) during the operation.
- You can also start the distance measurement using the depth-of-field preview button, depending on the camera used (p.46).
- ▶ When the distance measurement completes, the bounce angle is automatically set.
- ▶ The Speedlite icon on the LCD panel changes to <⚡>.

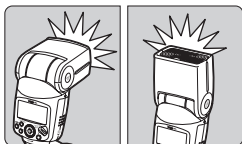

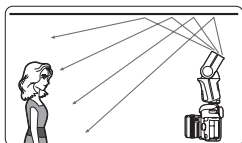

3 Take the picture.

- Focus on the subject and take the picture in the same way as with normal flash photography.
- ▶ The flash fires at the automatically set bounce angle and the picture is taken.
- Play back the image, then check the result.

- When the camera is equipped with a flash mode that disables flash firing, set the mode to one that does not disable flash firing.
- During AI.B full-auto shooting, the flash coverage is automatically set. You cannot manually change the setting.
- Even if **[Flash firing]** in the camera's menu function **[External Speedlite control]** or **[Flash control]** is set to **[Disabled]**, when you press the **<AI.B>** button, the preflash will be fired to measure the distance.

- When the distance to the subject is short, the bounce angle may be set to 90° or greater. This is a normal operation. By relaxing the angle in which the flash light hits the subject (making the incident angle shallower), you can suppress the shadow on the subject (example: the shadow beneath the face when taking a picture of a person).
- During bounce photography, the flash coverage is set to 50 mm and **<-->** is displayed.
- With the position of the flash head moved (inadvertently) after the distance measurement operation by pressing the **<AI.B>** button or the like (with the AI.B lamp blinking), if you press the shutter button halfway or press any other button on the camera, automatic correction may be performed to set the bounce angle to the position at the time when it was automatically set by the distance measurement operation. Note that when you press the shutter button completely with the AI.B lamp blinking, the Speedlite will not fire until the flash head is moved to the appropriate position.



What To Do When You Change the Camera Orientation (Position)

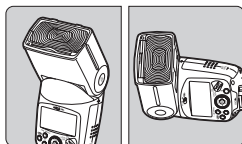
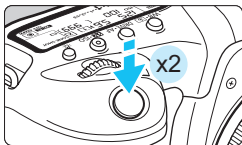

Note that if you change the orientation (position) of the camera after pressing the < AI.B > button, etc. and executing AI.B full-auto distance measurement, double-clicking the camera's shutter button (pressing the shutter button halfway two times in a row within a short period) activates the flash head to move automatically, resetting (automatically correcting) the bounce angle to substantially the same angle as before you changed the orientation (position). This function is convenient when the camera's horizontal or vertical orientation has changed.









- When a picture is taken during automatic correction of the bounce angle, the flash does not fire.
- When shooting conditions (subject, distance from subject, distance to ceiling, etc.) change, press the < AI.B > button once again to repeat the distance measurement (p.49).



You can select the method to perform the automatic bounce angle correction (P.Fn-08, p.91).

? FAQ

- When the shooting distance to the subject changes**
 Press the <AI.B> button or the like (p.49) and re-measure the shooting distance to the subject.
- When a warning appears on the Speedlite LCD panel**

Warning	Solution
AI.B 	Attach the Speedlite to the camera, then press the <AI.B> button.
 RETRY 	An obstacle has come into contact with the flash head preventing the appropriate operation. Remove the obstacle and perform the same operation once again.
 AI.B ERROR	The same operation was performed three times, but the appropriate operation could not be completed. Turn the power off and on again, temporarily set the <AI.B> switch to the <0°> position, or do the like.
	The camera is not compatible with AI.B full-auto mode. Perform AI.B semi-auto shooting (p.56) or manual bounce flash photography (p.61).
CAMERA POWER IS OFF  OFF	The camera power is not turned on. Turn on the camera power, then press the <AI.B> button.
AI.B-F	Flash coverage angle cannot be manually set during AI.B full-auto shooting.
 WIDE PANEL	The wide panel cannot be used during AI.B full-auto shooting. Retract the wide panel.
BOUNCE ADAPTER	When the bounce adapter is used, the flash coverage cannot be set manually.
WIDE PANEL + BOUNCE ADAPTER	With the wide panel pulled out, the bounce adapter is attached. The flash coverage cannot be set manually.

- **The flash head does not move when the camera's depth-of-field preview button is pressed.**

To check whether or not the camera's depth-of-field preview button can be used to start distance measurement in AI.B full-auto mode (checking if the camera is compatible), see page 46.

- **The bounce angle is not automatically corrected even when the orientation (position) of the camera is changed.**

Double-clicking the camera's shutter button (pressing the shutter button halfway two times in a row within a short period) activates the flash head to move automatically, resetting the bounce angle to substantially the same angle as before you changed the orientation (position) of the camera.

- **Pictures are underexposed (insufficiently exposed).**

During bounce flash photography, less light reaches the subject and thus underexposure (insufficient exposure) is prone to occur. Take the action such as taking the picture as close to the subject as possible, increasing the camera's ISO speed, or opening the aperture of the lens before shooting.

Further, when the ceiling or wall for bouncing the flash light on is too far away, the ceiling is a dark color, or the ceiling is stepped or uneven, shooting with the appropriate exposure may not be possible since not enough light may reach the subject.

- **The color of the subject is not right.**

If the surface for bouncing the flash light is not white, a color cast may result in the picture or shooting with the appropriate exposure may not be possible since the bounced flash light may not reach the subject. Select a ceiling or wall that is close to a white color for bouncing the flash light off for high reflectance.



If the battery is not installed in the camera, the warning on the Speedlite may not be correctly displayed when the <AI.B> button is pressed.

AI.B AI.B Lamp

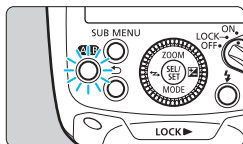

Depending on the state of the flash head during AI.B full-auto shooting, the display (lit/blinking) of the blue <AI.B> lamp changes.

Lamp	Status
Off	Before AI.B full-auto shooting is started
High-speed blinking	AI.B full-auto distance measurement in progress or bounce angle correction in progress
Lit	Distance measurement is complete (AI.B full-auto shooting possible)
Low-speed blinking	When bounce angle changed after distance measurement operation is complete
	Error in AI.B full-auto mode
	When the bounce angle changed after registration (with <ANGLE SET> set)
	When the flash head is not in the forward-facing position (before shooting in AI.B full-auto mode)

ANGLE SET : Bounce Angle Setting Button

When the <ANGLE SET> button is pressed during AI.B full-auto shooting, the bounce angle is stored (registered) in the Speedlite, and AI.B semi-auto shooting can be performed. For AI.B semi-auto shooting, see pages 56-59.



General Cautions for AI.B full-auto Shooting

- When the <AI.B> is switched to another mode or when the power switch is set to <OFF>, the bounce angle stored (registered) in the Speedlite is cleared.
- When using the FE lock or self-timer, double-click the shutter button, and once the flash head is reset (automatic correction) to the stored (registered) position, perform the FE lock operation or shooting.
- When a picture is taken with the camera oriented downward or upward, the appropriate bounce angle may not be automatically set. If this happens, take the picture using the following technique.
 - Perform AI.B semi-auto shooting (p.56)
 - Set the <AI.B> switch to the <0°> position so that the flash head is facing forward (p.42).
 - Manual bounce flash photography (p.61)
- When the <AI.B> button is pressed during movie shooting, although AI.B full-auto distance measurement operation (preflash) is performed, flash photography cannot be performed.
- When you turn the flash head, turn it slowly. While it may make a sound when you turn the flash head, it is not a malfunction. However, it may result in a mechanical failure if you continuously turn the flash head fast.



During AI.B full-auto shooting, you can fire the flash at the desired bounce angle as in manual bounce flash photography by pressing the <^{ANGLE}SET> button after determining the orientation (position) of the camera and adjusting the flash head.

AI.B-S AI.B Semi-Auto Shooting

For an overview of AI.B (AI bounce flash) semi-auto mode, see page 45. AI.B semi-auto shooting can be performed with all the EOS cameras. Before performing AI.B semi-auto shooting, review the “Safety Precautions” (p.8), “General Cautions for AI.B Full-Auto Shooting and AI.B Semi-Auto Shooting” (p.60), and the like.

Guidelines for Shooting Conditions in AI.B Semi-Auto Mode

See “Guidelines for Shooting Conditions in AI.B Full-Auto Mode” on page 48.

AI.B Semi-Auto Shooting

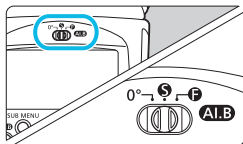

1 Set the <AI.B> switch to the <S> position (p.42).

- With the Speedlite attached to the camera, check that both the camera and the Speedlite are turned on.
- Set the <AI.B> bounce mode switch to the <S> position.
- ▶ When the flash head is not in the forward-facing position, the flash head moves and is automatically set to the forward-facing position.

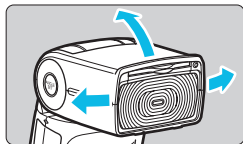

2 Set the bounce angle as desired.

- Determine the orientation (position) of the camera when taking a picture, and then perform steps 2 and 3.
- Taking into consideration factors such as the distance to the subject and the distance to the ceiling, manually move the flash head and set the bounce angle.
- ▶ The Speedlite icon on the LCD panel changes to <Speedlite icon>.

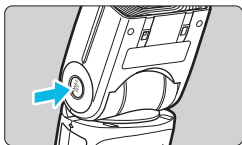

3 Press the < ANGLE SET > button.

- After you determine the bounce angle in step 2, press the < ANGLE SET > button to store (register) the bounce angle in the Speedlite.
- To re-register the bounce angle, perform steps 2 and 3 again.

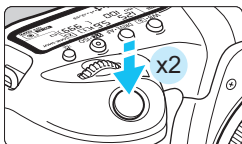

4 Take the picture.

- When the orientation (position) of the camera changes after the bounce angle is stored (registered) in the Speedlite in step 3, double-click the camera's shutter button (press the shutter button halfway two times in a row within a short period).
- ▶ The flash head automatically moves and resets to make the bounce angle substantially the same as when stored (registered).
- Focus on the subject and take the picture in the same way as with normal flash photography.
- Play back the image, then check the result.

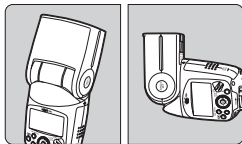

- 
 - When the shooting distance to the subject changes, adjust (reset) the bounce angle. When you want to re-register the adjusted bounce angle, press the $\langle \text{ANGLE}_{\text{SET}} \rangle$ button once again. Note that when the shutter button is pressed halfway without pressing the $\langle \text{ANGLE}_{\text{SET}} \rangle$ button once again, the bounce angle is set to the original value.
 - If the position of the flash head is moved (inadvertently) after the bounce angle is stored (registered) in the Speedlite (with the AI.B lamp blinking), when you press the shutter button halfway, the flash head automatically moves and is set in the position at the time of registration. (The bounce angle is automatically corrected.)
 - When a picture is taken during automatic correction of the bounce angle, the flash does not fire.
 - When using the FE lock or self-timer, double-click the shutter button, and once the flash head is reset (automatic correction) to the stored (registered) position, perform the FE lock operation or shooting.
 - When the $\langle \text{AI.B} \rangle$ is switched to another mode or when the power switch is set to $\langle \text{OFF} \rangle$, the bounce angle stored (registered) in the Speedlite is cleared.
 - When you turn the flash head, turn it slowly. While it may make a sound when you turn the flash head, it is not a malfunction. However, it may result in a mechanical failure if you continuously turn the flash head fast.
 - When the Speedlite's LCD panel displays a warning, see page 52.

- 
 - During AI.B semi-auto shooting, you can fire the flash at the desired bounce angle as in manual bounce flash photography by pressing the $\langle \text{ANGLE}_{\text{SET}} \rangle$ button after determining the orientation (position) of the camera and adjusting the flash head.
 - You can select the method to perform the automatic bounce angle correction (P.Fn-08, p.91).

AI.B AI.B Lamp

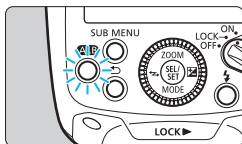

Depending on the state of the flash head during AI.B semi-auto shooting, the display (lit/blinking) of the blue <AI.B> lamp changes.

Lamp	Status
Off	Bounce angle not registered (before AI.B semi-auto shooting is started)
High-speed blinking	AI.B semi-auto operation in progress or bounce angle correction in progress
Lit	Bounce angle registration is complete (AI.B semi-auto shooting possible)
Low-speed blinking	When the bounce angle changes after registration
	Error in AI.B semi-auto mode
	When the flash head is not in the forward-facing position (before shooting in AI.B semi-auto mode)

? FAQ

When bounce angle automatic correction is not performed even when the orientation (position) of the camera is changed, underexposure (insufficient exposure) occurs, or the color of the subject is not right, see page 53.

General Cautions for AI.B Full-Auto Shooting and AI.B Semi-Auto Shooting

- If the camera is held at too steep an angle after a change of orientation (position), automatic bounce angle correction may not be performed. In addition, automatic bounce angle correction will not be performed when the change of orientation makes it impossible to reset to the stored bounce angle.
- Since the turning angle of the flash head is indicated in 5° increments, the angle may be displayed with a margin of error to an extent of 5° (before and after the automatic correction) such as when the bounce angle is automatically corrected.
- When the flash settings are cleared during AI.B full-auto shooting or AI.B semi-auto shooting (p.40), the bounce angle stored (registered) in the Speedlite is cleared. Therefore, pressing the shutter button halfway returns the flash head to the forward-facing position.
- AI bounce flash photography cannot be performed with the release button on a remote controller or the touch operation of the camera (not supported).

Notes for AI.B Full-Auto Shooting and AI.B Semi-Auto Shooting

When using an EOS DIGITAL camera released in and after the second half of 2017 (p.46), “AI_b” is displayed on the camera’s viewfinder as well as the LCD panel, and [AI BOUNCE] is displayed on the LCD monitor if the flash head moves in the following three cases, 1, 2, or 3.

1. When the <AI.B> button or the like is pressed for distance measurement operation during AI.B full-auto shooting (with the camera’s metering timer active).
2. When bounce angle correction is performed by double-clicking the shutter button during AI.B full-auto shooting or AI.B semi-auto shooting.
3. When the position of the flash head is (inadvertently) moved by pressing the shutter button halfway to automatically correct the bounce angle after distance measurement operation during AI.B full-auto shooting or after the bounce angle was stored (registered) in the Speedlite during AI.B semi-auto shooting.

Manual Bounce Flash Photography

When you want to perform manual bounce flash photography, perform the following settings and then adjust the orientation of the flash head.

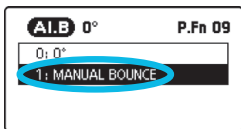

1 Set to P.Fn-09-1.

- See page 92, then set the Personal function P.Fn-09 (manual bounce setting) to 1.

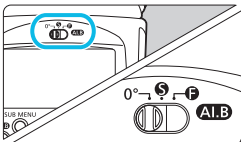

2 Set the <Al.B> switch to <0°>.

3 Set the bounce angle manually.

- Adjust the orientation of the flash head manually.
- You can check the bounce angle in the upward direction and horizontal direction using the LCD panel.
- ▶ The Speedlite icon on the LCD panel changes to .

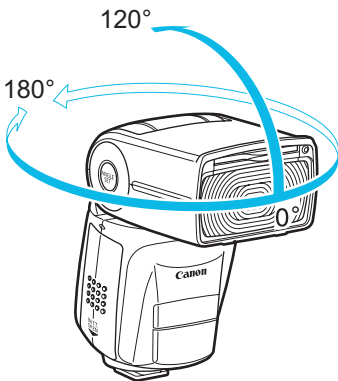

- When P.Fn-09 is set to 0 (p.92), you cannot manually set the bounce angle (the flash head automatically returns to the 0° position when the shutter button is pressed halfway even when you manually set the bounce angle).
- If the ceiling or wall for bouncing the flash light on is too far away, shooting with the appropriate exposure may not be possible since the bounced flash light may not reach the subject.
- If the picture appears dark, use a larger aperture opening (smaller f/ number) and try again. You can also increase the ISO speed when using a digital camera.
- Select a ceiling or wall that is close to a white color for bouncing the flash light off for high reflectance. If the bounce surface is not white, a color cast may result in the picture or shooting with the appropriate exposure may not be possible since the bounced flash light may not reach the subject.
- When Quick flash is fired with bounce flash, underexposure may occur since the flash output decreases.
- When you turn the flash head, turn it slowly. While it may make a sound when you turn the flash head, it is not a malfunction. However, it may result in a mechanical failure if you turn the flash head fast.

- When the flash head is turned while the flash coverage is set to  (automatic setting), the flash coverage is set at 50 mm and <--> is displayed.
- You can also manually set the flash coverage (p.34).

Combined Use with the Bounce Adapter

If you attach the provided bounce adapter to the Speedlite and bounce the flash light on the ceiling or wall, etc., you can spread the flash light across a larger area and suppress the shadows on the subject.

Also, if the bounce angle is set to 90° to bounce the flash light on the ceiling, etc., the diffused flash light emitted from the sides of the bounce adapter falls on the front of the subject (shooting distance guidance: within approx. 1.5 m/4.9 ft., at ISO 100 with f/2.8), further suppressing the shadow on the subject. When shooting portraits, the catchlight effect can also be obtained.

“Canon” logo

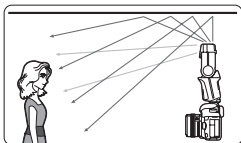
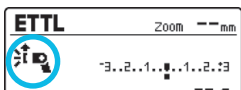
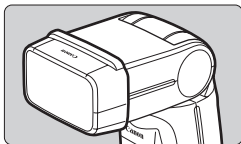
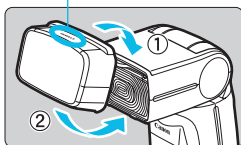



1 Attach the bounce adapter.

- Attach the adapter securely to the flash head until it clicks in place, as shown.
- Check that the display changes to .
- When removing the adapter, follow the procedure in reverse order. Raise the removal tab on the lower side of the adapter, then remove the adapter from the flash head.

2 Take the picture.

- During AI.B full-auto shooting (p.48), pressing the **<AI.B>** button automatically sets the bounce angle so that the flash head is facing toward the ceiling.
- Take the picture with the flash light bouncing off the ceiling, walls, or the like.

-  ● When the bounce adapter is attached, or when the bounce adapter and the wide panel are used together, underexposure may result since the flash output decreases. Take necessary countermeasures such as increasing the ISO speed on the camera or applying flash exposure compensation (p.30).
- Since the flash guide number decreases when the bounce adapter is attached, focusing with AF-assist beam using a series of small flashes may not be possible. Using infrared AF-assist beam is recommended (P.Fn-04-0, p.89).
- When Quick flash (p.21) is fired with the bounce adapter attached, taking the picture after the flash-ready lamp is lit in red is recommended since the flash output may not be sufficient.
- The flash coverage is set automatically when the bounce adapter is attached. You cannot change the setting.
- If you attach the bounce adapter to the flash when using an EOS DIGITAL camera released up to 2004, set the white balance to <AWB>. If you shoot with <⚡>, appropriate white balance may not be obtained.

-  ● The flash light is further softened when the wide panel (p.35) is used together with the bounce adapter.
- If the subject is dark (underexposed) when you check the shot image, perform flash exposure compensation (p.30). You can also increase the ISO speed when using a digital camera.
- During AI.B full-auto shooting and AI.B semi-auto shooting, you can press the < $\frac{\text{ANGLE}}{\text{SET}}$ > button to store (register) the bounce angle in the Speedlite even when the bounce adapter is mounted.

4

Setting Flash Functions with Camera Controls

This chapter describes how to set the flash functions from the camera's menu screen.

 When the camera's shooting mode is set to a fully automatic mode or a Basic Zone mode, the operations in this chapter are not available. Set the camera's shooting mode to <P/Tv/Av/M/bulb(B)> (Creative Zone mode).

Flash Control from the Camera's Menu Screen

When using EOS DIGITAL cameras released in and after 2007, you can set flash functions or Custom Functions from the camera's menu screen.

For camera operations, refer to the camera's Instruction Manual.

Flash Function Settings

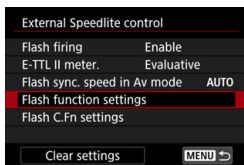
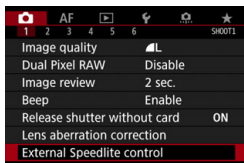

3 Set the function.

- The setting screen and items displayed vary depending on the camera.
- Select an item and set the function.

Example 1

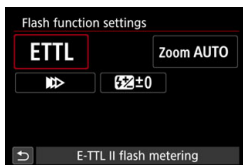

Example 2

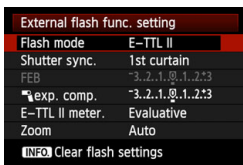

Settings Available on the Flash Function Settings Screen

- **EOS DIGITAL cameras released in and after 2007**

On the camera's [**Flash function settings**] or [**External flash func. setting**] screen, you can configure normal flash photography settings.

The settable functions are as follows. The settings available vary by the camera used, and flash mode, etc.

Functions	
Flash firing	Enable / Disable
E-TTL II flash metering	Evaluative / Average
Flash synchronization speed in Av mode	
Flash mode	E-TTL II (autoflash) / Manual flash
Shutter sync settings	1st curtain / 2nd curtain / High-speed
Flash exposure compensation	
Zoom (flash coverage)	
Clear settings	

- **Flash firing**

To perform flash photography, set to **[Enable]**. To use the flash's AF-assist beam only, set to **[Disable]**.

- **E-TTL II flash metering**

For normal exposures, set it to **[Evaluative]**. If **[Average]** is set, the flash exposure will be averaged for the entire scene metered by the camera. Flash exposure compensation may be necessary depending on the scene. This setting is for advanced users.

- **Flash synchronization speed in Av mode**

You can set the flash synchronization speed when shooting in **<Av>** aperture-priority AE mode with flash.

- **Flash mode**

You can select **[E-TTL II]** or **[Manual flash]** according to your photographic objectives.

- **Shutter sync settings**

You can select the flash firing timing/method from **[1st curtain]**, **[2nd curtain]**, or **[High-speed synchronization]**. To perform normal flash photography, set **[1st curtain]**.

- **Flash exposure compensation**

With a similar procedure as exposure compensation, you can adjust the flash output. The flash exposure compensation amount can be set up to ± 3 stops in 1/3-stop increments.

- **Zoom (flash coverage)**

You can set the Speedlite flash coverage. When [**Auto**] is selected, the flash coverage is set automatically according to the focal length of the shooting lens and the image sensor size of the camera (p.26).

- **Clear settings**

When [**Clear flash settings**] or [**Clear external flash set.**] is selected, you can revert the settings of Speedlite to their default settings.



If the flash coverage is automatically set such as when the bounce adapter is attached or the wide panel is used, or when the <ALB> switch is set to the <F> position, setting [**Zoom**] (flash coverage) is not possible.



- [**Flash firing**] and [**E-TTL II flash metering**] are displayed in step 2 or step 3 on page 66. (Display layouts and procedures vary by camera model.)
- When [**Flash sync. speed in Av mode**] is not displayed, it can be set with the camera's Custom Functions.
- When the flash exposure compensation is set on the flash, flash exposure compensation cannot be performed from the camera. If both are set at the same time, priority is given to the setting on the flash.

Flash Custom Function Settings

You can set Custom Functions for the Speedlite from the camera's menu screen. The details displayed vary by the camera. If C.Fn-21 to 23 are not displayed, set them by operating the Speedlite. For the Custom Functions, see pages 82-87.

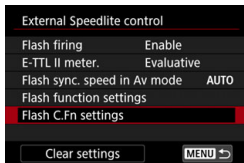

1 Select [Flash C.Fn settings].

- Select [**Flash C.Fn settings**] or [**External flash C.Fn setting**].
- ▶ The flash Custom Function settings screen is displayed.

Custom Function number

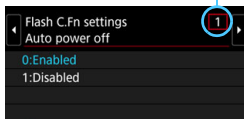

2 Set the Custom Function.

- Select the Custom Function number.
- Select an item and set the function.
- To clear all the Custom Function settings, select [**Clear settings**] in step 1, then [**Clear all Speedlite C.Fn's**] or [**Clear ext. flash C.Fn set.**].

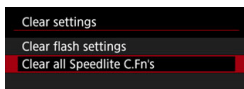

- ⚠ When using a camera released in 2011 or earlier, or with EOS REBEL T7/2000D/1500D, EOS REBEL T100/3000D/4000D, EOS REBEL T6/1300D and EOS REBEL T5/1200D, the C.Fn-21 to 23 settings are not cleared even if [**Clear all Speedlite C.Fn's**] or [**Clear ext. flash C.Fn set**] is selected. When the procedure to clear all the Custom Functions described on page 84 is performed, all the Custom Functions (except C.Fn-00) are cleared.
- Personal Functions (P.Fn, p.88) cannot be set or all cleared at once from the camera's menu screen. Set them by operating the Speedlite.

5

Wireless Flash Photography: Optical Transmission

This chapter describes wireless flash photography using the optical transmission wireless receiver function.

For the accessories required for optical transmission wireless shooting, see the system map (p.94).

 When the camera's shooting mode is set to a fully automatic mode or a Basic Zone mode, the operations in this chapter are not available. Set the camera's shooting mode to <P/Tv/Av/M/bulb(B)> (Creative Zone mode).

- 
- You can wirelessly control a 470EX-AI set as an optical transmission wireless receiver unit using a device equipped with the optical transmission wireless sender function (p.94).
 - The device equipped with the optical transmission wireless sender function is called the "sender", and a 470EX-AI that is controlled wirelessly is called a "receiver".

Optical Transmission Wireless Flash Photography

Using a Canon device equipped with an optical transmission wireless sender function and 470EX-AI set as a receiver unit, you can easily take pictures with wireless multiple flash lighting in the same way as normal E-TTL II/E-TTL autoflash photography.

The system is designed so that the settings of the sender unit are automatically applied to the wirelessly controlled 470EX-AI (receiver). Therefore, you do not need to operate the receiver unit during shooting (except when set as the individual receiver, p.79).

For details on how to perform optical transmission wireless flash photography, refer to the Instruction Manual of the device equipped with the sender function.

Positioning and Operation Range (Wireless flash photography examples)

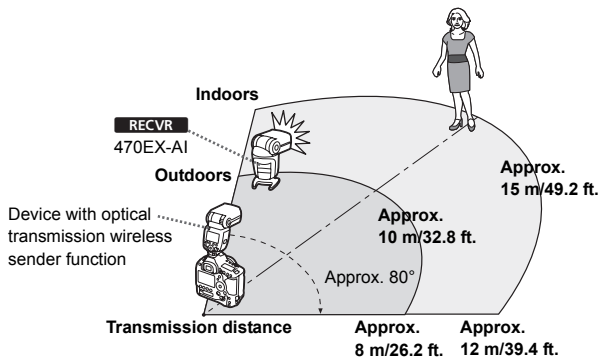

(Sender: With 600EX II-RT)



- To avoid interfering with transmission, do not place any obstacles between the sender unit and receiver unit.
- The transmission distance differs according to the sender unit used. Refer to the Instruction Manual of the device that is equipped with the sender function.
- Before shooting, perform a test flash (p.21) and test shooting.



- Place the wireless sensor of the receiver unit facing the sender unit.
- Position the receiver unit, using the provided mini stand (p.15).
- For details on the sender flash setting procedure, refer to the Instruction Manual of the device equipped with the optical transmission wireless sender function.

Wireless Settings

To perform flash photography using the optical transmission wireless receiver function, configure the settings as follows.

Receiver Unit Setting

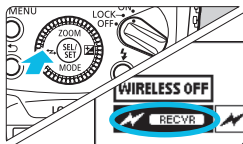

Set to <⚡> **RECVR** >.

- Operate and set the flash you want to set as the receiver unit.
- Press the <⚡> button of the <⬅➡> cross keys.
- Turn <⦿> to select <⚡> **RECVR** >, then press <⦿>.

ⓘ To perform normal flash photography, select <WIRELESS OFF> to clear the wireless (receiver) settings.

📷 When the flash is set as a receiver, the flash does not function even if the <ALB> switch is set to the <F> or <S> position.

Transmission Channel Setting

To avoid interference with optical transmission wireless flash systems used by other photographers, you can change the transmission channel. **Set the same channel for both the sender unit and receiver unit.**

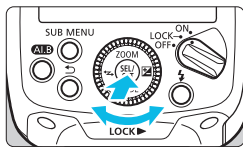

Set a transmission channel.

- Press <⦿>.
- Turn <⦿> to select the channel symbol, then press <⦿>.

Transmission channel

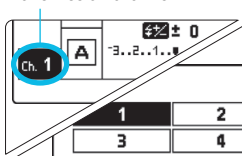

- Turn $\langle \odot \rangle$ to select a channel from Ch. “1” to “4”, then press $\langle \odot \rangle$.



If the transmission channels of the sender unit and receiver unit are different, the receiver unit will not fire. Set both to the same number.

Memory Function

You can save the wireless settings to the receiver unit and recall the settings later. Operate each receiver unit individually as you desire to save or recall its settings.

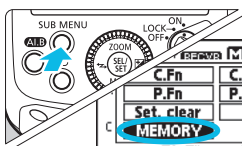

1 Select $\langle \text{MEMORY} \rangle$.

- Press the $\langle \text{SUB MENU} \rangle$ button.
- Turn $\langle \odot \rangle$ to select $\langle \text{MEMORY} \rangle$, then press $\langle \odot \rangle$.

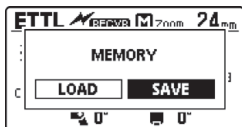

2 Save or load the settings.

- Turn $\langle \odot \rangle$ to select $\langle \text{SAVE} \rangle$ (save) or $\langle \text{LOAD} \rangle$ (load), then press $\langle \odot \rangle$.
- Select $\langle \text{OK} \rangle$.
- ▶ When you select $\langle \text{SAVE} \rangle$, the settings are saved (stored in memory).
- ▶ When you select $\langle \text{LOAD} \rangle$, the settings that were saved are set.

ETTL: Fully Automatic Wireless Flash Photography

This section describes basic fully automatic wireless shooting when using a device (sender) equipped with the optical transmission wireless sender function and a 470EX-AI set as a receiver unit.

For details on optical transmission wireless flash shooting and sender unit operation procedure, refer to the Instruction Manual of the sender device.

1 Set the sender unit.

- Set the device with the sender function as the optical transmission wireless sender unit.

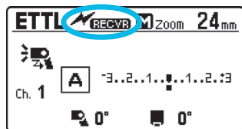

2 Set the receiver unit.

- Set the 470EX-AI to be controlled wirelessly from the sender unit as the receiver unit (p.74).
- A, B, or C can be set as the firing group.

3 Check the channel.

- If the channels of the sender unit and receiver unit are different, set them to the same number (p.74).

4 Position the camera and the flash.

- Position them within the range shown on page 72.

5 Set the flash mode to <ETTL>.

- Set the flash mode of the sender unit to <ETTL>.
- The receiver unit is set automatically to <ETTL> during shooting, controlled by the sender unit.
- Check that the firing group control is set to <ALL> (no flash ratio control is set: <RATIO OFF>).

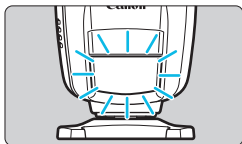

6 Check that the flash is ready.

- When the receiver unit is ready, the AF-assist beam emitter blinks at approx. 1-second intervals.
- Check that the sender unit's flash-ready lamp is lit.

7 Check the performance.

- Fire a test flash from the sender unit.
- ▶ The receiver unit fires. If it does not fire, check that it is placed within the transmission range (p.72).

8 Take the picture.

- Set the camera and take the picture in the same way as with normal flash photography.



If there is a fluorescent light or computer monitor near a receiver unit, the presence of the light source may cause the receiver unit to malfunction and fire inadvertently.



- The receiver unit's flash coverage is set to 24 mm. You can also set the flash coverage manually.
- If the receiver unit's auto power off takes effect, press the sender unit's test flash button to turn on the receiver unit. Note that the test flash cannot be performed while the camera's metering timer, etc. is operating.
- You can change the time until the receiver unit's auto power off takes effect (C.Fn-10, p.86).
- You can disable the blinking of the AF-assist beam emitter when recharge is complete for the receiver unit (C.Fn-23, p.87).

Advanced Shooting with Fully Automatic Wireless Flash

Since the following functions set on the sender unit will be set automatically to the receiver units on this wireless system, you do not need to operate the receiver unit(s). For this reason, you can perform wireless flash photography in the same way as normal flash photography.

- **Flash exposure compensation** (Fn, p.30)
- **High-speed sync** (Fn, p.32)
- **FE lock** (p.31)
- **Manual flash** (p.36)

- You can also directly operate the receiver unit to individually set flash exposure compensation and flash coverage on each receiver unit (p.79).
- You can also perform FEB shooting and stroboscopic flash using the 470EX-AI set as a receiver unit with a sender unit equipped with FEB and stroboscopic flash functions.

Setting the Firing Group

Set the firing group when performing two-group (A, B) or three-group (A, B, C) wireless shooting using 470EX-AI set as the receiver units.

Firing group

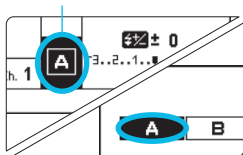

Set the firing group of the receiver units.

- Operate and set the receiver units one by one.
- Press <Fn>.
- Turn <Fn> to select the firing group, then press <Fn>.
- Turn <Fn> to select <A>, , or <C>, then press <Fn>.

You can directly operate the receiver unit to manually set the manual flash. This function is called individual receiver. This is useful when, for example, you use the Speedlite Transmitter ST-E2 (sold separately) to perform wireless manual flash.

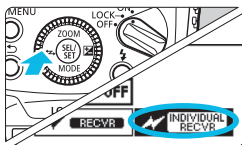

1 Set the individual receiver.

- Press the <↔> button of the <⬆️> cross keys.
- Turn <⊙> to select <⚡ INDIVIDUAL RECVR >, then press <⊙>.
- ▶ < INDIVIDUAL RECVR > appears on the LCD panel.
- ▶ The flash mode is set to <M>.

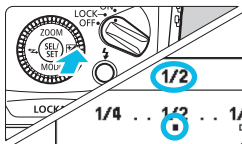
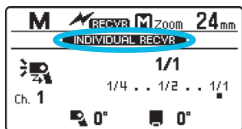

2 Set the flash output.

- Press the <⊞> button of the <⬆️> cross keys.
- Turn <⊙> to set the flash output, then press <⊙>.



A receiver unit that is set as an individual receiver cannot receive flash mode control from the sender unit. The receiver unit always fires at the set flash output.



6

Customizing the Speedlite

This chapter describes how to customize the Speedlite with the Custom Functions (C.Fn) and Personal Functions (P.Fn).

 When the camera's shooting mode is set to a fully automatic mode or a Basic Zone mode, the operations in this chapter are not available. Set the camera's shooting mode to <P/Tv/Av/M/bulb(B)> (Creative Zone mode).

C.Fn / P.Fn: Setting Custom and Personal Functions

You can make precise adjustments to various flash functions to suit your picture-taking preferences. The functions used to do this are called the Custom Functions and Personal Functions. The Personal Functions are customizable functions unique to the 470EX-AI.

C.Fn: Custom Functions

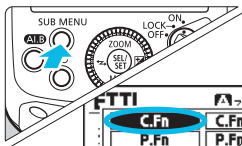

1 Display the Custom Functions screen.

- Press the <SUB MENU> button.
- Turn <ZOOM SEL> to select <C.Fn>, then press <ZOOM SEL>.
- ▶ The Custom Functions screen is displayed.

2 Select an item to set.

- Turn <ZOOM SEL> to select an item (number) to be set.

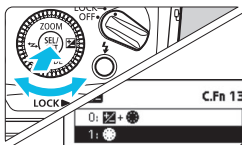

3 Change the setting.

- Press <ZOOM SEL>.
- ▶ The setting is displayed.
- Turn <ZOOM SEL> to select your desired setting, then press <ZOOM SEL>.

P.Fn: Personal Functions

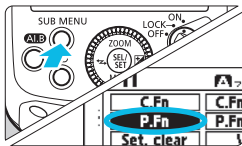











1 Display the Personal Functions screen.

- Select <P.Fn> in the same way as step 1 for the Custom Functions, then press <ZOOM SEL>.
- ▶ The Personal Functions screen is displayed.









2 Set the function.

- Set the Personal Functions in the same way as steps 2 and 3 for the Custom Functions.

Custom Function List

Number	Function		Page
C.Fn-00		Distance indicator display	p.85
C.Fn-01		Auto power off	
C.Fn-02	 MODELING	Modeling flash	
C.Fn-08	 AF	AF-assist beam firing	p.86
C.Fn-10		Receiver auto power off timer	
C.Fn-11		Receiver auto power off cancel	
C.Fn-13		Flash exposure compensation setting	p.87
C.Fn-21		Light distribution	
C.Fn-22		LCD panel illumination	
C.Fn-23		Receiver flash charge check	

Personal Function List

Number	Function		Page
P.Fn-01		LCD panel display contrast	p.88
P.Fn-02		LCD panel illumination color: Normal flash photography	
P.Fn-03		LCD panel illumination color: Receiver	
P.Fn-04		AF-assist beam emission method	p.89
P.Fn-05		Quick flash	
P.Fn-06		Dial setting changes	p.90
P.Fn-07		Maximum bounce angle	
P.Fn-08		Automatic bounce angle correction	p.91
P.Fn-09		Manual bounce setting	p.92

Clearing All the Custom/Personal Functions

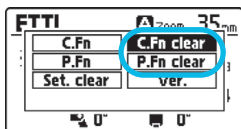

You can clear all Custom Functions or Personal Functions by selecting < **C.Fn clear** > or < **P.Fn clear** > on the screen on the left, then selecting < **OK** >.

Even if you clear all Custom Functions, C.Fn-00 will not be cleared.

You can set or clear all Custom Functions of the Speedlite on the camera's menu screen (p.70).

C.Fn: Setting Custom Functions

C.Fn-00: m/ft (Distance indicator display)

You can select meters or feet for the distance indicator display on the LCD panel.

0: m (Meters (m))

1: ft (Feet (ft))

C.Fn-01: (Auto power off)

When the Speedlite is not operated for approx. 90 seconds, the power turns off automatically to save energy. You can disable this function.

0: ON (Enabled)

1: OFF (Disabled)



C.Fn-02: MODELING (Modeling flash)

0:  (Enabled (Depth-of-field preview button))

Press the camera's depth-of-field preview button to fire the modeling flash.

1:  (Enabled (Test firing button))

Press the Speedlite's test flash button to fire the modeling flash.

2: / (Enabled (with both buttons))

Press the camera's depth-of-field preview button or the Speedlite's test flash button to fire the modeling flash.

3: OFF (Disabled)

Disables the modeling flash.



- When the <A.I.B> switch is set to the <F> position, the modeling flash may not fire when the camera's depth-of-field preview button is pressed. When you want to fire the modeling flash during A.I.B full-auto shooting, setting C.Fn-02 to 1 or 2 and firing the modeling flash using the Speedlite's test flash button is recommended.
- With the depth-of-field preview function assigned to a button on the camera using the camera's customization features, you can fire the modeling flash using the assigned button when C.Fn-02 is set to 0 or 2 (except for EOS M series camras).

C.Fn-08: AF (AF-assist beam firing)

0: **ON (Enabled)**

1: **OFF (Disabled)**

This disables the emission of the AF-assist beam from the Speedlite.

 The flash icon displayed when C.Fn-08 is set changes according to the P.Fn-04 (AF-assist beam emission method, p.89) setting.

C.Fn-10: (Receiver auto power off timer)

When set as an optical transmission wireless receiver unit, the time until auto power off takes effect can be changed. Note that when the receiver unit's auto power off takes effect,  is displayed on the LCD panel. Set this function on each receiver unit.

0: **60min (60 minutes)**

1: **10min (10 minutes)**

C.Fn-11: (Receiver auto power off cancel)

In optical transmission wireless flash photography, when you press the test flash button on the sender unit, you can turn on the receiver units that are in the auto power off state. You can change the time for the receiver units in the auto power off state to accept this function. Set this function on each receiver unit.



0: **8h (Within 8 hours)**

1: **1h (Within 1 hour)**

C.Fn-13: (Flash exposure compensation setting)

0:  (Speedlite button and dial)

1:  (Speedlite dial only)

You can directly set the flash exposure compensation amount and flash output by turning  without pressing the  button of the  cross keys.

C.Fn-21:  (Light distribution)

You can change the flash light distribution (flash coverage) of the Speedlite in relation to the shooting angle of view when the flash coverage is set to  (automatic setting).

0:  (Standard)

The optimum flash coverage for the shooting angle of view is set automatically.

1:  (Guide number priority)

Although the periphery of the picture is slightly darker than the 0 setting, this is effective when you want to give priority to the flash output. The flash coverage is set automatically to a slightly more telephoto position than the actual shooting angle of view. The display changes to .

2:  (Even coverage)



Although the possible flash photography distance becomes slightly shorter than the 0 setting, this is effective when you want to minimize light falloff at the periphery of the picture. The flash coverage is set automatically to a slightly wider position than the actual shooting angle of view. The display changes to .

C.Fn-22:  (LCD panel illumination)

When a button or dial is operated, the LCD panel illuminates. You can change this illumination setting.

0: 12sec (On for 12 sec.)**1: OFF (Disable panel illumination)****2: ON (Illumination always on)****C.Fn-23:  (Receiver flash charge check)**

When recharge is complete for the receiver unit during optical transmission wireless shooting, its AF-assist beam emitter blinks. You can disable this blinking. Set this function on each receiver unit.

0:  (AF-assist beam, )**1:  ()**

P.Fn: Setting Personal Functions

P.Fn-01: (LCD panel display contrast)

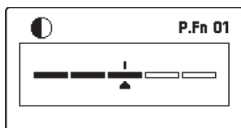

You can adjust the contrast of the LCD panel in 5 levels.

P.Fn-02: (LCD panel illumination color: Normal flash photography)

You can set the color of the LCD panel illumination for normal flash photography (on-camera flash photography).

- 0: **GREEN** (Green)
- 1: **ORANGE** (Orange)

P.Fn-03: (LCD panel illumination color: Receiver)

You can select the color of the LCD panel illumination for the Speedlite set as the receiver unit in optical transmission wireless flash photography.

- 0: **ORANGE** (Orange)
- 1: **GREEN** (Green)

P.Fn-04:  /  AF (AF-assist beam emission method)

You can select the AF-assist beam emission method.

0:  (Infrared)

An infrared AF-assist beam is emitted (p.27). Focusing on the subject with the subject positioned at the viewfinder center is recommended.

1:  (A series of small flashes)

AF-assist beam, which uses intermittent flashes (a series of small flashes), is emitted.



The AF-assist beam, which uses a series of small flashes, is emitted when 470EX-AI is attached to an EOS DIGITAL camera equipped with a function for controlling external flashes from the camera's menu screen. Note that, depending on the camera model, the camera's firmware may need to be updated.



P.Fn-05:  QUICK (Quick flash)

You can set whether or not to fire the flash (fire the Quick flash) when the flash-ready lamp is lit in green (before the flash is fully charged) to shorten the charge waiting time. Quick flash also takes effect during continuous shooting.

0: ON (Enabled)**1: OFF (Disabled)**

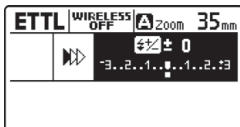
When Quick flash is fired during continuous shooting, underexposure may occur since the flash output decreases.



P.Fn-06:  DIRECT (Dial setting changes)

When  is pressed and the screen displays the settings as shown on the left, you can set whether or not the following functions can be directly set by simply turning .

0: OFF (Disabled)

Set the function using the normal operation procedure.

1: ON (Enabled)

You can directly set the function by selecting “Flash exposure compensation amount” and “Manual flash output” using the  cross keys, then simply by turning .

P.Fn-07:  /  /  (Maximum bounce angle)

You can set the maximum bounce angle in the upward direction during AI.B full-auto shooting. When you want to limit the maximum bounce angle so that the flash head does not turn toward the photographer, set to 2.

0: 120°

1: 140°





2: 90°

-  ● With “1” set, be careful of the direction of the flash head since the flash head may fire toward the photographer.
- P.Fn-07 takes effect only during AI.B full-auto shooting. Note that the settings set by P.Fn-07 do not function when $\langle \overset{\text{ANGLE}}{\text{SET}} \rangle$ is pressed and the bounce angle is stored (registered) in Speedlite during AI.B semi-auto shooting or AI.B full-auto shooting.
- If P.Fn-07 setting is changed, perform the distance measurement operation (p.49) again.

 When a bounce angle that exceeds 120° is automatically set with this setting set to 1, the angle may be set after the flash head rotates 180°.

P.Fn-08: ↔ (Automatic bounce angle correction)

You can set how the bounce angle is to be automatically corrected when the orientation (position) of the camera changes during < **AI.B-F** > AI.B full-auto shooting or < **AI.B-S** > AI.B semi-auto shooting.

- 0:**   x2
When the shutter button is double-clicked (pressed halfway two times in a row within a short period), bounce angle correction is performed.
- 1: AUTO**
When the camera's metering timer is active, bounce angle correction is automatically performed (without pressing the shutter button halfway).
- 2:**   x1
When the shutter button is pressed halfway, bounce angle correction is performed.

 When set to 1 or 2, bounce angle correction may take effect, not only when the shutter button is pressed but also when any other button on the camera is pressed.

P.Fn-09: **AI.B** 0° (Manual bounce setting)

When the < **AI.B** > bounce mode switch is set to < **0°** >, you can set whether or not the bounce angle can be set manually.

0: 0°

Manual bounce shooting (setting the bounce angle manually) cannot be performed. After the bounce angle has been manually set, pressing the shutter button halfway returns the flash head to the forward-facing position.

1: MANUAL BOUNCE

Set to this when performing manual bounce flash photography (manually setting the bounce angle).

 In AI.B full-auto shooting mode or AI.B semi-auto shooting mode, bounce angle correction is performed when the orientation (position) of the camera changes, even when set to 1.

7

Reference

This chapter provides a system map and troubleshooting guide, and describes the use of the Speedlite with Type-B cameras.

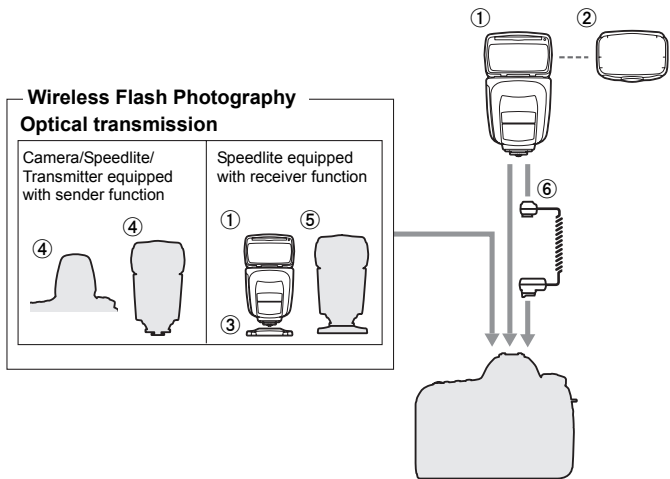

- ① **Speedlite 470EX-AI**
- ② **Bounce adapter SBA-E4** (provided with 470EX-AI)
- ③ **Mini stand** (provided with 470EX-AI)
- ④ **Device equipped with optical transmission wireless sender function**
600EX II-RT, 600EX-RT, 600EX, 580EX II, 580EX, 550EX, 90EX, MT-26EX-RT, MT-24EX, MR-14EX II, MR-14EX, ST-E2, and EOS DIGITAL cameras with optical transmission wireless sender function by built-in flash

⑤ **Speedlite equipped with optical transmission wireless receiver function**

600EX II-RT, 600EX-RT, 600EX, 580EX II, 580EX, 550EX, 430EX III-RT, 430EX III, 430EX II, 430EX, 420EX, 320EX, 270EX II

⑥ **Off-Camera Shoe Cord OC-E3**

Enables the 470EX-AI to be connected to the camera up to approx. 60 cm / 2 ft. away.

- When using a Speedlite without a function for switching the firing groups (A, B, C) in ⑤, you can use the Speedlite as a receiver in firing group A during optical transmission wireless shooting (you cannot use it as a receiver in firing group B or C).
- During AI.B full-auto shooting, do not use the Off-Camera Shoe Cord OC-E3 (an appropriate bounce angle is not automatically set).
- Do not use 470EX-AI, attaching it to the Speedlite Bracket SB-E2 (sold separately) or the like. 470EX-AI does not fit securely to the bracket and will be somewhat unstable, possibly causing the flash head to come into contact with the bracket section during AI bounce flash.

Flash Firing Restrictions due to Temperature Increase



When continuous flash or modeling flash is repeatedly fired in short intervals, the temperature of the flash head, batteries, and the area near the battery compartment may increase.

When you perform firing repeatedly, the firing interval increases in steps to avoid degrading or damaging the flash head due to overheating. When you perform firing repeatedly even more in this state, flash firing is restricted automatically.

Furthermore, when flash firing is restricted, a warning icon is displayed to indicate the increase in temperature, and the firing interval (with which the flash photography can be performed) will be automatically set to approx. 8 sec. (level 1) or approx. 20 sec. (level 2).

Temperature Increase Warning

As the internal temperature of the Speedlite increases, the warning is displayed in two levels. When you perform continuous firing repeatedly even more in the state in level 1, the state changes to level 2.

Display	Level 1 (Firing interval: Approx. 8 sec.)	Level 2 (Firing interval: Approx. 20 sec.)
Icon		
LCD panel illumination	Red (lit)	Red (blinking)

Number of Continuous Flashes and Rest Time

The following table shows the number of continuous flashes until the warning (level 1) is displayed, and the necessary rest time (guideline) until normal flash photography can be performed.

Function	Number of Continuous Flashes to Reach Level 1 Warning (Guideline)				Necessary Interval Time (Guideline)
	Flash Coverage				
	14mm	24mm	28mm	35mm or more	
Continuous full output flash (p.17)	45 times or more				40 min. or longer
Modeling flash (p.38)	35 times or more		40 times or more		

 **CAUTION**

When performing continuous flash, do not touch the flash head, batteries, or the area near the battery compartment.

When continuous flash or modeling flash is repeatedly fired at short intervals, do not touch the flash head, batteries, or the area near the battery compartment. The flash head, batteries, and area near the battery compartment may become hot, resulting in the risk of burn.



- Do not open or close the battery compartment cover while flash firing is being restricted. Doing so is very dangerous since the flash firing restriction is canceled.
- Even when level 1 warning is not displayed, the firing interval will be extended as the flash head begins to heat up.
- If level 2 warning is displayed, allow a rest time for at least 40 min.
- Even if you stop flash firing after level 1 warning is displayed, level 2 warning may be displayed.
- If flash photography is performed in high temperatures, the firing restrictions may be activated before the number of flashes listed in the table on the preceding page is fired.
- For cautions on the number of flash firings, see page 17 (continuous flashes) or page 39 (modeling flash).
- The Speedlite may not fire in rare cases due to environmental factors such as temperature rise.
- When the bounce adapter is used, the number of continuous flashes until the warning is displayed becomes slightly fewer.
- When C.Fn-22-1 is set (p.87), the warning with red illumination of the LCD panel will not be displayed even if the temperature of the flash head rises.

Troubleshooting Guide

If a problem occurs with the flash, first refer to this Troubleshooting Guide. If this Troubleshooting Guide does not resolve the problem, contact your dealer or nearest Canon Service Center.

● Normal Flash Photography

The power does not turn on.

- Make sure the batteries are installed in the correct orientation (p.18).
- Make sure the battery compartment cover is closed (p.18).
- Replace the batteries with new ones.

The Speedlite does not fire.

- Insert the mounting foot into the camera's hot shoe all the way, slide the lock lever to the right, and secure the Speedlite to the camera (p.20).
- If the < **CHARGE** > indication remains displayed for approx. 30 sec. or longer, replace the batteries (p.18).
- If the electrical contacts of the Speedlite or camera are dirty, wipe the contacts (p.10) with a dry cloth, etc.
- When you perform continuous firing repeatedly over a short period of time, causing the temperature of the flash head to rise and flash firing to be restricted, the firing interval increases (p.96).

The power turns off by itself.

- The Speedlite's auto power off has been activated (p.22). Press the camera's shutter button halfway or press the Speedlite's test flash button (p.21).

Pictures are underexposed or overexposed.

- If the main subject looks very dark or very bright, set flash exposure compensation (p.30).
- If there is a highly reflective object in the picture, use FE lock (p.31).
- With high-speed sync, the faster the shutter speed, the lower the guide number becomes. Move closer to the subject (p.32).

The bottom of the picture looks dark.

- Move at least 0.7 m/2.3 ft. away from the subject.
- Remove the lens hood if attached.

The picture periphery looks dark.

- Set the flash coverage to **<A>** (automatic setting, p.34).
- When manually setting the flash coverage, set a flash coverage wider than the shooting angle of view (p.34).
- Make sure C.Fn-21-1 is not set (p.87).

The picture is very blurred.

- When the shooting mode is set to the **<Av>** aperture-priority AE mode and the scene is dark, slow sync is enabled automatically (the shutter speed becomes slower). Use a tripod, or set the shooting mode to the **<P>** program AE or fully automatic mode (p.25). Note that you can also set the sync speed in **[Flash sync. speed in Av mode]** (p.68).

The flash coverage is not set automatically.

- Set the flash coverage to <A> (automatic setting, p.34).
- Insert the mounting foot into the camera's hot shoe all the way, slide the lock lever to the right, and secure the Speedlite to the camera (p.20).

The flash coverage cannot be set manually.

- Remove the bounce adapter (p.63).
- Retract the wide panel (p.35).
- Flash coverage angle cannot be manually set during AI.B full-auto shooting (p.52).

Functions cannot be set.

- Set the camera's shooting mode to <P/Tv/Av/M/bulb(B)> (Creative Zone mode).
- Set the Speedlite's power switch to <ON> instead of <LOCK> (p.21).

The Speedlite fires continuously.

- When the Speedlite continuously fires after focusing with AF, check if the Speedlite is set to P.Fn-04-1 (p.89).

● Bounce Flash Photography

The flash head moves on its own.

- When Speedlite is first started and the shutter button on the camera is pressed halfway with the flash head in a position other than the forward-facing (0°) position, the flash head automatically moves to the forward-facing (0°) position.
- The AI bounce flash function is activated. When you do not want to use the AI bounce flash function, set the <AI.B> switch to the <0°> position (p.42).
- When the position of the flash head changes after you press the <ANGLE SET> button and store (register) the bounce angle in the Speedlite, pressing the camera's shutter button halfway returns the flash head to the registered position.

“AI.B⊙” is displayed. / The flash head does not move.

- When Speedlite is not attached to the camera, the “AI.B⊙” animation is displayed and the flash head's AI bounce flash operation is not performed.
- When the orientation (position) of the camera has changed, double-clicking the shutter button (pressing the shutter button halfway two times in a row within a short period) activates the bounce angle correction.

In AI.B full-auto mode, the flash head does not move even when I press the camera's depth-of-field preview button.

- Check whether or not the camera's depth-of-field preview button functions as an AI.B full-auto distance measurement start button (p.46).

The modeling flash fires when the camera's depth-of-field preview button is pressed.

- Check whether or not the camera's depth-of-field preview button functions as an AI.B full-auto distance measurement start button (p.38, 46, 85).

A warning is displayed.

- For warning displays, see page 52.

The flash coverage cannot be set manually.

- The flash coverage cannot be manually set in AI.B full-auto shooting, with the bounce adapter attached, or with wide panel used.

The bounce angle cannot be set manually.

- When you want to perform manual bounce flash photography, see page 61.

Pictures are underexposed.

- During bounce flash photography, less light reaches the subject and thus underexposure (insufficient exposure) is prone to occur. Take the action such as taking the picture as close to the subject as possible, increasing the camera's ISO speed, or opening the aperture of the lens before shooting.
- When the ceiling or wall for bouncing the flash light on is too far away, the ceiling is dark, or the ceiling is stepped or uneven, shooting with the appropriate exposure may not be possible since not enough light may reach the subject.

The color of the subject is not right.

- If the surface for bouncing the flash light is not white, a color cast may result in the picture or shooting with the appropriate exposure may not be possible since the bounced flash light may not reach the subject. Select a ceiling or wall that is close to a white color for bouncing the flash light off for high reflectance.

Modeling flash does not work.

- Depending on the camera used, the camera's depth-of-field preview button may function as the < **AL.B** > full-auto distance measurement start button. For details, see pages 46 and 85.

● Optical Transmission Wireless Flash Photography

The receiver unit does not fire.

- Set the receiver unit to < ⚡ **RECVR** > (p.74).
- Set the transmission channels of the sender unit and receiver unit to the same numbers (p.74).
- Make sure the receiver unit is within the transmission range of the sender unit (p.72).
- Point the wireless sensor of the receiver unit toward the sender unit (p.72).
- Position the receiver unit at a location with the clearest possible view of the sender unit.
- If the sender unit and receiver unit are too close, the transmission may not take effect properly.
- When using the camera's built-in flash as the sender unit, raise the camera's built-in flash, and set **[Wireless func.]** on the camera's **[Built-in flash func. setting]** screen.

Specifications

● Type

Type:	E-TTL II/E-TTL autoflash Shoe-mount Speedlite
Compatible cameras:	Type-A EOS cameras (E-TTL II/E-TTL autoflash) * Autoflash is not possible when using Type-B EOS cameras.

● Flash Head (Light-emitting unit)

Guide No.:	Approx. 47/154.2 (at 105 mm flash coverage, ISO 100, in meters/feet) * Without bounce adapter
Flash coverage:	Supports a shooting angle of view with a lens focal length of 24-105 mm (with wide panel use: 14 mm) • Automatic setting (Automatically sets the flash coverage depending on the shooting angle of view and the image sensor size.) • Manual setting
Bounce mode:	AI.B full-auto (AI.B-F), AI.B semi-auto (AI.B-S), manual
Bounce angle:	120° up, 180° left, 180° right
Bounce adapter:	Provided
Flash duration (During normal flash):	1/1 flash: Approx. 1/950 sec. 1/2 flash: Approx. 1/1210 sec. 1/4 flash: Approx. 1/1700 sec. 1/8 flash: Approx. 1/2100 sec. 1/16 flash: Approx. 1/2240 sec. 1/32 flash: Approx. 1/2400 sec. 1/64 flash: Approx. 1/2690 sec. 1/128 flash: Approx. 1/2700 sec.
Color temperature information transmission:	Flash light color temperature information transmitted to camera when flash is fired

● Exposure Control

Exposure control system:	E-TTL II/E-TTL autoflash, Manual flash
Effective flash metering range: (with EF50mm f/1.4 lens at ISO 100)	Normal flash: Approx. 0.7 - 23.5 m / 2.3 - 77.1 ft. Quick flash: Approx. 0.7 - 14.4 m / 2.3 - 47.2 ft. (at Guide No. 20.2 / 66.3, in meters/feet) High-speed sync: Approx. 0.7 - 12.5 m / 2.3 - 41.0 ft. (at 1/250 sec.)
Flash exposure compensation:	±3 stops in 1/3- or 1/2-stop increments
FE lock:	Possible with the camera's Multi-function button or FE lock/AE lock button
High-speed sync:	Possible
Manual flash:	1/1 - 1/128 power (1/3-step increments)
Modeling flash:	Fired with camera's depth-of-field preview button or Speedlite's test flash button

● Flash Recharge

Firing interval (Recharge time):	Normal flash: Approx. 0.1 - 5.5 sec., Quick flash: Approx. 0.1 - 3.9 sec. * When using AA/LR6 alkaline batteries
Flash-ready lamp:	Lights up in red: Normal flash available Lights up in green: Quick flash available

● AF-Assist Beam

Method:	Switchable in Personal Functions between Infrared assist beam and Intermittent flashes (a series of small flashes)
Compatible AF system:	TTL second image formation phase-difference AF 1 - 19 AF points (Infrared assist beam / 28 mm or longer lens focal length) Supported for viewfinder shooting, and Quick mode for Live View shooting or movie shooting
Effective distance:	At center: Approx. 0.7 - 10 m / 2.3 - 32.8 ft., At periphery: Approx. 1 - 5 m / 3.3 - 16.4 ft.

● Optical Transmission Wireless Receiver Function

Communication method:	Optical pulse
Wireless settings:	Receiver
Transmission channel:	Ch. 1 - 4
Receiver unit setting:	Firing groups A, B, C
Reception angle:	Approx. $\pm 45^\circ$ horizontally, approx. $\pm 25^\circ$ upward, and approx. $\pm 20^\circ$ downward, facing the sender unit
Charge confirmation:	Flash-ready lamp lights up and the AF-assist beam emitter blinks when fully charged

● Customization Features

Custom Functions:	10 types
Personal Functions:	9 types

● Power Source

Speedlite power source:	Four AA/LR6 alkaline batteries * AA/HR6 Ni-MH batteries can be used
Number of flashes:	Approx. 115 - 800 times * When using AA/LR6 alkaline batteries
Auto power off:	Power off after approx. 90 sec. of idle operation * When set as receiver unit: approx. 60 min.

● Dimensions and Weight

Dimensions (W x H x D):	Approx. 74.6 x 130.4 x 105.1 mm / 2.94 x 5.13 x 4.14 in.
Weight:	Approx. 385 g / 13.6 oz. (Speedlite only, excluding batteries)

● Operation Environment

Working temperature range:	0°C - 45°C / 32°F - 113°F
Working humidity:	85% or less

- All specifications above are based on Canon's testing standards.
- Product specifications and the exterior are subject to change without notice.

Guide Number (ISO 100, in approx. meters/feet)

● Normal Flash (Full Output)/Quick Flash

Flash Coverage (mm)	14	24	28	35
Normal Flash (Full Output)	14.0 / 45.9	25.0 / 82.0	26.0 / 85.3	29.0 / 95.1
Quick Flash	Equivalent to approx. 1/2 - 1/6 of full output			

Flash Coverage (mm)	50	70	80	105
Normal Flash (Full Output)	33.0 / 108.3	40.0 / 131.2	42.0 / 137.8	47.0 / 154.2
Quick Flash	Equivalent to approx. 1/2 - 1/6 of full output			

● Manual Flash

Flash Output	Flash Coverage (mm)			
	14	24	28	35
1/1	14.0 / 45.9	25.0 / 82.0	26.0 / 85.3	29.0 / 95.1
1/2	9.9 / 32.5	17.7 / 58.1	18.4 / 60.4	20.5 / 67.3
1/4	7.0 / 23.0	12.5 / 41.0	13.0 / 42.7	14.5 / 47.6
1/8	4.9 / 16.1	8.8 / 28.9	9.2 / 30.2	10.3 / 33.8
1/16	3.5 / 11.5	6.3 / 20.7	6.5 / 21.3	7.3 / 24.0
1/32	2.5 / 8.2	4.4 / 14.4	4.6 / 15.1	5.1 / 16.7
1/64	1.8 / 5.9	3.1 / 10.2	3.3 / 10.8	3.6 / 11.8
1/128	1.2 / 3.9	2.2 / 7.2	2.3 / 7.5	2.6 / 8.5

Flash Output	Flash Coverage (mm)			
	50	70	80	105
1/1	33.0 / 108.3	40.0 / 131.2	42.0 / 137.8	47.0 / 154.2
1/2	23.3 / 76.4	28.3 / 92.8	29.7 / 97.4	33.2 / 108.9
1/4	16.5 / 54.1	20.0 / 65.6	21.0 / 68.9	23.5 / 77.1
1/8	11.7 / 38.4	14.1 / 46.3	14.8 / 48.6	16.6 / 54.5
1/16	8.3 / 27.2	10.0 / 32.8	10.5 / 34.4	11.8 / 38.7
1/32	5.8 / 19.0	7.1 / 23.3	7.4 / 24.3	8.3 / 27.2
1/64	4.1 / 13.5	5.0 / 16.4	5.3 / 17.4	5.9 / 19.4
1/128	2.9 / 9.5	3.5 / 11.5	3.7 / 12.1	4.2 / 13.8

Using with a Type-B Camera

This section describes the available and unavailable functions when using the Speedlite 470EX-AI with a Type-B camera (EOS film camera supporting A-TTL/TTL autoflash).

When the Speedlite is attached to a Type-B camera, <ETTL> is displayed on the LCD panel of the flash. Autoflash metering cannot be performed.

● Functions available with Type-B cameras

- Manual flash
- Second-curtain sync
- AI.B semi-auto

● Functions not available with Type-B cameras

- E-TTL II/E-TTL/TTL autoflash
- Flash exposure compensation
- FE lock
- High-speed sync
- Quick flash
- Modeling flash
- AI.B full-auto

This device complies with Part 15 of the FCC Rules. Operation is subject to the following two conditions: (1) This device may not cause harmful interference, and (2) this device must accept any interference received, including interference that may cause undesired operation.

Do not make any changes or modifications to the equipment unless otherwise specified in the manual. If such changes or modifications should be made, you could be required to stop operation of the equipment.

NOTE: This equipment has been tested and found to comply with the limits for a Class B digital device, pursuant to part 15 of the FCC Rules. These limits are designed to provide reasonable protection against harmful interference in a residential installation.

This equipment generates, uses and can radiate radio frequency energy and, if not installed and used in accordance with the instructions, may cause harmful interference to radio communications. However, there is no guarantee that interference will not occur in a particular installation. If this equipment does cause harmful interference to radio or television reception, which can be determined by turning the equipment off and on, the user is encouraged to try to correct the interference by one or more of the following measures:

- Reorient or relocate the receiving antenna.
- Increase the separation between the equipment and receiver.
- Connect the equipment into an outlet on a circuit different from that to which the receiver is connected.
- Consult the dealer or an experienced radio/TV technician for help.

CAN ICES-3 (B) / NMB-3 (B)

The apparatus shall not be exposed to dripping or splashing.
Batteries shall not be exposed to excessive heat such as sunshine, fire, or the like.
Dry batteries shall not be subjected to charging.



Only for European Union and EEA (Norway, Iceland and Liechtenstein)

This symbol indicates that this product is not to be disposed of with your household waste, according to the WEEE Directive (2012/19/EU) and national legislation. This product should be handed over to a designated collection point, e.g., on an authorized one-for-one basis when you buy a new similar product or to an authorized collection site for recycling waste electrical and electronic equipment (EEE). Improper handling of this type of waste could have a possible negative impact on the environment and human health due to potentially hazardous substances that are generally associated with EEE. At the same time, your cooperation in the correct disposal of this product will contribute to the effective usage of natural resources. For more information about where you can drop off your waste equipment for recycling, please contact your local city office, waste authority, approved WEEE scheme or your household waste disposal service. For more information regarding return and recycling of WEEE products, please visit www.canon-europe.com/weee.

Graphical symbols placed on the equipment

— — Direct current

DISPOSE OF USED BATTERIES ACCORDING TO LOCAL REGULATIONS.

Index

Numerics

- 12 sec., 16 sec. timer.....4
- 18% gray reflector.....37

A

- Accessory 15
- AF-assist beam 27, 86, 87, 89
- AI bounce flash 41, 42
- AI.B full-auto 42, 43, 46, 48
- AI.B lamp 54, 59
- AI.B semi-auto 42, 45, 56
- ANGLE SET 45, 54, 57
- Auto power off.....22, 85, 86
- Auto zoom adjustment to image sensor size.....26
- Av (Aperture-priority AE).....25

B

- Batteries..... 18
- Bounce..... 14, 41
 - Adapter 15, 63
 - Distance measurement start button.....43, 46, 49
 - Full-auto.....42, 43, 46, 48
 - Manual.....61, 92
 - Semi-auto42, 45, 56
- Bounce angle61
 - Compensation44, 45, 51, 91
 - Horizontal direction.....14
 - Maximum angle90
 - Setting button45, 54, 57
 - Upward direction.....14

C

- C.Fn..... 82, 83, 85
- Case 15
- Clear all 70, 84
- Clearing settings (Reverting to defaults)..... 40, 69
- Color temperature information transmission 26
- Creative Zone..... 29, 65, 71, 81
- Custom Functions (C.Fn) ... 82, 83, 85

D

- Distance indicator display... 24, 36, 85
- Distance measurement start button 43, 46, 49
- Double-click..... 51, 57, 91

E

- Effective flash metering range.. 12, 24
- E-TTL II flash metering..... 68
- E-TTL II/E-TTL autoflash..... 24, 25

F

- FE lock (FEL) 31
- Firing groups 76, 78
- Firing interval..... 18, 96
- First-curtain sync 68
- Flash control..... 66
- Flash coverage..... 34, 87
- Flash exposure compensation 30, 68, 78

- Flash exposure level..... 12, 30, 37
- Flash firing restriction..... 96
- Flash function settings..... 65
- Flash head (Light-emitting unit) 10
- Flash metering 68
- Flash mode 12, 13, 24, 36, 68
- Flash output..... 36
- Flash positioning..... 72
- Flash sync speed..... 25, 68
- Flash synchronization speed in Av mode..... 68
- Flash-ready lamp 21, 49, 77, 89
- Full-auto (AI.B-F) 42, 43, 46, 48
- Fully automatic flash photography .. 24
- G**
- Guide number 109
- H**
- High-speed sync 32, 78
- Hot shoe 20
- I**
- INDIVIDUAL RECEIVER 13, 79
- Individual receiver 79
- L**
- LCD panel..... 12
- Contrast..... 88
- Illumination 22, 87
- Illumination color 88
- Light distribution..... 87
- LOCK..... 22
- Lock function 22
- M**
- M (Manual exposure) 25
- M (Manual flash) 36
- Manual bounce..... 61, 92
- Manual flash..... 36, 79
- Memory function..... 75
- Metered manual flash..... 37
- Modeling flash 38
- N**
- Nomenclature..... 10
- Normal flash 18, 109
- Number of flashes 18
- O**
- Optical transmission wireless flash shooting..... 71
- Orientation (position).... 44, 45, 51, 91
- P**
- P (Program AE)..... 24
- P.Fn 82, 83, 88
- Personal Functions (P.Fn).. 82, 83, 88
- Power switch 21
- Q**
- Quick flash 18, 21, 89
- R**
- Receiver unit 13, 71
- Charge confirmation 77, 87
- Receiver unit setting 74

Recharging.....21

S

Safety precautions8

Second-curtain sync33

Semi-auto (AI.B-S).....42, 45, 56

Shooting distance36, 48, 63

Shutter speed.....25

Shutter sync settings.....68

Stand.....15

Sync speed25, 68

System map.....94

T

Temperature increase96

Test flash.....21, 77

Transmission channel74

Transmission distance72

Transmitter.....94

TTL autoflash.....110

Tv (Shutter-priority AE).....25

Type-A camera.....2

Type-B camera.....110

V

Vertical position.....44, 45, 51, 91

W

Warning.....52, 96

Wide panel.....35

Wireless button11, 74, 79

Wireless operation range.....72

Wireless settings74

Wireless shooting.....71

Z

Zoom34

Canon

The descriptions in this Instruction Manual are current as of December 2017. For information on the compatibility with any products introduced after this date, contact any Canon Service Center. For the latest version Instruction Manual, refer to the Canon Web site.