

CANDY

FORNI

ISTRUZIONI PER L'USO

IT

OVENS

USER INSTRUCTIONS

GB

HORNOS EMPOTRABLES

INSTRUCCIONES DE USO

ES

OVEN

GEBRUIKSAANWIJZING

NL

EINBAUBACKKÖFEN

BEDIENUNGSANLEITUNG

DE

FOURS ENCASTRABLES

NOTICE D'EMPLOI ET D'INSTALLATION

FR

FORNOS

MANUAL DE INSTRUÇÕES DE UTILIZAÇÃO

PT

PIEKARNIKI DO ZABUDOWY

INSTRUKJA OBSŁUGI

PL

TROUBY

NÁVOD K OBSLUZE

CZ

NAVODILO ZA UPORABO

VEČNAMENSKE VGRADNE PEČICE

SI

ФУРНИ

ИНСТРУКЦИИ ЗА ПОТРЕБИТЕЛЯ

BG

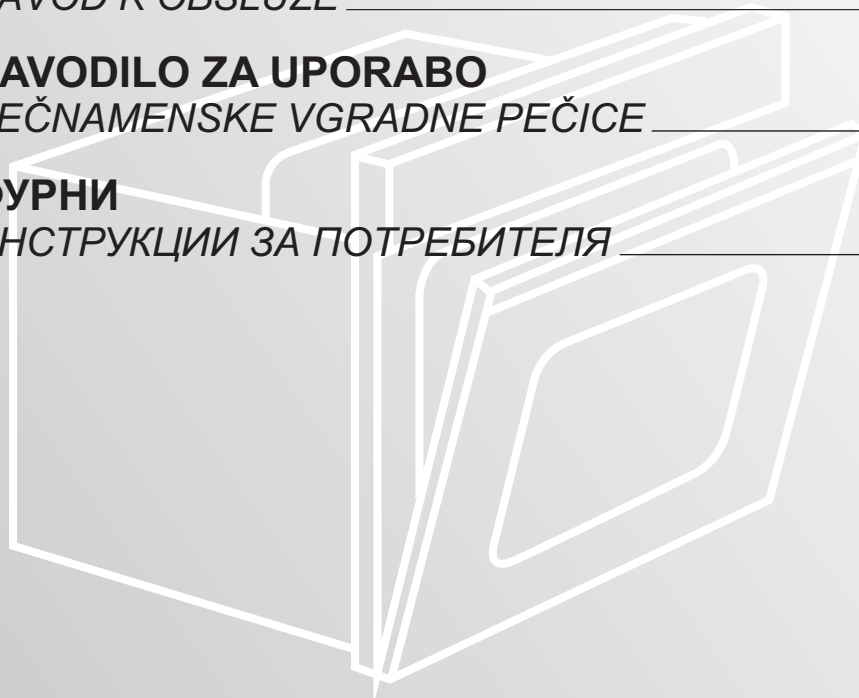

CONTENUTO	IT
Indicazioni Di Sicurezza	04
1. Avvertenze Generali	05
1.1 Dichiarazione Di Conformità	05
1.2 Informazioni Sulla Sicurezza	05
1.3 Installazione	05
1.4 Inserimento Del Mobile	05
1.5 Importante	05
1.6 Allacciamento Elettrico	05
1.7 Dotazione Del Forno (secondo Modello)	05
2. Consigli Utili	06
2.1 Griglie Forno - Sistema Di Arresto	06
2.2 La Cottura Al Grill	06
2.3 Secondo Modello Led Vision	06
2.4 Tempi Di Cottura	06
2.5 Pulizia E Manutenzione	06
2.6 La Funzione AQUACTIVA	07
2.7 Pulizia E Manutenzione	07
2.8 Servizio Assistenza Clienti	07
3. Contaminuti	08
3.1 Uso Del Contaminuti	08
3.2 Uso Del Temporizzatore	08
3.3 Regolazione Ora	08
3.4 Timer Elettronico A Sfiocamento	08
4. Istruzioni Per L'uso	09
5. Tabella Tempi Di Cottura	10-11

CONTENTS	GB
Safety Instructions	12
1. General Warnings	12
1.1 Declaration Of Compliance	13
1.2 Safety Hints	13
1.3 Installation	13
1.4 Fitting The Oven Into The Kitchen Unit	13
1.5 Important	13
1.6 Connecting To The Power Supply	13
1.7 Oven Equipment (according To The Model)	13
2. Useful Tips	14
2.1 Shelf Safety System	14
2.2 Grilling	14
2.3 The U-Cook Models	14
2.4 U-See	14
2.5 Self-cleaning Oven With Catalytic	14
2.6 AQUACTIVA Function	14
2.7 Cleaning And Maintenance	14
2.8 Service Centre	15
3. Timer	15
3.1 Using The Minute Timer	15
3.2 Using The End Of Cooking Timer	15
3.3 Setting The Correct Time	15
3.4 Use Of The Electronic Programmer	15
4. Operating Instructions	16
5. Tables Of Cooking Times	17-18

CONTENIDO	ES
Instrucciones Para Un Uso Seguro	19
1. Instrucciones Generales	19
1.1 Declaración De Conformidad	20
1.2 Información Sobre Seguridad	20
1.3 Instalación	20
1.4 Introducción Del Mueble	20
1.5 Importante	20
1.6 Conexión Eléctrica	20
1.7 Equipamiento Del Horno - Según El Modelo -	20
2. Consejos Útiles	21
2.1 Rejillas Horno - Sistema De Sujeción	21
2.2 La Cocción Al Grill	21
2.3 Los Modelos U-cook	21
2.4 Según Modelos U-see	21
2.5 Horno Autolimpiante Catalítico	21
2.6 Función Aquaactiva	21
2.7 Limpieza Y Mantenimiento	22
2.8 Asistencia Técnica	22
3. Minutero	22
3.1 Uso Del Minutero	22
3.2 Uso Del Temporizador	22
3.3 Ajuste De La Hora	22
3.4 Temporizador Táctil	22
4. Instrucciones De Uso	23
5. Tablas De Tiempos De Cocción	24-25

INHOUDSOPGAVE	NL
VEILIGHEIDSVOORSCHRIFTEN	26
1. Algemene Aanwijzingen	26
1.1 Lees Deze Handleiding Aandachtig	27
1.2 Veiligheidsvoorschriften	27
1.3 Installatie	27
1.4 Inbouw Van De Oven	27
1.5 Belangrijk	27
1.6 Elektrische Aansluiting	27
1.7 Uitrusting Van De Oven Afhankelijk Van Het Model	27
2. Nuttige Tips	28
2.1 Veiligheidssysteem Voor De Roosters	28
2.2 Grilleren	28
2.3 De U-cook Modellen	28
2.4 Afhankelijk Van Model:u-see	28
2.5 Zelfreinigende Ovenwanden	28
2.6 Aquactivafunctie	28
2.7 Schoonmaken En Onderhoud	28
2.8 Service Dienst	29
3. Kookwekker	29
3.1 Gebruik Van De Kookwekker	29
3.2 Gebruik Van De Timer Met Uitschakelfunctie	29
3.3 De Juiste Tijd Instellen	29
3.4 Elektronische Programma's Gebruiken	29
4. Instructies Voor Het Gebruik Van De Oven	30
5. Baktijden En-temperaturen Voor Geventileerde Oven	31

INHALTSVERZEICHNIS	DE
SICHERHEITSVORSCHRIFTEN	32
1. Allgemeine Hinweise	32
1.1 Konformitätserklärung:	32
1.2 Sicherheitshinweise	33
1.3 Installation	33
1.4 Einbau In Den Schrank	33
1.5 Wichtig	33
1.6 Elektrischer Anschluß	33
1.7 Ofenausstattung (je Nach Modell)	33
2. Einige Nützliche Hinweise	34
2.1 Kippgesicherte Gitterroste	34
2.2 Grillen	34
2.3 The U-cook Models	34
2.4 Beleuchtungssystem U-see - Je Nach Modell	34
2.5 Katalytisches Selbstreinigungssystem	34
2.6 Aquactiva Funktion	34
2.7 Reinigung Und Wartung	34
2.8 Technischer Kundendienst	35
3. Minutenzähler	35
3.1 Minutenzähler	35
3.2 Benutzung Des Timers Für Backzeitende	35
3.3 Einstellung Der Richtigen Uhrzeit	35
3.4 Touch Timer	35
4. Bedienungsanleitung	36
5. Garzeiten	37-38

SOMMAIRE	FR
CONSEILS DE SÉCURITÉ	39
1. Instructions Generales	39
1.1 Declaration De Conformité	39
1.2 Consignes De Sécurité.....	40
1.3 Installation	40
1.4 Mise En Place Du Four Dans Son Meuble	40
1.5 Important	40
1.6 Alimentation Electrique	40
1.7 Important	40
1.8 Equipement Du Four Equipement Different Selon Le Type De Four	40
2. Consignes Utiles	41
2.1 Grilles Du Four, Nouveau Système D'arrêt	41
2.2 La Cuisson Au Grill	41
2.3 Selon Modèle Le Pack U-cook	41
2.4 Selon Modèle U-see	41
2.5 Four Autonettoyant Par Catalyse	41
2.6 Fonction Aquaactiva	41
2.7 Conseils De Nettoyage Et D'entretien	42
2.8 Assistance Technique	42
3. Minuteur	42
3.1 Utilisation Du Minuteur Sonore	42
3.2 Utilisation Du Minuteur Coupe-circuit.....	42
3.3 Reglage De L'heure	42
3.4 Horloge À Commande Sensitive	42
4. Instructions Pour L'utilisation	43
5. Temps De Cuisson	44-45

SAFETY INSTRUCTIONS

WARNING: The appliance and its accessible parts become hot during use. Care should be taken to avoid touching heating elements.

- Children under 8 Year of age must be kept away from the appliance unless they are continuously supervised.
- This appliance can be used by children aged from 8 years and above and persons with reduced physical, sensory or mental capabilities or lack of experience and knowledge if they have been given supervision or instruction concerning use of the appliance in a safe way and understand the hazards involved.
- Children must not play with the appliance.
- Cleaning and user maintenance shall not be made by children without supervision.
- During use the appliance becomes hot. Care should be taken to avoid touching heating elements inside the oven.

WARNING: Accessible parts may become hot during use. Young children must be kept away.

- Do not use harsh abrasive cleaners or sharp metal scrapers to clean the oven door glass since they can scratch the surface, which may result in shattering of the glass.
- The oven must be switched off before removing the guard, after cleaning, the guard must be replaced in accordance with the instructions.
- Only use the temperature probe recommended for this oven.
- Do not use a steam cleaner for cleaning operations.
- **WARNING:** Avoid possibility of electric shock - ensure the appliance is switched off before replacing the lamp.
- The means for disconnection must be incorporated in the fixed wiring in accordance with the wiring rules.
- The instructions state the type of cord to be used, taking into account the temperature of the rear surface of the appliance.
- If the supply cord is damaged, it must be replaced by a special cord or assembly available from the manufacturer or its service agent.
- **CAUTION:** In order to avoid a hazard due to inadvertent resetting of the thermal cutout, this appliance must not be supplied through an external switching device, such as a timer, or connected to a circuit that is regularly switched on and off by the utility.
- **CAUTION:** Accessible parts may be hot when the grill is in use. Young children must be kept away.
- Excess spillage must be removed before cleaning.
- During self-cleaning pyrolytic operation the surfaces may get hotter than usual and children **MUST** be kept away.



This appliance is marked according to the European directive 2012/19/EU on Waste Electrical and Electronic Equipment (WEEE). WEEE contains both polluting substances (which can cause negative consequences for the environment) and basic components (which can be re-used). It is important to have WEEE subjected to specific treatments, in order to remove and dispose properly all pollutants, and recover and recycle all materials. Individuals can play an important role in ensuring that WEEE does not become an environmental issue; it is essential to follow some basic rules:

- WEEE shall not be treated as household waste.
- WEEE shall be handed over to the relevant collection points managed by the municipality or by registered companies. In many countries, for large WEEE, home collection could be present.
- When you buy a new appliance, the old one may be returned to the retailer who has to collect it free of charge on a one-to-one basis, as long as the equipment is of equivalent type and has the same functions as the supplied equipment.

ENERGY SAVING AND RESPECTING THE ENVIRONMENT

Where possible, avoid pre-heating the oven and always try to fill it. Open the oven door as infrequently as possible, because heat from the cavity disperses every time it is opened. For a significant energy saving, switch off the oven between 5 and 10 minutes before the planned end of the cooking time, and use the residual heat that the oven continues to generate. Keep the seals clean and in order, to avoid any heat dispersal outside of the cavity. If you have an electric contract with an hourly tariff, the "delayed cooking" programme makes energy saving more simple, moving the cooking process to start at the reduced tariff time slot.

1. GENERAL WARNINGS

Thank you for choosing one of our products. To get the most out of your oven we recommend that you:

- Read the notes in this manual carefully: they contain important instructions on how to install, use and service this oven safely.
- Keep this booklet in a safe place for easy, future reference.

All accessible parts are hot when the appliance is in operation, take care to not touch these elements.

When the oven is first switched on it may give out acrid smelling fumes. This is because the bonding agent for insulating panels around the oven has been heated up for the first time.

This is a completely normal, if it does occur you merely have to wait for the fumes to clear before putting the food into the oven.

An oven by its very nature becomes very hot. Especially the glass of the oven door.

1.1 DECLARATION OF COMPLIANCE

The parts of this appliance that may come into contact with foodstuffs comply with the provisions of EEC Directive 89/109.

By placing the **CE** mark on this product, we are confirming compliance to all relevant European safety, health and environmental requirements which are applicable in legislation for this product.

When you have unpacked the oven, make sure that it has not been damaged in any way. If you have any doubts at all, do not use it: contact a professionally qualified person. Keep packing materials such as plastic bags, polystyrene, or nails out of the reach of children because they are dangerous for children.

1.2 SAFETY HINTS

•The oven must be used only for the purpose for which it was designed: it must only be used for cooking food. Any other use, e.g. as a form of heating, is an improper use of the oven and is therefore dangerous.

•The manufacturers cannot be held responsible for any damage caused by improper, incorrect or unreasonable use. **When using any electrical appliance you must follow a few basic rules.**

– Do not pull on the power cable to remove the plug from the socket.

– Do not touch the oven with wet or damp hands or feet.

– Do not use the oven unless you are wearing something on your feet.

– It is not generally a good idea to use adapters, multiple sockets for several plugs and cable extensions.

– If the oven breaks down or develops a fault switch it off at the mains and do not touch it.

•If the cable is at all damaged it must be replaced promptly.

When replacing the cable, follow these instructions. Remove the power cable and replace it with one of the H05RRF, H05VV-F, H05V2V2-F type. The cable must be able to bear the electrical current required by the oven. Cable replacement must be carried out by properly qualified technicians. The earthing cable (yellow-green) must be 10 mm longer than the power cable.

Use only an approved service centre for repairs and ensure that only original parts are used. If the above instructions are not adhered to the manufacturers cannot guarantee the safety of the oven.

•**Do not line the oven walls with aluminium foil or single-use protection available from stores. Aluminium foil or any other protection, in direct contact with the hot enamel, risks melting and deteriorating the enamel of the insides.**

1.3 INSTALLATION

Installation is the customer's responsibility. The manufacturers have no obligation to carry this out. If the assistance of the manufacturer is required to rectify faults arising from incorrect installation, this assistance is not covered by the guarantee.

The installation instructions for professionally qualified personal must be followed. Incorrect installation may cause harm or injury to people, animals or belongings. The manufacturer cannot be held responsible for such harm or injury.

1.4 FITTING THE OVEN INTO THE KITCHEN UNIT

Fit the oven into the space provided in the kitchen unit; it may be fitted underneath a work top or into an upright cupboard. Fix the oven in position by screwing into place, using the four fixing holes in the frame. (Fig. on last page).

To locate the fixing holes, open the oven door and look inside. To allow adequate ventilation, the measurements and distances indicated in the diagram on last page must be adhered to when fixing the oven.

Note: For ovens that are combined with a hob unit the instructions contained in the manual for the hob unit must be followed.

1.5 IMPORTANT

If the oven is to work properly, the kitchen housing must be suitable. The panels of the kitchen unit that are next to the oven must be made of a heat resistant material. Ensure that the glues of units made of veneered wood can withstand temperatures of at least 120 °C. Plastics or glues that cannot withstand such temperatures will melt and deform the unit. Once the oven has been lodged inside the unit, the electrical parts must be completely insulated. This is a legal safety requirement. All guards must be firmly fixed into place so that it is impossible to remove them without using special tools.

Remove the back of the kitchen unit to ensure an adequate current of air circulates around the oven. The hob must have a rear gap of at least 45 mm.

1.6 CONNECTING TO THE POWER SUPPLY

Plug into the power supply. Ensure first that there is a third contact that acts as earthing for the oven. **The oven must be properly earthed.**

If the model of oven is not fitted with a plug, fit a standard plug to the power cable. It must be able to bear the power supply indicated on the specifications plate. The earthing cable is yellowgreen. The plug must be fitted by a properly qualified person. If the socket and the plug are incompatible the socket must be changed by a properly qualified person. A properly qualified person must also ensure that the power

cables can carry the current required to operate the oven.

An ON/OFF switch may also be connected to the power supply. The connections must take account of the current supplied and must comply with current legal requirements. The yellow-green earthing cable must not be governed by the ON/OFF switch. The socket or the ON/OFF switch used for connecting to the power supply must be easily accessible when the oven has been installed.

Important: During installation, position the power cable in such a way that it will not be subjected to temperatures of above 50°C at any point.

The oven complies with safety standards set by the regulatory bodies.

The oven is safe to use only if it has been adequately earthed in compliance with current legal requirements on wiring safety. You must ensure that the oven has been adequately earthed.

The manufacturers cannot be held responsible for any harm or injury to persons, animals or belongings caused by failure to properly earth the oven.

WARNING: the voltage and the supply frequency are showed on the rating plate (fig. on last page).

The cabling and wiring system must be able to bear the maximum electric power required by the oven. This is indicated on the specifications plate. If you are in any doubt at all, use the services of a professionally qualified person.

1.7 OVEN EQUIPMENT (according to the model)

It is necessary to do an initial cleaning of the equipment before the first use of each of them. Wash them with a sponge. Rinse and dry off.

The simple shelf can take moulds and dishes.

The tray holder shelf is especially good for grilling things. Use it with the drip tray.

The special profile of the shelves means they stay horizontal even when pulled right out. There is no risk of a dish sliding or spilling.

The drip tray catches the juices from grilled foods. It is only used with the Grill, Rotisserie, or Fan Assisted Grill ; remove it from the oven for other cooking methods.

Never use the drip tray as a roasting tray as this creates smoke and fat will spatter your oven making it dirty.

The pizza set is designed for pizza cooking. In order to obtain the best results the set must be used together with Pizza function.

The tray holder

The tray holder shelf is ideal for grilling. Use it in conjunction with the drip tray. A handle is included to assist in moving the both accessories safely. Do not leave the handle inside the oven.

Removing and cleaning wire racks

- 1- Remove the knurled nuts by turning them counter clockwise.
- 2- Remove the wire racks by pulling them towards yourself.
- 3- To clean the wire racks either put them in the dishwasher or use a wet sponge, ensuring that they are dried afterwards.
- 4- After the cleaning process install the wire racks in reverse order.
- 5- Replace the knurled nuts.

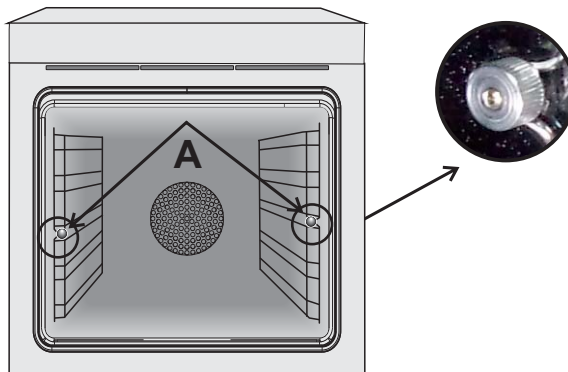

2. USEFUL TIPS

2.1 SHELF SAFETY SYSTEM

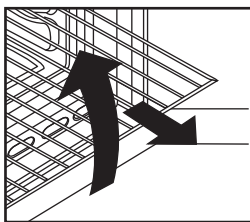

The oven features a new shelf safety system.

This allows you to pull out the oven shelves when inspecting the food without danger of food spillages or shelves falling accidentally out of the oven.

To remove the shelves pull out and lift.

2.2 GRILLING

Grilling makes it possible to give food a rich brown colour quickly. For browning we recommend that you insert the grill onto the fourth level, depending on the proportions of the food (see fig. page 7).

Almost all food can be cooked under the grill except for very lean game and meat rolls.

Meat and fish that are going to be grilled should first be lightly doused with oil.

2.3 The U·COOK MODELS

U·COOK Ovens have an electronic control of the fan speed, called and patented VARIOFAN. During the cooking, this system changes automatically the speed of the fan (in multifunction mode) in order to optimize the air flow and the internal temperature in the cavity of the oven.



All U·COOK ovens feature the **Soft Cook** function.

This allows a management of the distribution of moisture and temperature. It reduces the loss of humidity of the 50 %, which guarantees the food remains tender and tastes better. This a delicate cooking is recommended for the baking of the bread and pastry.



It reduces the time of preheating of ovens: only 8 minutes to reach 200 degrees Celsius.



It gives the possibility of setting level and intensity of grilling, up to 50 % more power in comparison with a traditional multifunction oven.

Some ovens are equipped with the new doorj **"WIDE DOOR"** which has a bigger window area, this allows better maintenance and a improved thermal insulation.

2.4 According to the model U·SEE

Is an illumination system which replaces the traditional « light bulb ». 14 LED lights are integrated within the door. These produce white high quality illumination which enables to view the inside of the oven with clarity without any shadows on all the shelves.

U·SEE

Advantages :

System, besides providing excellent illumination inside the oven, lasts longer than the traditional light bulb its easier and to maintain and most of all saves energy.

- Optimum view
- Long life illumination
- Very low energy consumption, -95% in comparison with the traditional illumination High

"Appliance with white light LED of the 1M Class according to IEC 60825- 1:1993 + A1: 1997 + A2: 2001 (equivalent to EN 60825-1: 1994 + A1: 2002 + A2: 2001); the maximum light power emitted λ 459nm < 150uW.

Not observed directly with optical instruments. "



2.5 SELF-CLEANING OVEN WITH CATALYTIC

Special self-cleaning panels covered in a micro-porous coating are available as optional extras for all models. If they are fitted, the oven no longer needs to be cleaned by hand.

The fat that is splattered onto the sides of the oven during roasting is eliminated by the microporous coating which breaks the fat down by catalysis and transforms it into gas.

Excessive splattering may nevertheless block the pores and therefore hinder self-cleaning. The self-cleaning capacity may be restored by switching on the empty oven to maximum for about 10-20 minutes.

Do not use abrasive products, metal cleaning wads, sharp objects, rough cloths, or chemical products and detergents that may permanently damage the catalytic lining.

It is a good idea to use deep roasting trays to roast fatty foods such as joints of meat etc. and to put a tray underneath the grill to catch surplus fat. If the walls of the oven are so thickly coated in grease that the catalytic lining is no longer effective remove surplus grease with a soft cloth or sponge soaked in hot water.

The lining must be porous for self-cleaning to be effective.

N.B.: All catalytic linings currently on the market have a working life of about 300 hours. They should therefore be replaced after about 300 hours.

2.6 AQUACTIVA FUNCTION

The Aquactiva procedure uses steam to help remove remaining fat and food particles from the oven.

1. Pour 300 ml of water into the Aquactiva container at the bottom of the oven.

2. Set the oven function to Static () or Bottom () heater

3. Set the temperature to the Aquactiva icon 

4. Allow the program to operate for 30 minutes.

5. After 30 minutes switch off the program and allow the oven to cool down.

6. When the appliance is cool, clean the inner surfaces of the oven with a cloth.

Warning:

Make sure that the appliance is cool before you touch it.

Care must be taken with all hot surfaces as there is a risk of burns.

Use distilled or drinkable water.



2.7 CLEANING AND MAINTENANCE

Never use abrasive cleaners, wire wool or sharp objects to clean the glass oven door.

Clean the stainless steel and enamelled surfaces with warm, soapy water or with suitable brand products. On no account use abrasive powders that may damage surfaces and ruin the oven's appearance. It is very important to clean the oven each time that it is used. Melted fat is deposited on the sides of the oven during cooking. The next time the oven is used this fat could cause unpleasant odours and might even jeopardise the success of the cooking. Use hot water and detergent to clean; rinse out thoroughly.

To make this chore unnecessary all models can be lined with catalytic self-cleaning panels: these are supplied as an optional extra (see the section SELF-CLEANING OVEN WITH CATALYTIC LINING).

Use detergents and abrasive metal pads like «brillo pads» for the stainless steel grills.

The glass surfaces as the top, oven door and warming compartment door must be cleaned when they are cold. Damage that occurs to them because this rule was not adhered to are not covered by the guarantee.

To replace the interior light:

- switch off the mains power supply and unscrew bulb. Replace with an identical bulb that can withstand very high temperatures

2.8 SERVICE CENTRE

Before calling the Service Centre

If the oven is not working, we recommend that:

you check that the oven is properly plugged into the power supply.

If the cause of the fault cannot be detected:

disconnect the oven from the mains, do not touch the oven and call the after sales service.

Before calling the Service Centre remember to make a note of the serial number on the specifications plate (see fig. On last page).

The oven is supplied with a guarantee certificate that ensures that it will be repaired free of charge by the Service Centre

3. TIMER

3.1 USING THE MINUTE TIMER

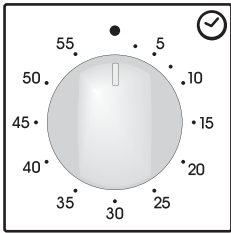

To set the cooking time, turn dial one complete revolution and then position the index to the required time. When the time has lapsed, the signal will ring for a few seconds.

3.2 USING THE END OF COOKING TIMER

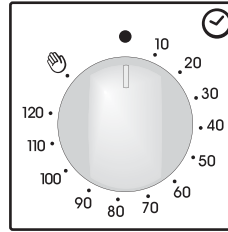

This control enables to set the desired cooking time (max. 120 min.) the oven will automatically switch off at the end of the set time.

The timer will count down from the set time return to the 0 position and switch off automatically.

For normal use of oven set the timer to the position.

To set the oven ensure the timer is not on the 0 position.

3.3 SETTING THE CORRECT TIME



WARNING : the first operation to carry out after the oven has been installed or following the interruption of power supply (this is recognizable the display pulsating and showing 12:00) is setting the correct time. This is achieved as follows.















- Push the central button.
- Set time with "-" "+" buttons.
- Release all buttons.

ATTENTION: The oven will only operate providing the clock is set.

3.4 USE OF TOUCH CONTROL CLOCK PROGRAMMER

FUNCTION	HOW TO ACTIVATE IT	HOW TO SWITCH IT OFF	WHAT IT DOES	WHAT IT IS FOR
KEY LOCK	<ul style="list-style-type: none"> •Child Lock function is activated by touching Set (+) for a minimum of 5 seconds. From this moment on all other function are locked and the display will flash STOP and preset time intermittently. 	<ul style="list-style-type: none"> •Child Lock function is deactivated by touching touchpad Set (+) again for a minimum of 5 seconds. From this moment on all functions are selectable again. 		
MINUTE MINDER 	<ul style="list-style-type: none"> •Push the central button 1 times •Press the buttons "-" "+" to set the required time •Release all the buttons 	<ul style="list-style-type: none"> •When the set time as elapsed an audible alarm is activated (this alarm will stop on its own, however it can be stopped immediately by pressing the button) SELECT. 	<ul style="list-style-type: none"> •Sounds an alarm at the end of the set time. •During the process, the display shows the remaining time. 	<ul style="list-style-type: none"> •Allows to use the oven as alarm clock (could be activated either with operating the oven or with out operating the oven)
COOKING TIME 	<ul style="list-style-type: none"> •Push the central button 2 times • Press the buttons "-" or "+" to set the length of cooking required •Release all buttons • Set the cooking function with the oven function selector 	<ul style="list-style-type: none"> •Push any button to stop the signal. Push the central button to return to the clock function 	<ul style="list-style-type: none"> • It allows to preset the cooking time required for the recipe chosen. • To check how long is left to run press the SELECT button 2 Times. • To alter/change the preset time press SELECT and "-" "+" buttons. 	<ul style="list-style-type: none"> •When the time is elapsed the oven will switch off automatically. Should you wish to stop cooking earlier either turn the function selector to 0, or set time to 0:00 (SELECT and "-" "+" buttons)
END OF COOKING 	<ul style="list-style-type: none"> •Push the central button 3 times •Press the buttons "-" "+" to set the time at which you wish the oven to switch off •Release the buttons •Set the cooking function with the oven function selector 	<ul style="list-style-type: none"> •At the time set, the oven will switch off. To switch off manually, turn the oven function selector to position 0. 	<ul style="list-style-type: none"> •Enables you to set the end of cooking time •To check the preset time push the central button 3 times •To modify the preset time press buttons SELECT + "-" "+" 	<ul style="list-style-type: none"> •This function is typically used with "cooking time" function. For example if the dish has to be cooked for 45 minutes and needs to be ready by 12:30, simply select the required function, set the cooking time to 45 minutes and the end of cooking time to 12:30. •At the end of the cooking set time, the oven will switch off automatically and an audible alarm will ring. •Cooking will start automatically at 11:45 (12:30 minus 45 mins) and will continue until the pre-set end-of-cooking-time, when the oven will switch itself off automatically. WARNING. If the END of cooking is selected without setting the length of cooking time, the oven will start cooking immediately and it will stop at the END of cooking time set.

4. OPERATING INSTRUCTIONS

Function dial	Temperature pre-set and setting. (Model with electronic programmer) (Type A)	Thermostat dial	Function
			Turns on the oven light This will automatically activate the cooling fan (on fan cooled models only)
			Defrosting When the dial is set to this position. The fan circulates air at room temperature around the, frozen food so that it defrosts in a few minutes without the protein content of the food being changed or altered.
Sprinter 	MAX	MAX	Super Grill This function allows to set food crunchiness. The Super Grill function is characterized by a 50% power increase in comparison to the standard grill.
 *	220 50 ÷ 240	50 ÷ MAX	Natural convection Bottom and top oven elements are used. This is the traditional form of baking and roasting. It is ideal for roasting joints of meat and game, baking biscuits and apples and making the food nice and crunchy.
 	200 50 ÷ 230	50 ÷ MAX	Fan cooking Both top and bottom heating elements are used with the fan circulating the air inside the oven. We recommend you use this method for poultry, pastries, fish and vegetables. Heat penetrates into the food better and both the cooking and preheating times are reduced. You can cook different foods at the same time with or without the same preparation in one or more positions. This cooking method gives even heat distribution and the smells are not mixed. Allow about ten minutes extra when cooking foods at the same time.
Soft cook 	200 50 ÷ 230	-	Soft Cook (a) Soft Cook is the function for the confectionery and the bread. Thanks to its reduced fan speed, this function increases oven internal damp. The increased damp creates the ideal conditions of cooking for those foods that need to maintain an elastic consistence while they are cooking (ex. cakes, bread, biscuits) avoiding surface breakages.
	160 50 ÷ 220	50 ÷ MAX	Fan plus lower element This function is ideal for delicate dishes (pies-souffle).
	Level 4 1 ÷ 4	50 ÷ MAX	GRILL: use the grill with the door closed. The top heating element is used alone and you can adjust the temperature. Five minutes preheating is required to get the elements red-hot. Success is guaranteed for grills, kebabs and gratin dishes. White meats should be put at a distance from the grill; the cooking time is longer, but the meat will be tastier. You can put red meats and fish fillets on the shelf with the drip tray underneath.
Super grill 	Level 4 1 ÷ 4	50 ÷ MAX	SUPER GRILL: the oven has two grill positions Grill : 2200 W Grill SUPER : 3000 W
	190 180 ÷ 200	50 ÷ 200	FAN ASSISTED GRILL (a): use the turbo-grill with the door closed. The top heating element is used with the fan circulating the air inside the oven. Preheating is necessary for red meats but not for white meats. Ideal for cooking thick food items, whole pieces such as roast pork, poultry, etc. Place the food to be grilled directly on the shelf centrally, at the middle level. Slide the drip tray under the shelf to collect the juices. Make sure that the food is not too close to the grill. Turn the food over halfway through cooking.
	Level 4 1 ÷ 4	50 ÷ 200	Grill/spit element. This is used for roasting on the spit.
	220	50 ÷ MAX	Function Pizza This function with hot air circulated in the oven ensure perfect result for dishes such as pizza or focaccia.
COOK light  *	190 180 ÷ 200	50 ÷ 200	The " COOK LIGHT " function allows you to cook in a healthier way, by reducing the amount of fat or oil required. Thanks to the use of the grill and fan combined with a pulsating cycle of air, it will retain the moisture content of the food, grilling the surface and using a shorter cooking time, without compromising on taste. It is particularly suitable for cooking meat, roasted vegetables and omelettes. The cycle of pulsed air keeps the humidity inside the oven and the moisture content of the food, preserving the nutritional values and ensuring a rapid uniform cooking process. Try all your recipes and reduce the amount of dressing you usually use and experience the lightness of this new function!

(a) on some models : function with "Vario Fan" is the exclusive system developed by Candy to optimize the cooking results, temperature management and damp management. The Vario Fan system is a self-activating system that changes automatically fan speed when a fan function is chosen: the fan functions are the one inside the outlined area on control panel.

* Tested in accordance with the CENELEC EN 60350-1 used for definition of energy class.



SUGGESTED RECIPES

Vegetable Muffins

Ingredients :

- 200 g of courgettes
- 200 g of potatoes
- 200 g of sweet potatoes
- 1 red pepper
- 1 yellow pepper
- 100 g of provolone cheese
- 1 teaspoon paprika
- 50 g of parmesan cheese
- 20 g of breadcrumbs

• Cut the courgettes and peppers and dice the potatoes, boil for a few minutes on hob top. Cut and stir fry the other vegetables for 5 minutes in a pan with olive oil and paprika, salt and pepper.

Once the potatoes are boiled mash and add to the other vegetables and chopped provolone.

In the meantime, prepare a mixture of breadcrumbs and parmesan cheese, mix half of it into the vegetables.

Flour the muffin molds and fill to the brim, put the remaining of bread and cheese mixture on the top and add a little olive oil. Bake in the oven with the COOK LIGHT function at 180 degrees for 15-20 minutes, until they are beautifully golden in colour.

Autumn Baked Frittata

Ingredients:

- 6 eggs
- 10 courgette flowers
- 1 boiled potato
- 1 slice of boiled pumpkin
- 200 g of parmesan cheese
- turmeric
- 6 tablespoons of milk

• Cut and boil 1 potato. Cut the pumpkin into slices and place on a baking sheet, put into the oven at 160 degrees for approximately 20 minutes.

Once cooked, mash with a fork.

Beat the eggs and add the boiled potato and the crushed pumpkin, milk, parmesan cheese, turmeric, salt and pepper.

Mix all the ingredients together and add the courgette flowers, ensure that they are cleaned and cut into small pieces.

Pour the mixture into the tin and bake with the COOK LIGHT function in the oven preheated at 180 for 20 minutes.

5. TABLES OF COOKING TIMES

The overall suggested cooking times set out below are intended as a rough guide only. They may in fact vary according to the quality, the freshness, the size and the thickness of the food cooked and of course cooking time is also partly a matter of taste. Let the food stand for a few minutes before serving because the ingredients continue cooking after they have been removed from the oven.

HANDY TIP: Lower the temperature so as to avoid the surface of the food becoming hard and dry.

Shelf position

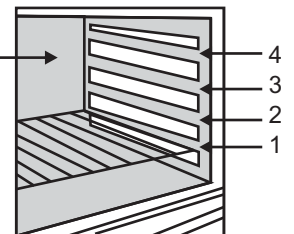

Food	Quantity	Static electric oven			Electric fan oven			Remarks
		Shelf	Time of cooking in minutes	Oven temperature	Shelf	Time of cooking in minutes	Oven temperature	
• Pasta								
Lasagne	Kg 3,5	2	70 ÷ 75	220	2	60 ÷ 65	200	Put the lasagne into an unheated oven
Cannelloni	Kg 1,8	2	50 ÷ 60	220	2	40 ÷ 50	200	Put the cannelloni into an unheated oven
Oven baked pasta	Kg 2,5	2	55 ÷ 60	220	2	45 ÷ 50	200	Put the oven baked pasta into an unheated oven
• Baking (not cakes)								
Bread	Kg 1 di pasta	2	35 10 (pre-heating)	200	2	30 ÷ 35 10 (pre-heating)	180	Form the dough into a loaf and make a cross with a knife on top of the dough leave the dough to rise for at least 2 hours. Grease the baking tin and put the dough in the middle of it.
Pizza	Kg 1	1	25 ÷ 35	190	1	20 ÷ 25	190	Warm the oven for 15 minutes and place the pizzas on the greased baking tray. Garnish them with tomatoes, mozzarella, ham, oil, salt and origano.
Pastry (frozen) vol au vents	n° 24	1	30 ÷ 35	220	2	25 ÷ 30	200	Place 24 vol au vents in the oven and bake.
Focaccia (n° 4)	gr. 200 of dough each	2	25 ÷ 30	200	2	20 ÷ 25	180	Warm the oven for 15 minutes, grease the baking tray, season the 4 focaccia with oil and salt and leave them to rise at room temperature for at least 2 hours before putting them in the oven.
• Meat								
All meats can be roasted in shallow or deep roasting trays. It is advisable to cover the shallow trays to avoid splattering the sides of the oven with grease. The roasting times are the same whether the meat has been covered up or not.								
Whole joint of beef	Kg 1	3	70 ÷ 80	220	3	50 ÷ 60	200	Put the meat into a deep Pyrex dish and season with salt and pepper; turn the meat half way through cooking.
Joint of deboned	Kg 1	2	100 ÷ 110	220	2	80 ÷ 90	200	Cook the meat in a covered Pyrex dish with herbs, spice, oil and butter.
Joint of deboned veal	Kg 1,3	1	90 ÷ 110	220	2	90 ÷ 100	200	Cook as indicated above
Joint of fillet of beef	Kg 1	2	80 ÷ 90	220	2	80 ÷ 90	200	Cook as indicated above.

5. TABLES OF COOKING TIMES

Food	Quantity	Static electric oven			Electric fan oven			Remarks
		Shelf	Time of cooking in minutes	Oven temperature	Shelf	Time of cooking in minutes	Oven temperature	
• Rabbits and Poultry								
Guinea fowl	Kg 1-1,3	2	60 ÷ 80	220	2	60 ÷ 70	200	Place the guinea fowl in a deep Pyrex or pottery dish with very little oil and season with herbs and spices.
Chicken	Kg 1,5-1,7	2	110 ÷ 120	220	2	100 ÷ 110	200	Follow the procedure for cooking the guinea fowl.
Rabbit pieces	Kg 1-1,2	2	55 ÷ 65	220	2	50 ÷ 60	200	Put all the pieces of the same size in the glazed tray. Season with herbs and spices. Turn the pieces as and when required.
• Cakes								
Coconut cake baked in a tin		1	55	180	1	50	160	Use a tin that is 22 cm deep. Pre-heat for 10 mins.
Sponge cake		1	55	175	1	40 ÷ 45	160	Use a tin that is 22 cm deep. Pre-heat for 10 mins.
Carrot cake baked in a tin		1	65	180	1	50 ÷ 60	160	Use a tin that is 22 cm deep. Pre-heat for 10 mins.
Apricot pie	700 gr	1	40	200	2	30 ÷ 35	180	Use a tin that is 22 cm deep. Pre-heat for 10 mins.
• Vegetable								
Fennel	800 gr	1	70 ÷ 80	220	1	60 ÷ 70	200	Cut the fennel into four pieces, add butter, salt and potatoes if required and place in a Pyrex face up. Cover the dish.
Courgettes	800 gr	1	70	220	1	60 ÷ 70	200	Slice the courgettes, place in a Pyrex dish and add butter and salt.
Potatoes	800 gr	2	60 ÷ 65	220	2	60 ÷ 65	200	Cut the potatoes into equal parts and place in a Pyrex dish. Season with salt, origano and rosemary. Cook in oil.
Carrots	800 gr	1	80 ÷ 85	220	1	70 ÷ 80	200	Slice the carrots, place in a Pyrex dish and cook.
• Grilling								
Place the food to be grilled underneath the infra-red grill. Warning: When the grill is on it takes on a bright red colour. Place the tray underneath the grill to collect juices and fat from the food being grilled.								
Squares of bread for toasting	4 pieces	4	5 (5 to heat up grill)	Grill	4	5 (10 to heat up grill)	Grill	Lay the bread on the grill tray. When one side of the bread has been toasted, turn over and toast the other side. Remember: keep the toast warm at the bottom of the oven until you are ready to serve it.
Toasted sandwiches	4	3	10 (10 to heat up grill)	Grill	3	5/8 (10 to heat up grill)	Grill	Lay the bread on the grill tray. When one side of the sandwich has been toasted, turn over and toast the other side.
Sausages	n°6 / Kg 0,9	4	25/30 (5 to heat up grill)	Grill	4	15/20 (10 to heat up grill)	Grill	Cut the sausages in half and lay them face down on the grill. Half way through grilling turn them over. Every so often, check that they are being cooked equally all over. (If this is not happening, turn and reposition the ones being cooked either less or more than the others.
Ribs of beef	n°4 / Kg 1,5	4	25 (5 to heat up grill)	Grill	4	15/20 (10 to heat up grill)	Grill	Make sure that the ribs of beef are exposed to the full effect on the main grill.
Chicken legs	n°4 / Kg 1,5	3	50/60 (5 to heat up grill)	Grill	3	50/60 (10 to heat up grill)	Grill	Turn them over twice during grilling
• Fish								
Trout	3 whole trout or / Kg 1	2	40 ÷ 45	220	2	35 ÷ 40	200	Cover the trout with salt, oil and onions and cook in a Pyrex dish.
Salmon	700 g 2,5 cm slice	2	30 ÷ 35	220	2	30 ÷ 25	200	Cook the salmon in an open Pyrex dish with salt, pepper and oil.
Sole	Kg 1	2	40 ÷ 45	220	2	35 ÷ 40	200	Cook the sole with salt and a spoonful of oil.
Bream	2 whole ones	2	40 ÷ 45	220	2	35 ÷ 40	200	Cook the bream in oil and salt in a covered dish.
• Fruit								
Whole apples	Kg 1	1	45 ÷ 55	220	2	45 ÷ 55	200	Bake the fruit in an open Pyrex or earthenware dish. Leave it to cool inside the oven.
Pears	Kg 1	1	45 ÷ 55	220	2	45 ÷ 55	200	Follow procedure above.
Peaches	Kg 1	1	45 ÷ 55	220	2	45 ÷ 55	200	Follow procedure above.

INSTALLAZIONE	IT
INSTALLATION	GB
INSTALACIÓN	ES
INSTALLATIE	NL
INSTALLATION	DE
VGRADNJA	SI

INSTALLATION	FR
INSTALAÇÃO	PT
INSTALACJA	PL
INSTALACE	CZ
МОУТАЖ	БГ

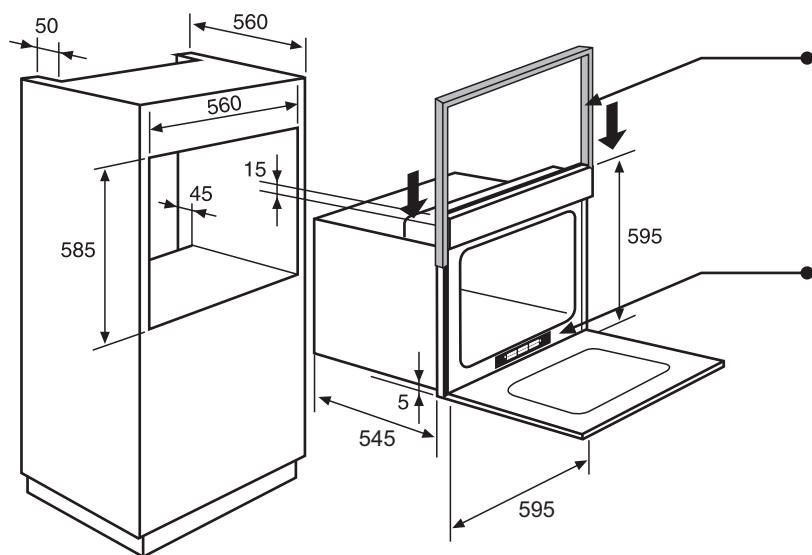
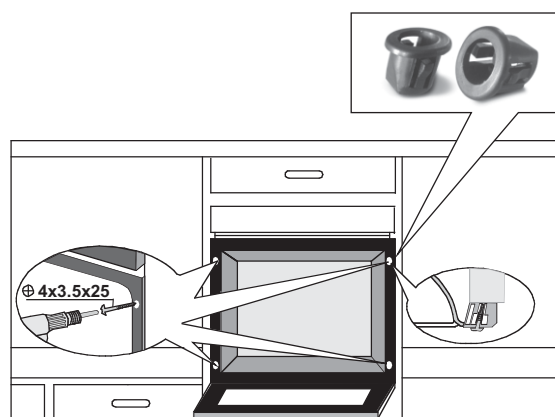
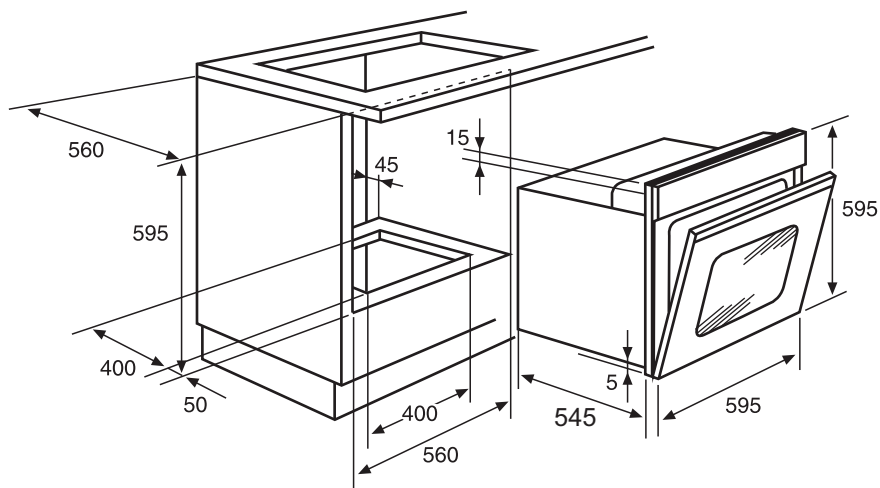

Protection trim (supplied with the oven when necessary)
 Защитно уплътнение (доставя се с фурната ако е необходимо)

- IT** Targhetta matricola
- GB** Rating plate
- ES** Tarjeta matricula
- NL** Typeplaatje
- DE** Typenschild
- FR** Plaque signalitique
- PT** Placa de características
- PL** Tabliczka znamionowa
- CZ** Typový štítek
- SI** Tablica s podatki
- БГ** Указателна табела



IT

La Ditta costruttrice declina ogni responsabilità per eventuali errori di stampa contenuti nel presente libretto. Si riserva inoltre il diritto di apportare le modifiche che si renderanno utili ai propri prodotti senza compromettere le caratteristiche essenziali.

GB

The manufacturer will not be responsible for any inaccuracy resulting from printing or transcript errors contained in this brochure. We reserve the right to carry out modifications to products as required, including the interests of consumption, without prejudice to the characteristics relating to safety or function.

ES

La empresa constructora declina toda responsabilidad derivada de eventuales errores de impresión contenidos en el presente libro. Se reserva además el derecho de realizar las modificaciones que se consideren útiles a los productos sin comprometer las características esenciales.

NL

De fabrikant stelt zich niet aansprakelijk voor eventuele drukfouten in deze brochure. Kleine veranderingen en technische ontwikkelingen zijn voorbehouden.

DE

Der Hersteller übernimmt keine Haftung für eventuelle Druck- oder Übersetzungsfehler dieser Bedienungsanleitung. Der Hersteller behält sich vor, technische Änderungen zur Verbesserung der Produktqualität im Interesse des Endverbrauchers vorzunehmen.

FR

Le constructeur décline toute responsabilité concernant d'éventuelles Inexactitudes Imputables à des erreurs d'impression ou de transcription contenue dans cette notice. Le constructeur se réserve le droit de modifier les produits en cas de nécessité, même dans l'intérêt de l'utilisation, sans causer de préjudices aux caractéristiques de fonctionnement de sécurité des appareils.

PT

O fabricante declina toda e qualquer responsabilidade por gralhas, erros tipográficos ou de transcrição/tradução contidos neste manual. Reservamo-nos o direito de Introduzir alterações nos nossos produtos, conforme necessário, tendo inclusive em atenção os Interesses relativos ao respectivo consumo, sem prejuízo das características associadas à segurança ou ao funcionamento dos electrodomésticos.

PL

Producent nie ponosi Żadnej odpowiedzialności za ewentualne błędy w druku niniejszej instrukcji. Ponadto zastrzega sobie prawo do wprowadzania zmian do własnych produktów, uznanych przez niego za użyteczne, bez pogarszania podstawowych parametrów.

CZ

Výrobce nezodpovídá za nepřesnosti obsažené v této příručce vzniklé při tisku nebo překladu. Vyhradzujeme se právo provádět úpravy výrobku podle potřeby, aniž by byly dotčeny charakteristiky vztahující se k bezpečnosti nebo provozu.

SI

The manufacturer will not be responsible for any inaccuracy resulting from printing or transcript errors contained in this brochure. We reserve the right to carry out modifications to products as required, including the interests of consumption, without prejudice to the characteristics relating to safety or function.

БГ

Производителя не носи отговорност за неточности и грешки възникнали при печата на тази инструкция. Производителя си запазва правото да внесе изменения в своите продукти, който смята за полезни, без това да е в ущърб на характеристиките свързани със сигурността или основните функции на уреда .