

..... **OWNER'S MANUAL**

Model AC115

..... Baby Sound and Movement Monitor



Cord Safety

Ensure the Nursery Unit is at least 1 metre away from your baby's cot. The Sensor Pad cord must always be kept out of reach of baby and secured using the cord cover kit provided.

..... For assistance, FAQs or guidance with your monitor
..... please visit our Customer Support page at angelcare.co.uk

TABLE OF CONTENTS
.....

 WARNINGS.....	2
SETUP REQUIREMENTS.....	3
Charging the Parent Unit (10 hours).....	4
Positioning the movement Sensor Pad.....	5
Setting up the Nursery Unit.....	8
Turning on your monitor.....	9
Testing and getting to know your monitor.....	11
Activating and deactivating additional functions.....	17
Troubleshooting.....	18
Limited warranty.....	21
Technical specifications.....	21

OWNER'S MANUAL

KEEP YOUR OWNER'S MANUAL FOR FUTURE REFERENCE.

PLEASE READ THE WARNINGS AND INSTRUCTIONS CAREFULLY BEFORE ASSEMBLING & USING THE PRODUCT.

FAILURE TO FOLLOW THE WARNINGS AND THE INSTRUCTIONS COULD RESULT IN SERIOUS INJURY OR DEATH OR DAMAGES TO THE PRODUCT.

THE SENSOR PAD FEATURE IS NOT FOR USE WITH ADULTS, CHILDREN OR INFANTS OLDER THAN 24 MONTHS.

THE SENSOR PAD IS NOT INTENDED TO BE USED TO DETERMINE IF A CHILD IS OUT OF THE COT.

WARNING

Adult assembly required.

Keep small parts away from children when assembling.

We, at Angelcare®, stand behind all of our products.

If you are not completely satisfied or have any questions,

United States and Canada: Please contact us at: angelcare@cdcinc.ca

Other countries: Please contact your local distributor.

WARNINGS

1. THIS PRODUCT CANNOT REPLACE RESPONSIBLE ADULT SUPERVISION. This product is designed to aid in the monitoring of your baby. When using the monitor, you must still provide the supervision necessary for the continued safety of your baby. Monitoring of premature babies, or those considered to be at risk, should always be carried out under the supervision of a health professional. This monitor SHOULD NOT be used as a medical device, nor as a device to prevent Sudden Infant Death Syndrome (SIDS).

2. **WARNING Strangulation Hazard** – Children have STRANGLED in cords. Keep adapter cords out of the reach of children (more than 1 meter away). NEVER use Wired Sensor Pad(s) without the protective cord covering. Check protective cord covering before each use. Immediately discontinue use of Wired Sensor Pad(s) if protective covering is damaged or broken.

3. Never use extension cords with AC adapters. ONLY use the AC adapters provided.

4. When an AC Adapter is plugged into an electrical outlet, DO NOT touch the exposed end.

5. ALWAYS be sure that both the transmitter and receiver are working properly and are within range of each other. Test monitor before first use, periodically and when changing location of the Nursery Unit.

6. ALWAYS be sure to immediately check on baby whenever an alarm sounds.

7. DO NOT use monitor near water (such as bath tub, sink, etc.).



8. Keep monitor AWAY from heat sources (such as stoves, radiators, etc.).

9. ALWAYS place both the Nursery Unit and Parent Unit on a flat surface in an upright position and allow for proper ventilation. DO NOT place on sofas, cushions, beds, etc. which may block ventilation.

10. This monitor uses public airwaves to transmit signals. The Parent Unit may pick up signals or interference from other nursery monitors in your area. Your monitor may even be picked up by other households. To protect your privacy, make sure both units are turned OFF when not in use. If you experience interference, change the channel on both units.

11. This product is NOT a toy. DO NOT allow children to play with it.

12. This product contains small parts. Adult assembly required. Exercise care when unpacking and assembling the product and keep small parts away from children.

13. Use and store the monitor at a temperature between 10 °C and 40 °C.

BATTERY WARNING

14. Use ONLY AAA RECHARGEABLE batteries for the Parent Unit. DO NOT mix old and new batteries. DO NOT mix alkaline, standard or rechargeable batteries. Insert batteries with correct polarity. DO NOT short-circuit supply terminals. ONLY use the recommended batteries or equivalent (volts and size) and the correct adapter. Remove batteries when product is stored for long periods of time or when batteries are exhausted. Dispose exhausted batteries properly. DO NOT recharge non-rechargeable batteries. Rechargeable batteries are ONLY to be charged under adult supervision. Keep all batteries away from children.

15. IMPORTANT SAFETY INSTRUCTIONS

15.1 Read these instructions - All the safety instructions should be read before the product is operated.

15.2 Keep these instructions. The safety and operating instructions should be retained for future reference.

15.3 Heed all warnings - All warnings on the product and in the operating instructions should be adhered to.

15.4 Follow all instructions - All operating and use instructions should be followed.

15.5 Water and moisture - DO NOT use this apparatus near water. For example, near a bath tub, wash bowl, kitchen sink, laundry tub, in a wet environment or near a swimming pool and the like. Care should be taken so that objects DO NOT fall onto units and that liquids are not spilled into either unit or Sensor Pad through its openings.

15.6 Cleaning - Disconnect all units before cleaning. DO NOT immerse in water any part of the Nursery Unit, Parent Unit. Clean only with dry cloth.

15.7 Ventilation - DO NOT block any ventilation openings. Allow for proper ventilation when units are in use. DO NOT cover the Nursery Unit or Parent Unit with any object such as a blanket. DO NOT place it in a drawer or in any location which would muffle the sound or interfere with the normal flow of air.

15.8 Heat sources - DO NOT install near any heat sources such as radiators, heat registers, stoves, TVs or other apparatus (including amplifiers) that produce heat. Heat can damage the case or electrical parts.

15.9 Power cord protection - Protect the Sensor Pad cord and Adapter's power cord from being walked on or pinched by furniture or other items - Power supply cords should be routed so that they are not likely to be walked on or pinched by items upon or against them, paying particular attention to cords and plugs, convenience receptacle, and the point where they exit from the product.

15.10 Accessories - Only use attachments/accessories specified by the manufacturer. DO NOT place this product on an unstable cart, stand, tripod, bracket or table. The product may fall, causing serious injury to a child or adult and serious damage to the product. Use ONLY with a cart, stand, tripod, bracket or table recommended by the manufacturer or sold with the product. Any mounting of the product should follow the manufacturer's instructions.

15.11 Unplug this appliance during lightning storms or when not used for long periods of time.

15.12 Servicing - DO NOT attempt to service this product yourself as opening or removing covers (except battery doors) may expose you to dangerous voltage or other hazards.

15.13 Replacement parts - When replacement parts are required, be sure the replacement parts specified by the manufacturer have the same characteristic as the original part. Unauthorized substitution may result in fire, electric shock or other hazards.

15.14 Usage - This baby monitor is intended as an aid. It is NOT a substitute for responsible and proper adult supervision and should not be used as such. Use this appliance ONLY for its intended use as described in this manual.

15.15 Power Sources - Operate this product only from the type of power source indicated on the type plate of the adaptor. If you are unsure of the type of power supply to your home, consult your dealer or local power company.

15.16 Overloading - DO NOT overload wall outlets, extension cords or integral convenience receptacles as this can result in a risk of fire or electric shock.

15.17 Object and Liquid Entry - NEVER push objects of any kind into this product through casing slots as they may touch dangerous voltage points or short out parts that could result in a risk of fire or electric shock. NEVER spill liquid of any kind on the product.

15.18 Antenna - The antenna used for this transmitter must be installed to provide a separation distance of at least 20 cm from all persons and must not be collocated or operating in conjunction with any other antenna or transmitter.

15.19 Power Lines - An outside antenna system should NOT be located in the vicinity of overhead power lines or other electric light or power circuit, or where it can fall into such power lines or circuits as contact with them may be fatal.

15.20 WARNING Strangulation Hazard — Children have STRANGLED in cords. Keep adapter cords out of the reach of children (more than 1 meter away). NEVER use Sensor Pad(s) without the protective cord covering. Check protective cord covering before each use. Immediately discontinue use of Sensor Pad(s) if protective covering is damaged or broken.

15.21 Interference - This monitor uses public airwaves to transmit signals. The Parent Unit may pick up signals or interference from other nursery monitors in your area. Your monitor may even be picked up by other households. To protect your privacy, make sure both units are turned OFF when not in use. If you experience interference, change the channel on both units.

15.22 Vibration Source - When the monitor is in use, DO NOT use a bedside crib, cot mobile or other cot accessories that may produce vibrations. Other sources of vibrations may include fans, washing machines, loud music, etc. These sources of vibration may interfere with the performance of your Angelcare® monitor and the alarm will not sound if it continues to detect any movement other than your baby's. Be sure all vibration sources are eliminated before using the monitor.

15.23 You may experience false alarms for several reasons. The most common reason is the Nursery Unit has not been turned OFF after you have removed your baby from the cot. Another reason is the Sensor Pad has not been placed under the mattress properly.

Be sure the Sensor Pad is on a flat, firm surface with the printed side facing up. The sensitivity level may also need to be adjusted. Refer to **Step 5.4**. Always be sure to immediately check on baby whenever an alarm sounds.

15.24 Sensor Pad - If the cot has a spring or slat base, place a hard board between the cot base and the Sensor Pad measuring at least 33 x 33 cm and 6 mm thick. Only use your Angelcare® monitor in a stationary sleeping environment such as a cot where the Sensor Pad can rest on a completely flat, firm surface. The Sensor Pad is made of plastic and does not permit the air to circulate. Therefore, mildew build up could develop underneath the mattress in the Sensor Pad area. We suggest rotating the mattress regularly to prevent any mildew.

16. IMPORTANT SAFETY INSTRUCTIONS RELATED TO USE OF BATTERIES

16.1 Use ONLY the type and size of batteries specified in the owner's manual. There is a risk of explosion if batteries are replaced with an incorrect type.

16.2 Use ONLY AAA rechargeable batteries and/or the AC Adapters provided for the Parent Unit. You must use only rechargeable batteries in the Parent Unit. DO NOT use alkaline batteries or you will severely damage the unit.

16.3 Charge the batteries for 10 hours prior to first use. Be sure to have the monitor in the OFF position during this period. ONLY use the AC Adapters included with your monitor.

16.4 DO NOT use these adapters with any other equipment.

16.5 When unplugging the AC Adapter from the Nursery Unit, be sure it is switched to the OFF position. If it isn't, the unit will revert to battery mode if batteries are installed.

16.6 DO NOT use rechargeable batteries in the Nursery Unit. Use alkaline batteries ONLY.

16.7 DO NOT dispose batteries in fire. They may explode. Check with local regulations for possible special disposal instructions.

16.8 Exercise care in handling batteries in order not to short out the batteries with conducting materials such as rings, bracelets and keys. Overcharging, short circuiting, reverse charging, mutilation, or incineration of batteries must be avoided to prevent one or more of the following occurrences: release of toxic materials, release of hydrogen and/or oxygen gas and rise in surface temperature.

16.9 DO NOT attempt to recharge batteries provided with or identified for use with this product that are not intended to be charged. The batteries may leak corrosive electrolyte or explode.

16.10 DO NOT attempt to rejuvenate the batteries provided with or identified for use with this product by heating them. Sudden release of battery electrolyte may occur, causing burns or irritation to eyes or skin.

16.11 If and when necessary, the batteries must be replaced with identical new ones or equivalent (volts and size). If a battery to be replaced is connected with other batteries in series, replace the other batteries at the same time as well. DO NOT mix old and new batteries.

16.12 Reverse polarity installation of the batteries in the end product must be avoided. Reverse insertion of batteries can cause charging, and that may result in leakage or explosion.

16.13 Remove batteries from this product if you store the product over 30 days because the batteries could leak and damage the product.

16.14 Discard 'dead' batteries as soon as possible since 'dead' batteries are more likely to leak in a product. If a battery has leaked or vented, it should be replaced immediately using protective gloves.

16.15 DO NOT store this product, or the batteries provided with or identified for use with this product, in high-temperature areas.

SETUP REQUIREMENTS

INCLUDED:

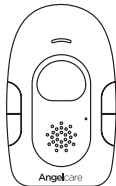

Parent Unit

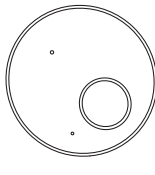

Nursery Unit



Tabletop stand (for Nursery Unit)



6 Pre-threaded cord covers with Split USB cable



Wired Movement Sensor Pad
* Always place Angelcare® logo side up *

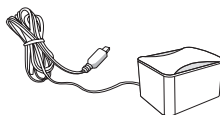

AC adapter (for Parent Unit)

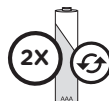

2 Rechargeable AAA Batteries (for Parent Unit)



AC adapter (for Nursery Unit)

Model AC115

Sound and Movement Monitor

YOU MUST PREPARE:

One hardboard (not included)
Thickness: **6 mm**
Minimum dimensions:
33 x 33 cm
Maximum dimensions:
equal to the mattress size

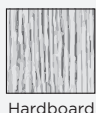

IMPORTANT

The hardboard must be larger than the Sensor Pad surface.

WHAT YOU WILL NEED (NOT INCLUDED):



2 AAA Alkaline
Batteries
(for Nursery Unit)



Miniature Philips
Screwdriver

STEP 1 - CHARGING THE PARENT UNIT (10 HOURS)

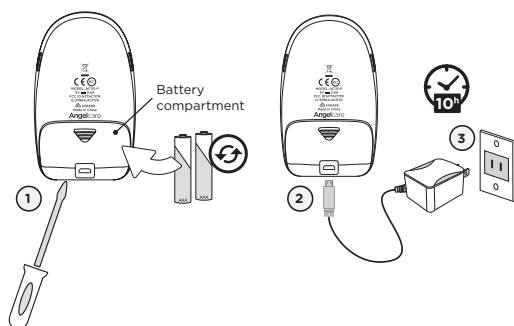

- 1) Remove the battery compartment on the rear. Insert the provided rechargeable batteries into the compartment.
- 2) Connect the USB plug to the Parent Unit.
- 3) Connect the power adapter to an electrical outlet.
- 4) Charge the unit for **10 continuous hours prior to first use.**

PARENT UNIT:

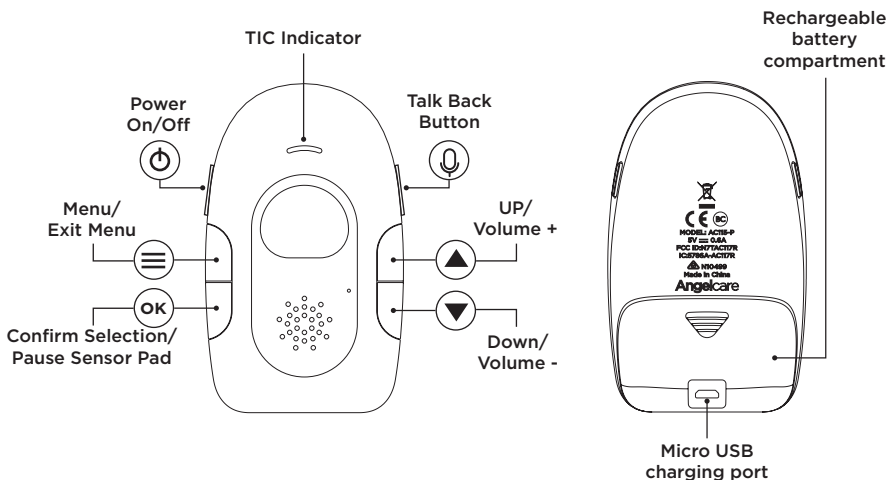



⚠ WARNING

STRANGULATION HAZARD.

Children have STRANGLED in cords:

- Keep adapter cords out of the reach of children (more than 1 meter away).
- Because of the serious strangulation risk to infants and toddlers, parents and caregivers should never place the Nursery Unit within 1 meter of a cot.
- **NEVER** use Sensor Pad without the cord covers. Check cord covers before each use to ensure it is securely placed under the leg of the cot. Discontinue use of Sensor Pad if any cord covers are damaged or broken.
- **NEVER** use extension cords with adapters. **ONLY** use the adapters provided. This product is not a toy. Never allow children to play with it.

STEP 2 - POSITIONING THE MOVEMENT SENSOR PAD

2.1 - SELECT A LOCATION FOR THE NURSERY UNIT

IMPORTANT

Place the cot near a supporting wall and far from air currents. Install the Nursery Unit on a flat, stable surface facing the cot at a distance of at least **1 meter**. Make sure to plug the adapter to the socket outlet nearest to the equipment and that is easily accessible.

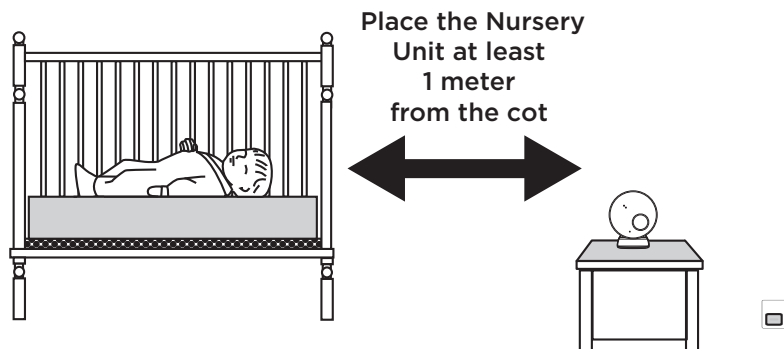

1) Insert **jack 1** into the Sensor Pad and twist it clockwise to lock it.

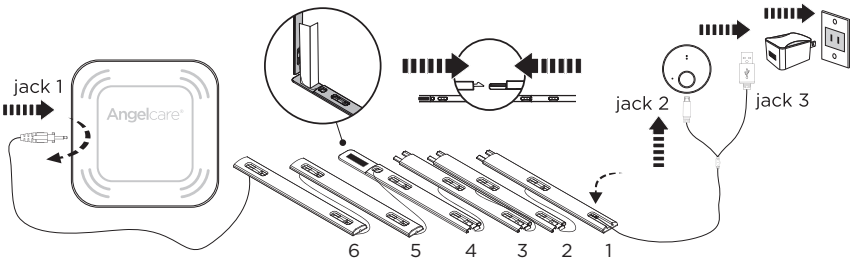

2.2 - SELECT THE COT LEG TO SECURE THE CORD COVERS

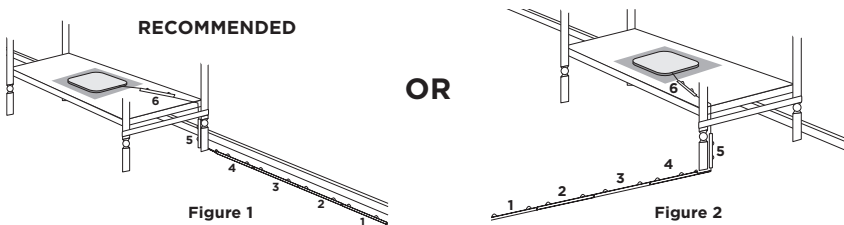

Use the cot leg by the wall closest to the Nursery Unit (**Figure 1**). In cases where the Nursery Unit is across the room, use the leg closest to the Nursery Unit to position the covered wire (**Figure 2**). It is always preferable that the covered cord run along a wall.

2.3 - INSTALL THE SENSOR PAD ON THE MATTRESS SUPPORT

IMPORTANT

If your cot does not have a solid, stable surface for the Sensor Pad, you will need to place a support under it, to ensure correct operation of the system.

This hardboard support should be at least 6 mm thick and should have minimum dimensions of 33 x 33 cm. This support board must be larger than the Sensor Pad surface area.



Hardboard

The Sensor Pad functions with any size and type of mattress except memory-foam mattresses, hollow frame mattresses and water beds. The hardboard maintains a constant pressure on the Sensor Pad, enabling it to detect baby's movements even when baby is at the edge of the cot.

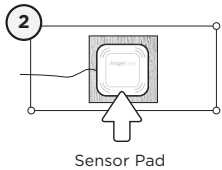

Sensor Pad

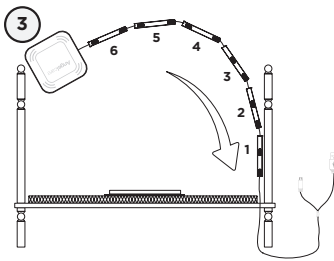

- 1) Remove the mattress from the cot.
- 2) Place the Sensor Pad – **Angelcare® logo side up** – on top of the hardboard.
- 3) Run the connection pin, warning label and the first 5 cord covers down along the rear of the cot leg, **between the mattress support and the inside edge of the cot.**

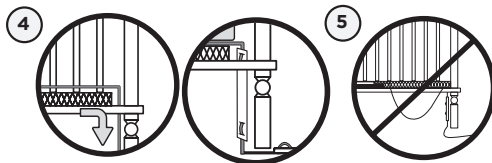

- 4) Bring the first 4 cord covers down the floor, and keep the 5th cord cover vertically, along the rear of the cot leg, **between the mattress and the inside edge of the cot.**

- 5) Remove any cord slack to make sure no parts of the cord are loose.

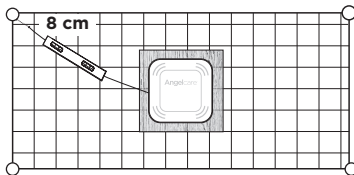

- 6) Place the 6th cord cover approximately **8 cm** from the edge of the mattress support.

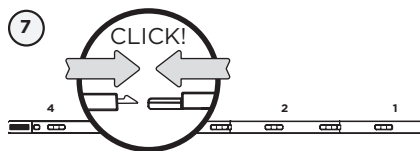

- 7) Snap together the remaining cord covers that will run along the floor.

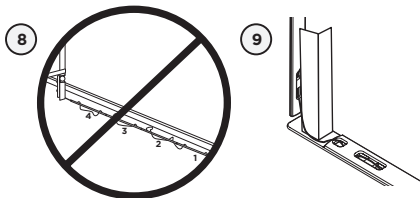

- 8) Remove any cord slack to make sure no parts of the cord are loose.
- 9) Peel off the double-sided tape on the 4th cord cover and place it securely under the cot leg.

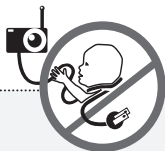

! WARNING

STRANGULATION HAZARD

- Remove all slack from Sensor Pad Cord.
 - When lowering the mattress support as your baby grows, slide the vertical Cord Cover downward so it remains approximately in the center between the mattress support and the floor. Slide the Sensor Pad Cord through the Floor Cover to eliminate any additional slack.
- The Sensor Pad is not designed for use with adults, children or infants older than 24 months.
 - Discontinue use of the Sensor Pad when baby is older than 24 months. Deactivate the Movement Function and remove the Sensor Pad from cot and store for future use.
 - **BEFORE FIRST TIME USE:** To test that the unit is ready for use, refer to instruction manual on how to test that the installation has been done correctly.

STEP 3 - SETTING UP THE NURSERY UNIT

Select a location for the Nursery Unit that is at least **1 meter** away from the cot.

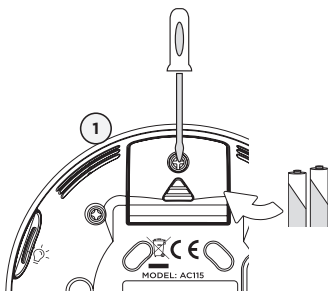

- 1)** Remove the batteries cover and insert 2 AAA Alkaline Batteries (not included)

Note:

The batteries are a back up power supply in case of power outage.

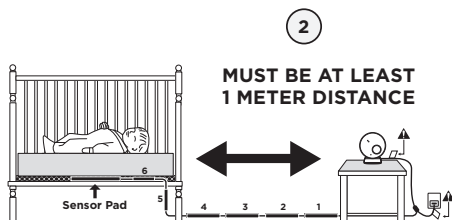

- 2)** Install the Nursery Unit on a flat, stable surface facing the cot at a distance of at least **1 meter** and plug the Sensor Pad cord into the Nursery Unit.
- 3)** Check to make sure the Sensor Pad has not moved from its position.
- 4)** Place the mattress back inside the cot.

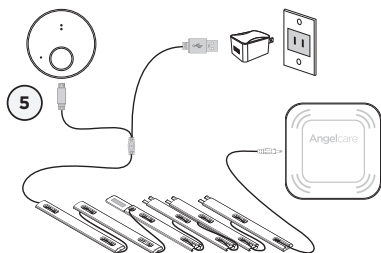

- 5)** Connect the USB plug to the Nursery Unit and the USB plug with the power adapter and then to an electrical outlet.

Note: Each time you power **ON** your Nursery Unit, the internal thermometer will need to calibrate to ensure accuracy. This automatic process will take approximately 30 minutes. The colour changing temperature display, by default, will be turned “**OFF**”. You may turn this feature “**ON**” in the settings mode on your Parent Unit.

NURSERY UNIT:

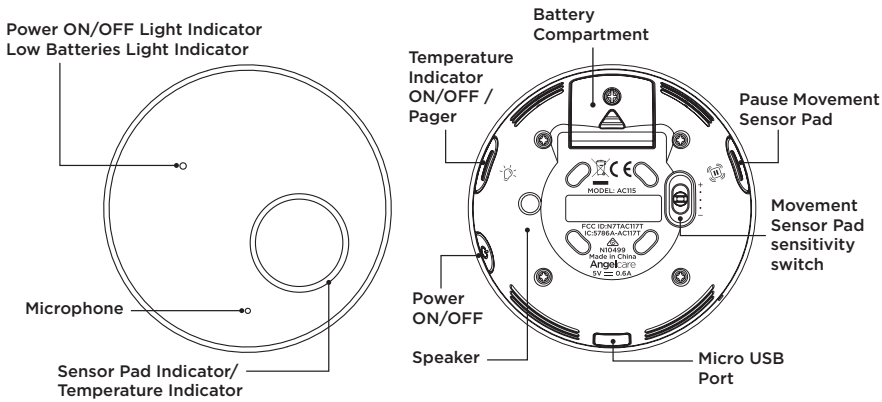









STEP 4 - TURNING ON YOUR MONITOR

YOU ARE NOW READY TO USE YOUR MONITOR

The Angelcare® monitor can be used with the pre-program factory settings or you can also customize your settings to your preference.

DEFAULT SETTINGS

	Detection Mode:	
	Movement:	ON
	Sound:	ON
	Sound transmission (VOX):	OFF
	TIC Function:	OFF
	VOX Sensitivity:	Level 2 (of 4)
	Temperature Unit:	Celsius
	Temperature Alarm:	OFF
	Temperature Alarm Setting:	High: 30 °C Low: 19 °C

TURN ON YOUR MONITOR

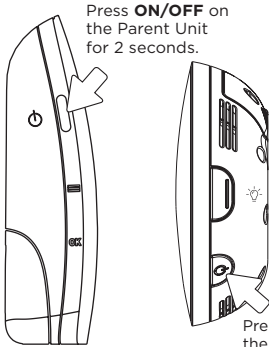

NOTE:

The screen of the Parent Unit flashes the out-of-range icon until it displays the room temperature and function icons. The connection process should be complete within 30 seconds. If this sequence is not completed within 30 seconds you will need to switch the units off and repeat.

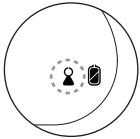

When the Parent Unit is **ON** and Nursery Unit is **OFF** or, if there is a lost connection between the 2 units;

- The **Out-of-Range** icon on the Parent Unit will blink
- The Parent Unit will beep 3 times every 15 seconds

IMPORTANT ICONS

Temperature alerts icons:

Too Warm

Too Cold

Detection mode icons:

Indicates which functions are activated

Movement only →

Sound only →

Movement, Sound & "TIC" →

Movement & Sound →

Movement & "TIC" →

VOX icon: Indicates when the Nursery Unit is in VOX mode

Sound activated transmission (VOX ON) →

Continuous sound transmission (VOX OFF) →

Temperature display

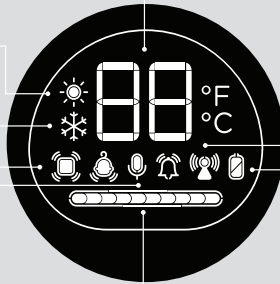

Sound Sensitivity Indicator

Connection icon: Indicates the connection quality between the Parent Unit and the Nursery Unit

← Good connection

← Medium connection

← Poor connection

← Out-of-range

Battery level icon: Indicates Parent Unit battery life

← Full

← 1/2

← Empty

← Charging

STEP 5 - TESTING AND GETTING TO KNOW YOUR MONITOR

The Angelcare® monitor can be used with the pre-programmed factory settings or you can customize your settings to your preference.



All changes and adjustments made in the main menu will not be saved unless you confirm them by pressing the **EXIT** button.

IMPORTANT

When in MENU mode, sound transmission between the Parent and Nursery Units will be temporarily deactivated. The TIC indicator will flash rapidly if no movement is detected.

5.1 - MENU ACCESS AND CHANGING THE SETTINGS

The MENU settings are accessed by pressing and HOLDING the MENU button on the Parent Unit. The MENU functions are in a loop. Each time you press the **OK** button briefly you move on to the next setting. Once you have selected your preferred settings you must press **EXIT MENU** or your changes will not be saved. The MENU functions are in the following order:

PRESS AND HOLD: Movement & "TIC"	STEP 5.2
PRESS 1 TIME: Sound	STEP 5.5
PRESS 2 TIMES: Sound Transmission (VOX)	STEP 5.6
PRESS 4 TIMES: Temperature	STEP 5.7

5.2 - ACTIVATING/DEACTIVATING THE SENSOR PAD

SET THE MOVEMENT DETECTION

Allows you to detect baby's movements.

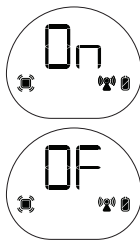
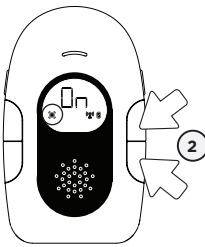

- 1) Press and **HOLD** the **MENU** button until the **Movement monitoring** icon blinks.
- 2) Use the **UP** and **DOWN** arrows to activate or deactivate movement detection.
- 3) Press the **OK** button to go to the next setting or press the **EXIT** button to confirm your choice.

SET THE TIC FUNCTION

Allows you to detect baby's movements as well as hear a TIC sound.

IMPORTANT

To activate the "TIC" Function, the movement detection activated.

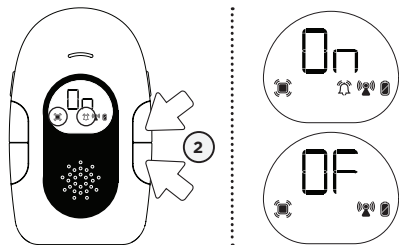

- 1) Press and **HOLD** the **MENU** Button then press the **OK** button until the "TIC"  icon blinks.
- 2) Use the **UP** and **DOWN** arrows to activate or deactivate the TIC function.
- 3) Press the **OK** button to go to the next setting or press the **EXIT** button to confirm your choice.

TO TEST THE SENSOR PAD

MOVEMENT FUNCTION NEEDS TO BE ACTIVATED:

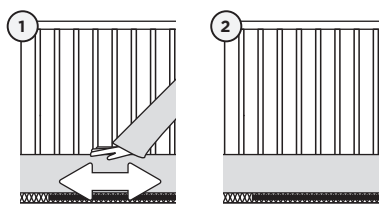

- 1) Move your hand lightly on the mattress.

NOTE:

The Parent Unit will emit a "TIC" sound (when activated) and will flash every 5 seconds.

- 2) Remove your hand from the mattress. After 15 seconds you will hear a "TIC" pre-alarm sound, and 5 seconds later the Movement Alarm will trigger.
- 3) Repeat by moving your hand lightly in all four corners of the mattress.

MOVEMENT ALARM

- If NO movement is detected after 15 seconds you will hear a single "TIC" pre-alarm sound from the Nursery Unit.
- If after a further 5 seconds there is still NO movement detected on the surface of the mattress, the Parent Unit and Nursery Unit will emit loud continuous beeps - this is the Movement Alarm.
- Nursery Unit light will flash red.
- Sensor Pad Icon and sound level bar on Parent Unit will flash.



IF THE ALARM DOES NOT SOUND

- Avoid contact with cot while Sensor Pad is in operation.
- Place cot near a supporting wall.
- Adjust Sensor Pad sensitivity level.
- Turn OFF cot mobile, fans, loud music or anything else that may cause vibration.

TO STOP THE ALARM

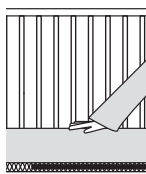

Place your hand back on the mattress.

OR

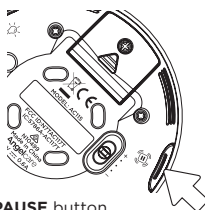

Press **PAUSE** button on the Nursery Unit

OR

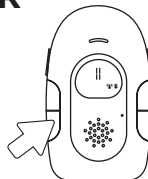

Press any button on the Parent Unit.

5.3 - PAUSING AND RESTARTING THE SENSOR PAD

Allows you to pause the Sensor Pad if you remove baby from the cot, e.g. for feeding or comforting.

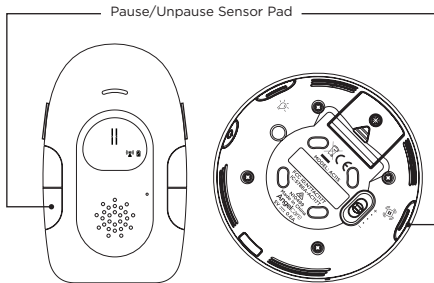

- 1) From the Parent Unit, press and hold **Pause Sensor Pad** button for at least 2 seconds.

OR

From the Nursery Unit, press the **Pause** button.

- 2) To unpause the Sensor Pad, from the Parent Unit, press the **Pause Sensor Pad** button (OK button)

OR

From the Nursery Unit, press the **Pause** button.

IMPORTANT

- If you do not pause the Sensor Pad, the alarm will sound if there is no movement detected on the surface of the mattress after 20 seconds.
- Ensure to unpause the Sensor Pad before putting back in the cot.

5.4 - ADJUST THE SENSOR PAD SENSITIVITY LEVEL:

To ensure adequate monitoring of your baby's movements, you can adjust the sensitivity of the Sensor Pad. Set a high sensitivity for a newborn and a lower sensitivity as baby grows and gains weight. A thicker mattress will also need a higher sensitivity. Slide the Nursery Unit sensitivity level button to select between low, medium or high level.

For optimal results begin with medium sensitivity level, adjusting the sensitivity by increasing or decreasing if required.

NOTE:

If you are experiencing false alarms, adjust the sensitivity level.

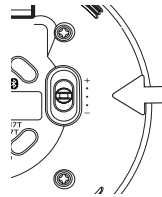



IMPORTANT

- The Sensor Pad is not designed for use with adults, children or infants older than 24 months.
- Once you are finished using the Sensor Pad, please deactivate the movement function, remove it from the baby's cot and store it away.

5.5 - SOUND

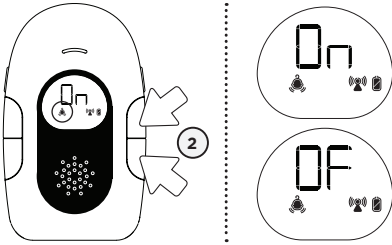
TO ACTIVATE SOUND:



- 1) Press and hold the **MENU** Button then press the **OK** button until the **Sound Monitoring**  icon blinks.
- 2) Using the **UP** and **DOWN** arrows to turn the function **ON** or **OFF**.
- 3) Press the **OK** button to go to the next setting or press the **EXIT** button to confirm your choice.

TO TEST SOUND:

Ask someone to speak into the Nursery Unit or place the unit near a radio to ensure that sound is being picked up.

IMPORTANT

To avoid feedback (whistling), keep both units at least 3 meters apart.

IF YOU HEAR NO SOUND:

- Check that both units are powered **ON**.
- Check that both units are plugged into functioning electrical outlets.
- Check the batteries in both units (replace or recharge them if necessary).
- Bring the Parent Unit closer to the Nursery Unit.

ADJUST THE SOUND LEVEL

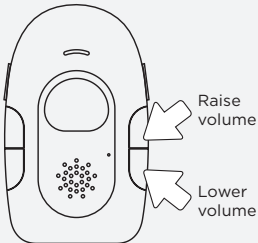

PUT IN MUTE MODE

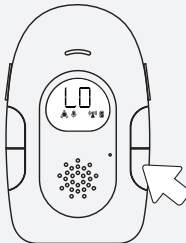

Press the **VOLUME** - until **LO** is being displayed. When in **MUTE** the sound icon will flash to indicate this.

PUT IN DIALOGUE MODE

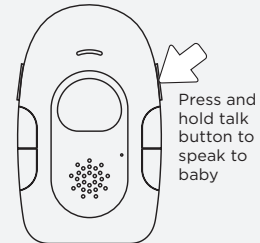

5.6 - VOICE ACTIVATION (VOX ON) OR CONTINUOUS SOUND (VOX OFF) MODE

Allows you to select your option on how you monitor sound: **VOX** (voice activation picks up sound based on the setting of the sensitivity level) or **Continuous** (sound monitoring is continuously on, picking up all sounds).

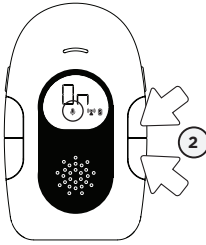

- 1) Press and hold the **MENU** button then press the **OK** button until the **VOX**  icon blinks.
- 2) Use the **UP** and **DOWN** arrows to activate or deactivate the VOX function.
- 3) Press the **OK** button to go to the next setting or press the **EXIT** button to confirm your choice.

TO ADJUST SOUND SENSITIVITY (VOX)

The sensitivity of the microphone is adjustable and has 4 levels (the most sensitive is level 4). This means that sound will only transmit based on the level that you set.

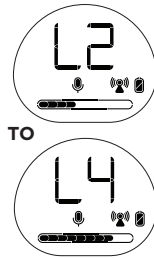
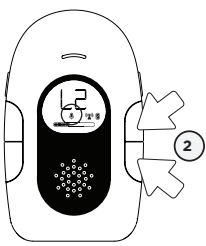

- 1) When the Sound Transmission is **ON** (VOX ON) press and hold the **MENU** button then press **OK** button until **VOX ON**  icon blinks.
- 2) Use the **UP** and **DOWN** arrows to select desired microphone sensitivity level.
- 3) Press the **OK** button to go to the next setting or press the **EXIT** button to confirm your choice.

5.7 - TEMPERATURE

TO SELECT TEMPERATURE IN CELSIUS OR FAHRENHEIT

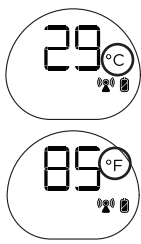
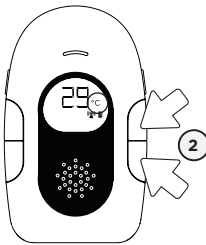

- 1) Press and hold the **MENU** button then press **OK** button until the **°C / °F** icon blinks.
- 2) Use the **UP** and **DOWN** arrows to select temperature in Celsius or Fahrenheit.
- 3) Press the **OK** button to go to the next setting or press the **EXIT** button to confirm your choice.

TO ACTIVATE THE TEMPERATURE ALARM

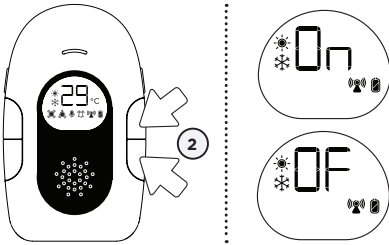

- 1) Press and hold the **MENU** button then press **OK** button until the **Temperature Indicator** ❄️🔥 icon blinks.
- 2) Use the **UP** and **DOWN** arrows to activate or deactivate the temperature alarm.
- 3) Press **OK** button to confirm your choice and set the Temperature range as below.

TO SET TEMPERATURE RANGE

NOTE:

Make sure to turn **ON** Temperature alarm to be able to set Temperature range.

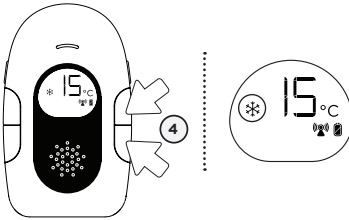

- 4) The **Low Temperature** ❄️ icon will blink. Use the **UP** and **DOWN** arrows to set the **LOW** temperature alarm (5 to 19° Celsius).
- 5) Press the **OK** button to confirm your choice.

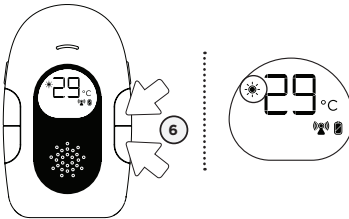

- 6) The **High Temperature** 🔥 icon will blink. Use the **UP** and **DOWN** arrows to set the **HIGH** temperature alarm (22 to 37° Celsius).
- 7) Press the **OK** button to go to the next setting or press the **EXIT** button to confirm your choice.

The low temperature range is 5 to 19°C and high temperature range is 22 to 37°C.

TEMPERATURE ALARM

- Alarm activates when the temperature reaches the maximum or minimum set temperature.
- Parent Unit will emit 3 consecutive beeps, every 5 seconds if the temperature reaches levels out of your chosen range. The relevant icon will flash on the Parent Unit screen to alert you.

STEP 6 - ACTIVATING AND DEACTIVATING ADDITIONAL FUNCTIONS

6.1 - ACTIVATE OR DEACTIVATE TEMPERATURE INDICATOR ON NURSERY UNIT

With this option the Nursery Unit Temperature Indicator will light up in colour when the temperature goes above or below your preferences. If the temperature goes above your set preferences and this option is turned ON, the light on the Nursery Unit will turn to red instead of the default white. If the temperature goes below the set preferences, then the light will turn blue.

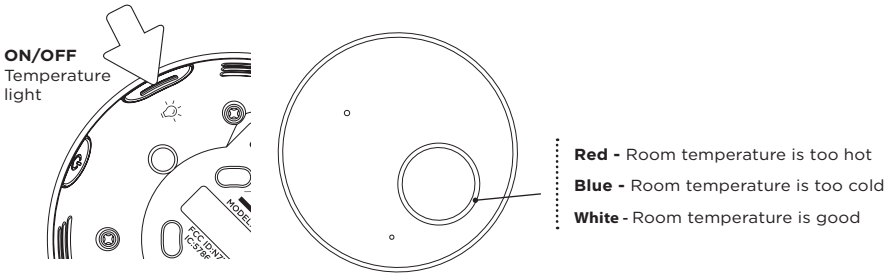

6.2 - OUT OF RANGE SETTINGS

Your monitor has an Out-of-Range alarm that advises you when your two units are not communicating. Out-of-Range situations can be caused by distance or by physical interferences.

RANGE:

Open field (Open area without obstructions): up to 230 meters.

OUT-OF-RANGE ALARM

- Alarm activates when your two units are not communicating.
- The Parent Unit will emit a triple beep every 16 seconds.
- Out-of-Range Icon will flash on the screen.



IMPORTANT

If you turn the Nursery Unit OFF the Out-of-Range Alarm will sound. Turn the Nursery Unit ON again to reactivate the link.

TO STOP THE OUT-OF-RANGE ALARM:

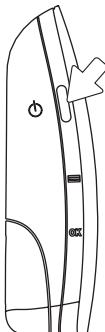

Press 2 seconds
to turn the Parent
Unit **OFF**

OR



Turn the Nursery
Unit **ON**

6.3 - PAGER

Allows you to locate the Parent Unit.

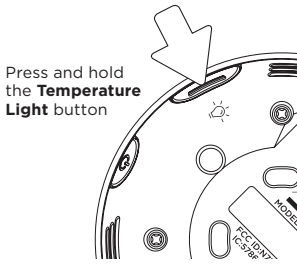

TO LOCATE THE PARENT UNIT

Press and hold the Temperature Light button on the side of the Nursery Unit. The Parent Unit will emit a paging sound.

TO STOP THE PAGING SOUND

Press any button on the Parent Unit or the Pager button on the Nursery Unit.

TROUBLESHOOTING

TAKING CARE OF YOUR RECHARGEABLE BATTERIES

- Ensure that you fully charge your batteries for 10 hours before their first use.
- To maintain maximum battery life it is recommended that you fully discharge your batteries periodically. Battery performance can be diminished by leaving the batteries constantly charging. If your Parent Unit is not in use, please turn it off.
- Inadequate battery power can impair the performance of your monitor. If you are not happy with the performance of your Parent Unit please replace the rechargeable batteries (2 x NiMH Rechargeable Batteries).
- It is advisable to change the batteries every 6 months.

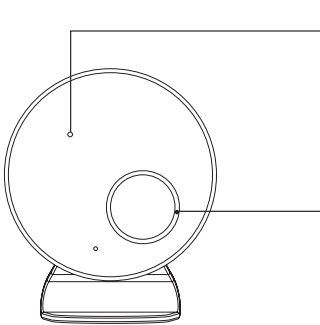

Power On/Off Light Indicator Low Battery Light Indicator	
Flashing green	Nursery unit is using the back-up batteries
Flashing yellow	Nursery Unit batteries are low
Steady green	Monitor is activated

Sensor Pad Light Indicator Temperature Indicator	
Flashing red	No movement is detected or Sensor Pad is disconnected
Flashing white	Monitor is paused
Steady Red	Room temperature is too hot
Steady Blue	Room temperature is too cold
Steady White	Room temperature is good

LOSS OF CONNECTIVITY BETWEEN THE PARENT UNIT AND THE NURSERY UNIT

- In the case of loss of connectivity, the first step is to bring the Parent Unit and Nursery Unit closer together and make sure that both units are ON to restore the connection. If there is still no connection and no out-of-range warning after the above has been done, then and only then should the re-connection procedure below be done.

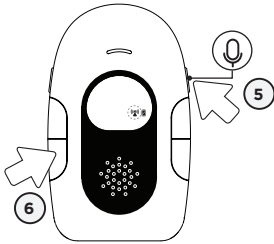
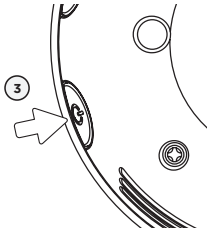

- 1) Turn Parent Unit **OFF**.
- 2) Turn Nursery Unit **OFF** and then turn it **ON**.
- 3) Press the Power **ON/OFF** button on the Nursery Unit 4 consecutive times.

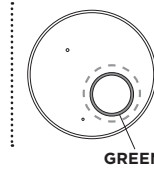

The Sensor Pad Indicator Light on the Nursery Unit will flash quickly in green (indicates Nursery Unit is in linking mode).

- 4) Turn the Parent Unit **ON**. The **Out-of-Range** (📶) icon should blink.
- 5) Press and hold the **Talk Back** button on the Parent Unit until a beep tone is heard.
- 6) Press **OK** button on the Parent Unit. The **Out-of-Range** (📶) icon should blink faster to indicate that the Parent Unit is in linking mode.

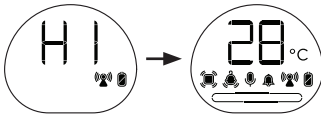

The Parent Unit will display H1-H2 icon during the reconnection procedure. The reconnection is successful if the Parent unit shows the regular screen view.

FALSE ALARMS

- Turn **OFF** the Nursery Unit.
- Make sure there is no bedding between the mattress and the Sensor Pad.
- If the cot has a spring or slat base, place a hardboard between the cot base and the Sensor Pad measuring 6 mm thick and should have minimum dimensions of 33 x 33 cm.
- Make sure the Sensor Pad is positioned as described under the setup requirements.
- You may need to increase the sensitivity, refer to **Step 5.4**.

ALARM WILL NOT SOUND

- Avoid contact with the cot when the monitor is **ON**.
- Place cot near a solid supporting wall to avoid Sensor Pad from detecting movement from outside the cot.
- Turn **OFF** cot mobile, fans, loud music or anything else that may cause vibration.
- You may need to decrease the sensitivity, refer to **Step 5.4**.

NURSERY UNIT POWER ON INDICATOR (GREEN LIGHT) DOES NOT LIGHT UP

- Check connections or change to another electrical outlet.
- Press the Nursery Unit ON/OFF button for 2 seconds to turn the Nursery Unit ON.

WEAK RECEPTION

.....

- Bring units closer together.
- Change the position of one or both units.
- Place units on a flat surface out of baby's reach.
- Replace the batteries or recharge the Parent Unit.

STATIC, DISTORTION, INTERFERENCES (FROM OTHER MONITORS, WIRELESS PHONES, WALKIE-TALKIES, ETC...)

.....

- Rotate the Parent Unit or move it away from source of interference.

FEEDBACK (LOUD NOISES EMITTED FROM THE PARENT UNIT)

.....

- Move units further apart (at least 3 meters apart).
- Decrease volume on the Parent Unit.

THE PARENT UNIT SCREEN IS BLACK (PARENT UNIT IS OFF)

.....

- Turn the Parent Unit back ON by pushing and holding the power button.
- Replace the batteries or recharge the Parent Unit.

SENSOR PAD LIGHT INDICATOR FLASHING RED (MONITOR IS BARELY DETECTING MOVEMENT)

.....

- Make sure there is no bedding between the mattress and the Sensor Pad.
- The Sensor Pad must rest on a completely flat and firm surface. If the cot has a spring or slat base, place a hard board between the cot base and the Sensor Pad measuring 6 mm thick and should have minimum dimensions of 33 x 33 cm.
- Make sure Sensor Pad is positioned as described under the setup requirements.
- You may need to increase the sensitivity, refer to **Step 5.4**.

NO POWER

.....

- Check or replace batteries.
- Make sure Monitor is **ON**.

NURSERY UNIT POWER ON INDICATOR (GREEN LIGHT) DOES NOT LIGHT UP

.....

- Check connections or change to another electrical outlet.
- Press the Nursery Unit ON/OFF button for 2 seconds to turn the Nursery Unit ON.

LIMITED WARRANTY

Angelcare® warrants to the original owner of this product that Angelcare® monitor is free from any material and workmanship defects for the term of the warranty period (see warranty table below to determine the warranty for your country). If this monitoring system fails to function properly when used as directed under normal conditions and during the warranty period, Angelcare® will either repair or replace the product, at our discretion, free of charge. Please contact your local distributor to validate warranty and warranty period.

The product must be accompanied by a proof of purchase, either a bill of sale or other proof that the monitoring system is within the warranty period. Angelcare® will bear the cost of repairing or replacing the product and shipping it back to you.

This warranty does not apply to a product which has been damaged as a result of improper maintenance, an accident, improper voltage supply or any other form of misuse. The warranty is also void if the owner repairs or modifies the product in any way. Angelcare® is not liable for any incidental or consequential damages with regard to this product. The warranty also excludes any liability other than what is stated above. No other warranty is given.

This warranty does not cover products and accessories which are not Angelcare®-branded, or any problems that result from usage that is not in accordance with product instructions, failure to follow the product instructions, or problems caused by using accessories, parts or components not supplied by Angelcare.

LEGAL RIGHTS VARY FROM COUNTRY TO COUNTRY. SOME COUNTRIES DO NOT ALLOW THE EXCLUSION OR LIMITATION OF INCIDENTAL OR CONSEQUENTIAL DAMAGES, SO THE ABOVE LIMITATIONS MAY NOT APPLY TO YOU.

WE ARE NOT IN ANY WAY RESPONSIBLE FOR ANY OUTCOME RESULTING FROM THE USE OF THIS PRODUCT.

IMPORTANT! This Angelcare® monitor is a personal care product. Please do not return this product to the store. If you have questions or need help, please call your distributor before returning this product.

Please contact your local distributor for warranty information. Find your local distributor by visiting our website: www.angelcarebaby.com

TECHNICAL SPECIFICATIONS

Range:

Open field (Open area without obstructions): up to 755 feet (230 meters).

Power Supply:

2 AAA alkaline batteries (not included) or 100/240V AC/5V DC adapter for Nursery Unit.
2 AAA rechargeable batteries and 100/240V AC/5V DC adapter for the Parent Unit.

Caution: To reduce the risk of electric shock, do not expose this product to rain or moisture.

Danger of explosion if batteries are incorrectly replaced. The battery included for the Parent Unit is 2 AAA NiMH rechargeable batteries, manufactured by GPI INTERNATIONAL LIMITED (GN60AAAH, 1.2V, 600mAh). Only use the Angelcare® recommended replacement battery. To obtain information on replacement batteries please contact Angelcare® customer service: www.angelcarebaby.com or contact your local distributor. Instructions will be included with the replacement battery. Dispose of exhausted batteries properly according to your local ordinances. Keep all batteries away from children.

Batteries:

- DO NOT mix old and new batteries.
- DO NOT mix alkaline standard (carbon-zinc), or rechargeable (Ni-CD, NiMH, etc.) batteries.

CAUTION: RISK OF EXPLOSION IF BATTERY IS REPLACED BY AN INCORRECT TYPE.

Transmission:

Transmission between the Parent Unit and the Nursery Unit is made on 1.88 - 1.9 GHz frequency for Europe/Asia/Africa/Australia.

Maximum RF Power Transmitted = 24dBm (250mW)

RF channel no.: 10

Hereby, Angelcare® Monitors Inc, declares that this Baby Monitor is in compliance with Directive 2014/53/EU The full text of the EU declaration of conformity is available at the following internet address: <https://international.angelcarebaby.com/declaration-of-conformity>

See product for compliance marks specific to this device.



PROTECT THE ENVIRONMENT

The whee bin symbols mean that according to local laws and regulations your product and/or its battery shall be disposed of separately from household waste. When the product/battery reaches its end of life take it to a collection point designated by local authorities. The separate disposal and recycling will help conserve natural resources and protect human health and the environment. Refer to User's Guide for removal of batteries.

ErP COMPLIANCE

USE ONLY THE FOLLOWING ANGELCARE® BRAND POWER SUPPLY MODEL NUMBERS:

EUROPEAN UNION (INCLUDING GERMANY) -
K05S050060G
UK - K05S050060B

APPENDIX: INFORMATION ON EXPOSURE TO RADIO WAVES AND SAR (SPECIFIC ABSORPTION RATE)

The design of Parent Unit complies with the current regulations governing exposure to radio waves. These regulations are based on scientific guidelines that indicates safety margins designed to ensure the safety of everyone, regardless of age or state of health. The guidelines on exposure to radio waves use a unit of measurement known as the SAR (Specific Absorption Rate). SAR tests are carried out using standardized method, with the Parent Unit transmitting at the highest certified level of power on all the frequency bands it uses. The maximum SAR level recommended by ICNIRP (International Commission on Non Ionizing Radiation Protection) is 2 W/kg, measured on 10 g of tissue. The highest SAR levels recorded for the Parent Unit are as follows: When used in direct contact with the body 1.8GHz DECT is 0.042W/Kg(10g). When used in front of the face 1.8GHz DECT is 0.021W/Kg(10g). This device complies with the guidelines on exposure to radio frequency both when it is positioned at 0mm from the body or in front of the face.



..... For assistance, FAQs or guidance with your monitor please visit
our Customer Support page at Angelcare.co.uk

www.angelcarebaby.com