

OWNER'S MANUAL

Model AC215

Video, Movement & Sound Monitor



Cord Safety

Ensure the Camera is at least 1 metre away from your baby's cot. The Sensor Pad cord must always be kept out of reach of baby and secured using the cord cover kit provided.

For assistance, FAQs or guidance with your monitor please visit our Customer Support page at angelcare.co.uk

TABLE OF CONTENTS

 WARNINGS.....	2
SETUP REQUIREMENTS	4
STEP 1 - Charging the Parent Unit (9 hours).....	5
STEP 2 - Installing the Sensor Pad	6
STEP 3 - Setting up the Camera.....	9
STEP 4 - Turning on your monitor	10
STEP 5 - Testing and getting to know your monitor.....	11
STEP 6 - Activating and deactivating additional functions.....	15
Troubleshooting	20
Limited warranty.....	22
Technical specifications.....	22

OWNER'S MANUAL

KEEP YOUR OWNER'S MANUAL FOR FUTURE REFERENCE.

PLEASE READ THE WARNINGS AND INSTRUCTIONS CAREFULLY BEFORE ASSEMBLING & USING THE PRODUCT.

FAILURE TO FOLLOW THE WARNINGS AND THE INSTRUCTIONS COULD RESULT IN SERIOUS INJURY OR DEATH OR DAMAGES TO THE PRODUCT.

THE SENSOR PAD FEATURE IS NOT FOR USE WITH ADULTS, CHILDREN OR INFANTS OLDER THAN 24 MONTHS.

THE SENSOR PAD IS NOT INTENDED TO BE USED TO DETERMINE IF A CHILD IS OUT OF THE COT.

⚠️ WARNINGS

1. THIS PRODUCT CANNOT REPLACE RESPONSIBLE ADULT SUPERVISION. This product is designed to aid in the monitoring of your child. When using the monitor, you must still provide the supervision necessary for the continued safety of your child. Monitoring of premature babies, or those considered to be at risk, should always be carried out under the supervision of a health professional. This monitor **SHOULD NOT** be used as a medical device, nor as a device to prevent Sudden Infant Death Syndrome (SIDS).

2. WARNING Strangulation Hazard – Children have **STRANGLING** in cords. Keep adapter cords out of the reach of children (more than 1 meter away). NEVER use Sensor Pad(s) without the protective cord covering. Check protective cord covering before each use. Immediately discontinue use of Sensor Pad(s) if protective covering is damaged or broken.



3. Never use extension cords with adapters. ONLY use the adapters provided.

4. When an adapter is plugged into an electrical outlet, DO NOT touch the exposed end.

5. ALWAYS be sure that both the transmitter and receiver are working properly and are within range of each other. Test the monitor before first use, periodically and when changing

location of the Camera.

6. ALWAYS be sure to immediately check on baby whenever an alarm sounds.

7. DO NOT use monitor near water (such as bath tub, sink, etc.).



8. Keep monitor AWAY from heat sources (such as stoves, radiators, etc.).

9. ALWAYS place both the Camera and the Parent Unit on a flat surface in an upright position and allow for proper ventilation. DO NOT place on sofas, cushions, beds, etc. which may block ventilation.

10. This monitor uses public airwaves to transmit signals. The Parent Unit may pick up signals or interference from other monitors in your area. Your monitor may even be picked up by other households. To protect your privacy, make sure both units are turned **OFF** when not in use. If you experience interference, change the channel on both units.

11. This product is **NOT** a toy. **DO NOT** allow children to play with it.

12. This product contains small parts. Adult assembly required. Exercise care when unpacking and assembling the product and keep small parts away from children.

13. When using the monitor, the room temperature should be between 10°C and 40°C.

⚠️ BATTERY WARNING

14. Danger of explosion if batteries are incorrectly replaced. The Parent Unit battery is a replaceable Li-Ion battery. Only use the Angelcare recommended replacement battery, insert batteries with correct polarity. **DO NOT** short-circuit supply terminals. **ONLY** use the recommended batteries or equivalent (volts and size) and the correct adaptor. Remove battery from Parent Unit when product is stored for long periods of time or when batteries are exhausted. Dispose exhausted batteries properly.

⚠️ WARNING

Adult assembly required.
Keep small parts away from children when assembling.

We, at Angelcare®, stand behind all of our products.

If you are not completely satisfied or have any questions,

United States and Canada: Please contact us at: angelcare@cdecinc.ca

Other countries: Please contact your local distributor.

Keep all batteries away from children.

15. IMPORTANT SAFETY INSTRUCTIONS

15.1 Heed all warnings – All warnings on the product and in the operating instructions should be adhered to.

15.2 Follow all instructions – All operating and use instructions should be followed.

15.3 Water and moisture – **DO NOT** use this apparatus near water. For example, near a bath tub, wash bowl, kitchen sink, laundry tub, in a wet environment or near a swimming pool and the like. Care should be taken so that objects **DO NOT** fall onto units and that liquids are not spilled into either unit or Sensor Pad through its openings.

15.4 Cleaning – Disconnect all units before cleaning. **DO NOT** immerse in water any part of the monitor. Clean only with dry cloth.

15.5 Ventilation – **DO NOT** block any ventilation openings. Allow for proper ventilation when units are in use. **DO NOT** cover the Camera or the Parent Unit with any object such as a blanket. **DO NOT** place it in a drawer or in any location which would muffle the sound or interfere with the normal flow of air.

15.6 Heat sources – **DO NOT** install near any heat sources such as radiators, heat registers, stoves, TVs or other apparatus (including amplifiers) that produce heat. Heat can damage the case or electrical parts.

15.7 Power cord protection – Protect the Sensor Pad cord and Adapter's power cord from being walked on or pinched by furniture or other items – Power supply cords should be routed so that they are not likely to be walked on or pinched by items upon or against them, paying particular attention to cords and plugs, convenience receptacle, and the point where they exit from the product. The socket outlet shall be installed near the equipment and shall be easily accessible. Make sure to plug the adapter to the socket outlet nearest to the equipment and that is easily accessible. To disconnect from mains, unplug the adapter.

15.8 Accessories – Only use attachments/accessories specified by the manufacturer. **DO NOT** place this product on an unstable cart, stand, tripod, bracket or table. The product may fall, causing serious injury to a child or adult and serious damage to the product. Use **ONLY** with a cart, stand, tripod, bracket or table recommended by the manufacturer or sold with the product. Any mounting of the product should follow the manufacturer's instructions.

15.9 Unplug this appliance during lightning storms or when not used for long periods of time.

15.10 Servicing – **DO NOT** attempt to service this product yourself as opening or removing covers (except battery door) may expose you to dangerous voltage or other hazards.

15.11 Replacement parts – When replacement parts are required, be sure the replacement parts specified by the manufacturer have the same characteristic as the original part. Unauthorized substitution may result in fire, electric shock or other hazards.

15.12 Usage – This baby monitor is intended as an aid. It is **NOT** a substitute for responsible and proper adult supervision and should not be used as such. Use this appliance **ONLY** for its intended use as described in this manual.

15.13 Power Sources – Operate this product only from the type of power source indicated on the type plate of the adaptor. If you are unsure of the type of power supply to your home, consult your dealer or local power company.

15.14 Overloading – **DO NOT** overload wall outlets, extension cords or integral convenience receptacles as this can result in a risk of fire or electric shock.

15.15 Object and Liquid Entry – NEVER push objects of any kind into this product through casing slots as they may touch dangerous voltage points or short out parts that could result in a risk of fire or electric shock. NEVER spill liquid of any kind on the product.

15.16 Antenna - The antenna used for this transmitter must be installed provide a separation distance of at least 20 cm from all persons and must not be collocated or operating in conjunction with any other antenna or transmitter.

15.17 Power Lines - An outside antenna system should NOT be located in the vicinity of overhead power lines or other electric light or power circuit, or where it can fall into such power lines or circuits as contact with them may be fatal.

15.18 Vibration Source - When the monitor is in use, DO NOT use a bedside cot, cot mobile or other cot accessories that may produce vibrations. Other sources of vibrations may include fans, washing machines, loud music, etc. These sources of vibration may interfere with the performance of your Angelcare® monitor and the alarm will not sound if it continues to detect any movement other than your baby's. Be sure all vibration sources are eliminated before using the monitor. You may experience false alarms for several reasons. The most common reason is the Camera has not been turned OFF after you have removed your baby from the cot. Another reason is the Sensor Pad has not been placed under the mattress properly. Be sure the Sensor Pad is on a flat, firm surface with the printed side facing up. The sensitivity level may also need to be adjusted. Refer to **Step 5.1**. Always be sure to immediately check on baby whenever an alarm sounds.

15.19 Sensor Pad - Your Sensor Pad can be used in any cot that is stationary. If the cot has a spring or slat base, place a hard board between the cot base and the Sensor Pad measuring at least 33 x 33 cm and 6 mm thick. Only use your Angelcare® monitor in a stationary sleeping environment such as a cot where the Sensor Pad can rest on a completely flat, firm surface. The Sensor Pad is made of plastic and does not permit the air to circulate. Therefore, mildew build up could develop underneath the mattress in the Sensor Pad area. We suggest rotating the mattress regularly to prevent any mildew.

16. I M P O R T A N T S A F E T Y I N S T R U C T I O N S **RELATED TO USE OF BATTERIES**

16.1 Use ONLY the type and size of batteries specified in the owner's manual. There is a risk of explosion if batteries are replaced with an incorrect type.

16.2 Charge the battery for 9 hours prior to first use. Be sure to have the monitor in the **OFF** position during this period. ONLY use the adapters included with your monitor.

16.3 DO NOT use these adapters with any other equipments.

16.4 When unplugging the adapter from the Camera, be sure it is switched to the **OFF** position. If it isn't, the unit will revert to battery mode if batteries are installed.

16.5 DO NOT dispose batteries in fire. They may explode. Check with local regulations for possible special disposal instructions.

16.6 Exercise care in handling batteries in order not to short out the batteries with conducting materials such as rings, bracelets and keys. Overcharging, short circuiting, reverse charging, mutilation, or incineration of batteries must be avoided to prevent one or more of the following occurrences: release of toxic materials, release of hydrogen and/or oxygen, gas and rise in surface temperature.

16.7 DO NOT attempt to recharge batteries provided with or identified for use with this product that are not intended to be charged. The batteries may leak corrosive electrolyte or explode.

16.8 DO NOT attempt to rejuvenate the batteries provided with or identified for use with this product by heating them. Sudden release of battery electrolyte may occur, causing burns or irritation to eyes or skin.

16.9 If and when necessary, the batteries must be replaced with identical new ones or equivalent (volts and size). If a battery to be replaced is connected with other batteries in series, replace the other batteries at the same time as well. DO NOT mix old and new batteries.

16.10 Reverse polarity installation of the batteries in the end product must be avoided. Reverse insertion of batteries can cause charging, and that may result in leakage or explosion.

16.11 Remove batteries from both units if you store the product over 30 days because the batteries could leak and damage the product.

16.12 Discard 'dead' batteries as soon as possible since 'dead' batteries are more likely to leak in a product. If a battery has leaked or vented, it should be replaced immediately using protective gloves.

16.13 DO NOT store this product, or the batteries provided with or identified for use with this product, in high-temperature areas.

SETUP REQUIREMENTS

Model AC215

Video, Movement
& Sound Monitor

INCLUDED:

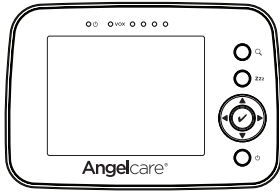

Parent Unit



Camera

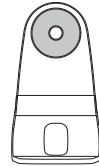

Tabletop stand with removable
wall mount metal ball
(for Camera)

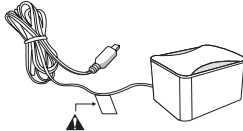

AC adapter
(for Parent Unit)

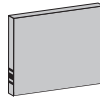

Lithium ion battery pack
(for Parent Unit)

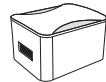

AC adapter
(for Camera)



Wired movement Sensor Pad

* Always place Angelcare logo side up *



(Screwdriver required
for wall mounting)

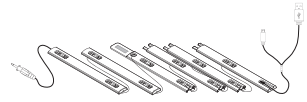

6 Pre-threaded cord covers with
Split USB cable

YOU MUST PREPARE:

One hardboard (not included)
Thickness: **6 mm**
Minimum dimensions:
33 cm x 33 cm
Maximum dimensions:
equal to the mattress size



Hardboard

IMPORTANT

The hardboard must be larger than
the Sensor Pad surface area

WHAT YOU WILL NEED (NOT INCLUDED):



Miniature Philips
Screwdriver

STEP 1 - CHARGING THE PARENT UNIT (9 HOURS)

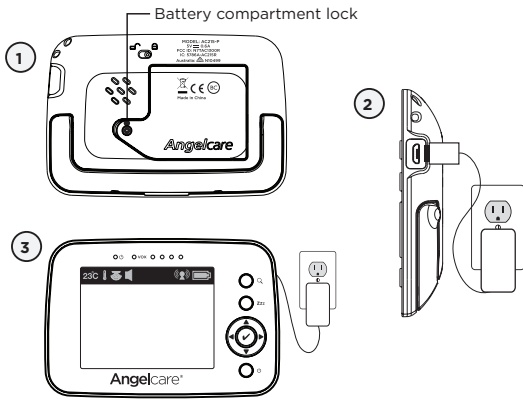

- 1) Unlock the battery compartment on the backside and remove the cover. Insert the provided rechargeable battery into the compartment. Contacts of the battery and the contacts in the compartment must be aligned.
- 2) Connect the adapter to the Parent Unit and into an electrical outlet.
- 3) Charge the unit for **9 continuous hours (prior to first use).**

NOTE:

To optimize your battery performance please refer to Battery Guidelines in the Troubleshooting section.

PARENT UNIT:

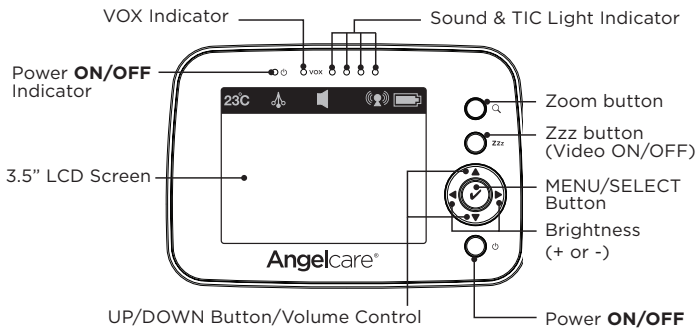

Front Side

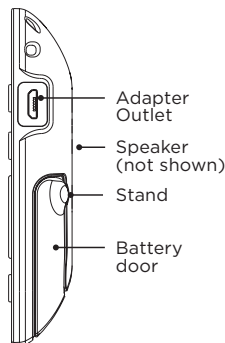

Right Side



⚠️ WARNING

STRANGULATION HAZARD.

Children have STRANGLED in cords:

- Keep adapter cords out of the reach of children (more than 1 meter away).
- Because of the serious strangulation risk to infants and toddlers, parents and caregivers should never place the Camera within 1 meter of a cot.
- **NEVER** use Sensor Pad without the cord covers. Check cord covers before each use to ensure it is securely placed under the leg of the cot. Discontinue use of Sensor Pad if any cord covers are damaged or broken.
- **NEVER** use extension cords with adapters. **ONLY** use the adapters provided. This product is not a toy. Never allow children to play with it.

STEP 2 - POSITIONING THE MOVEMENT SENSOR PAD

2.1 - SELECT A LOCATION FOR THE CAMERA

IMPORTANT

Place the cot near a supporting wall and far from air currents. Install the Camera on a flat, stable surface facing the cot at a distance of at least **1 metre**. Make sure to plug the adapter to the socket outlet nearest to the equipment and that is easily accessible.

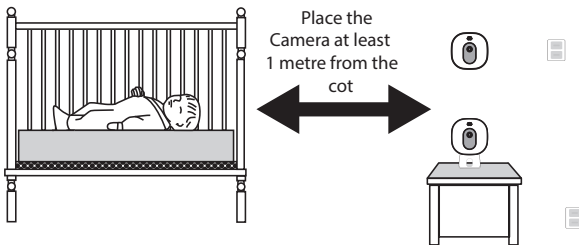

- 1) Insert **jack 1** into the Sensor Pad and twist it clockwise to lock it.

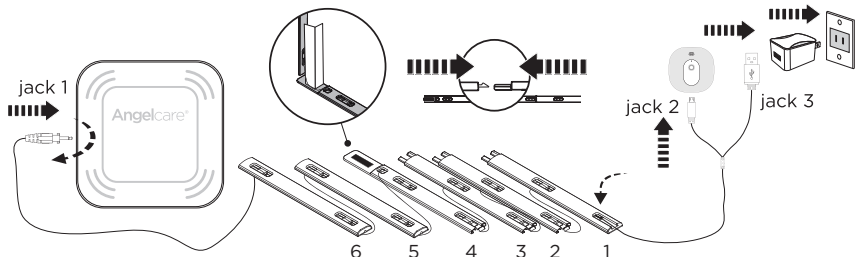

2.2 - SELECT THE COT LEG TO SECURE THE CORD COVERS

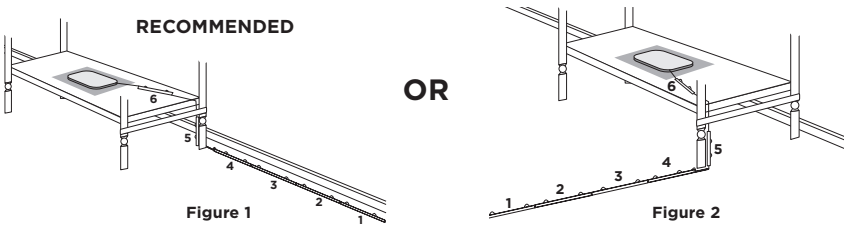

Use the cot leg by the wall closest to the Camera (**Figure 1**). In cases where the Camera is across the room, use the leg closest to the Camera to position the covered wire (**Figure 2**). It is always preferable that the covered cord run along a wall.

2.3 - INSTALL THE SENSOR PAD ON THE MATTRESS SUPPORT

IMPORTANT

If your cot does not have a solid, stable surface for the Sensor Pad, you will need to place a support under it, to ensure correct operation of the system.

This hardboard support should be at least 6 mm thick and should have minimum dimensions of 33 cm x 33 cm. This support board must be larger than the Sensor Pad surface area.

The Sensor Pad functions with any size and type of mattress except memory-foam mattresses, hollow frame mattresses and water beds. The hardboard maintains a constant pressure on the Sensor Pad, enabling it to detect the baby's movements even when the baby is at the edges of the cot.

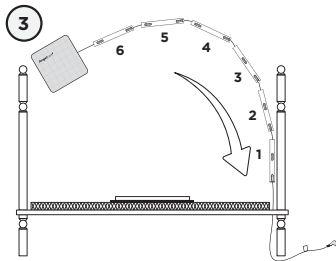
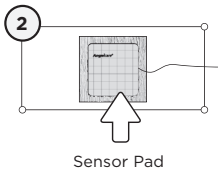
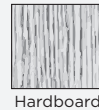

- 1) Remove the mattress from the cot.
- 2) Place the Sensor Pad - **Angelcare logo side up** - on top of the hardboard.
- 3) Run the connection pin, warning label and the first 5 cord covers down along the backside of the cot leg, **between the mattress support and the inside edge of the cot**.

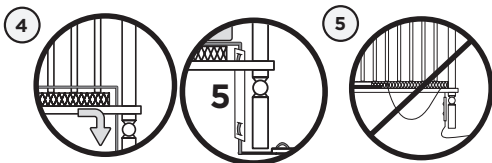

- 4) Bring the first 4 cord covers down the floor, and keep the 5th cord cover vertically, along the backside of the cot leg, **between the mattress support and the inside edge of the cot**.
- 5) Remove any cord slack to make sure no parts of the cord are loose.

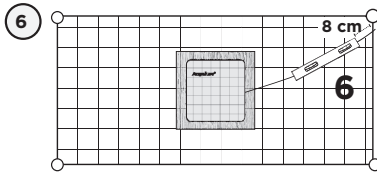

- 6) Place the 6th cord cover approximately **8 cm** from the edge of the mattress support.

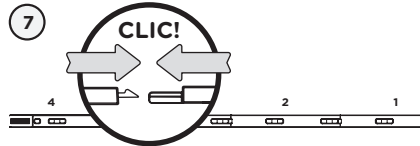

- 7) Snap together the remaining cord covers that will run along the floor.

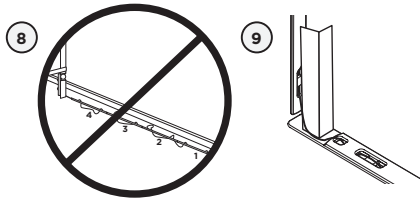

- 8) Remove any cord slack to make sure no parts of the cord are loose.
- 9) Peel off the double-sided tape on the 4th cord cover and place it securely under the cot leg.



WARNING **STRANGULATION HAZARD**

- Remove all slack from Sensor Pad Cord.
- When lowering the mattress support as your child grows, slide the vertical Cord Cover downward so it remains approximately in the center between the mattress support and the floor. Slide the Sensor Pad Cord through the Floor Cover to eliminate any additional slack.

- The Sensor Pad is not designed for use with adults, children or infants older than 24 months.
- Discontinue used of the Sensor Pad when child is older than 24 months. Remove Sensor Pad from cot and store for future use.
- **BEFORE FIRST TIME USE:** To test that the unit is ready for use, refer to instruction manual on how to test that the installation has been done correctly.

STEP 3 - SETTING UP THE CAMERA

Camera can be installed on the wall (see included parts) or using the tabletop stand. Depending on the position you choose, you'll need to remove the metal ball from the stand to wall mount camera.

**MUST BE MORE THAN
1 METRE AWAY**

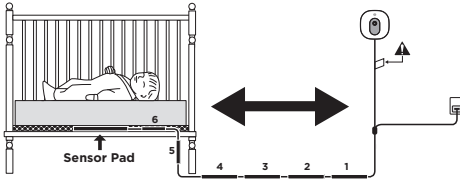

OR

**MUST BE MORE THAN
1 METRE AWAY**

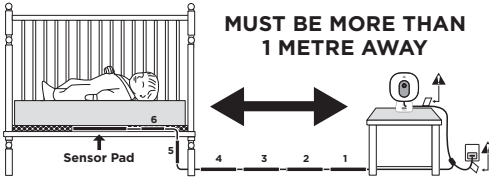

- 1) Install the Camera on a flat, stable surface facing the cot at a distance of at least **1 metre** and plug the Sensor Pad cord into the Camera.
- 2) Check to make sure the Sensor Pad has not moved from position.
- 3) Place the mattress back inside the cot.

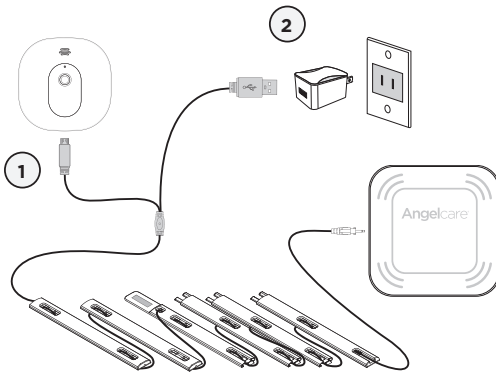

- 1) Connect the USB plug to the Camera.
- 2) Connect the USB plug with the power adapter and then with an electrical outlet.
- 3) Adjust the Camera using the magnetic mount to get the best view of baby in the cot.

CAMERA

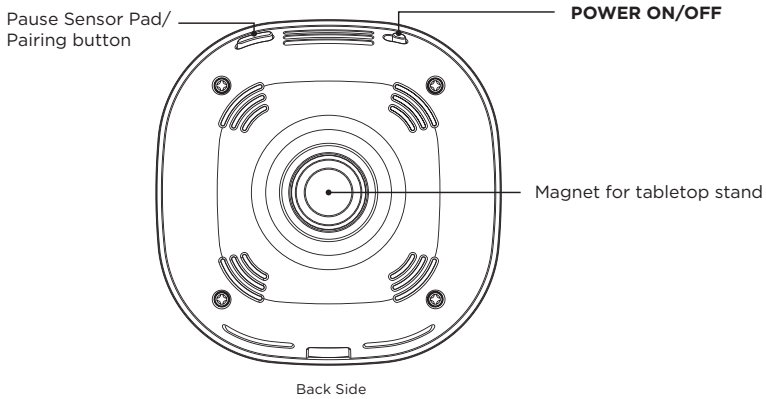
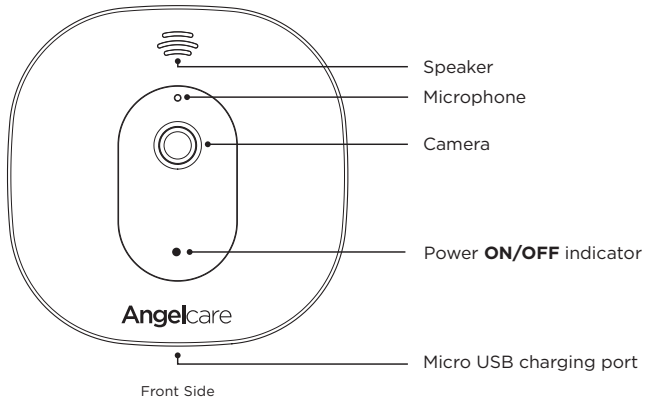

STEP 4 - TURNING ON YOUR MONITOR

Your Camera and Parent Unit come pre-paired, so you should see video within 3 - 4 seconds of turning ON the units. The Camera connection signal strength icon will appear in the status bar.

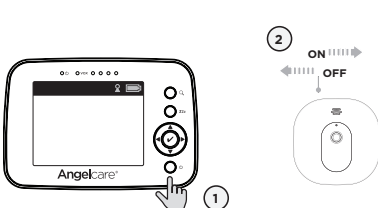

- 1) Press and hold the Parent Unit **ON/OFF** button for 2 seconds until LCD screen is turned **ON**. Angelcare's logo will be shown for 1 second.
- 2) Slide the Camera **ON/OFF** switch to the **ON** position.
- 3) The Parent Unit will display **Video** mode screen.



When Parent Unit is turned **ON** and Camera is **OFF**, Parent Unit will display **Out-of-Range** icon.



If there is a lost connection between the 2 units after 15 seconds, the **Out-of-Range** alarm will sound on the Parent Unit (refer to **Troubleshooting** section):

- The **Out-of-Range** icon will appear on the screen.

INFO BAR IMPORTANT ICONS



23°C

Temperature icon: Indicates room temperature



Temperature Alarm icon: Indicates Temperature Alarm is active



Pendulum icon: Indicates the Movement Sensor is active



Night View Mode icon: Indicates the Camera is in Night View Mode



Sound icon: Indicates that Sound function is active

Connection icon: Indicates the connection quality between the Parent Unit and the Camera.



Good connection



Poor connection



Lost connection

Battery Level icon: Indicates battery level

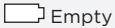

Empty

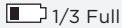

1/3 Full

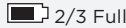

2/3 Full



Full

STEP 5 - TESTING AND GETTING TO KNOW YOUR MONITOR

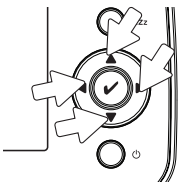

The Angelcare® monitor can be used with the pre-program factory settings or you can also customize your settings to your preference. Main menu on the LCD display shows the different operation settings. Use the direction keys to change or check the different functions on the Parent Unit.

Press the **Menu/Select** button to highlight selected icon in blue.

Press the **Menu/Select** button to change from blue to green to show preferred setting is selected. Press the **Zzz** button to exit or go back to main menu when in sub-menu.

IMPORTANT

When in menu or sub-menu modes, sound transmission between the Parent Unit and the Camera will be temporarily deactivated. ONLY movement-detection alarm will remain active (if function is activated).

5.1 - SENSOR PAD

IMPORTANT

- Test your monitor before first use.
- Test your monitor regularly to ensure it is functioning correctly.
- Test your monitor every time you move the Sensor Pad to a different place.

TO ACTIVATE THE SENSOR PAD:

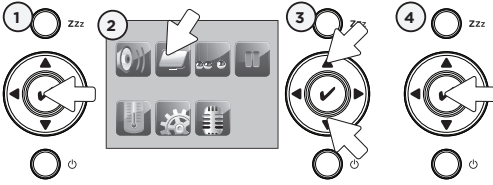

- 1) Press **Menu/Select** button to access main menu.
- 2) Select the **Movement** icon by pressing the **right arrow**.
- 3) Use the up and down arrows to **activate** or **deactivate** the **Movement Alarm**.
- 4) Press **Menu/Select** button to confirm.
- 5) Return to camera view by pressing **Zzz** button.

TO TEST THE SENSOR PAD:

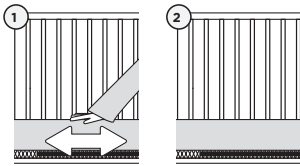

⋮  When movement is activated the static **pendulum icon** shows in info bar

- 1) Move your hand lightly on the mattress.
- 2) Remove your hand from the mattress. After 15 seconds you will hear a '**TIC**' pre-alarm sound, and 5 seconds later the **Movement Alarm** will trigger.

MOVEMENT ALARM

- Alarm activates when no movement is detected by the Sensor Pad for 20 seconds.
- Both the Parent Unit and the Camera speakers will emit loud continuous beeps.
- **Movement Alarm** icon will show on the LCD screen.



IF THE ALARM DOES NOT SOUND

- Avoid contact with the cot while Sensor Pad is in operation.
- Place the cot near a supporting wall.
- Adjust the Sensor Pad sensitivity level.
- Turn **OFF** cot mobile, fans, loud music or anything else that may cause vibration.

TO STOP THE ALARM

Press any key of the Parent Unit to stop the alarm.

OR

Press the **Pause** Sensor Pad button on the Camera.



TO ADJUST THE SENSOR PAD SENSITIVITY LEVEL:

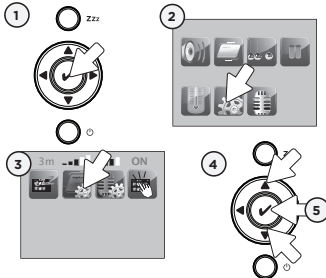

- 1) Press **Menu/Select** button to access main menu.
- 2) Select the **Settings** icon to access sub-menu.
- 3) Select the **Movement Sensitivity** icon.
- 4) Use the up and down arrows to choose the desired sensitivity level (**1 = Low** to **5 = High**).



- 5) Press **Menu/Select** button to confirm.

NOTE:

If you are receiving false alarms, adjust the sensitivity level. Please only adjust if required.

TO ACTIVATE THE TIC FUNCTION:

Allows you to hear a **TIC** sound when Sensor Pad function is activated.

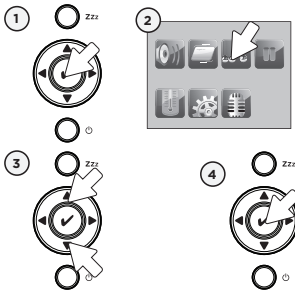

- 1) Press **Menu/Select** button to access the main menu.
- 2) Select the **TIC** icon.
- 3) Use the up and down arrows to **activate** or **deactivate** the **TIC** function.
- 4) Press **Menu/Select** button to confirm.

Regular **TIC** sound will emit from Parent Unit.

NOTE:

Make sure the Sensor Pad is activated before activating the **TIC** function.

IMPORTANT

- The Sensor Pad is not designed for use with adults, children or infants older than 24 months.
- Once you are finished using the Sensor Pad, deactivate the movement function and store safely away for future use.

5.2 - SOUND

TO ACTIVATE/DEACTIVATE SOUND

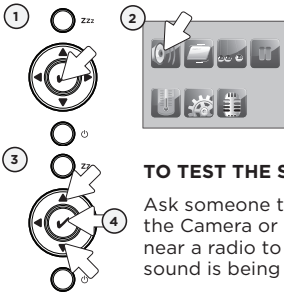

TO TEST THE SOUND:

Ask someone to speak into the Camera or place the unit near a radio to ensure that sound is being picked up.

- 1) Press **Menu/Select** button to access main menu.
- 2) Select the **Sound** icon.
- 3) Use the up and down arrows to **activate** or **deactivate** the sound.
- 4) Press **Menu/Select** button to confirm.

IF YOU HEAR NO SOUND:

- Check that both units are powered **ON**.
- Check that both units are plugged into functioning electrical outlets.
- Check the batteries in both units (replace or recharge them if necessary).
- Bring the Parent Unit closer to the Camera.

IMPORTANT

To avoid feedback (whistling), keep both units at least 3 meters apart.

ADJUST SOUND LEVEL



Increase volume
(Up arrow)

Lower volume
(Down arrow)

PUT IN SILENT/MUTE MODE



Press the down arrow for 2 seconds to mute sound. **Mute** icon will flash in Info Bar. Press again for 2 seconds to reactivate sound.

5.3 - BATTERY

HOW TO CHECK THE BATTERY:

Unplug the adapter from the Parent Unit and check the battery level indicator.

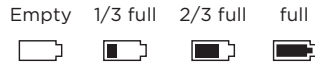
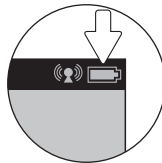

HOW TO CHARGE THE BATTERY IN THE PARENT UNIT:

Leave the Parent Unit plugged in to fully charge the unit. Although the battery at 1/3 capacity works normally, we recommend that you fully recharge it.

PARENT UNIT BATTERY ALERT

- Alert activates when the battery needs to be recharged.
- Parent Unit will emit a beep sound every 15 seconds.
- **Empty** icon will show on LCD screen.

YOU ARE NOW READY TO USE YOUR MONITOR

The Angelcare® monitor can be used with the pre-program factory settings or you can also customise your settings to your preference.

DEFAULT SETTINGS



Sound Mode: ON
Speaker Volume: Level 3 (of 6)



Movement Mode: ON
Sensor Pad Sensitivity: Level 3 (of 5)
TIC: OFF



Temperature Unit: Celsius
Temperature Alarm: OFF



VOX: ON



VOX Level: Level 2 (of 4)



Screen Saver Timer: ON
(after 3 minutes)



LCD Brightness: Level 3 (of 5)



Key Tone: ON

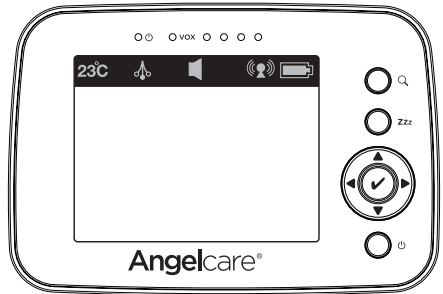

IMPORTANT

- Test your monitor before first use.
- Test your monitor regularly to ensure it is functioning correctly.
- Test your monitor every time you move the Sensor Pad to a different place.

STEP 6 - VOICE ACTIVATION (VOX ON) OR CONTINUOUS SOUND (VOX OFF) MODE

IMPORTANT

When in the menu or sub-menu modes, sound transmission between Parent Unit and Camera will be temporarily deactivated. ONLY the movement detection alarm will remain active (if function is activated).

6.1 - VOICE ACTIVATION (VOX) OR CONTINUOUS SOUND MODE

Allows you to select your option on how you monitor sound: **VOX** (voice activation picks up sound based on the setting of the sensitivity level) or **Continuous** (sound monitoring is continuously on, picking up all sounds).

TO DEACTIVATE OR ACTIVATE VOX MODE:



- 1) Press **Menu/Select** button to access the main menu.
- 2) Select the **VOX** icon to **activate** or **deactivate** the VOX function.
- 3) Press **Menu/Select** button to confirm.

NOTE:

By deactivating **VOX**, Continuous Sound setting will turn **ON**.

TO ADJUST THE SOUND SENSITIVITY (VOX):

Allows you to determine the sound level needed to trigger sound transmission to the Parent Unit. This means that sound will only transmit based on the level that you set.

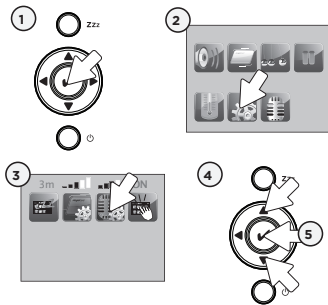

- 1) Press **Menu/Select** button to access the main menu.
- 2) Select the **Settings** icon to access sub-menu.
- 3) Select the **VOX Sensitivity** icon.
- 4) Use the up and down arrows to choose the desired sensitivity level (1 = LOW to 4 = High).
 -
 -
 -
 -
- 5) Press **Menu/Select** button to confirm.

6.2 - HOLD

Allows you to pause the monitor if you remove baby from the cot, e.g. for feeding or comforting.

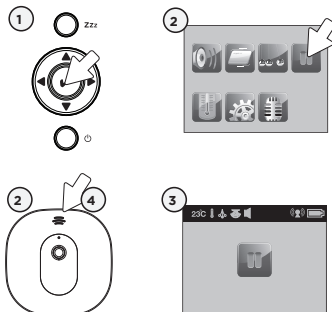

- 1) Press **Menu/Select** button to access main menu.
- 2) Select the **Hold** icon.
OR
Press the Camera **Pause** button
- 3) **Hold** icon will appear on the screen.
- 4) Press the Camera **Pause** again to return to deactivate **Hold**.

.....

Camera **Indicator** (green light) will blink. Parent Unit will emit 3 consecutive beeps every 30 seconds to remind you that monitor is on **Hold**.

IMPORTANT

When your monitor is on **Hold**, the movement-detection feature and movement alarm are disabled.

6.3 - THERMOMETER

TO CHANGE THE MEASUREMENT UNIT:

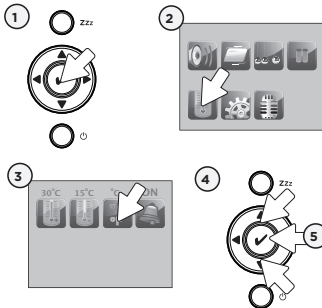

- 1) Press **Menu/Select** button to access main menu.
- 2) Select the **Temperature** icon to access sub-menu.
- 3) Select the **°C °F** icon.
- 4) Use the up and down arrows to change from **Celsius** to **Fahrenheit**.



- 5) Press **Menu/Select** button to confirm.

TO ACTIVATE THE TEMPERATURE ALARM:

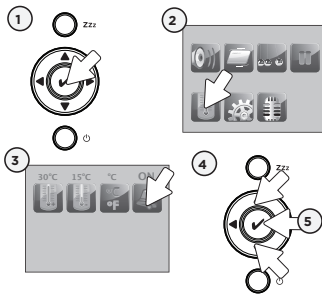

- 1) Press **Menu/Select** button to access main menu.
- 2) Select the **Temperature** icon to access sub-menu.
- 3) Select the **Temperature Alarm** icon.
- 4) Use the up and down arrows to **activate** or **deactivate** the **Temperature Alarm**.

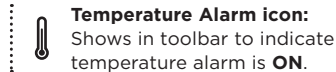

- 5) Press **Menu/Select** button to confirm.

TO SET THE TEMPERATURE RANGE:

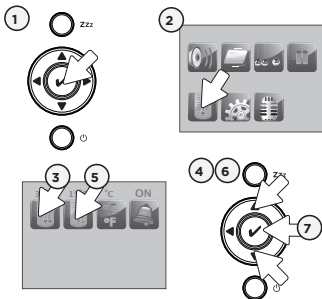

- 1) Press **Menu/Select** button to access main menu.
- 2) Select the **Temperature** icon to access sub-menu.
- 3) Select the **High Temperature** icon to set **maximum** temperature range (15 to 32 °Celsius).
- 4) Use the up and down arrows to set the highest temperature preferred.
- 5) Select the **Low Temperature** icon to set **minimum** temperature range (5 to 20 °Celsius).
- 6) Use the up and down arrows to set the lowest temperature preferred.
- 7) Press **Menu/Select** button to confirm.

The range between the minimum and maximum temperature must be at least 4 °C/7 °F. An error tone will be heard if you try to set it up below this minimum level.



TEMPERATURE ALARM

- Alarm activates when temperature reaches maximum or minimum set temperature.
- Parent Unit will emit 4 consecutive beeps, every 5 seconds.
- **Temperature Alarm** icon will show on LCD screen.

6.4 - SCREEN SAVER

Allows you to set the screen saver starting point.

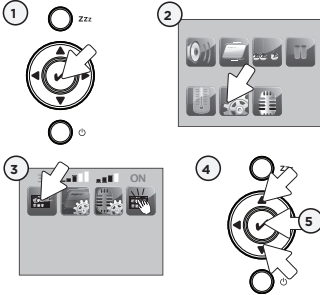

- 1) Press **Menu/Select** button to access main menu.
- 2) Select the **Settings** icon to access sub-menu.
- 3) Select the **Screen Saver** icon.
- 4) Use the up and down arrows to select timed delay before **Video** mode turns into **Screen Saver** mode.
- 5) Press **Menu/Select** button to confirm.

MANUAL SETTING:

To manually activate the **Screen Saver** mode press and hold the Parent Unit **Zzz** button.

NOTE:

The LCD screen will turn black when video is in **Screen Saver** mode. Press any button to return to **Video** mode.

6.5 - INFRARED NIGHT VISION

Allows you to capture image when lighting is insufficient.



A **Night View** icon will appear at the top of the Parent Unit screen.



The **Night View** icon will disappear at the top of the Parent Unit screen.

- 1) The infrared LEDs will turn **ON** automatically when the lighting is not sufficient, to give a night view on LCD display.

Note:

- When the **Infrared Night Vision** is **ON**, only black and white image will be displayed on the LCD screen.
- 2) If the light is bright enough in the room, the infrared LED on the Camera will turn **OFF** automatically.

6.6 - ZOOM MODE

Allows you to zoom in to twice the normal view.

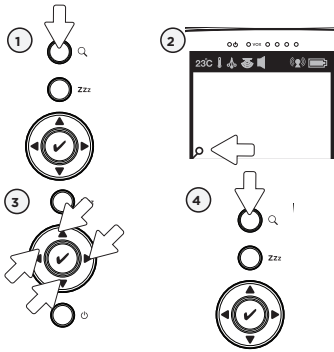

- 1) Press and release the **Zoom** button on the Parent Unit.
- 2) The **Zoom** icon will appear at the bottom left corner of the screen.
- 3) Use the **arrow keys** to zoom in on what you want to see more closely.
- 4) Press and release the **Zoom** button on the Parent Unit again to return to normal view.

6.7 - KEY TONE

Allows you to activate or deactivate key tone sound.

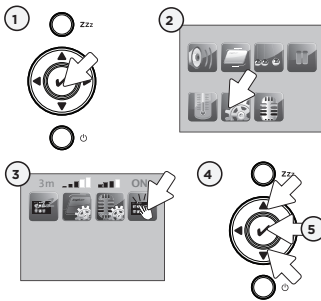

- 1) Press **Menu/Select** button to access main menu.
- 2) Select the **Settings** icon to access sub-menu.
- 3) Select the **Key Tone** icon.
- 4) Use the up and down arrows to **activate or deactivate Key Tone** sound.
- 5) Press **Menu/Select** button to confirm.

6.8 - LCD SCREEN BRIGHTNESS

Allows you to adjust the LCD screen brightness on the Parent Unit.

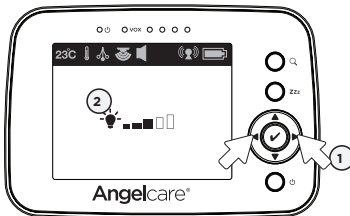

- 1) Use the left and right arrows to adjust the screen brightness level (1 = LOW to 5 = High).
- 2) A light bulb will be shown on the LCD screen.

TROUBLESHOOTING

TAKING CARE OF YOUR RECHARGEABLE BATTERY

- Ensure that you fully charge your battery for 9 hours before first use.
- To maintain maximum battery life it is recommended that you fully discharge your battery periodically. If your Parent Unit is not in use, please turn it **OFF**.

LOSS OF CONNECTIVITY

In the case of loss of connectivity, the first step is to bring the Parent Unit and Camera closer together and make sure that both units are ON to restore the connection. If there is still no connection and no out-of-range warning after the above has been done, then and only then should the re-connection procedure below be done.

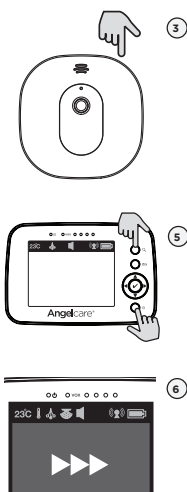

- 1) Turn both Unit **OFF**
- 2) Turn the Nursery Unit **ON**.
- 3) Press and hold the **Pause** button on the Camera till the Power Indicator Light blinks green, then release the button.
- 4) Turn the Parent Unit **ON**.
- 5) Whilst still pressing the **Zoom** button, quickly press and release the **ON/OFF** button.
- 6) The Parent Unit will display a forward icon during the reconnection procedure. The reconnection is successful if Parent unit shows the camera view. The **Zoom** button can be release.

FALSE ALARMS

- Turn **OFF** the Camera.
- Verify the connection between the Sensor Pad and the Camera. Unplug and reconnect the cord.
- Make sure there is no bedding between the mattress and the Sensor Pad.
- If the cot has a spring or slat base, place a hardboard between the cot base and the Sensor Pad measuring at least 33 x 33 cm and 6 mm thick.
- Make sure the Sensor Pad is positioned as described under the setup requirements. Sensitivity may need to be adjusted, refer to **Step 5.1**.

ALARM WILL NOT SOUND

- Avoid contact with the cot when the monitor is **ON**.
- Place cot near a solid supporting wall to avoid Sensor Pad from detecting movement from outside the cot.
- You may need to decrease the sensitivity, refer to **Step 5.1**.

NO SOUND IS BEING TRANSMITTED

- Bring the Parent Unit closer to the Camera.
- Recharge the Parent Unit.
- Check connections or change to another electrical outlet.
- Ensure both units are **ON**.
- Ensure mains supply units are activated.
- Check on the top bar of the Parent Unit to see if the monitor is on **MUTE** instead of **ON**. Refer to **Step 5.2**.

CAMERA POWER ON INDICATOR (GREEN LIGHT) DOES NOT LIGHT UP

- Check connections or change to another electrical outlet.
- Slide the Camera **ON/OFF** switch to the **ON** position.

WEAK RECEPTION

- Bring units closer together.
- Change the position of one or both units.
- Place units on a flat surface away from baby's reach.
- Recharge the Parent Unit.

STATIC, DISTORTION, INTERFERENCES (FROM OTHER MONITORS, WIRELESS PHONES, WALKIE-TALKIES, ETC.)

- Rotate Parent Unit or move it away from source of interference.

FEEDBACK (LOUD NOISES EMITTED FROM THE PARENT UNIT)

- Move units farther apart (at least 3 meters).
- Decrease volume on Parent Unit.

THE PARENT UNIT SCREEN IS BLACK (PARENT UNIT IS OFF)

- Turn the Parent Unit back **ON** by pushing and holding the **POWER ON/OFF** button for 2 seconds.
- Recharge the Parent Unit.

LIMITED WARRANTY

Angelcare® warrants to the original owner of this product that Angelcare® monitor is free from any material and workmanship defects for the term of the warranty period (see warranty table below to determine the warranty for your country). If this monitoring system fails to function properly when used as directed under normal conditions and during the warranty period, Angelcare® will either repair or replace the product, at our discretion, free of charge. Please contact your local distributor to validate warranty and warranty period.

The product must be accompanied by a proof of purchase, either a bill of sale or other proof that the monitoring system is within the warranty period. Angelcare® will bear the cost of repairing or replacing the product and shipping it back to you.

This warranty does not apply to a product which has been damaged as a result of improper maintenance, an accident, improper voltage supply or any other form of misuse. The warranty is also void if the owner repairs or modifies the product in any way. Angelcare® is not liable for any incidental or consequential damages with regard to this product. The warranty also excludes any liability other than what is stated above. No other warranty is given.

This warranty does not cover products and accessories which are not Angelcare-branded, or any problems that result from usage that is not in accordance with product instructions, failure to follow the product instructions, or problems caused by using accessories, parts or components not supplied by Angelcare.

LEGAL RIGHTS VARY FROM COUNTRY TO COUNTRY. SOME COUNTRIES DO NOT ALLOW THE EXCLUSION OR LIMITATION OF INCIDENTAL OR CONSEQUENTIAL DAMAGES, SO THE ABOVE LIMITATIONS MAY NOT APPLY TO YOU. WE ARE NOT IN ANY WAY RESPONSIBLE FOR ANY OUTCOME RESULTING FROM THE USE OF THIS PRODUCT.

IMPORTANT! This Angelcare® monitor is a personal care product. Please do not return this product to the store. If you have questions or need help, please call your distributor before returning this product.

Please contact your local distributor for warranty information. Find your local distributor by visiting our website: www.angelcarebaby.com

WARRANTY TERM PER COUNTRY	
North America	1 year
UK, South Africa, Russia	1 year
Other Countries	2 years

TECHNICAL SPECIFICATIONS

Range:

Open field (Open area without obstructions): up to 250 meters.

Number of Channels:

USA/Canada: 19 channels.
Europe: 64 channels.

Power Supply:

1 included Li-Ion battery (Parent Unit)
100 - 240 VAC / 5 VDC adapter for the Parent Unit
100 - 240 VAC / 5 VDC adapter for the Camera

Caution: To reduce the risk of electric shock, do not expose this product to rain or moisture.

Danger of explosion if batteries are incorrectly replaced. The battery included for the Parent Unit is a user replaceable Li-ion rechargeable battery, manufactured by SPRINGPOWER TECHNOLOGY (SHENZHEN) COMPANY LIMITED. Only use the Angelcare recommended replacement battery. To obtain information on replacement batteries please contact Angelcare customer service: www.angelcarebaby.com or contact your local distributor. Instructions will be included with the replacement battery. Keep all batteries away from children.

Batteries:

RISK OF EXPLOSION IF BATTERY IS REPLACED BY AN INCORRECT TYPE.

See product for compliance marks specific to this device.



Transmission:

Data transmission between the Parent Unit and the Camera is made on the 2.4 GHz frequency.

Maximum RF Power Transmitted = 20dBm (100mW)

Hereby, Angelcare Monitors Inc., declares that this Baby Monitor is in compliance with Directive 2014/53/EU The full text of the EU declaration of conformity is available at the following internet address: <https://international.angelcarebaby.com/declaration-of-conformity>.

ErP COMPLIANCE

USE ONLY THE FOLLOWING ANGELCARE® BRAND POWER SUPPLY MODEL NUMBERS:

EUROPEAN UNION (INCLUDING GERMANY) -
K05S050060G
UK - K05S050060B

PROTECT THE ENVIRONMENT

the wheellie bin symbols mean that according to local laws and regulations your product and/ or its battery shall be disposed of separately from household waste. When the product/ battery reaches its end of life take it to a collection point designated by local authorities. The separate disposal and recycling will help conserve natural resources and protect human health and the environment. Refer to User's Guide for removal of batteries.

EC DECLARATION OF CONFORMITY



Issue Date: 30 June, 2017
Device (s): Angelcare Model numbers as listed below
Description: Baby Monitors as described in Device list below
Manufacturer: Angelcare Monitors Inc
201 boul. De L'industrie Local 104
Canidac, QC J5R 6A6 Canada

We declare under our own responsibility that the products herein are in accordance with the essential requirements of the relevant Union harmonization legislation –

The Radio Equipment Directive (RED) 2014/53/EU.

Relevant Harmonized standards used:

Article 3.1(a) – Health & Safety

EN60950-1:2006+A11:2009+A1:2010+A12:2011+A2:2013

EN62311:2008

EN 50566:2013

Article 3.1(b) - EMC

EN301 489-1 V2.2.0

EN301 489-17 V3.2.0

Article 3.2 – Radio

EN 300 328 V2.1.1

Device List –

Model No. AC210 – Video & Sound Baby Monitor

Model No. AC215 – Video, Movement and Sound Baby Monitor

Authorized Signature:

.....
For assistance, FAQs or guidance with your monitor please visit
our Customer Support page at Angelcare.co.uk

www.angelcarebaby.com