

# Bentwood Chair

Assembly Instructions - Please keep for future reference

600/6053

**COLOUR**

600/6022

**MATCH**

248/3993

**BY ARGOS**

241/6764

702/3994

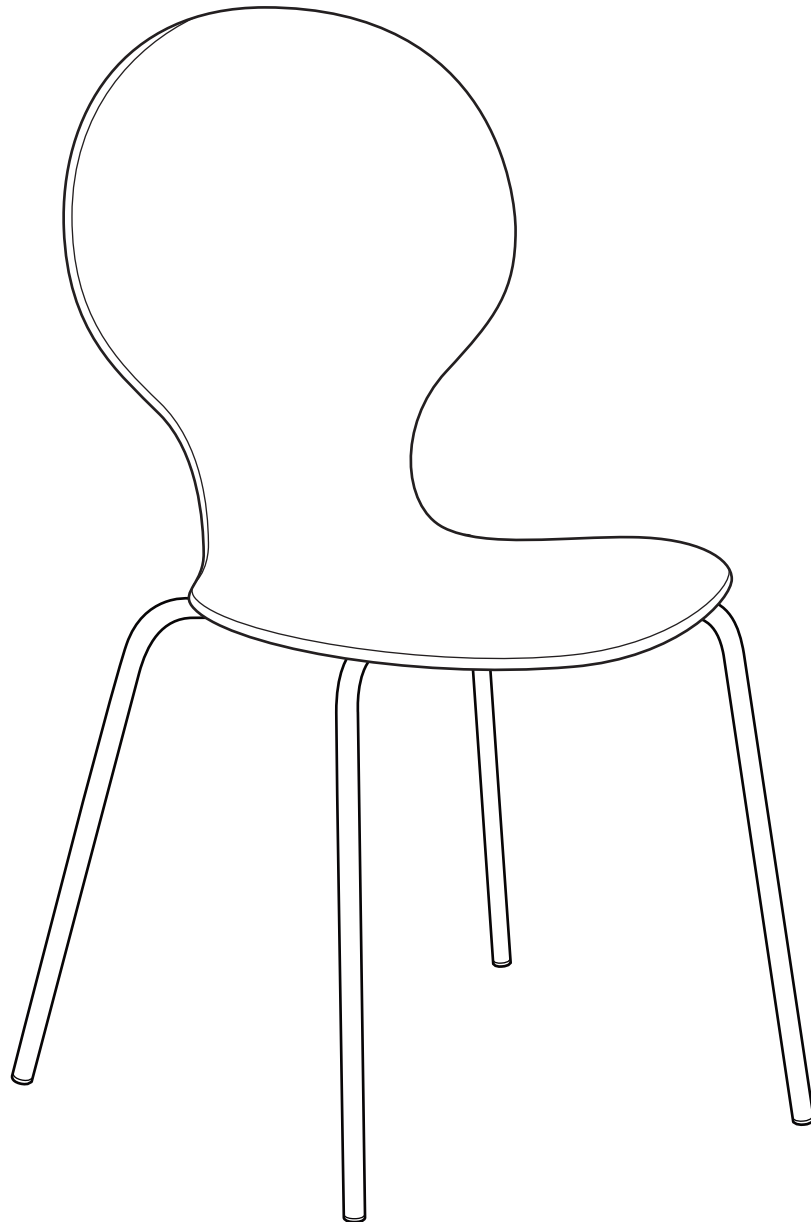

## Dimensions

Width - 47cm

Depth - 52cm

Height - 87cm

**Important - Please read these instructions fully before starting assembly**

If you need help or have damaged or missing parts, call the **Customer Helpline:**  
**Argos = 0345 640 0800**



# Safety and Care Advice

**Important - Please read these instructions fully before starting assembly**

- Check you have all the components and tools listed on the following pages.
- Remove all fittings from the plastic bags and separate them into their groups.
- Keep children and animals away from the work area, small parts could choke if swallowed.
- Make sure you have enough space to layout the parts before starting.
- During assembly do not stand

or put weight on the product, this could cause damage.

- Assemble the item as close to its final position (in the same room) as possible.
- Assemble on a soft level surface to avoid damaging the unit or your floor.
- Parts of the assembly will be easier with 2 people.
- Do not stand on the chair.
- Do not use this chair as step ladder.



• We do not recommend the use of power drill/drivers **for inserting screws**, as this could damage the unit. Only use hand screwdrivers.

- Unit weight: 3.8 kgs.
- Maximum safe weight of user: 110kgs.

## Care and maintenance

- Only clean using a damp cloth and mild detergent, do not use bleach or abrasive cleaners.
- From time to time check that there are no loose screws on this unit.
- This product should not be discarded with household waste. Take to your local authority waste disposal centre.

## Handy Hints

- Assemble all parts and bolts loosely during assembly, only once the product is complete should you fully tighten the bolts.
- Regularly check and ensure that all bolts and fittings are tightend properly.

# Components - Parts

If you have damaged or missing components, call the Customer Helpline: Argos = 0345 640 0800

Please check you have all the parts listed below

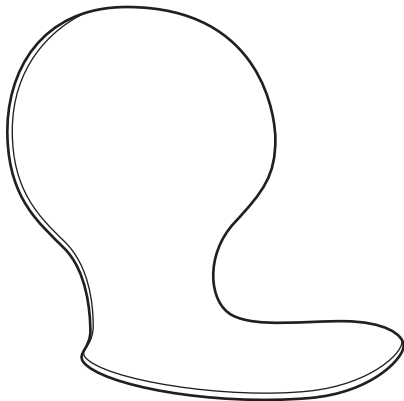

**1** Seat  
(42.5 x 53 x 43cm)

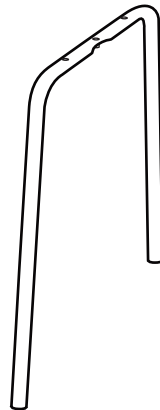

**2** Upper Leg  
(65.5 x 41.5 x 1.6cm)

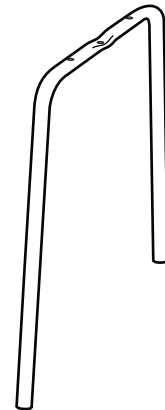





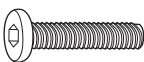
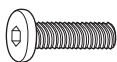

**3** Lower Leg  
(65.5 x 41.5 x 1.6cm)

# Components - Fittings

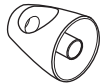
Please check you have all the fittings listed below

**Note:** The quantities below are the correct amount to complete the assembly. In some cases more fittings may be supplied than are required.

<p><b>A</b> </p> <p>M6 x 30mm Bolt x 4</p>	<p><b>B</b> </p> <p>M6 x 15mm Bolt x 1</p>	<p><b>C</b> </p> <p>Split Washer x 5</p>	<p><b>D</b> </p> <p>Leg Holder x 4</p>
<p><b>E</b> </p> <p>Big Footing x 4</p>	<p><b>F</b> </p> <p>Small Footing x 4</p>	<p><b>G</b> </p> <p>Allen key x 1</p>	

## Tools required



Crosshead screwdriver

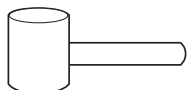

Rubber Mallet

## Ruler - Use this ruler to help correctly identify the screws

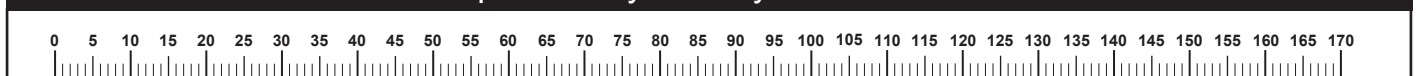

# Assembly Instructions

## Step 1

### Attaching leg holders

Position and insert the leg holders **D** into legs **2** & **3** as shown. Move it up to the holes on the top surface of the legs.

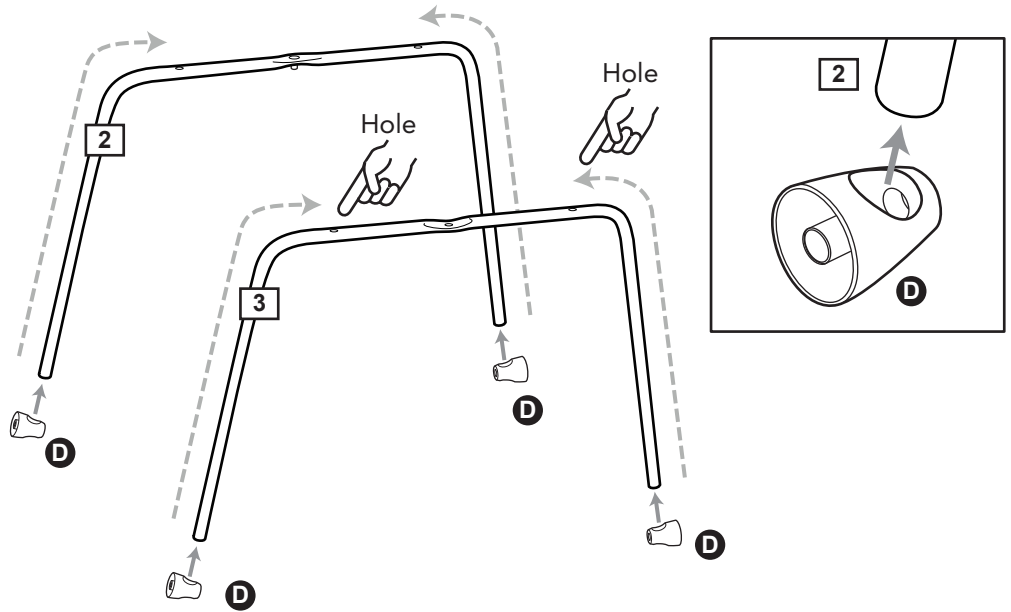

## Step 2

### Attaching big footings

Insert big footings **E** on the ends of the legs **2** & **3** as shown. Press firmly to secure.



**Note:** Insert and lock it carefully into holes by using a rubber mallet.

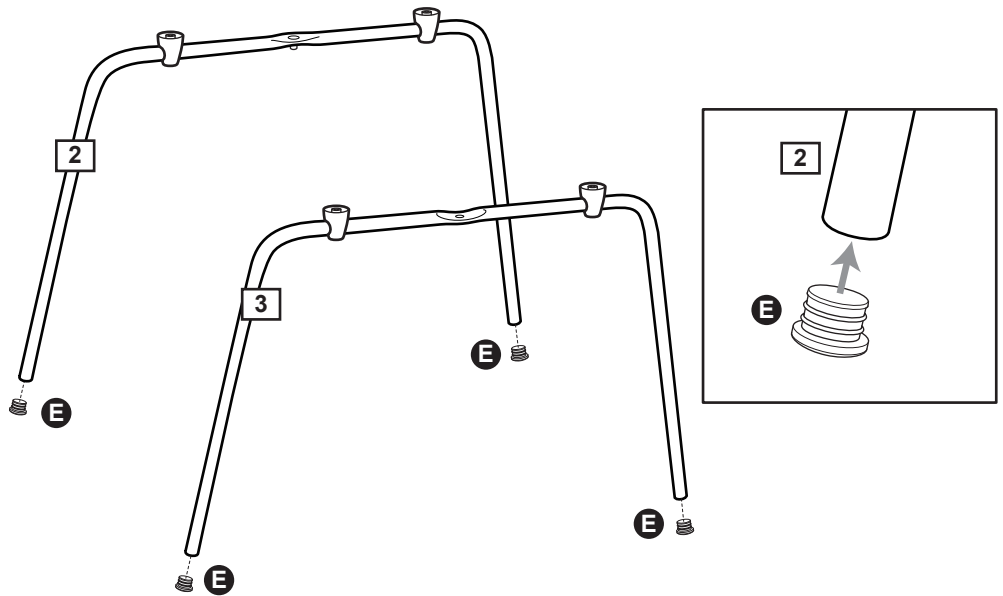

## Step 3

### Attaching legs

Position the legs upside down as shown. Place the upper leg **2** below the lower leg **3**. Then fix through holes using bolt **B** and spring washer **C**.

### IMPORTANT NOTE:

Fasten bolt using allen key but do not fully tighten at this stage.

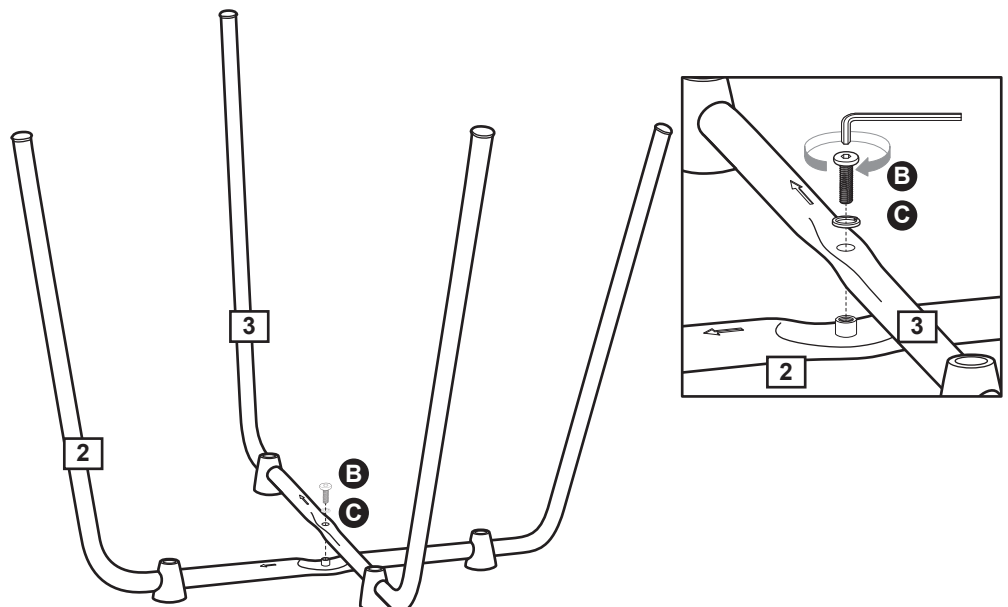

# Assembly Instructions

## Step 4

### Attaching seat

Place seat **1** upside down on a raised protected surface and position legs **2** & **3** on the seat as shown.

**IMPORTANT NOTE:**  
Make sure the arrow on the legs are pointing to the front of the seat as shown.

Then fix through holes on the leg holders **D** & legs with bolts **A** & spring washers **C**.

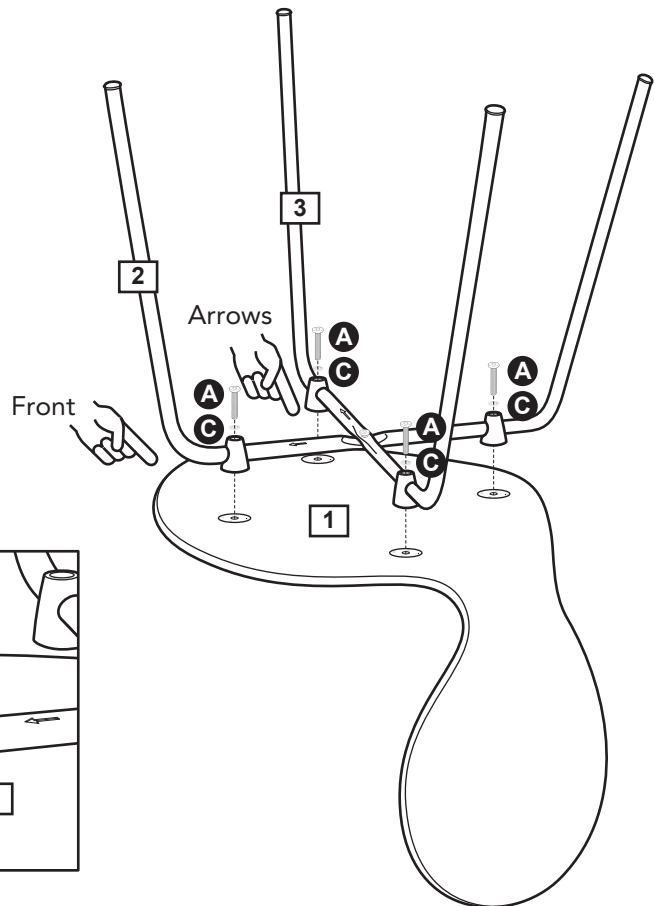
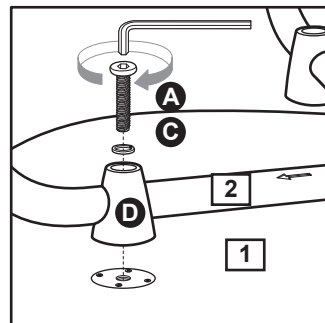

## Step 3

### Attaching small footings

Insert small footings **F** on the ends of the leg holder **D** as shown. Press firmly to secure.

**IMPORTANT NOTE:**  
Fasten bolts using allen key **G** and fully tighten bolts **A** and also bolt **B** assembled in step 3.

Carefully turn over the chair and place on a firm surface.

**Assembly is complete.**

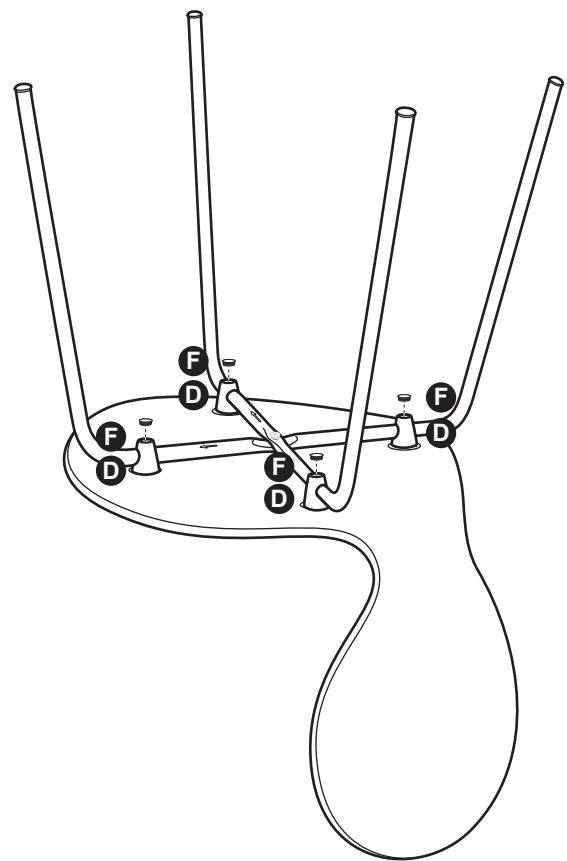
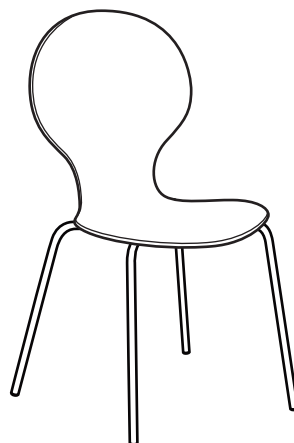
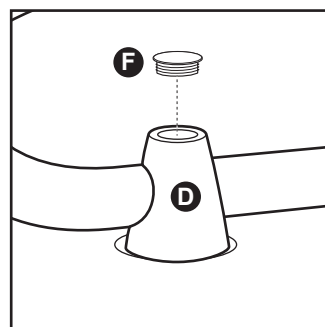

If you need help or have damaged or missing parts, call the **Customer Helpline:**  
**Argos = 0345 640 0800**