



Russell Hobbs



24520

 www.russellhobbs.com

£10,000 prize draw
EXTRA year guarantee FREE rewards gallery

www.russellhobbs.co.uk/productregister/ Register online now! See back for details

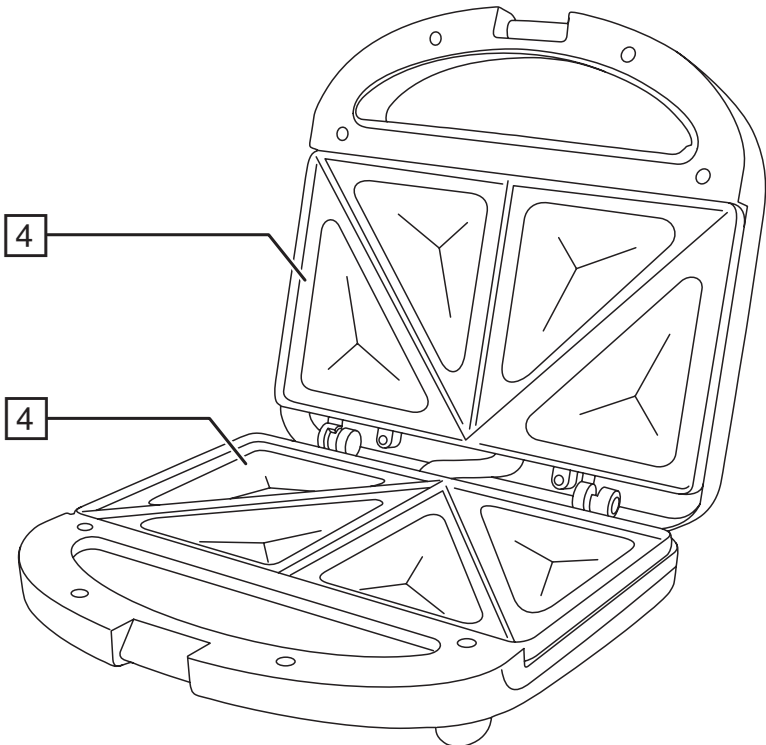
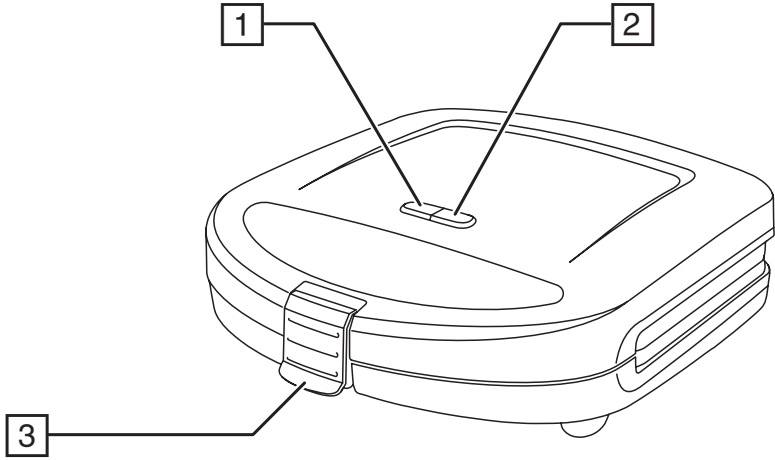

Read the instructions, keep them safe, pass them on if you pass the grill on.
Remove all packaging before use.

IMPORTANT SAFEGUARDS

Follow basic safety precautions, including:

This appliance can be used by children aged from 8 years and above and persons with reduced physical, sensory or mental capabilities or lack of experience and knowledge if they have been supervised/instructed and understand the hazards involved. Children shall not play with the appliance. Cleaning and user maintenance shall not be done by children unless they are older than 8 and supervised.

Keep the appliance and cable out of reach of children under 8.

Always allow adequate air space above and on all sides for air circulation.

Never use the appliance under cupboards or curtains or other flammable materials.

This appliance must not be operated by an external timer or remote control system.

 The surfaces of the appliance will get hot during use.

If the cable is damaged, return the appliance, to avoid hazard.

-  Do not use this appliance near bathtubs, showers, basins or other vessels containing water.
- Don't wrap food in plastic film, polythene bags, or metal foil. You'll damage the grill and you may cause a fire hazard.
- Don't use the grill for any purpose other than cooking food.
- Don't use the grill if it's damaged or malfunctions.
- Route the cable so it doesn't overhang, and can't be tripped over or caught.

HOUSEHOLD USE ONLY

PARTS

- | | |
|------------------------|--------------------|
| 1. Power light (red) | 3. Latch |
| 2. Ready light (green) | 4. Toasting plates |

BEFORE USING FOR THE FIRST TIME

Wipe the non-stick surfaces of the toasting plates with a damp cloth.

PREPARATION

1. Sit the sandwich toaster on a stable, level, heatproof (not just heat-resistant) surface.
2. Put the plug into the power socket (switch the socket on, if it's switchable).
3. The red power light will come on as long as the sandwich toaster is connected to the electricity supply.
4. The green ready light will come on when the elements reach the correct cooking temperature, then cycle on and off with the thermostat.
5. Wait till the green light comes on before starting to cook.

MAKING TOASTIES

CAUTION Don't use raw meat of any kind in the sandwich toaster. All fillings must be safe and fit to eat before cooking.

1. Use a level dessertspoon of filling per toastie. Too much will ooze out.
2. Cut 4 slices of bread to overlap the plates by about 0.5cm (¼ inch) all round. Fresh medium-sliced bread is best.
3. Spread butter/margarine thinly on each slice. Don't use low fat spread. Low fat spreads may burn, damaging the non-stick surfaces.
4. Toasties are made **buttered side out**. Put 2 slices of bread, buttered side down, on the bottom toasting plate.
5. Press the bread gently into the hollows in the toasting plate with a wooden spoon.
6. Fill the hollows formed in the bread with the filling.
7. Lay a slice of bread, buttered side up, on top of each of the filled slices.
8. Close the lid, squeeze the handles together, and press in the latch.
9. Cook for 4-5 minutes, or till the outside of the bread turns golden brown.
10. If the toasties stick, use a plastic or wooden spatula to release them.

CARE AND MAINTENANCE

1. Unplug the sandwich toaster and let it cool before cleaning and storing away.
2. Wipe the toasting plates, and the external surfaces with a damp cloth.
3. Use a paper towel with a dab of cooking oil to remove stubborn stains.
4. Don't put the sandwich toaster in water or any other liquid.
5. Don't use harsh or abrasive cleaning agents or solvents.
6. Don't use scourers, wire wool, or soap pads.

At the places where the top and bottom toasting plates make contact, the non-stick surfaces may show signs of wear. This is purely cosmetic, and will not affect the operation of the sandwich toaster.

SAVOURY FILLING IDEAS

Ham and pineapple

Ham and mushroom

Ham, cheese and tomato

Smoked ham and gouda

Cheese and onion/celery/apple

Salami and tomato

Chicken (cooked) and ham/mushroom

Bacon (cooked), lettuce and tomato

SWEET FILLING IDEAS

Apple and sultanas/raspberries

Apple and cinnamon

Apple and blackcurrant

Banana and honey

Banana and butterscotch sauce

Fruits of the forest

Date, walnut and honey

Cherry and almonds

VARIATIONS

Use pastry, pizza base, or ciabatta instead of ordinary bread; try fruit loaf with a sweet filling; try garlic or herb butter.

RECYCLING



To avoid environmental and health problems due to hazardous substances, appliances and rechargeable and non-rechargeable batteries marked with one of these symbols must not be disposed of with unsorted municipal waste. Always dispose of electrical and electronic products and, where applicable, rechargeable and non-rechargeable batteries, at an appropriate official recycling/collection point.

SERVICE

If you ring Customer Service, please have the model number to hand, as we won't be able to help you without it. It's on the rating plate (usually underneath the product).

The product isn't user-serviceable. If it's not working, read the instructions, check the plug fuse and main fuse/circuit breaker. If it's still not working, consult your retailer.

If that doesn't solve the problem – ring Customer Service – they may be able to offer technical advice.

If they advise you to return the product to us, pack it carefully, include a note with your name, address, day phone number, and what's wrong. If under guarantee, say where and when purchased, and include proof of purchase (till receipt). Send it to:

Customer Service
Spectrum Brands (UK) Ltd
Fir Street, Failsworth, Manchester M35 0HS
email: support@russellhobbs.com
telephone: 0345 658 9700 (local rate number)

GUARANTEE

Defects affecting product functionality appearing within two years of first retail purchase will be corrected by replacement or repair provided the product is used and maintained in accordance with the instructions. Your statutory rights are not affected. Documentation, packaging, and product specifications may change without notice.

ONLINE

www.russellhobbs.com for more products

REGISTER ONLINE FOR –

 £10,000 prize draw,
 EXTRA year guarantee,
 FREE rewards gallery
Visit www.russellhobbs.co.uk/productregister/
You must register within 28 days of purchase.