



MANUALE D'ISTRUZIONI

FORNO _____ IT **02**

USER INSTRUCTIONS

OVENS _____ EN **16**

NOTICE D'EMPLOI ET D'INSTALLATION

DES FOURS ENCASTRABLES _____ FR **30**

INSTRUCCIONES DE USO

HORNOS EMPOTRABLES _____ ES **45**

Safety Indications

- **WARNING:** the appliance and accessible parts become hot during use. Be careful not to touch any hot parts.
- **WARNING:** the accessible parts can become hot when the grill is in use. Children should be kept at a safe distance.
- **WARNING:** ensure that the appliance is switched off before replacing the bulb, to avoid the possibility of electric shocks.
- **WARNING:** in order to avoid any danger caused by the accidental resetting of the thermal interruption device, the appliance should not be powered by an external switching device, such as a timer, or be connected to a circuit that is regularly switched on and off.
- **WARNING:** before initiating the automatic cleaning cycle:
 - clean the oven door;
 - remove large or coarse food residues from the inside of the oven using a damp sponge. Do not use detergents;
 - remove all accessories and the sliding rack kit (where present);
 - do not place tea towels.
- Children under 8 should be kept at a safe distance from the appliance if not continuously supervised.
- Children should not play with the appliance. The appliance can be used by those aged 8 or over and by those with limited physical, sensorial or mental capacities, without experience or knowledge of the product, only if supervised or provided with instruction as to the operation of the appliance, in a safe way with awareness of the possible risks.
- Cleaning and maintenance should not be carried out by unsupervised children.
- Do not use rough or abrasive materials or sharp metal scrapers to clean the oven door glasses, as they can scratch the surface and cause the glass to shatter.
- The oven must be switched off before removing the removable parts and, after cleaning, reassemble them according the instructions.
- Only use the meat probe recommended for this oven.

- Do not use a steam cleaner.
 - Put the plug into a socket equipped with a third contact which corresponds to the earth and which must be connected and in operation. For models without a plug, attach a standard plug to the cable that is able to bear the load indicated on the tag. The earth conductor is yellow-green in colour. This operation should be carried out by a suitably qualified professional. In case of incompatibility between the socket and the appliance plug, ask a qualified electrician to substitute the socket with another suitable type. Connection to the power source can also be made by placing an omnipolar breaker between the appliance and the power source that can bear the maximum connected load and that is in line with current legislation. The yellow-green earth cable should not be interrupted by the breaker. The socket or omnipolar breaker used for the connection should be easily accessible when the appliance is installed.
 - If the power cable is damaged, it should be substituted with a cable or special bundle available from the manufacturer or by contacting the customer service department.
- If the cable is damaged, replace it promptly in accordance with the following instructions:
- open the cover of the terminal block;
 - remove the power cable and substitute it with a similar cable which is compatible with the appliance (type H05RR-F, H05V2V2-F).
 - This operation should be carried out by a suitably qualified professional. The earth conductor (yellow-green) must be approximately 10 mm longer than the other conductors. For any repairs, refer only to the Customer Care Department and request the use of original spare parts.
 - Failure to comply with the above can compromise the safety of the appliance and invalidate the guarantee.
 - Any excess of spilled material should be removed before cleaning.
 - During the pyrolytic cleaning process, surfaces can heat up more than usual, children should therefore be kept at a safe distance.

General Instructions

19

- 1.1 Safety indications
- 1.2 Electrical safety
- 1.3 Recommendations
- 1.4 Installation
- 1.5 Waste management
- 1.6 Conformity declaration

Product Description

21

- 2.1 Overview
- 2.2 Accessories
- 2.3 First use

Use of the Oven

22

- 3.1 Display description
- 3.2 Cooking modes

Oven Cleaning and Maintenance

25

- 4.1 General notes on cleaning
- 4.2 Pyrolysis
- 4.3 Aquactiva Function
- 4.4 Maintenance
 - Removal and cleaning of grills
 - Removal of the oven window
 - Removal and cleaning of the glass door
 - Changing the bulb

Troubleshooting

29

- 5.1 F.A.Q.

1. General Instructions

We thank you for choosing one of our products. For the best results with your oven, you should read this manual carefully and retain it for future reference. Before installing the oven, take note of the serial number so that you can give it to customer service staff if any repairs are required. Having removed the oven from its packaging, check that it has not been damaged during transportation. If you have doubts, do not use the oven and refer to a qualified technician for advice. Keep all of the packaging material (plastic bags, polystyrene, nails) out of the reach of children. When the oven is switched on for the first time, strong smelling smoke can develop, which is caused by the glue on the insulation panels surrounding the oven heating for the first time. This is absolutely normal and, if it occurs, you should wait for the smoke to dissipate before putting food in the oven. The manufacturer accepts no responsibility in cases where the instructions contained in this document are not observed.



NOTE: the oven functions, properties and accessories cited in this manual will vary, depending on the model you have purchased.

1.1 Safety Indications

Only use the oven for its intended purpose, that is only for the cooking of foods; any other use, for example as a heat source, is considered improper and therefore dangerous. The manufacturer cannot be held responsible for any damage resulting from improper, incorrect or unreasonable usage.

The use of any electrical appliance implies the observance of some fundamental rules:

- do not pull on the power cable to disconnect the plug from the socket;
- do not touch the appliance with wet or damp hands or feet;
- in general the use of adaptors, multiple sockets and extension cables is not recommended;
- in case of malfunction and/or poor operation, switch off the appliance and do not tamper with it.

1.2 Electrical Safety

ENSURE THAT AN ELECTRICIAN OR QUALIFIED TECHNICIAN MAKES THE ELECTRICAL CONNECTIONS.

The power supply to which the oven is connected must conform with the laws in force in the country of installation. The manufacturer accepts no responsibility for any damage caused by the failure to observe these instructions. The oven must be connected to an electrical supply with an earthed wall outlet or a disconnecter with multiple poles, depending on the laws in force in the country of installation. The electrical supply should be protected with suitable fuses and the cables used must have a transverse section that can ensure correct supply to the oven.

CONNECTION

The oven is supplied with a power cable that should only be connected to an electrical supply with 220-240 Vac 50 Hz power between the phases or between the phase and neutral. Before the oven is connected to the electrical supply, it is important to check:

- power voltage indicated on the gauge;
- the setting of the disconnecter.

The grounding wire connected to the oven's earth terminal must be connected to the earth terminal of the power supply.

WARNING

Before connecting the oven to the power supply, ask a qualified electrician to check the continuity of the power supply's earth terminal. The manufacturer accepts no responsibility for any accidents or other problems caused by failure to connect the oven to the earth terminal or by an earth connection that has defective continuity.

NOTE: as the oven could require maintenance work, it is advisable to keep another wall socket available so that the oven can be connected to this if it is removed from the space in which it is installed. The power cable must only be substituted by technical service staff or by technicians with equivalent qualifications.

1.3 Recommendations

After each use of the oven, a minimum of cleaning will help keep the oven perfectly clean.

Do not line the oven walls with aluminium foil or single-use protection available from stores. Aluminium foil or any other protection, in direct contact with the hot enamel, risks melting and deteriorating the enamel of the insides. In order to prevent excessive dirtying of your oven and the resulting strong smokey smells, we recommend not using the oven at very high temperature. It is better to extend the cooking time and lower the temperature a little. In addition to the accessories supplied with the oven, we advise you only use dishes and baking moulds resistant to very high temperatures.

1.4 Installation

The manufacturers have no obligation to carry this out. If the assistance of the manufacturer is required to rectify faults arising from incorrect installation, this assistance is not covered by the guarantee. The installation instructions for professionally qualified personnel must be followed. Incorrect installation may cause harm or injury to people, animals or belongings. The manufacturer cannot be held responsible for such harm or injury.

The kitchen unit in which the oven is to be fitted must be made of material resistant to temperatures of at least 70°C.

The oven can be located high in a column or under a worktop. Before fixing, you must ensure good ventilation in the oven space to allow proper circulation of the fresh air required for cooling and protecting the internal parts. Make the openings specified on last page according to the type of fitting.

1.5 Waste management and environmental protection



This appliance is labelled in accordance with European Directive 2012/19/EU regarding electric and electronic appliances (WEEE). The WEEE contain both polluting substances (that can have a negative effect on the environment) and base elements (that can be reused). It is important that the WEEE undergo specific treatments to correctly remove and dispose of the pollutants and recover all the materials. Individuals can play an important role in ensuring that the WEEE do not become an environmental problem; it is essential to follow a few basic rules:

- the WEEE should not be treated as domestic waste;
- the WEEE should be taken to dedicated collection areas managed by the town council or a registered company.

In many countries, domestic collections may be available for large WEEEs. When you buy a new appliance, the old one can be returned to the vendor who must accept it free of charge as a one-off, as long as the appliance is of an equivalent type and has the same functions as the purchased appliance.

SAVING AND RESPECTING THE ENVIRONMENT

Where possible, avoid pre-heating the oven and always try to fill it. Open the oven door as infrequently as possible, because heat from the cavity disperses every time it is opened. For a significant energy saving, switch off the oven between 5 and 10 minutes before the planned end of the cooking time, and use the residual heat that the oven continues to generate. Keep the seals clean and in order, to avoid any heat dispersal outside of the cavity. If you have an electric contract with an hourly tariff, the "delayed cooking" programme makes energy saving more simple, moving the cooking process to start at the reduced tariff time slot.

1.6 Declaration of compliance

The parts of this appliance that may come into contact with foodstuffs comply with the provisions of EEC Directive 89/109.

By placing the **CE** mark on this product, we are confirming compliance to all relevant European safety, health and environmental requirements which are applicable in legislation for this product.

2. Product Description

2.1 Overview



1. Control panel
2. Shelf positions
(lateral wire grid if included)
3. Metal grill
4. Drip pan
5. Fan (behind the steel plate)
6. Oven door

2.2 Accessories

1 Metal grill

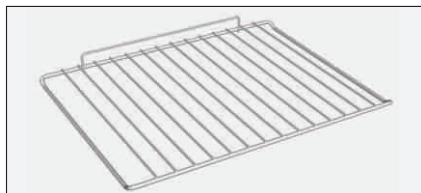

Holds baking trays and plates.

2 Drip pan



Collects the residues that drip during the cooking of foods on the grills.

2.3 First Use

PRELIMINARY CLEANING

Clean the oven before using for the first time. Wipe over external surfaces with a damp soft cloth. Wash all accessories and wipe inside the oven with a solution of hot water and washing up liquid. Set the empty oven to the maximum temperature and leave on for about 1 hour, this will remove any lingering smells of newness.

3. Use of the Oven

3.1 Display description









1. Timer/automatic mode
2. Fan function
3. Defrost mode
4. Temperature or clock display
5. LCD display adjustment controls
6. Function selector knob
7. Programme selector knob

WARNING!











The first operation to carry out after installation, or after a power cut, is to set the time of day (a power cut has occurred if the display is flashing 12:00).

200°-> The temperature LED "oo" flashes until the displayed temperature is reached.

HOT -> When a programme finishes, if the oven is still hot, the display shows "HOT", alternating with the time, even if the knobs are positioned to OFF.

FUNCTION	HOW TO ACTIVATE	HOW TO DEACTIVATE	WHAT IT DOES	WHY IT IS NEEDED
SILENCE MODE 	<ul style="list-style-type: none"> • Rotate the left function selector to the position "Silence mode " 	<ul style="list-style-type: none"> • Rotate the function selector to the position OFF. 	<ul style="list-style-type: none"> • Enables you to turn off the sound of the minute minder. 	<ul style="list-style-type: none"> • To turn off the sound of the minute minder
SET THE TIME 	<ul style="list-style-type: none"> • Rotate the left function selector to the position "Set the time". • Use the buttons " + " or " - " to set the time 	<ul style="list-style-type: none"> • Rotate the function selector to the position OFF. 	<ul style="list-style-type: none"> • Enables you to set the time which appears on the display 	<ul style="list-style-type: none"> • To set the time NB : Set the time when you first install your oven or just after a black out (the clock is showing a pulsating 12.00)
COOKING DURATION 	<ul style="list-style-type: none"> • Turn the right function selector to a cooking function • Rotate the left function selector to the position "Cooking Time Duration" • Set the time of cooking by using buttons " + " and " - " • Lighting Auto appears 	<ul style="list-style-type: none"> •When the cooking time has elapsed, the oven switch off automatically and the alarm rings for few seconds To stop the cooking functions early, turn the function control to OFF or set the time on 00.00; by rotating the function selector to Cooking Time Duration and by using the buttons " + " and " - " 	<ul style="list-style-type: none"> • It allows to preset the cooking time required for the recipe chosen. • When the cooking time is set, turn the function selector to OFF to go back to actual time. • To view the cooking time selected, turn the left function selector to Cooking Time duration. 	<ul style="list-style-type: none"> • For cooking the desired recipes.
END OF COOKING 	<ul style="list-style-type: none"> • Turn the right function selector to a cooking function • Rotate the left function selector to the position "End of cooking" • Set the end time of cooking by using buttons " + " and " - " • Lighting Auto appears 	<ul style="list-style-type: none"> • When the cooking time has elapsed, the oven switch off automatically. • To stop the cooking functions early, turn the function control to OFF 	<ul style="list-style-type: none"> • It allows to preset the end of cooking time you want. • When the cooking time is set, turn the function selector to OFF to go back to actual time. • To view the cooking time selected, turn the left function selector to End of cooking Time 	<ul style="list-style-type: none"> •This function is normally used with the COOKING DURATION function •For example, the desired food needs to cook for 45 minutes and I want it to be ready for 12.30; in this case: at the end of the set time, the oven automatically switches off and an alarm sounds. Select the desired cooking function. Set the cooking duration to 45 minutes ("." "+"). Set the end of cooking to 12:30 ("." "+"). Cooking will automatically begin at 11:45 (12:30 minus 45 minutes), at the end of the set cooking time, the oven will automatically switch off. WARNING: by setting only the end of cooking time, and not the cooking duration, the oven will immediately switch on and switch off at the end of the set cooking time.
MINUTE MINDER 	<ul style="list-style-type: none"> • Turn the left function selector to the position Minute Minder. • Set the time of cooking by using buttons " + " and " - " 	<ul style="list-style-type: none"> • Set the time on 00.00 by turning the left function selector to the position Minute Minder, and using the button " - " 	<ul style="list-style-type: none"> •Emits an audible signal at the end of a set time. •During operation, the display shows the remaining time. 	<ul style="list-style-type: none"> • Allow to use the oven as alarm even if the oven is switch off
CHILD SAFETY LOCK 	<ul style="list-style-type: none"> • Turn the left function selector to the position Child lock. • Press the button " + " during 5 seconds • Child lock is available when " STOP " appears on display 	<ul style="list-style-type: none"> • Turn back the left function selector to Child lock and press button " + " during 5 seconds. • Indication STOP disappears. 	<ul style="list-style-type: none"> • The oven cannot be used. 	<ul style="list-style-type: none"> • This function is useful when there are children in the house.

3.2 Cooking Modes

Function Dial	T °C default	T °C range	Function (Depens on the oven model)
			LAMP: Turns on the oven light.
	40	40 ÷ 40	DEFROST: When the dial is set to this position. The fan circulates air at room temperature around the frozen food so that it defrosts in a few minutes without the protein content of the food being changed or altered.
	210	50 ÷ 240	KEEP WARM: This is recommended to reheat precooked foodstuff, positioning the shelf on the second level from top, or to defrost bread pizza or pastry by positioning the shelf on the lower level. The temperature is preset in 60°C constant, no regulation is possible.
	180	50 ÷ 240	FAN COOKING: We recommend you use this method for poultry, pastries, fish and vegetables. Heat penetrates into the food better and both the cooking and preheating times are reduced. You can cook different foods at the same time with or without the same preparation in one or more positions. This cooking method gives even heat distribution and the smells are not mixed. Allow about ten minutes extra when cooking foods at the same time.
	210	50 ÷ 240	
* 	220	50 ÷ 280	CONVENTIONAL COOKING: Both top and bottom heating elements are used. Preheat the oven for about ten minutes. This method is ideal for all traditional roasting and baking. For seizing red meats, roast beef, leg of lamb, game, bread, foil wrapped food (papillotes), flaky pastry. Place the food and its dish on a shelf in mid position.
	210	50 ÷ 230	FAN + LOWER ELEMENT: The bottom heating element is used with the fan circulating the air inside the oven. This method is ideal for juicy fruit flans, tarts, quiches and pâté. It prevents food from drying and encourages rising in cakes, bread dough and other bottom-cooked food. Place the shelf in the bottom position.
** 	200	150 ÷ 220	FAN ASSISTED GRILL: use the turbo-grill with the door closed. The top heating element is used with the fan circulating the air inside the oven. Preheating is necessary for red meats but not for white meats. Ideal for cooking thick food items, whole pieces such as roast pork, poultry, etc. Place the food to be grilled directly on the shelf centrally, at the middle level. Slide the drip tray under the shelf to collect the juices. Make sure that the food is not too close to the grill. Turn the food over halfway through cooking.
	L3	L1 ÷ L5	GRILL: use the grill with the door closed. The top heating element is used alone and you can adjust the temperature. Five minutes preheating is required to get the elements red-hot. Success is guaranteed for grills, kebabs and gratin dishes. White meats should be put at a distance from the grill; the cooking time is longer, but the meat will be tastier. You can put red meats and fish fillets on the shelf with the drip tray underneath. The oven has two grill positions: Grill: 2140 W Barbecue: 3340 W
	L3	L1 ÷ L5	SUPER GRILL: the oven has two grill positions Grill: 2200 W Grill Super: 3000 W
	ECO	ECO÷SUPER	PYROLYSIS

*Tested in accordance with the CENELEC EN 60350-1

**Tested in accordance with the CENELEC EN 60350-1 used for definition of energy class.

4. Oven cleaning and maintenance

4.1 General notes on cleaning

The lifecycle of the appliance can be extended through regular cleaning. Wait for the oven to cool before carrying out manual cleaning operations. Never use abrasive detergents, steel wool or sharp objects for cleaning, so as to not irreparably damage the enamelled parts. Use only water, soap or bleach-based detergents (ammonia).

GLASS PARTS

It is advisable to clean the glass window with absorbent kitchen towel after every use of the oven. To remove more obstinate stains, you can use a detergent-soaked sponge, well wrung out, and then rinse with water.

OVEN WINDOW SEAL

If dirty, the seal can be cleaned with a slightly damp sponge.

ACCESSORIES

Clean accessories with a wet, soapy sponge before rinsing and drying them: avoid using abrasive detergents.

DRIP PAN

After using the grill, remove the pan from the oven. Pour the hot fat into a container and wash the pan in hot water, using a sponge and washing-up liquid.

If greasy residues remain, immerse the pan in water and detergent. Alternatively, you can wash the pan in the dishwasher or use a commercial oven detergent. Never put a dirty pan back into the oven.

4.2 Pyrolysis

The oven is equipped with a pyrolyser cleaning system, which destroys food residues at high temperature. The operation is carried out automatically by means of the programmer. The resulting fumes are rendered “clean” by passing over a Pyrolyser wick starts as soon as cooking begins. As very high temperatures are required by the Pyrolyser, the oven door is fitted with a safety lock. The pyrolyser can be stopped at any time. The door cannot be opened until the safety lock is displayed.

NOTE : If a hob has been fitted above the oven, never use the gas burners or the electric hot-plates while the Pyrolyser is working, this will prevent the hob from overheating.

TWO PYROLYTIC CYCLE are pre-set:

ECO PYROCLEAN : Cleans a moderately stained oven. Operates for a period of 65 minutes.

SUPER PYROCLEAN : Cleans a heavily stained oven. Operates for a period of 90 minutes.

Never use commercially available cleaning products on a Pyrolytic oven!

Tip : Carrying out Pyrolytic cleaning immediately after cooking allows you to take advantage of residual heat, thus saving energy.

Before executing a pyrolytic cycle:

• **Remove all the accessories from the oven because they are not able to tolerate the high temperatures used during the pyrolytic cleaning cycle ; in particular removing grids, side racks and the telescopic guides (refer to the chapter REMOVING GRIDS AND SIDE RACKS) . In ovens with meat probe it is necessary, before making the cleaning cycle , close the hole with the nut provided.**

• **Remove any large spillages or stains as it would take too long to destroy them. Also excessively large amounts of grease could ignite when subject to the very high temperatures of the Pyrolytic cycle.**

• **Close the oven door.**

• **Excess spillage must be removed before cleaning.**

• **Clean the oven door;**

• **Remove large or coarse food residues from the inside of the oven using a damp sponge. Do not use detergents;**

• **Remove all accessories and the sliding rack kit (where present);**

• **Do not place tea towels.**

Using the pyrolitic cycle:



1- Rotate the function selector to the position "  ". On the display, appears the indication " ECO " or " SUP ". The preset time is 65 min, this can be varied from 65 min (Eco mode) to 90 min (Sup mode) via the programmer (setting button " + " or " - "). If the oven is very dirty, it is recommended to increase the time to 90 min, if the oven is moderately dirty reduce the cleaning cycle time to 65 min.

2- It is possible to defer the start time of the pyroclean cycle by changing the END time via the programmer.

3- After few minutes, when the oven reaches a high temperature, the door locks automatically. The pyroclean cycle can be stopped at any time by turning the function selector back to '0' (the word OFF will be displayed for 3 seconds).

4 - Once the pyroclean cycle is finished, the pyrolysis will switch off automatically. On the display appears the indication "END" until the door is locked then "0--n".

5- You can turn the function selector back to " 0 " but if the temperature is still high, the "0--n " indication appears to inform that the door is locked.

Use of the pyrolytic cycle in Touch Control ovens:

1- Rotate the function selector into position pyrolysis. The display will show either "ECO" or "SUP"

2- The pre-set time is 65 minutes but it can be varied from 65 min. (Eco mode) to 90 min. (Sup mode) using the programmer (" + " or " - " key). If the oven is very dirty, the time should be increased to 90 min., while if the oven is only a slightly dirty, reduce the cleaning cycle to 65 min.

4.3 Aquactiva Function

The Aquactiva procedure uses steam to help remove remaining fat and food particles from the oven.

1. Pour 300 ml of water into the Aquactiva container at the bottom of the oven.

2. Set the oven function to Static () or Bottom () heater

3. Set the temperature to the Aquactiva icon 

4. Allow the program to operate for 30 minutes.

5. After 30 minutes switch off the program and allow the oven to cool down.

6. When the appliance is cool, clean the inner surfaces of the oven with a cloth.

Warning:

Make sure that the appliance is cool before you touch it.

Care must be taken with all hot surfaces as there is a risk of burns. Use distilled or drinkable water.

N.B.: Certain pyrolytic ovens with the Precò Touch User Interface offer the Aquactiva function. To activate it, set the function selector to the AQUACTIVA symbol () and set the oven temperature to 90°, using the " - " and " + " keys.



4.4 Maintenance

REMOVAL AND CLEANING OF THE SIDE RACKS

1. Unscrew the bolt in an anti-clockwise direction.
2. Remove the side racks by pulling them towards you.
3. Clean the side racks in a dishwasher or with a wet sponge and then dry them immediately.
4. Having cleaned the side racks, put them back in and reinsert the bolts, ensuring that they are fully tightened.

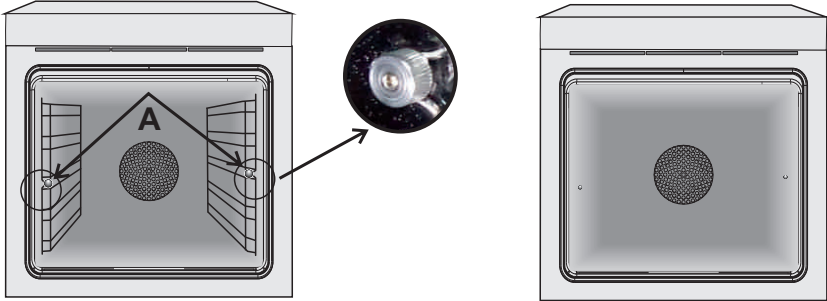

REMOVAL OF THE OVEN WINDOW

1. Open the front window.
2. Open the clamps of the hinge housing on the right and left side of the front window by pushing them downwards.
3. Replace the window by carrying out the procedure in reverse.

REMOVAL AND CLEANING OF THE GLASS DOOR

1. Open the oven door.

2.3.4. Lock the hinges, remove the screws and remove the upper metal cover by pulling it upwards.

5.6. Remove the glass, carefully extracting it from the oven door (NB: in pyrolytic ovens, also remove the second and third glass (if present)).

7. At the end of cleaning or substitution, reassemble the parts in reverse order.

On all glass, the indication "Pyro" must be legible and positioned on the left side of the door, close to the left-hand lateral hinge. In this way, the printed label of the first glass will be inside the door.

1.



5.

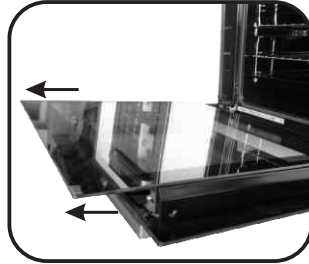

2.

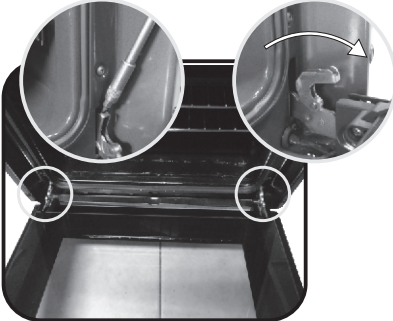

6.

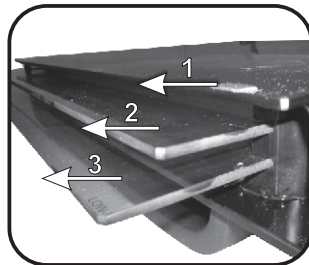

3.

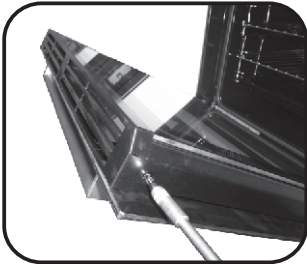

7.

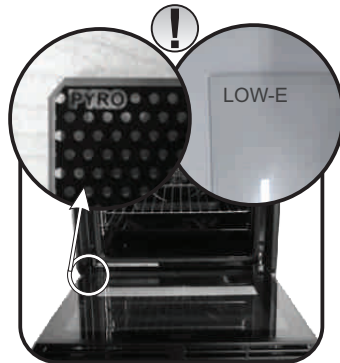

4.

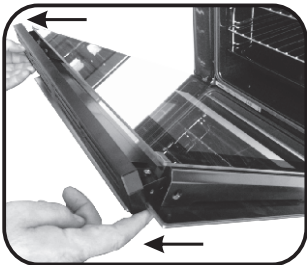

CHANGING THE BULB

1. Disconnect the oven from the mains supply.
2. Undo the glass cover, unscrew the bulb and replace it with a new bulb of the same type.
3. Once the defective bulb is replaced, replace the glass cover.

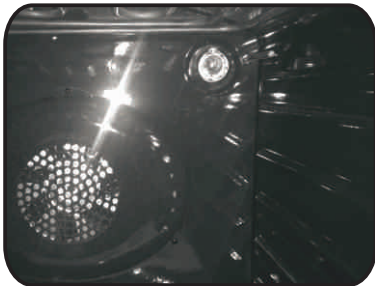

5. Troubleshooting

5.1 FAQ

PROBLEM	POSSIBLE CAUSE	SOLUTION
The oven does not heat up	The clock is not set	Set the clock
The oven does not heat up	The child lock is on	Deactivate the child lock
The oven does not heat up	A cooking function and temperature has not been set	Ensure that the necessary settings are correct

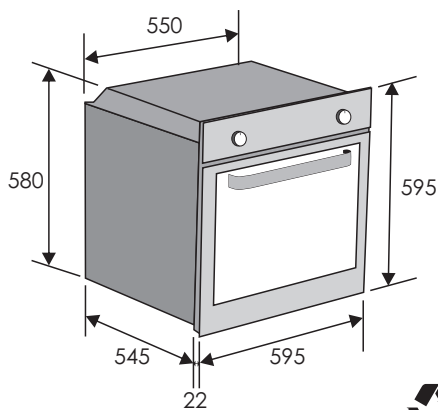
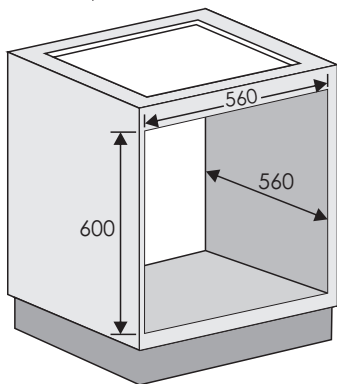
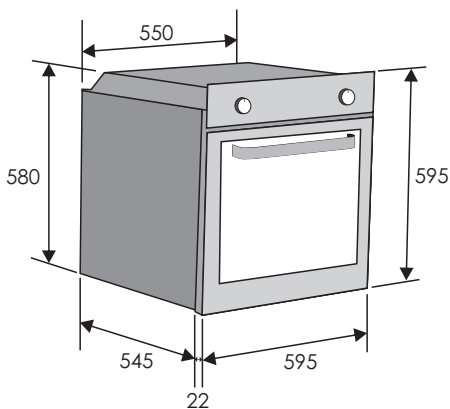
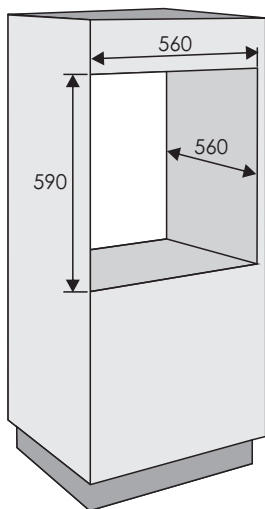
INSTALLAZIONE**IT****INSTALLATION****FR****INSTALLATION****GB****INSTALACIÓN****ES**

06.2016 • REV.D • 42818254

IT

La Ditta costruttrice declina ogni responsabilità per eventuali errori di stampa contenuti nel presente libretto. Si riserva inoltre il diritto di apportare le modifiche che si renderanno utili ai propri prodotti senza compromettere le caratteristiche essenziali.

GB

The manufacturer will not be responsible for any inaccuracy resulting from printing or transcript errors contained in this brochure. We reserve the right to carry out modifications to products as required, including the interests of consumption, without prejudice to the characteristics relating to safety or function.

FR

Le constructeur décline toute responsabilité concernant d'éventuelles inexactitudes imputables à des erreurs d'impression ou de transcription contenue dans cette notice. Le constructeur se réserve le droit de modifier les produits en cas de nécessité, même dans l'intérêt de l'utilisation, sans causer de préjudices aux caractéristiques de fonctionnement de sécurité des appareils.

ES

La empresa constructora declina toda responsabilidad derivada de eventuales errores de impresión contenidos en el presente libro. Se reserva además el derecho de realizar las modificaciones que se consideren útiles a los productos sin comprometer las características esenciales.