

challenge[®]

**Air Purifier
Instruction Manual
Model No.: KJ200G-D41**



READ AND SAVE THESE INSTRUCTIONS

CONTENTS

SAFETY WARNINGS	3
IDENTIFICATION OF PARTS	5
INSTALLATION	6
PLACEMENT	7
OPERATION	8
CARE AND MAINTENANCE	9
TECHNICAL INFORMATION	11
TROUBLESHOOTING	12
CONNECTION TO POWER	13

I Safety Warnings

- If the supply cord is damaged, it must be replaced by manufacturer, its service agent or a similarly qualified person in order to avoid a hazard.
- This appliance can be used by children aged from 8 years and above and persons with reduced physical, sensory or mental capabilities or lack of experience and knowledge if they have been given supervision or instruction concerning use of the appliance in a safe way and understand the hazards involved. Children shall not play with the appliance. Cleaning and user maintenance shall not be made by children without supervision.
- Prior to cleaning or other maintenance, the appliance must be disconnected from the supply mains.
- Children should be supervised to ensure that they do not play with the appliance.
- Do not install the appliance in a location that may be exposed to combustible gas.
- If combustible gas accumulates around the unit, it may cause fire.
- If the appliance is knocked over during use, turn off the unit and unplug it from the main power supply immediately. Visually inspect the unit to ensure there is no damage. If you suspect the unit has been damaged, contact a technician or customer service for assistance.
- In a thunderstorm, the power must be cut off to avoid damage to the machine due to lightning.
- Repair must be conducted by professionals
- When moving, cleaning or disassembling the purifier, stop operation and disconnect power supply
- Unauthorized replacement of power line is prohibited. If the power cord is damaged, replacement must be conducted by professionals of the manufacturer, maintenance department or similar departments to avoid risk.
- Do not operate with wet hands
- Do not press the control panel on the top of the machine forcibly
- Do not place articles on the top of the machine

- Do not insert foreign matters at air inlet and outlet
- If it is not used for a long time, please pull out the plug, put the machine back in the carton, and store it in the locker.
- It is forbidden to store flammable and explosive gas at the place where the purifier is used
- Avoid long-time direct sunlight
- It is forbidden to use the machine at places with heavy moisture and easy to be sprayed with water, such as the bathroom
- Do not use the machine in smoky environment, such as the kitchen.
- Do not use the machine outdoor
- This air purifier is intended for household use only and NOT for commercial or industrial use.
- Keep finger, hair and loose clothing away from moving parts and opening whist using the air purifier.
- Always position the air purifier on the flat ,stable solid surface and never over stretch the power cord.
- Position the air purifier where dirty air is not drawn across your body or head while sitting or sleeping.
- Inspecting the air purifier regularly and remove ant dust/dirt build up as this may affect the airflow
- Keep all opening/grills clear and free from obstruction and source of heat, open flames including candles. Don't attempt to remove blockages with sharp objects as this may cause damage to the air purifier.
- Turn off all controls on the air purifier before disconnecting or connecting the power cord
- Don't use the air purifier if it has been dropped, damaged or left outdoors
- Don't run the power cord under rugs, runners or carpets as it can be a trip hazard.
- Don't unplug the air purifier by pulling on the power cord

I Identification of parts

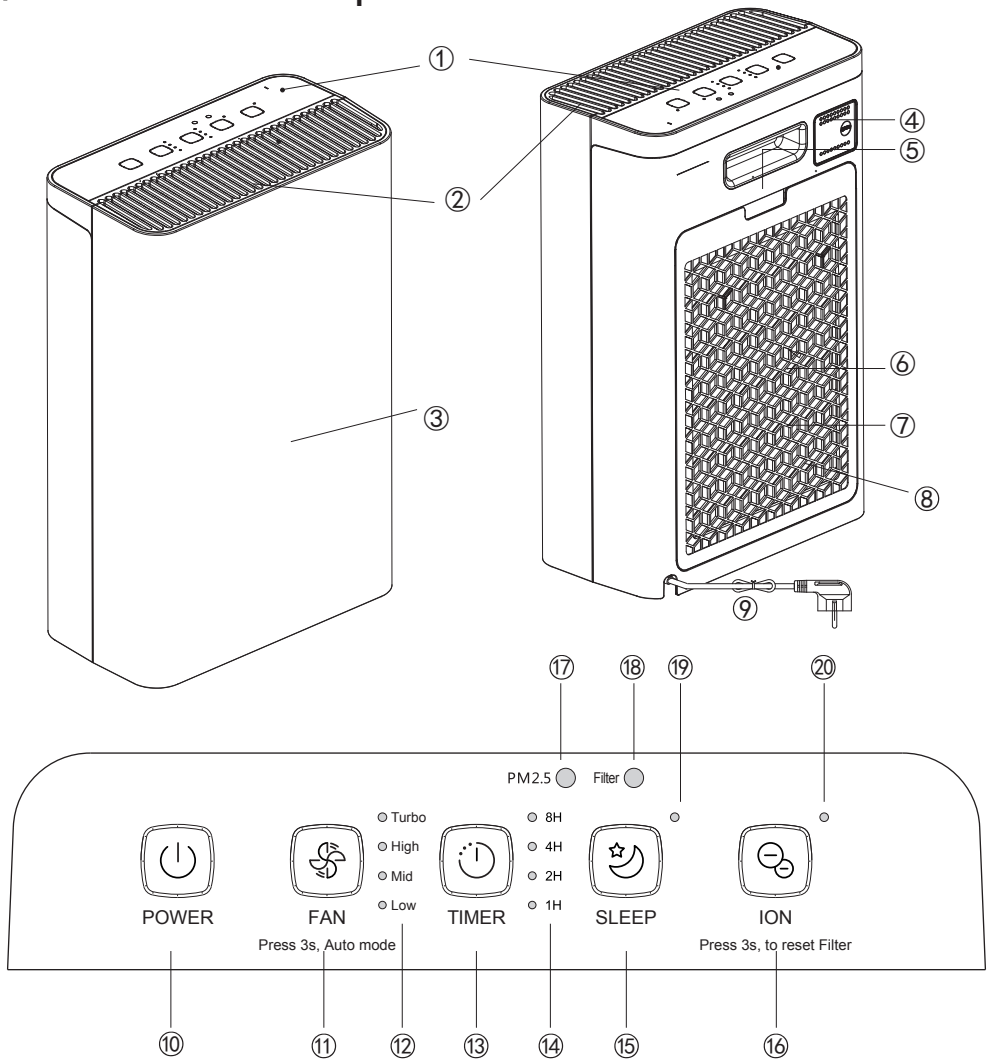

- | | |
|--|--------------------------|
| ① control panel | ⑪ fan button |
| ② air outlet | ⑫ fan indicator light |
| ③ front case | ⑬ timer button |
| ④ dust sensor | ⑭ timer indicator light |
| ⑤ handle | ⑮ sleep button |
| ⑥ air inlet | ⑯ ion button |
| ⑦ back cover | ⑰ air quality indicator |
| ⑧ 3 in 1 filter(installed in filter compartment) | ⑱ filter clean indicator |
| ⑨ power cord and plug | ⑲ sleep indicator light |
| ⑩ power button | ⑳ ion indicator light |

Installation

Filter installation - IMPORTANT

THE FILTER WAS PACKED INTO A POLYBAG BEFORE PACKING. IT IS A MUST TO TAKE OUT TO REMOVE THE POLYBAG BEFORE 1ST USE.

1. Open the back cover (see fig.1)

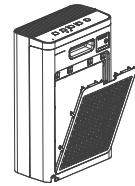

Fig.1

2. Remove the packed filter from machine. (see fig.2)

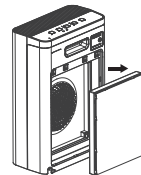

Fig.2

3. Take out the filter from polybag. (see fig.3)

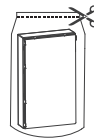

Fig.3

4. Install the filter to machine (see fig.4)

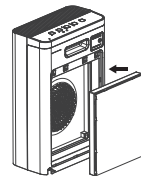

Fig.4

5. Replace the back cover (see fig.5)

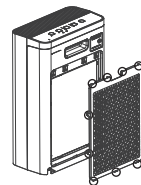

Fig.5

| Placement

When positioning the air purifier, ensure that it is placed on a level surface and that there is a minimum of 30cm of space on either side of the unit to allow for efficient airflow.

We do not recommend the use of an extension lead, so please try to ensure that the unit is sufficiently close to a fixed main socket. If it is necessary to use an extension lead, please ensure the diameter of the wires of the cable is at least 1 mm².

When the air purifier is in operation, outside doors and windows should be closed when necessary for most efficient use.

Make sure that there is no obstruction around the air inlet and the air outlet. The position of the air inlet and outlet is as below:

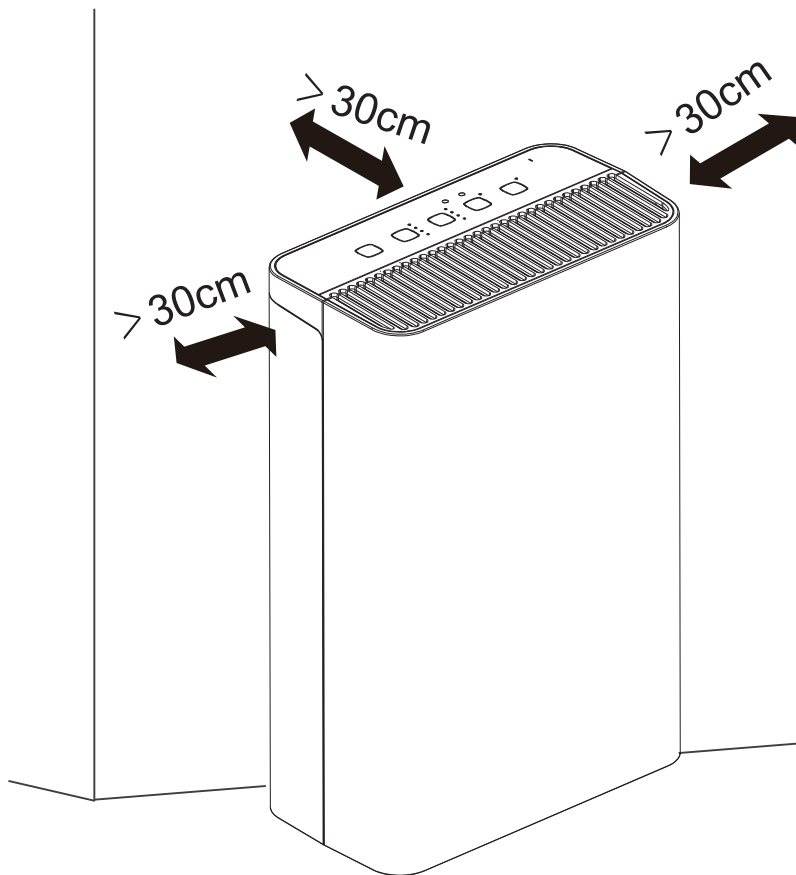

Operation

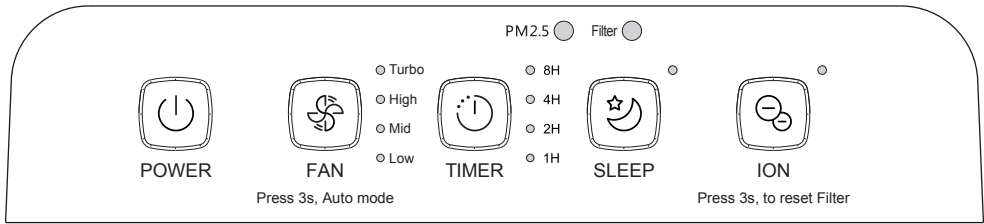

1. ON/OFF button

Press the button once to start the unit. Press it again to shut it down.



2. Fan button

Press the button to adjust fan speed. It will switch from Turbo – High – Mid – Low. The relevant indicator will be illuminated.

The air purification will be increased or decreased depending on the fan speed, i.e. when the fan speed is faster, the air purification will be higher.

Press and hold the button for 3 seconds, it will enter into auto mode. All 4 fan indicators will be illuminated. To exit the auto mode, press the button it will switch back to the previous mode.



3. Timer button

Continue to press the button to select the desired time (1H – 2H – 4H – 8H). Once the time has been selected, the relevant indicator will be illuminated. The unit will start to count down and once the set time is arrived, it will switch itself off.



4. Sleep button

Press the button once, the sleep indicator will be illuminated. The unit will switch to sleep mode. All the indicator light will switch off except the sleep indicator. Then the fan speed will be changed to low.

To cancel, press any button once and the unit will revert back to the normal operation.



5. Ion button

Press the button to open ion function. Press the button again the function will be closed.

6. Air quality indicator PM2.5

The purifier will detect the particles in the air through the dust sensor at the rear panel. It will illuminate in three different colour (Green, orange and Red).

PM2.5 is the term fine particles, or particulate matter 2.5 (PM2.5), refers to tiny particles or droplets in the air that are two and one half microns or less in diameter

Air quality (dust)	Color of air quality light
Good	Green
Normal	Orange
Bad	Red

How PM2.5 affect people's health: Particles in the PM2.5 size range are able to travel deeply into the respiratory tract, reaching the lungs. Exposure to fine particles can cause short-term health effects such as eye, nose, throat and lung irritation, coughing, sneezing, runny nose and shortness of breath. Exposure to fine particles can also affect lung function and worsen medical conditions such as asthma and heart disease.

7. Filter clean indicator Filter

If the Filter clean indicator is illuminated, the filter should be cleaning asap. Please refer to the Cleaning section for details. Once the clean of filter has been completed, please insert the filter back to the unit and press the Ion button for 3 seconds to reset the counter for filter. The indicator will be switched back to off.

Care and maintenance

Cleaning

Always unplug the unit from the power supply before beginning cleaning to avoid electric hazard.

Housing

Use a soft, damp cloth to wipe the cabinet clean. Never use strong chemicals, oil-based products, detergents, chemically treated cloths or other cleaning solution. These could damage the cabinet.

Filter cleaning

When filter cleaning indicator is illuminated, it is time to remove the filter for cleaning. Before cleaning, please unplug the unit from mains.

1. Open the rear cover to remove the filter. (see fig. 6)
2. Clean the filter with dist collect or hairbrush (not included). (see fig. 7)
3. Once it is completed, put the filter back to the unit. (see fig. 8)
4. Replace the back cover. (see fig. 9)
5. Connect to mains and press ON/OFF button to start.
6. Press Ion button for 3 seconds to reset the filter clean indicator.



Fig.6

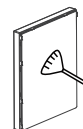

Fig.7

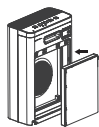

Fig.8

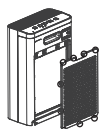

Fig.9

Special warning

- Do not wash the filter with water. This will damage the filter.
- When cleaning the filter screen, it is recommended to use small soft hairbrush or household dust collector;
- When cleaning with hairbrush, brush horizontally along with the filter screen, and avoid vertical brush as much as possible so as not to damage the filter screen;
- When cleaning with dust collector, keep the exhaust inlet 5-10mm away from surface of the filter screen so as not to damage the filter screen.

Recommandation

- It is suggested that the filter screen should be cleaned every two weeks and replaced every half a year (cleaning and replacement cycle may be adjusted according to the service environment);
- When being used under environments with strong smell such as smoke, barbecue, etc., the filter screen may have odor within several weeks or several months. If so, please clean and dry the filter screen (2-5 days). If the odor cannot be removed, please replace the filter screen.

Filter replacement

If you find the filter has been damaged and require to change. Please visit website www.argoosupport.co.uk to find out the spare part.

Dust sensor cleaning

The dust sensor should be clean regular, i.e. every 2 months. This can ensure the dust sensor operate in normal.

1. The dust sensor is located at the rear panel.
2. Press on the dust sensor cover to remove the cover. (see fig. 10)
3. Clean the sensor lens with wet cotton swab and then use dry cotton swab to wipe residual water stains on the lens.(see fig. 11)
4. Once the lens is completed dry, replace the cover and make sure it is locked in place.

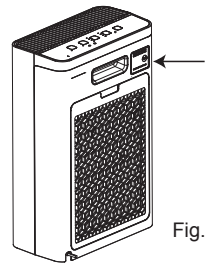

Fig.10

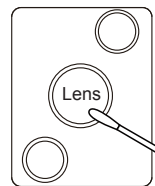

Fig.11

Technical information

Model	KJ200G-D41
Applying area (m ²)	20-24
Rated voltage (V~)	220-240
Rated frequency (Hz)	50
Rated power (W)	50
Noise [dB (A)]	35-60
Purification efficiency particles	Efficient level
Purification efficiency formaldehyde	Efficient level
Net Weight (kg)	5.7
Dimensions (mm) (length x width x height)	325x172x500

Solid Contaminants Clean Air Delivery Rate (CADR):

CADR(FT ³ /Min)	Test results
SMOKE	139
POLLEN	102
DUST	130

Due to product improvement, the following parameters may be changed, so it is subject to the product nameplate parameters.

Troubleshooting

Never try to repair or dismantle the appliance yourself. Incompetent repairs result in loss of warranty and can endanger the user and the property. If you have any question, please consult the qualified person.

Problems encountered	Reason	Solution
During continuous operation, the air quality indicator light is red all the time	<ul style="list-style-type: none"> - Room area may exceed purification capacity of the machine - Filter screen assembly may not be installed 	<ul style="list-style-type: none"> - Please keep the purifier operating continuously - Please install the filter screen assembly correctly
The purifier cannot operate	<ul style="list-style-type: none"> - Power line may not be inserted or power line has bad contact - Power switch may be not turned on 	<ul style="list-style-type: none"> - Please insert the power supply and make it contact well - Please turn on the power switch.
Poor smoke and odor removal effect	<ul style="list-style-type: none"> - Filter screen assembly may not be installed well - Service life of filter screen assembly is over - Air inlet may be blocked by foreign matter 	<ul style="list-style-type: none"> - Please install the filter screen assembly correctly - Please replace with new filter screen assembly - Please remove the foreign matter at air inlet
The air quality indicator light does not change.	<ul style="list-style-type: none"> - Sensitivity of sensor may be unstable within certain period after operating - If the light does no change after becoming green, the air may be in cleaning state - It may be placed at a place difficult to monitor dirt or the sensor is dirty - Sensitivity of the sensor declines due to strong odor indoor 	<ul style="list-style-type: none"> - Please wait. After operating for a few minutes, the sensor will tend to be stable - Blow smoke to the sensor. If the color of the indicator light changes, it is normal - Please move the purifier, or clean the sensor - please adjust the air speed to the high gear to run for several hours ~ 1 day.
Filter screen cleaning light is not off	<ul style="list-style-type: none"> - After filter screen assembly is cleaned, "ION" button is not pressed for 3 seconds 	<ul style="list-style-type: none"> - After filter screen assembly is cleaned, press "ION " button for 3 seconds
Odor and smoke are difficult to remove	<ul style="list-style-type: none"> - Filter screen assembly may still be packed in the package 	<ul style="list-style-type: none"> - Please remove the package outside the filter screen assembly

In case of circumstances below, please send the air purifier for repair:

1. The machine operates abnormally or fails to operate and the methods above are invalid;
2. External substance or water enters the machine and the machine operates abnormally.

Connection To Power

Before switching on make sure that the voltage of your electricity supply is the same as that indicated on the rating plate

MAIN CORD

This appliance may be fitted with a non-rewireable plug.

If it is necessary to change the fuse in a non-rewireable plug the fuse cover must be refitted. If the fuse cover is lost or damaged, the plug must not be used until a replacement is obtained.

It is important that the color of the replacement fuse cover corresponds with the colour marking on the base of the plug.

If the plug has to be changed because it is not suitable for your socket, or becomes damaged, it should be cut off and an appropriate plug fitted following the wiring instructions below.

The plug removed must be disposed of safely as insertion into a 13A socket is likely to cause an electrical hazard.

For your own safety read the following instructions carefully before attempting to connect this unit to mains.

The wires in this mains lead are coloured in accordance with the following code:

BLUE = NEUTRAL
BROWN = LIVE

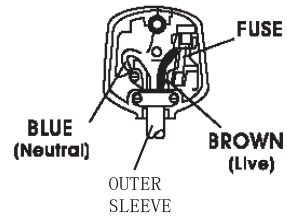

IMPORTANT

As the colours of the wire in the mains lead of this appliance may not correspond with the coloured markings identifying the terminals in your plug, proceed as following:-

The wire which is coloured blue must be connected to the terminal which is marked with the letter N or coloured black.
The wire which is coloured brown must be connected to the terminal which is marked with the letter L or coloured red.
No connection is to be made to the earth terminal of the plug.

If a 13 Amps (BS 1363) plug is used, it must be fitted with a 3 Amp Fuse conforming to BS1362 and be ASTA approved. If in doubt consult a qualified electrician who will be pleased to do this for you.

CORRECT DISPOSAL OF THIS PRODUCT



This marking indicates that this product should not be disposed with other household wastes throughout the EU. To prevent possible harm to the environment or human health from uncontrolled waste disposal, recycle it responsibly to promote the sustainable reuse of material resources. To return your used device, please use the return and collection systems or contact the retailer where the product was purchased. They can take this product for environmental safe recycling.



PRODUCT GUARANTEE

This product is guaranteed against manufacturing defects for a period of



Year

This product is guaranteed for twelve months from the date of original purchase.

Any defect that arises due to faulty materials or workmanship will either be replaced, refunded or repaired free of charge where possible during this period by the dealer from whom you purchased the unit.

The guarantee is subject to the following provisions:

- The guarantee does not cover accidental damage, misuse, cabinet parts, knobs or consumable items.
- The product must be correctly installed and operated in accordance with the instructions contained in this manual. A replacement copy of this instruction manual can be obtained from www.argos-support.co.uk
- It must be used solely for domestic purpose.
- The guarantee will be rendered invalid if the product is re-sold or has been damaged by inexpert repair.
- Specifications are subject to change without notice.
- The manufacturer disclaims any liability for the incidental or consequential damages.
- The guarantee is in addition to, and does not diminish your statutory or legal rights.

Guarantor: Argos Ltd
489 - 499 Avebury Boulevard
Central Milton Keynes
MK9 2NW

www.argos-support.co.uk