



**LEX85 XX X**  
**LECO85 XXX X**

**GB** English

## **Operating Instructions**

### **REFRIGERATOR/FREEZER COMBINATION**

#### **Contents**

Operating Instructions, 1  
Assistance, 2  
Description of the appliance, 3  
Reversible doors, 8  
Installation, 4  
Start-up and use, 5  
Maintenance and care, 6  
Precautions and tips, 6  
Troubleshooting, 7

# Product Guarantee and Repair Information

## Guarantee

### 12 Months Parts and Labour Guarantee

Your appliance has the benefit of our manufacturer's guarantee, which covers the cost of breakdown repairs for twelve months from the date of purchase.

This gives you the reassurance that if, within that time, your appliance is proven to be defective because of either workmanship or materials, we will, at our discretion, either repair or replace the appliance at no cost to you:

This guarantee is subject to the following conditions:

- The appliance has been installed and operated correctly and in accordance with our operating and maintenance instructions.
- The appliance is used only on the electricity or gas supply printed on the rating plate.
- The appliance has been used for normal domestic purposes only.
- The appliance has not been altered, serviced, maintained, dismantled, or otherwise interfered with by any person not authorised by us.
- Any repair work must be undertaken by us or our appointed agent.
- Any parts removed during repair work or any appliance that is replaced become our property.
- The appliance is used in the United Kingdom or Republic of Ireland.

The guarantee does not cover:

- Damage resulting from transportation, improper use, neglect or interference or as a result of improper installation.
- Replacement of any consumable item or accessory. These include but are not limited to: plugs, cables, batteries, light bulbs, fluorescent tubes and starters, covers and filters.
- Replacement of any removable parts made of glass or plastic.

THIS GUARANTEE WILL NOT APPLY IF THE APPLIANCE HAS BEEN USED IN COMMERCIAL OR NON-DOMESTIC PREMISES.

## Recycling and Disposal Information

As part of Hotpoint's continued commitment to helping the environment, Hotpoint reserves the right to use quality, recycled components to keep down customer costs and minimise material wastage.

Please dispose of packaging and old appliances carefully. To minimise the risk of injury to children, remove the door, plug, and cut the mains cable off flush with the appliance. Dispose of these parts separately to ensure that the appliance can no longer be plugged into mains socket, and the door cannot be locked shut.

## Repairs and After Sales

For product help and advice, repairs, spare parts or accessories, we're here to help.

For local repair engineers - **03448 111 606**  
ROI - **0818 313 413**

UK standard local rate applies  
ROI local Irish rate applies

For Parts and Accessories visit:  
**parts.hotpoint.co.uk/shop**

Please remember to register your appliance at **www.hotpointservice.co.uk** to activate your 10 year parts guarantee.

Please note, our advisors will require the following information: model number, serial number

**GB - model**

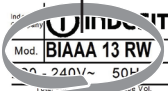

**GB - serial number**



Mod. <b>BIAAA 13 RW</b>		P.N. <b>34874470100</b>		S/N <b>000000000</b>	
Gross 334 l		Gross 0 l		Gross 116 l	
Brut 218 l		Brut 0 l		Brut 116 l	
Net 303 l		Net 0 l		Net 90 l	
Utilite 213 l		Utilite 0 l		Utilite 90 l	
Refr. 62 g		Freez. g		2,0 kg/24h	
Freez. g		87447		19512817900	

## Description of the appliance

### Overall view

The instructions contained in this manual are applicable to different model refrigerators. The diagrams may not directly represent the appliance purchased. For more complex features, consult the following pages.

- 1 Levelling **FEET**
- 2 **STORAGE** compartment\*
- 3 **FREEZER** and **STORAGE** compartment
- 4 **FRUIT** and **VEGETABLE** bin \*
- 5 **MULTI USE DRAWER** Container\*
- 6 **TEMPERATURE REGULATING** Knob
- 7 **WINE RACK** \*
- 8 **SHELVES** \*
- 9 **LAMP** (see Maintenance).
- 10 **AIR**\*
- 11 Extractable **STORAGE shelf WITH COVER** \*
- 12 Removable multipurpose **SHELVES** \*
- 13 **BOTTLE** shelf

\* Varies by number and/or position, available only on certain models.

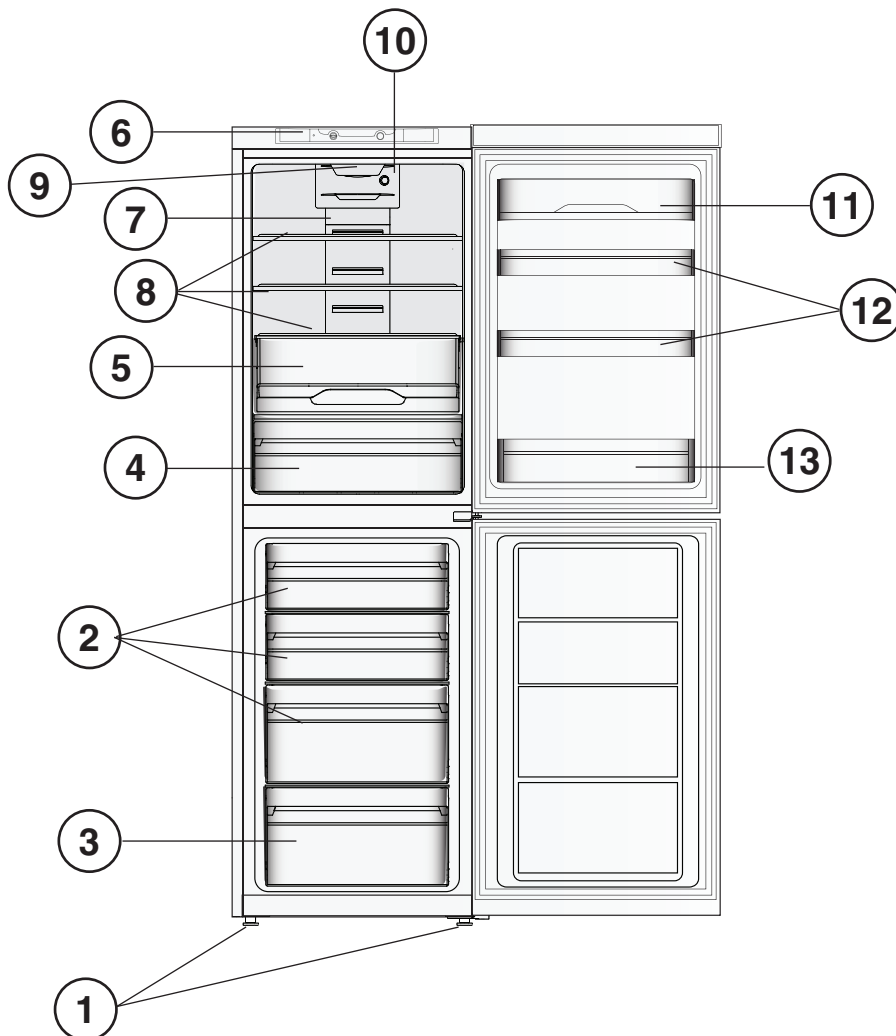

## Installation

! Before placing your new appliance into operation please read these operating instructions carefully. They contain important information for safe use, for installation and for care of the appliance.

! Please keep these operating instructions for future reference. Pass them on to possible new owners of the appliance.

### Positioning and connection

#### Positioning

1. Place the appliance in a well-ventilated humidity-free room.
2. Do not obstruct the rear fan grills. The compressor and condenser give off heat and require good ventilation to operate correctly and save energy.
3. Leave a space of at least 10 cm between the top part of the appliance and any furniture above it, and at least 5 cm between the sides and any furniture/side walls.
4. Place the device far from heat sources (direct sun light, electric kitchen etc.)

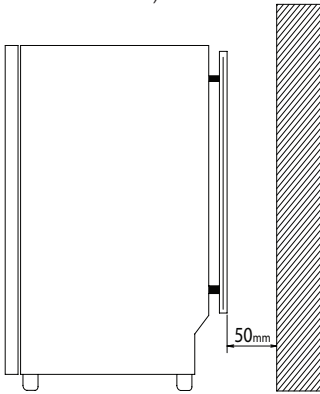

#### Levelling

1. Install the appliance on a level and rigid floor.
2. If the floor is not perfectly horizontal, adjust the refrigerator by tightening or loosening the front feet.

#### Electrical connections

After the appliance has been transported, carefully place it vertically and wait at least 3 hours before connecting it to the electricity mains. Before inserting the plug into the electrical socket ensure the following:

- The appliance is earthed and the plug is compliant with the law.
- The socket can withstand the maximum power of the appliance,
- The voltage must be in the range between the values indicated on the data plate located on the bottom left side (e.g. 220-240V).
- The socket is compatible with the plug of the appliance. If the socket is incompatible with the plug, ask an authorised technician to replace it (see Assistance). Do not use extension cords or multiple sockets.

! Once the appliance has been installed, the power supply cable and the electrical socket must be easily accessible.

! The cable must not be bent or compressed.

! The cable must be checked regularly and replaced by authorised technicians only (see Assistance).

**! The manufacturer declines any liability should these safety measures not be observed.**

## Start-up and use

### Starting the appliance

**! Before starting the appliance, follow the installation instructions (see Installation).**

! Before connecting the appliance, clean the compartments and accessories well with lukewarm water and bicarbonate.

! Electronic versions are provided with a motor protection switch that powers on the compressor only almost 8 minutes after the starting. The compressor also starts each time the power supply is cut off whether voluntarily or involuntarily (blackout).

1. Insert the plug into the socket and make sure that the inside light turns on.
2. Turn the knob to set the temperature on the range ❄️🌿 (ECO)  
After a few hours you can put food in the refrigerator

### Setting the temperature\*

❄️ = warmest

❄️❄️ = coldest

The temperature inside the refrigerator compartment is adjusted depending on the position of the thermostat knob.

For environment average temperatures ( $25 \pm 10^\circ \text{C}$ ), in order to get the right balance between performance and power consumption, we recommend using the thermostat positions

included in the range ❄️🌿 (ECO)

You turn off the product by setting it on the OFF position.

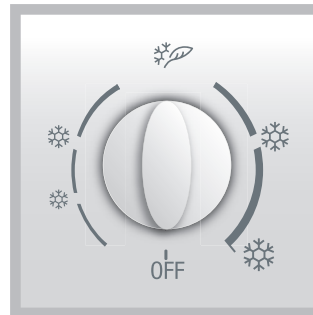

### AIR\*

Please activate the AIR feature by pressing the suitable button in order to improve the device operation with a room temperature higher than  $24^\circ \text{C}$ , if on the upper shelves there are water drops or high moisture conditions. Do not block the air inlet with foods.

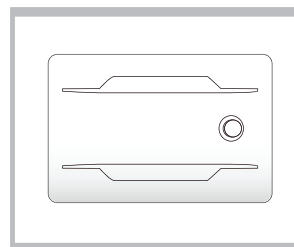

### Using the refrigerator to its full potential

- Place only cold or lukewarm foods in the compartment, never hot foods (See MULTI USE DRAWER where present)
- Remember that cooked foods do not last longer than raw foods.
- Do not store liquids in open containers: they will increase the

\* Varies by number and/or position, available only on certain models.

level of humidity in the refrigerator and cause condensation to form.

**SHELVES:**

They are removable and adjustable in height and depth thanks to the special guides, allowing easy storage of large containers and food. Height can be adjusted without complete removal of the shelf. (see the picture)

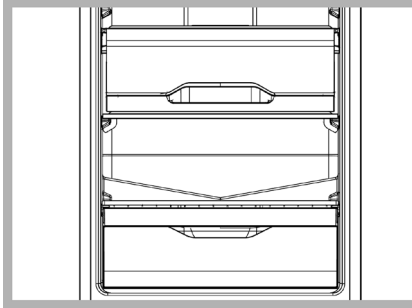
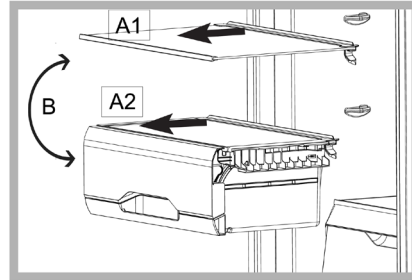
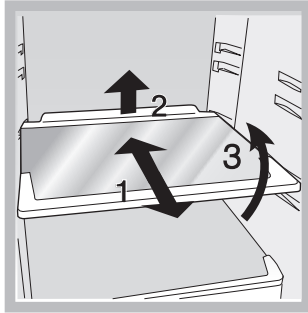

**TEMPERATURE Indicator light\***: to identify the coldest area in the refrigerator.

1. Check that OK appears clearly on the indicator light (see diagram).



2. If the word "OK" does not appear it means that the temperature is too high: set the FRIDGE TEMPERATURE on a colder value, and then wait 10 hours until the temperature becomes stable.
3. Check the indicator light again: if necessary, readjust it following the initial process. If large quantities of food have been added or if the refrigerator door has been opened frequently, it is normal for the indicator not to show OK. Wait at least 10 hours before you set the FRIDGE temperature on a colder value.

**MULTI USE DRAWER\* container**

This is the new box which offers maximum flexibility in order to stock your food in an excellent way.

If you put in the low section of your fridge compartment, on the crisper box, it becomes CHILLER, and it guarantees a temperature very close to 0°C, which is ideal to:

- store meat, fish and delicate food;
- rapid cooling of hot foods;
- low temperature defrosting (it inhibits the proliferation of microorganisms).

You can get the 0°C temperature, in standard conditions, when the fridge compartment temperature is at about 4°C.

By decreasing the fridge temperature you decrease the CHILLER compartment temperature too.

If you put it in the "upper" part of the fridge compartment (A1), it will be suitable to store fruit and vegetables, thus giving you the possibility to have a second crisper box.

\* Varies by number and/or position, available only on certain models.

**Using the freezer to its full potential**

- Do not re-freeze food that is defrosting or that has already been defrosted. These foods must be cooked and eaten (within 24 hours).
  - Fresh food for freezing should not be placed in contact with the one already frozen; it should be placed in the lower FREEZER and STORAGE compartment that provides the best freezing rate.
  - To freeze fresh food in the best and safest way possible, activate the SUPER FREEZE function 24 hours before placing the food in the freezer. After placing the food inside, activate the SUPER FREEZE function again; it will be deactivated automatically after 24 hours;
  - Do not place glass bottles which contain liquids, and which are corked or hermetically sealed in the freezer because they could break.
  - The maximum quantity of food that may be frozen daily is indicated on the plate containing the technical properties located on the bottom left side of the refrigerator compartment (for example: 2Kg/24h ).
- ! To avoid blocking the air circulation inside the freezer compartment, it is advisable not to obstruct the ventilation holes with food or containers.
- ! Do not open the door during freezing.
- ! If there is a power cut or malfunction, do not open the freezer door. This will help maintain the temperature inside the freezer, ensuring that foods are conserved for at least 12-18 hours.
- ! To get more space inside your freezer, you can take out any drawers (and flaps, if appropriate), from their slots, by putting your food directly on the provided shelves.

**Maintenance and care**

**Switching the appliance off**

During cleaning and maintenance it is necessary to disconnect the appliance from the electricity supply.

It is not sufficient to set the temperature adjustment knobs on ● (appliance off) to eliminate all electrical contact.

**Cleaning the appliance**

- The external and internal parts, as well as the rubber seals may be cleaned using a sponge that has been soaked in lukewarm water and bicarbonate of soda or neutral soap. Do not use solvents, abrasive products, bleach or ammonia.

- The removable accessories may be soaked in warm water and soap or dishwashing liquid. Rinse and dry them carefully.
- The back of the appliance may collect dust which can be removed by delicately using the hose of a vacuum cleaner set on medium power. The appliance must be switched off and the plug must be pulled out before cleaning the appliance.

### Avoiding mould and unpleasant odours

- The appliance is manufactured with hygienic materials which are odour free. In order to maintain an odour free refrigerator and to prevent the formation of stains, food must always be covered or sealed properly.
- If you want to switch the appliance off for an extended period of time, clean the inside and leave the doors open.

### Replace LED \* light

The LED lighting, thanks to the powerful diffused light, allows a clear view of each food. If you need to replace the LED light, contact the Technical Service.

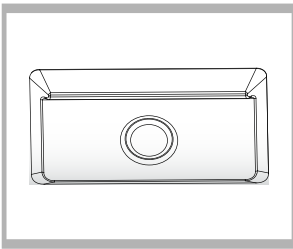

### Replacing the light bulb \*

To replace the light bulb in the refrigerator compartment, pull out the plug from the electrical socket. Follow the instructions below. Access the light bulb by removing the cover as indicated in the diagram. Replace it with a similar light bulb within the power range indicated on the cover.

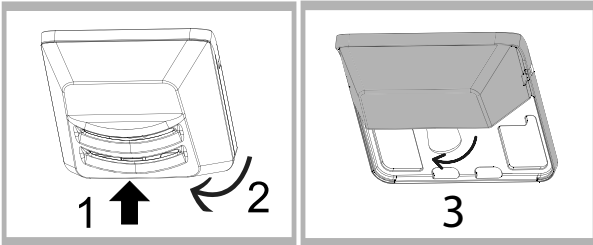

## Precautions and tips

! The appliance was designed and manufactured in compliance with international safety standards. The following warnings are provided for safety reasons and must be read carefully.

This appliance complies with the following Community Directives:  
 - 73/23/EEC of 19/02/73 (Low Voltage) and subsequent amendments;  
 - 89/336/EEC of 03.05.89 (Electromagnetic Compatibility) and subsequent amendments;  
 - 2002/96/CE.



### General safety

- The appliance was designed for domestic use inside the home and is not intended for commercial or industrial use.
- The appliance must be used to store and freeze food products by adults only and according to the instructions in this manual.
- The appliance must not be installed outdoors, even in covered areas. It is extremely dangerous to leave the appliance exposed to rain and storms.

- Do not touch the appliance with bare feet or with wet or moist hands and feet.
- Do not touch the internal cooling elements: this could cause skin abrasions or frost/freezer burns.
- When unplugging the appliance always pull the plug from the mains socket, do not pull on the cable.
- Before cleaning and maintenance, always switch off the appliance and disconnect it from the electrical supply. -It is not enough to turn off the device (with the ● button) to eliminate all electric contacts.
- In the case of a malfunction, under no circumstances should you attempt to repair the appliance yourself. Repairs carried out by inexperienced persons may cause injury or further malfunctioning of the appliance.
- Do not use any sharp or pointed utensils or electrical equipment - other than the type recommended by the manufacturer - inside the frozen food storage compartments.
- Do not put ice cubes taken directly from the freezer into your mouth.
- This appliance is not intended for use by persons (including children) with reduced physical, sensory or lack of experience and knowledge unless they have been given Supervision or instruction concerning use of the appliance by a person responsible for their safety. Children should be Supervised to ensure that they do not play with the appliance.
- Keep packaging material out of the reach of children! It can become a choking or suffocation hazard.

### Disposal

- Observe local environmental standards when disposing packaging material for recycling purposes.
- The European Directive 2012/19/EU on Waste Electrical and Electronic Equipment (WEEE), requires that old household electrical appliances must not be disposed of in the normal unsorted municipal waste stream. Old appliances must be collected separately in order to optimise the recovery and recycling of the materials they contain and reduce the impact on human health and the environment. The crossed out "wheeled bin" symbol on the product reminds you of your obligation, that when you dispose of the appliance it must be separately collected. Consumers should contact their local authority or retailer for information concerning the correct disposal of their old appliance.

### Respecting and conserving the environment

- Install the appliance in a fresh and well-ventilated room. Ensure that it is protected from direct sunlight and do not place it near heat sources.
- Try to avoid keeping the door open for long periods or opening the door too frequently in order to conserve energy.
- Do not fill the appliance with too much food: cold air must circulate freely for food to be preserved properly. If circulation is impeded, the compressor will work continuously.
- Do not place hot food directly into the refrigerator. The internal temperature will increase and force the compressor to work harder and will consume more energy.
- Defrost the appliance if ice forms (see Maintenance). A thick layer of ice makes cold transference to food products more difficult and results in increased energy consumption.

\* Varies by number and/or position, available only on certain models.

# Troubleshooting

If the appliance does not work, before calling for Assistance (see Assistance), check for a solution from the following list.

## **The internal light does not illuminate.**

- The plug has not been inserted into the electrical socket, or not far enough to make contact, or there is no power in the house.
- The TEMPERATURE ADJUSTMENT knob is not in the correct position.

## **The motor does not start.**

- The appliance comes with a motor protection control (see Start-up and use).

## **The refrigerator and the freezer do not cool well.**

- The doors do not close properly or the seals are damaged.
- The doors are opened too frequently.
- The refrigerator or the freezer have been over-filled.

## **The food inside the refrigerator is beginning to freeze.**

- The TEMPERATURE ADJUSTMENT knob is not in the correct position.

## **The motor runs continuously.**

- The door is not closed properly or is continuously opened.
- The outside ambient temperature is very high.

## **The appliance makes a lot of noise.**

- The appliance has not been installed on a level surface (see Installation).
- The appliance has been installed between cabinets that vibrate and make noise.
- The internal refrigerant makes a slight noise even when the compressor is off. This is not a defect, it is normal.

## **Some of the external parts of the refrigerator become hot.**

- These raised temperatures are necessary in order to avoid the formation of condensation on certain parts of the product.

