



Russell Hobbs



instructions

£10,000 prize draw
EXTRA year guarantee
FREE rewards gallery
www.productregister.co.uk/rhobbs
Register online now!
See back for details

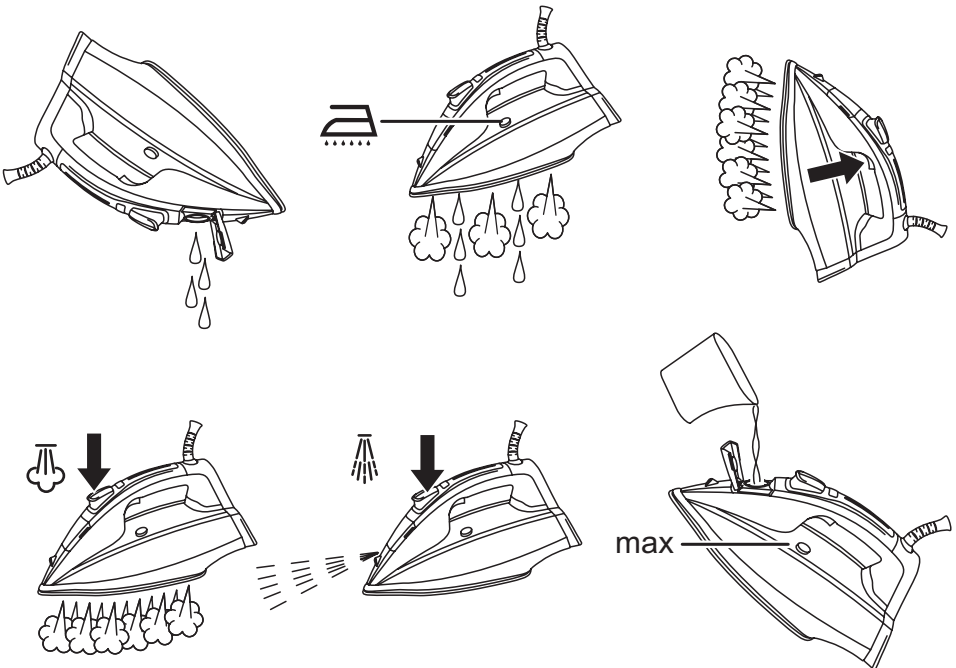
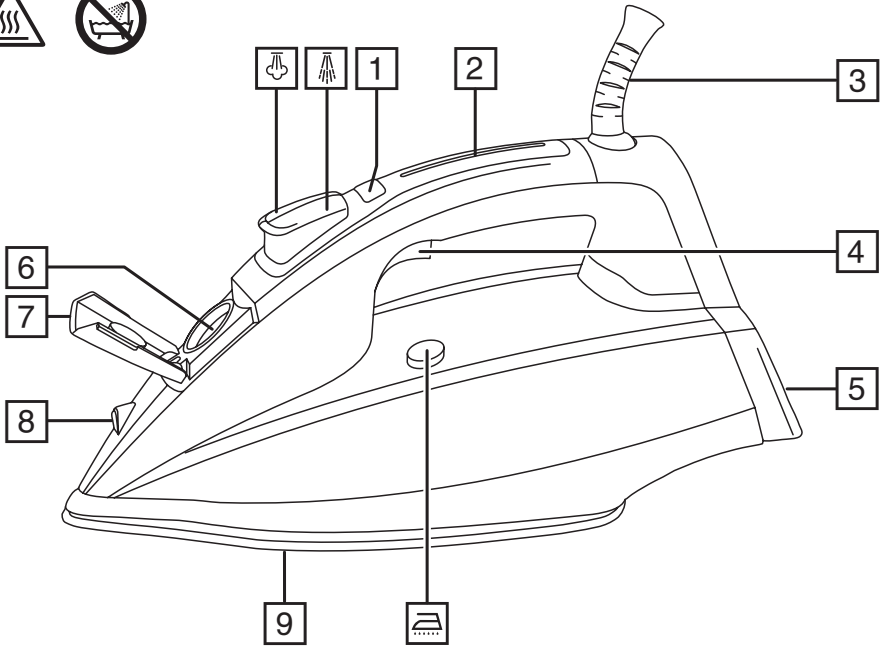

Read the instructions, keep them safe, pass them on if you pass the iron on.

IMPORTANT SAFEGUARDS

Follow basic safety precautions, including:

This appliance can be used by children aged from 8 years and above and persons with reduced physical, sensory or mental capabilities or lack of experience and knowledge if they have been supervised/instructed and understand the hazards involved. Children shall not play with the appliance. Cleaning and user maintenance shall not be done by children unless they are older than 8 and supervised. Use and store the appliance out of reach of children under 8 years.

Use the iron, or set it on its heel, on a stable, level, heat-resistant surface, preferably an ironing board.

Don't leave the iron unattended while plugged in, or while it's standing on the ironing board.

Unplug the iron before filling, before cleaning, and after use.

Don't operate the appliance if it's dropped or damaged, or if it malfunctions or leaks.

If the cable is damaged, return the iron, to avoid hazard.



 The surfaces of the appliance will get hot during use.

- Don't put the appliance in liquid, don't use it in a bathroom, near water, or outdoors.
- Don't iron clothing while it's being worn – you'll injure the wearer.
- Don't use the appliance for any purpose other than those described in these instructions.
- Don't scratch the soleplate – avoid buttons, zips, etc.
- The appliance has a protective thermal fuse, which will blow if it overheats. If this happens, the appliance will stop working, and must be returned for repair.

HOUSEHOLD USE ONLY

- | | |
|-----------------------|-----------------|
| 1. Temperature button | 6. Water inlet |
| 2. Temperature light | 7. Cover |
| 3. Swivel cord | 8. Spray nozzle |
| 4. Steam trigger | 9. Soleplate |
| 5. Heel | |

BEFORE USING FOR THE FIRST TIME







- Remove labels, stickers and packaging from the iron and soleplate.
- Don't worry if the iron smokes a bit at first, it'll stop as the element cures.
- Iron an old piece of cotton fabric, to clean the soleplate.
- Press the  and  buttons 3 or 4 times, to check them.

AUTO SHUT-OFF





- If the iron is motionless, it will switch off after about 30 seconds with the soleplate down, or about 8 minutes if it's upright.
- The temperature light will flash yellow, and keep flashing till you move the iron.

- To switch on again, lift it up, tilt it forward, then sit it upright to return to operating temperature.
- The temperature light will flash the colour appropriate to the current setting till it reaches operating temperature

PREPARATION

1. Check for textile care symbols (   .
2. Iron fabrics needing low temperatures  first, then those that need medium temperatures , and finish with those needing high temperatures .

TEMPERATURE SETTING GUIDE

Label marking	Dot setting
 cool – nylon, acrylics, polyester	•
 warm – wool, polyester mixtures	••
 hot – cotton, linen	•••
Max – denim	Max
 do not iron	-

If the instructions on the fabric label differ from this guide, follow the instructions on the label.

FILLING

You may use the iron with tap-water, but if you live in a hard water area, you should use distilled water (not chemically descaled or softened water).

If you buy distilled water, check that it's marketed as suitable for use in irons.

1. Unplug the iron.
2. Open the water inlet cover.
3. Hold the iron with the soleplate down.
4. Pour slowly, to let the air in the reservoir escape, otherwise you'll cause an air lock and the water will overflow.
5. Don't fill past **max**, or water will escape in use.
6. Wipe up any spillage.

SWITCH ON

1. Sit the iron on its heel.
2. Put the plug into the power socket (switch the socket on, if it's switchable). The iron will beep and the light in the handle will come on yellow, to show it's in standby mode.
3. Press and release the temperature button to select the temperature you want.
4. The colour of the temperature light depends on the setting. The colours are:

Temperature light colour	Dot setting
Yellow	On - standby mode
Blue	•
Purple	••
Green	•••
Red	Max

5. The temperature light will flash while the iron is heating up, then come on continuously when the set temperature is reached.

REDUCING TEMPERATURE

This takes a bit longer, as the iron has to lose the heat it has built up, so be patient. It's best to organise your ironing so that you don't need to reduce the temperature.

STEAM IRONING

1. When steam ironing, you must set the temperature to ●●● (green) or max (red).
2. If you don't, you'll get water on your clothes, not steam.
3. Wait till the temperature light stops flashing, then start ironing.
4. Pull and hold the steam trigger whenever you want steam. Release it to stop.

SPRAY

Water spotting affects some fabrics. Test this out on a hidden part of the fabric. This works with dry or steam ironing, as long as there's water in the reservoir.

1. Check that there's water in the reservoir.
2. Lift the iron off the fabric.
3. Aim the spray nozzle at the fabric.
4. Press the  button – you may have to press it 2 or 3 times to pump water through the system.

SHOT OF STEAM

This works with dry or steam ironing, as long as there's water in the reservoir, and the temperature is set to ●●● (green) or max (red).

1. Check that there's water in the reservoir.
2. Check that the temperature is set to ●●● (green) or max (red).
3. Lift the iron off the fabric.
4. Press the  button.
5. Leave 4 seconds between shots, to let the temperature build up.

DRY IRONING

If you're going to be dry ironing for 20 minutes or more, empty the reservoir first, to avoid spontaneous bursts of steam.

1. Select the required temperature.
2. Wait till the temperature light stops flashing, then start ironing.
3. Don't press the steam trigger when dry ironing.

VERTICAL STEAMING

Remove wrinkles from hanging clothes, hanging curtains, and furnishing fabrics.

- Check that there's adequate ventilation behind the fabric, otherwise moisture may build up, causing mildew.
 - Check that there's nothing behind the fabric that may be damaged by the steam.
 - Check that pockets, turn-ups, and cuffs are empty.
 - Check that there's water in the reservoir.
1. Set the temperature control to max (red).
 2. Wait till the light stops flashing.
 3. Hold the iron close to (but not touching) the fabric.
 4. Pull and hold the steam trigger whenever you want steam. Release it to stop.



AFTER USE

1. Unplug the iron.
2. Open the water inlet cover.
3. Turn the iron upside down over a sink, and drain the reservoir.
4. Close the water inlet cover, and wipe off any moisture.
5. Sit the iron on its heel till it's cold.
6. Wipe outer surfaces with a damp cloth.
7. Remove spots from the soleplate with a little vinegar.
8. Store the iron on its heel, to avoid corrosion.

SELF CLEAN

To reduce scale build-up, use the self clean function at least monthly in normal water areas, more often in hard water areas.

You'll need a basin or a large bowl to catch the water coming out of the soleplate.

1. Fill the reservoir to the max mark.
2. Sit the iron on its heel.
3. Put the plug into the power socket.
4. Set the temperature to max (red), and wait till the temperature light stops flashing.
5. Now hold the iron over the basin or bowl, with the soleplate down.
6. Press the  button and hold it down.
7. Gently move the iron to and fro, over the basin or bowl.
8. Water and steam will wash scale and dust through the soleplate.
9. When the reservoir is empty, release the  button.
10. Unplug the iron, and sit it on its heel to cool.

ANTI-SCALE

The anti-scale agent incorporated in the iron helps prevent the build-up of scale. Don't use a descaling solution, or you'll destroy the anti-scale agent.



ENVIRONMENTAL PROTECTION

To avoid environmental and health problems due to hazardous substances in electrical and electronic goods, appliances marked with this symbol mustn't be disposed of with unsorted municipal waste, but recovered, reused, or recycled.

SERVICE

If you ring Customer Service, please have the **Model No.** to hand, as we won't be able to help you without it. It's on the rating plate (usually underneath the product).

The product isn't user-serviceable. If it's not working, read the instructions, check the plug fuse and main fuse/circuit breaker. If it's still not working, consult your retailer.

If that doesn't solve the problem – ring Customer Service – they may be able to offer technical advice.

If they advise you to return the product to us, pack it carefully, include a note with your name, address, day phone number, and what's wrong. If under guarantee, say where and when purchased, and include proof of purchase (till receipt). Send it to:

Customer Service

Spectrum Brands (UK) Ltd

Fir Street, Failsworth, Manchester M35 0HS

email: support@russellhobbs.com

telephone: 0845 658 9700 (local rate number)

GUARANTEE

Defects affecting product functionality appearing within two years of first retail purchase will be corrected by replacement or repair provided the product is used and maintained in accordance with the instructions. Your statutory rights are not affected. Documentation, packaging, and product specifications may change without notice.



ONLINE

www.russellhobbs.co.uk for more products



REGISTER ONLINE FOR –



£10,000 prize draw,

EXTRA year guarantee,

FREE rewards gallery

Visit www.productregister.co.uk/rhobbs

You must register within 28 days of purchase.