

Jasmine Duo Love Seat

Assembly Instructions - Please keep for future reference

790/8507

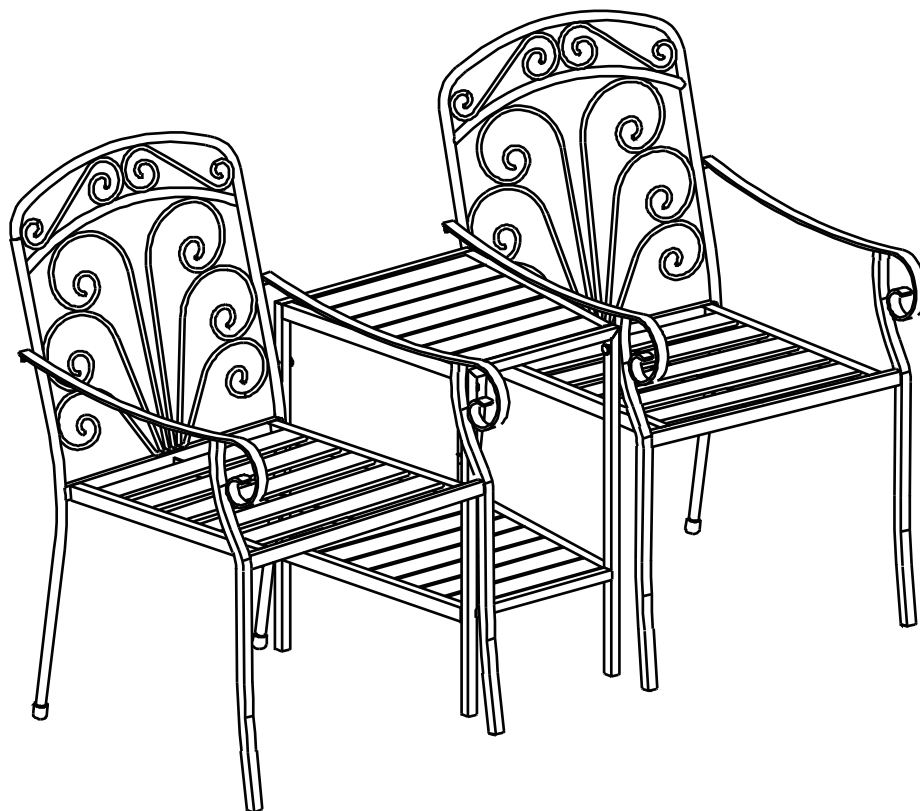

Dimensions

Depth-63cm
Width-138cm
Height-95cm

Important – Please read these instructions fully before starting assembly

If you need help or have damaged or missing parts, call the Customer Helpline: 03456 400800
For further assistance please visit <http://www.argos-support.co.uk/>



Safety and Care Advice

Important – Please read these instructions fully before starting assembly

- Check you have all the components and tools listed on page 2.
- Remove all fittings from the plastic bags and separate them into their groups.
- Keep children and animals away from the work area, small parts could choke if swallowed.
- Make sure you have enough space to layout the parts before starting.

- Do not stand or put weight on the product during assembly, this could cause damage.
- Assemble the item as close to its final position (in the same room) as possible.
- Assemble on a soft level surface to avoid damaging the table or your floor.
- Parts of the assembly will be easier with 2 people.



power drill is set on a low torque setting.

- To reduce the likelihood of damaging your product please ensure that your

Care and maintenance

- This product has been designed for careful domestic outdoor use.
- Make sure each screw matches the corresponding figure to ensure correct assembly.

- From time to time check that there are no loose screws on this chair.
- Only clean using a damp cloth and mild detergent, do not use bleach or abrasive cleaners.

- Do not fully tighten all screws until assembly is complete.
- This product should not be discarded with household waste. Take to your local authority waste disposal centre.

Components - Parts

Please check you have all the parts listed below



1 Right chair x1

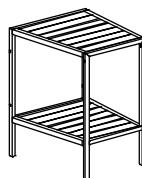

2 Side table x1







3 Left chair x1

Components - Fittings

Please check you have all the fittings listed below

Note: The quantities below are the correct amount to complete the assembly.

<p>A </p> <p>M6*35mm x 6</p>	<p>B </p> <p>Metal washer x 6</p>	<p>C </p> <p>Plastic cap x 6</p>
<p>D </p> <p>Allen key x1</p>		

Ruler - Use this ruler to help correctly identify the screws

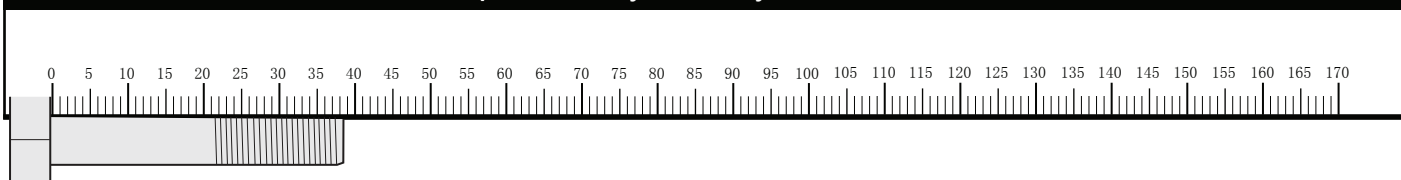

Assembly Instructions

Step 1

Assembly frame

Assembly should be carried out by two people.

Use allen key **D**, screws **A**, metal washer **B**, caps **C** to fix right chair **1** to side table **2**.



Important:
Do not fully tighten all screws until assembly is complete.

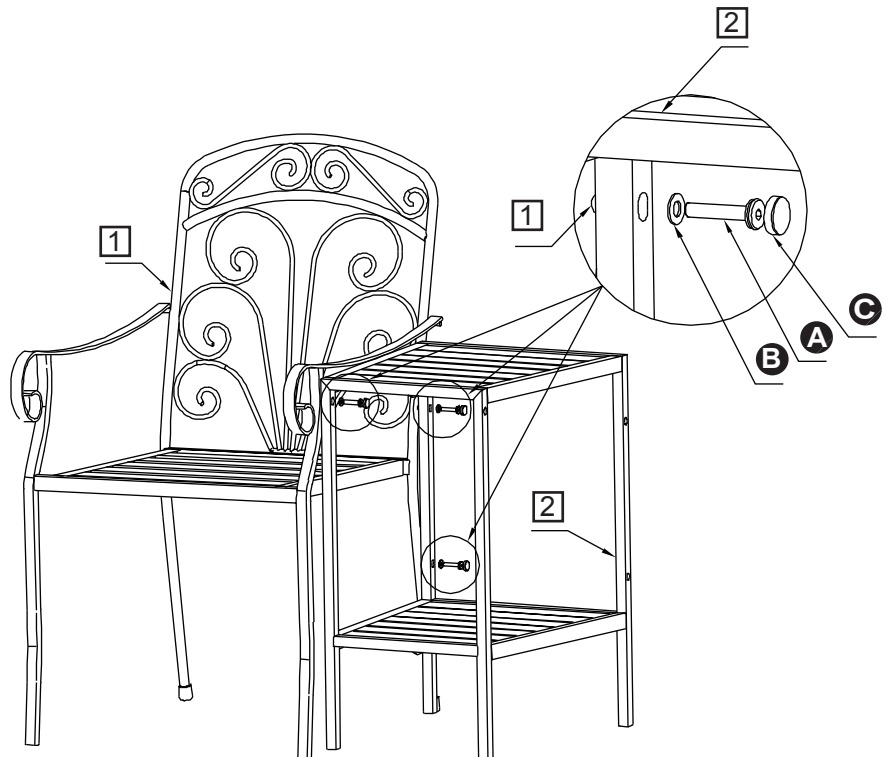

Step 2

Repeat step 1

Use allen key **D**, screws **A**, metal washer **B**, caps **C** to fix left chair **3** to side table **2**.

Tighten all the screws

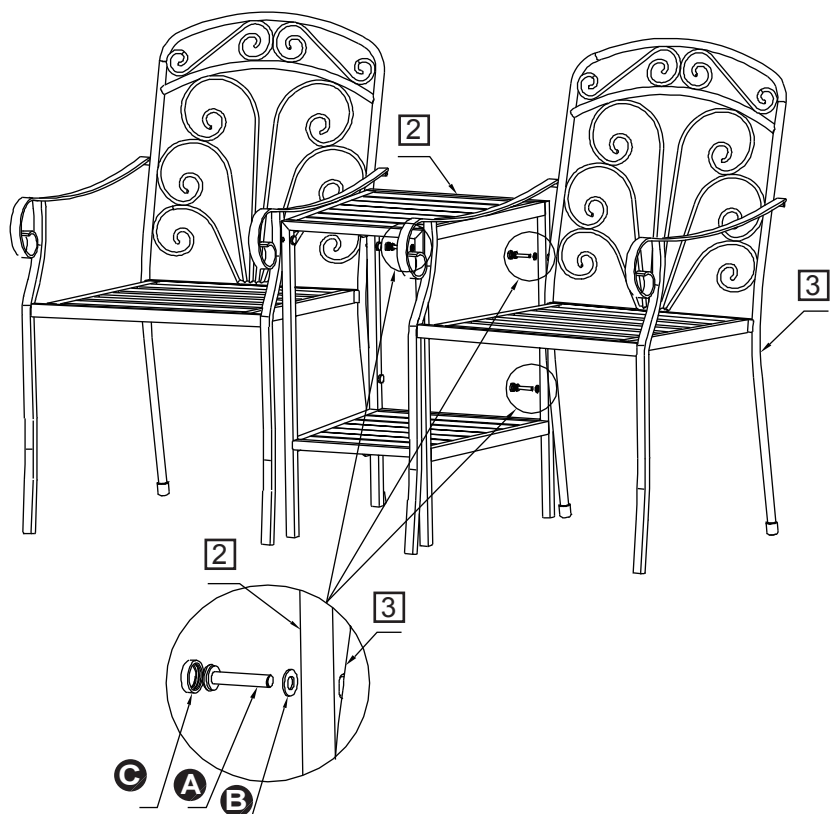

Assembly Instructions

Step 3

Assembly is complete.

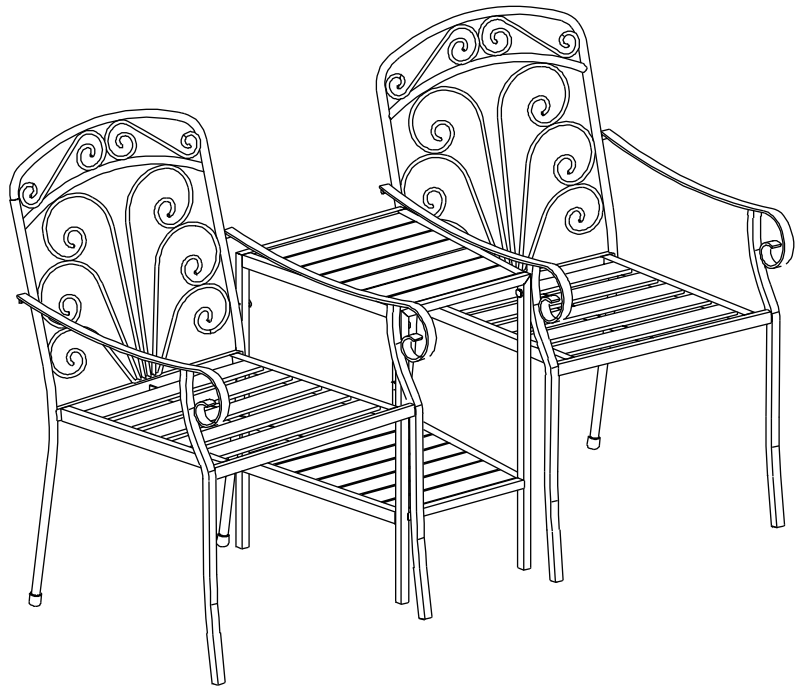

If you need help or have damaged or missing parts, call the **Customer Helpline: 03456 400800**
For further assistance please visit <http://www.argos-support.co.uk/>
Argos Limited
489-499 Avebury Boulevard Saxon Gate West Central Milton Keynes Bucks, MK9 2NW