

PedalPals

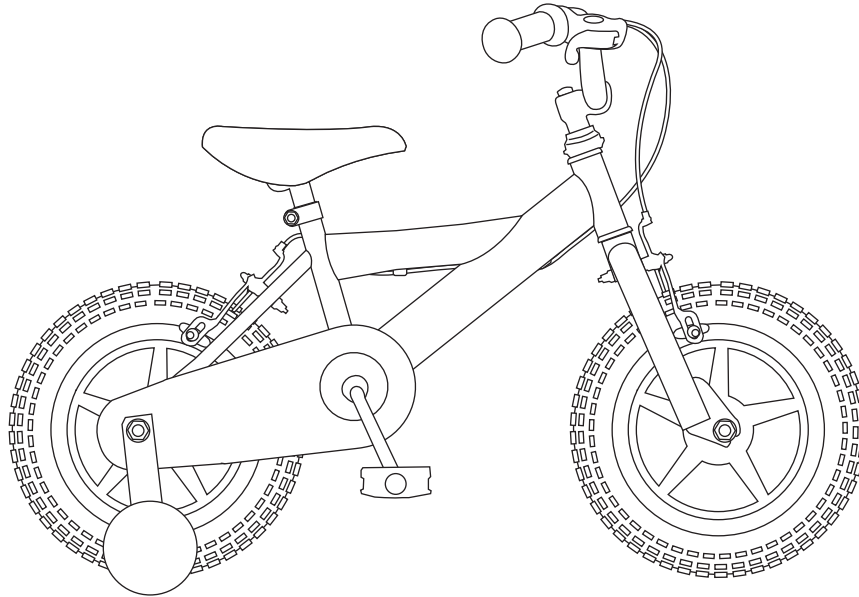

QUICK ASSEMBLY GUIDE

CONTENTS

WARNINGS.....	<i>page 2</i>	FITTING THE STABILISERS.....	<i>page 9</i>
BOX CONTENTS.....	<i>page 3</i>	FITTING THE PEDALS.....	<i>page 10</i>
FITTING THE HANDLEBAR.....	<i>page 4</i>	FITTING THE REFLECTORS.....	<i>page 11</i>
FITTING THE SADDLE	<i>page 5</i>	FINAL CHECKS.....	<i>page 12</i>
FITTING THE FRONT WHEEL.....	<i>page 6</i>		

WARNINGS

- Always check that brakes work before each use - failure to set brakes correctly may result in serious injury or even death.
- Ensure all nuts / bolts / screws are securely tightened and checked before use. Recommended torques (tightness levels) are available in the owners manual.
- Check bike regularly for signs of damage. Do not use again until repaired.
- Keep your bike in good condition by cleaning off dirt, keeping it well maintained and storing in a dry place.
- Always wear a helmet that meets the latest safety standards and make sure you follow the manufacturers instructions.



**IF YOU NEED ASSISTANCE WITH ASSEMBLY PLEASE CALL
OUR CUSTOMER HELPLINE ON 0161 813 1745**

BOX CONTENTS

Please check contents of box carefully. If there are any parts missing please contact 03300 904 404 in the first instance where they will be able to assist you with replacements.

Below is a list of parts you should have.

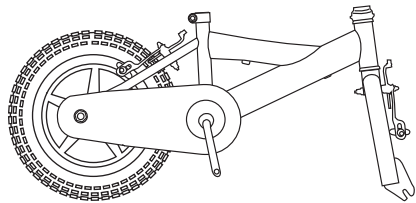

Frame Assembly

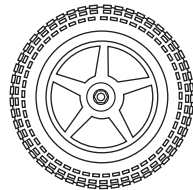

Front Wheel



Instruction Manual



Rear Reflector (Red)



Front Reflector (White)

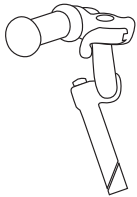

Bar Assembly

(attached to frame assembly via brake cable)

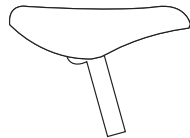

Saddle Assembly

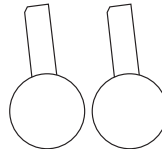

Stabilisers x 2



Pedals x 2

(make sure you have an 'L' and an 'R' as shown)



Spanner



Allen Key

IF YOU ARE EXPERIENCING ANY PROBLEMS PLEASE CALL 0161 813 1745 BEFORE RETURNING BIKE TO STORE

1.- FITTING THE HANDLEBAR

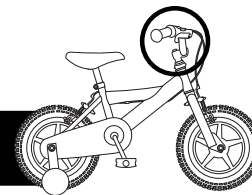

TOOLS NEEDED



SPANNER

- A** Insert the handlebar into the frame. If necessary loosen the stem bolt at the top of the handlebars and stem to allow the wedge nut to move freely. Make sure the minimum insertion mark is not visible once this is fitted. **The handlebar must be inserted beyond this point.**

- B** The handlebar must be straight. Align this with the fork by looking downwards at it. **The brakes must be facing the front of the bike.** Use the spanner to tighten the bolt on top of the handlebar stem. Do not fully tighten until the end as you may need to adjust the height.

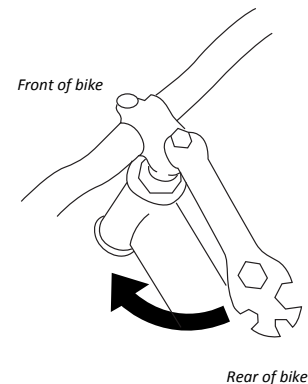
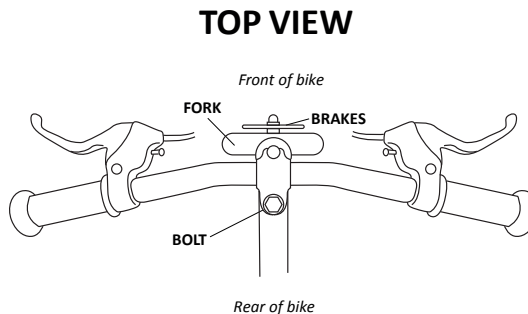
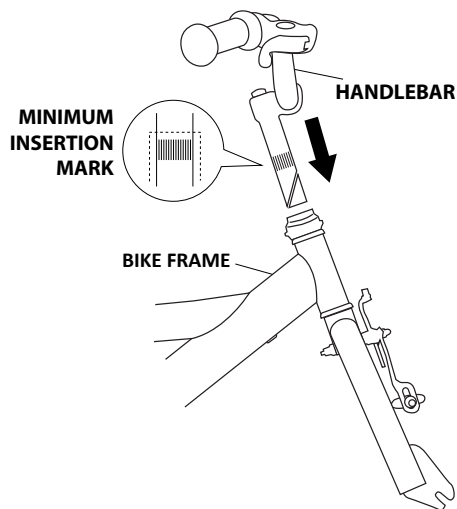

IF YOU ARE EXPERIENCING ANY PROBLEMS PLEASE CALL 0161 813 1745 BEFORE RETURNING BIKE TO STORE

2.- FITTING THE SADDLE

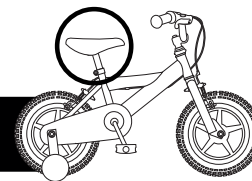

TOOLS NEEDED



SPANNER

- A** Insert saddle into frame. Make sure the minimum insertion mark is not visible once this is fitted. **The saddle must be inserted beyond this point**

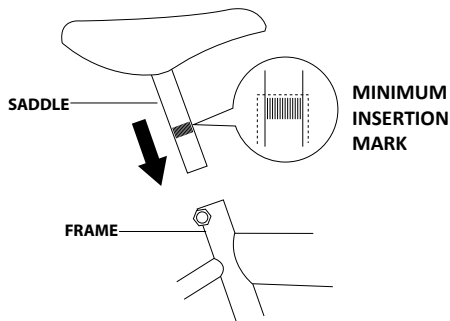

- B** Using the spanner provided, lock the seat in position by turning bolt in a clockwise direction. Do not fully tighten until the end as you may need to adjust the height.

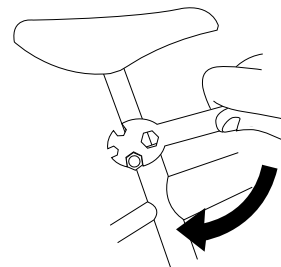

IF YOU ARE EXPERIENCING ANY PROBLEMS PLEASE CALL 0161 813 1745 BEFORE RETURNING BIKE TO STORE

3.- FITTING THE FRONT WHEEL

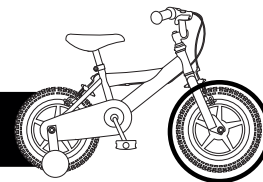

TOOLS NEEDED



SPANNER

- A** You will need to release your caliper brakes to install or replace a wheel, slightly loosen the cable pinch bolt. Turn it anti-clockwise with the spanner provided as shown. This will open up the brake pads so the wheel fits through.

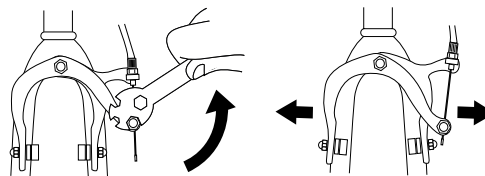

- B** Turn the bike upside down. Loosen the nuts on the front wheel axle by turning anti-clockwise - you need enough thread showing on the axle so the wheel slots easily onto the fork. Make sure the locking washers are on the outside of the fork as shown.

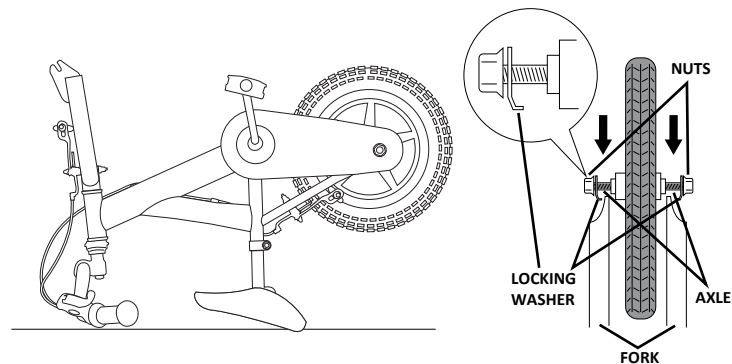

IF YOU ARE EXPERIENCING ANY PROBLEMS PLEASE CALL 0161 813 1745 BEFORE RETURNING BIKE TO STORE

C Locking washers must be positioned correctly in this step:

- i* Place the pointed side of the locking washer into the hole on the fork. **Make sure the gap between the wheel and the fork is equal on both sides.**
- ii* Tighten the nut with the spanner provided.

THE PIN ON THE LOCKING WASHER MUST BE PLACED IN THE HOLE.

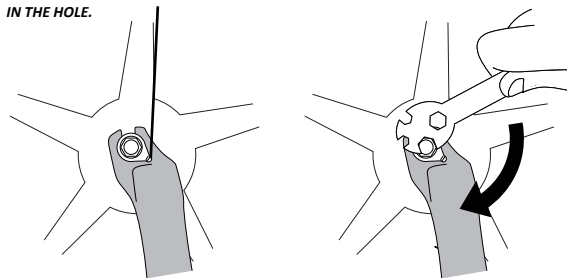

D Once the wheel is in place and tight, turn the bike the right way up and squeeze the brake arms together until there is a 1 - 1.5 mm gap between the brake pads and the rim. Both sides should be equal. Whilst holding in place you then need to pull the brake cable tight, and tighten the cable pinch bolt by turning clockwise using the spanner provided as shown.

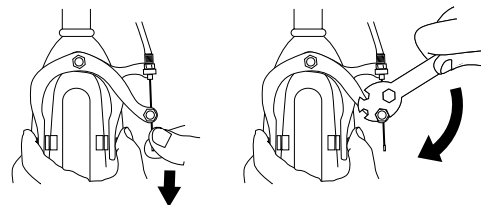

**CORRECT BRAKE & WHEEL FITTING IS VERY IMPORTANT FOR YOUR SAFETY
IF YOU HAVE ANY PROBLEMS THERE IS MORE INFORMATION IN THE USER MANUAL
FAILURE TO CORRECTLY SET THE BRAKES MAY RESULT IN SERIOUS INJURY**

IF YOU ARE EXPERIENCING ANY PROBLEMS PLEASE CALL 0161 813 1745 BEFORE RETURNING BIKE TO STORE

 **WARNING** 

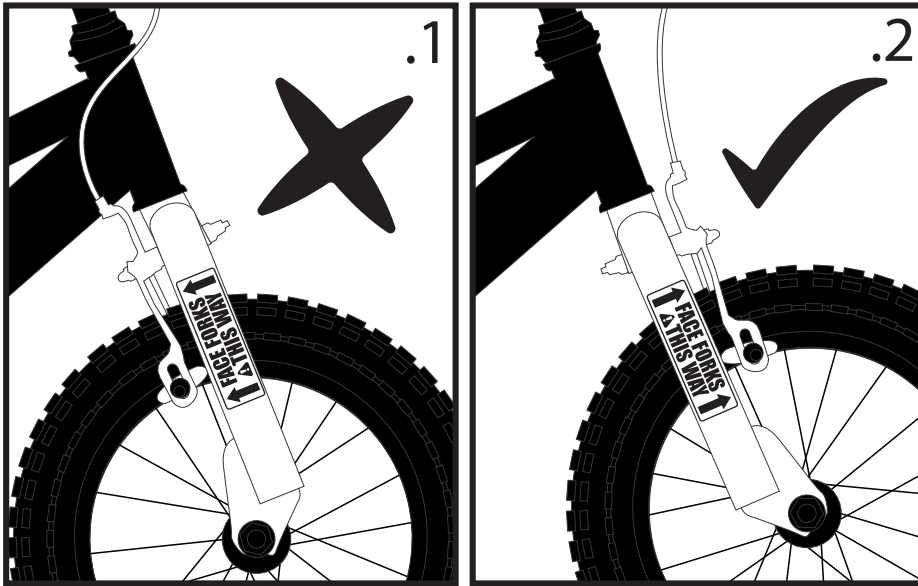

When assembling the bike make sure the forks are repositioned the correct way. The front brake needs to be facing forward away from the bike (see picture .2 above). Finally make sure the brake cable is not twisted or tangled as this will affect the braking performance.

4.- FITTING THE STABILISERS

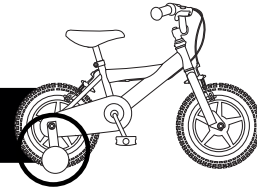

TOOLS NEEDED



SPANNER

- i* Remove the outer nut and washer from each side of the back wheel by turning anti-clockwise using the spanner provided
- ii* Place the bracket over the thread ensuring the tabs lock in the dropout, followed by the stabiliser, the washer and the nut.
- iii* Tighten the nut by turning clockwise until it is finger tight. Repeat for the other side.
- iv* Once both stabilisers are finger tight, ensure they are both around 5mm from the ground with the bike vertical. This is to ensure that if the bike goes over uneven ground the rear wheel won't be lifted of the ground causing it to lose traction.
- v* Tighten both nuts by turning clockwise using the spanner provided

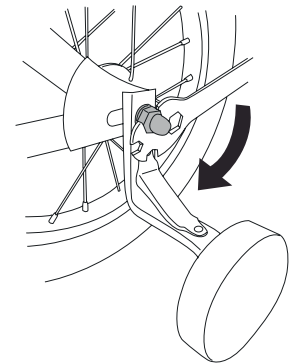
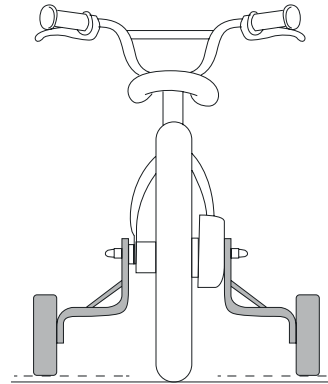
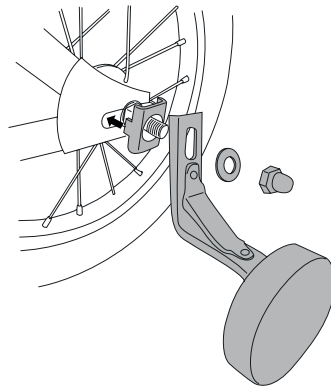
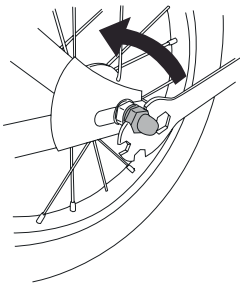

IF YOU ARE EXPERIENCING ANY PROBLEMS PLEASE CALL 0161 813 1745 BEFORE RETURNING BIKE TO STORE

5.- FITTING THE PEDALS

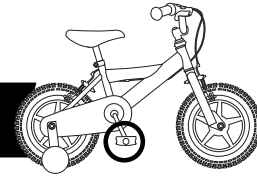

TOOLS NEEDED



SPANNER

To fit the pedals correctly, you must position them the correct way around and screw them on in the right direction:

- i* Stickers indicate the left and right pedal. If these have dropped off, look at the end of the thread where it is imprinted.
- ii* The correct pedal needs to be attached to the matching side of the bike i.e. left pedal to left side and right pedal to right side.
- iii* **IMPORTANT! Pedals need screwing in opposite directions so they don't fall off in use.**
Left pedal is screwed in anti-clockwise / Right pedal is screwed in clockwise. Tighten pedals with spanner provided.

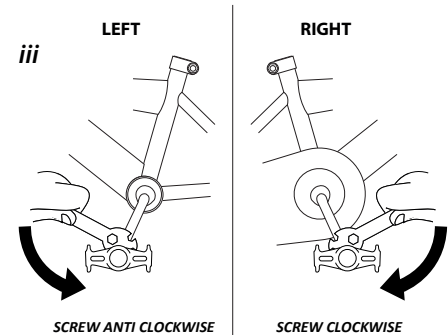
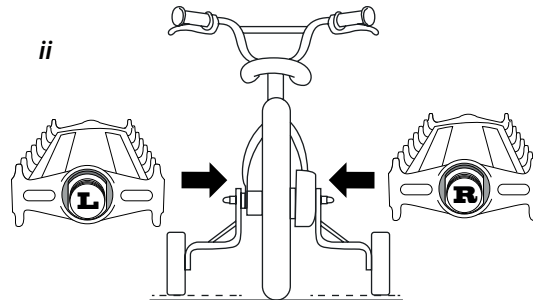
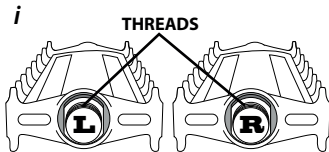

PLEASE MAKE SURE YOU FIT THE CORRECT PEDAL TO THE CORRECT SIDE. FAILURE TO DO SO MAY RESULT IN CROSS-THREADING, WHICH CAN CAUSE IRREPARABLE DAMAGE NOT COVERED BY WARRANTY

6.- FITTING THE REFLECTORS

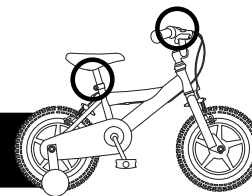

TOOLS NEEDED



ALLEN KEY

- A** First fully release the securing screws as shown (anti-clockwise)

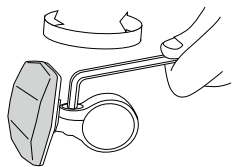

RED REFLECTOR

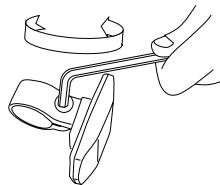

WHITE REFLECTOR

- B** Wrap the white reflector around the handlebar near the centre, and wrap the red reflector in the same way around the saddle post.

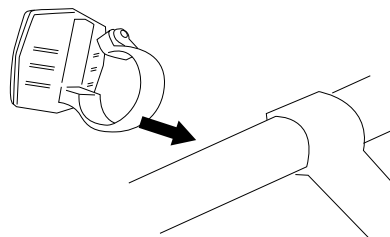

HANDLEBAR
(Bell and White Reflector)

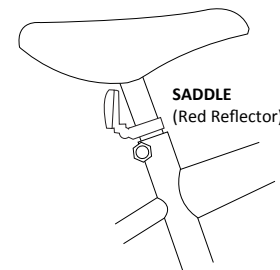

SADDLE
(Red Reflector)

- C** Once these are in place, replace the screws and tighten by turning clockwise using allen key provided

7.- FINAL CHECKS

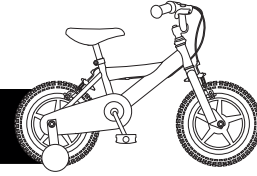

- A** You can now ensure your saddle and handlebars are at a comfortable riding position, and fully tighten. **Always be aware of the minimum insertion mark and make sure these are inserted beyond this point.**
- B** Check tyre pressures regularly. Recommended tyre pressures are clearly marked on the side of the tyre.
- C** Check that all bolts and fixings are tight and secure. You should do this before every ride.
- D** Check functionality of brakes before every ride, you will find out more about this in the user manual included.



IMPORTANT: ENSURE ALL NUTS / BOLTS / SCREWS ARE TIGHT

RECOMMENDED TORQUES IN OWNER'S MANUAL APPENDIX

PLEASE READ OWNER'S MANUAL BEFORE RIDING THIS BIKE

ALWAYS CHECK BRAKE FUNCTIONALITY BEFORE RIDING



IF YOU ARE EXPERIENCING ANY PROBLEMS PLEASE CALL 0161 813 1745 BEFORE RETURNING BIKE TO STORE