

41 cm³

Petrol Chainsaw

CS4100-3

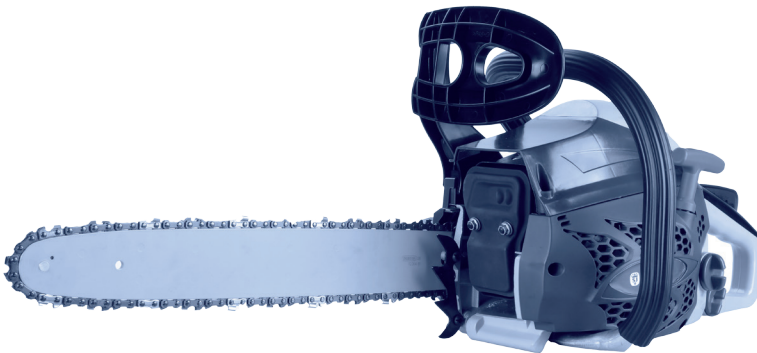

**Important - Please read these instructions
fully before starting assembly**

These instructions contain important information that will help you get the best from your chainsaw, ensuring it is assembled correctly and safely. If you need help or have damaged or missing parts, call the Customer Helpline on 0345 605 2067

**AFTER SALES SUPPORT
0345 605 2067**

SPEAR & JACKSON SINCE 1760

For more than 250 years gardeners have enjoyed high quality performance and great results using Spear & Jackson tools.

Our garden power tools combine continuous innovation and the latest in manufacturing technologies with a proud heritage.

Each product is carefully designed with performance, comfort and durability firmly in mind, which has earned Spear & Jackson an enviable reputation as a maker of tools to trust.

3 YEARS GUARANTEE

As a testament to the quality of our products, we offer a 3 year manufacturers warranty and a comprehensive after sales service.

The warranty covers manufacturing faults, however in the event that the item has been deliberately damaged, used in a commercial environment or disassembled then the warranty will be null and void.

Please retain proof of purchase.

7 DAYS A WEEK TECHNICAL SUPPORT

We want you to get the best out of your products. Our easy-to-read instruction manual guides you with best practice use and maintenance tips. Please call **0345 605 2067** for technical support, we can solve around 80% of questions directly over the phone.

We hope you enjoy your product and we look forward to any feedback, as this allows us to develop even better products for the future.

CONTENTS

Safety Information	04
Description of symbols	04
General safety	05
Preparation safety	06
Operation safety	07
Kickback safety	09
Maintenance and storage safety	10
Intended use	11
in the Box	12
Assemble	13
Prepare	14
Safety features	14
Chain brake mechanical test	15
Adjust the chain tension	16
Filling with engine fuel and lubrication oil	17
Filling the lubrication oil	18
Operate	19
Start the engine	19
Checking the oil supply	21
Check chain brake	22
Stop the engine	23
Sawing	24
Felling a tree	24
Bucking and limbing	25
Maintenance	27
Technical Data	34
Troubleshooting	36
Warranty	37

SAFETY INFORMATION

Please read these instructions fully before operating or maintaining your machine

DESCRIPTION OF SYMBOLS

The following warning symbols appear throughout this manual and indicate the appropriate safety measures you should take when operating and maintaining the electric chainsaw.



Read instruction handbook before operating this machine.



WARNING!

This is a warning symbol. This symbol is used throughout the user guide whenever there is a risk of personal injury. Ensure that these warnings are read and understood at all times..



Wear hearing protection and eye protection when using the device.



Wear protective gloves



Wear robust footwear when using the device.



Conforms to European standards.



The exhaust gas is poisonous and asphyxiating. If inhaled it may even be lethal. Do not operate the engine in closed or poorly ventilated places.



Petrol and petrol vapours are extremely flammable.



Do not touch to prevent burns.



Beware of kickback (recoil).



Guaranteed sound power level value in 114 dB



Avoid contact with the tip of the guide bar (chain return point). This will result in kickback of the chainsaw.



Do not hold the saw with one hand.



Hold the saw firmly with both hands. Place your right hand on the rear handle and your left hand on the front handle.



Do not start or use the equipment close to people (especially children) or animals. During operation, it is recommended that a minimum distance of 10 metres from other people be maintained.

SAFETY INFORMATION

Please read these instructions fully before operating or maintaining your machine



The port to refuel mixed gasoline.



The port to top up chain oil.



Setting the switch to the “O” position, the engine stops immediately.



When you start a cold engine, pull this choke out.



Shows the directions that the chain brake is released (white arrow) and activated (black arrow).



Correct direction of cutting-teeth.



Indication of chain oil adjuster screw.

GENERAL SAFETY

The chain is designed exclusively for sawing wood. You may only fell trees if you have received the appropriate training. The manufacturer cannot be held liable for damage caused by improper or incorrect usage.

Please note that our equipment has not been designed for use in commercial, trade or industrial applications. Our warranty will be voided if the machine is used in commercial, trade or industrial businesses or for the equivalent purposes.



WARNING!

- Keep this operating and maintenance manual in a safe place for reference at a later date.
- Read the instructions carefully. Be familiar with the controls and

SAFETY INFORMATION

Please read these instructions fully before operating or maintaining your machine

the proper use of the equipment.

- Never allow children or people unfamiliar with these instructions to use the chainsaw. Local regulations can restrict the age of the operator.
- Never saw while people, especially children or pets are nearby. Keep in mind that the user is responsible for accidents or hazards occurring to other people or their property.
- This appliance is not intended for use by persons (including children) with reduced physical, sensory or mental capabilities or lack of experience and knowledge, unless they have been given supervision or instruction concerning use of the appliance by a person responsible for their safety.
- Do not touch chain.

PREPARATION

WARNING!

- DO NOT operate a chainsaw with one hand! Serious injury to the operator, helpers, bystanders or any combination of these persons may result from one-handed operation. A chainsaw is intended for two-handed use only.
- Do NOT use the saw if you are tired, ill or under the influence of alcohol and/or drugs.
- Use safety footwear, snug-fitting clothing, protective gloves as well as eye, hearing and head protection devices.
- Use caution when handling fuel. Move the chainsaw at least 10 feet (3m) away from the fueling point before starting the engine.
- DO NOT allow other persons to be near when starting or cutting with the

SAFETY INFORMATION

Please read these instructions fully before operating or maintaining your machine

chainsaw. Keep bystanders and animals out of the work area.

- DO NOT start cutting until you have a clear work area, secure footing, and a planned retreat path from falling trees or branches.

OPERATION

- Keep all parts of your body away from the saw's chain when the engine is running.
 - Before you start the engine, make sure that the chain is not in contact with anything.
 - Carry the chainsaw with the engine stopped, the chain bar and saw chain facing rearwards, and with the exhaust away from your body.
 - NEVER use a chainsaw which is damaged, incorrectly set, incomplete or loosely assembled.
- Make sure that the chain rotation stops when the chain brake is applied.
 - Shut off the engine before setting the chainsaw down.
 - Use extreme caution when cutting a small size bush and saplings because slender material may catch in the saw chain and be whipped towards you or pull you off balance.
 - When cutting a limb that is under tension, be alert for spring back so that you will not be struck when the tension in the wood fibers is released.
 - Keep the handles dry, clean, and free of oil or fuel mixture.
 - Operate the chainsaw only in well-ventilated areas.
 - DO NOT operate a chainsaw from in a tree unless you have been specifically trained to do so.
 - All chainsaw servicing,

SAFETY INFORMATION

Please read these instructions fully before operating or maintaining your machine

other than the items listed in the user manual safety and maintenance instructions should be performed by competent chainsaw service personnel.

- When transporting your chainsaw, use the appropriate chain bar cover.
- DO NOT operate your chainsaw near or around flammable liquids or gases whether in or out of doors. An explosion and/or fire may result.
- Do not fill the fuel tank, oil reservoir or lubricate whilst the engine of the chainsaw is running.
- USE THE CORRECT TOOL: Cut wood ONLY. Do not use the chainsaw for purposes for which it was not intended. For example, do not use the chainsaw for cutting plastic, masonry or building materials.
- The engine will create toxic

exhaust fumes as soon as the engine is started. Never work in enclosed areas or in areas with poor ventilation.

- NOTE! The chainsaw is designed for non-commercial, occasional use for general work such as stump grubbing, cutting firewood, etc. It is not designed for lengthy use. If it is used for a lengthy period, the vibrations it causes in the hands of the user may result in circulation problems (white finger syndrome).
- The chain is designed exclusively for sawing wood. You may only fell trees if you have received the appropriate training. The manufacturer cannot be held liable for damage caused by improper or incorrect usage.
- Please note that our equipment has not been designed for use in commercial, trade or industrial applications. Our

SAFETY INFORMATION

Please read these instructions fully before operating or maintaining your machine

warranty will be voided if the machine is used in commercial, trade or industrial businesses or for the equivalent purposes.

KICKBACK

Kickback may occur when the nose or tip of the chain bar touches an object, or when the wood closes in and pinches the saw chain in the cut. If the bar tip contacts, it may cause an extremely fast reverse reaction, kicking the chain bar up and back towards the operator. Pinching the saw chain along the top of the chain bar may push the chain bar rapidly back towards the operator. Either of these reactions may cause you to lose control of the saw, which could result in serious personal injury. Do not rely exclusively upon the safety devices built into your saw. As a chainsaw user, you should take several

steps to keep your cutting jobs free from accident or injury.

- **NOTE!** With a basic understanding of kickback, you can reduce or eliminate the element of surprise. Sudden surprise contributes to accidents.
- Keep a good firm grip on the saw with both hands, the right hand on the rear handle, and the left hand on the front handle, when the engine is running. Use a firm grip with thumbs and fingers encircling the chainsaw handles. A firm grip will help you reduce kickback and maintain control of the saw. Never let go of the Chainsaw.
- Make sure that the area in which you are cutting is free from obstructions. Do not let the nose of the chain bar contact a log, branch, or any other obstruction which could be hit while you are operating the saw.

SAFETY INFORMATION

Please read these instructions fully before operating or maintaining your machine

- Cut at high engine speeds.
- Do not overreach or cut above shoulder height.
- Follow the manufacturer's sharpening and maintenance instructions for the saw chain.
- Only use replacement bars and chains specified by the manufacturer or the exact equivalent.
- PINCHING the saw chain along the **BOTTOM** of the cutting (chain) bar may **PULL** the saw forward away from the operator.
- PINCHING the saw chain along the **TOP** of the cutting (chain) bar may **PUSH** the chain bar rapidly back towards the operator.
- Any of these reactions may cause you to lose control of the saw, which could result in serious personal injury.

Beware of the following:
Rotary recoil.

When cutting from under an object using the top of the chain the object may pinch the chain and cause either a forward force on the chainsaw or a rearward force on the object.

When cutting from the top surface of an object using the bottom of the chain the object may pinch the chain and cause either a rearward force on the chainsaw or a forward force on the object.

MAINTENANCE AND STORAGE SAFETY

- Keep all nuts, bolts and screws tight to be sure the equipment is in safe working condition;
- Never store the equipment with petrol in the tank inside a building where fumes can reach an open flame or spark;
- Allow the engine to cool before storing in any

SAFETY INFORMATION

Please read these instructions fully before operating or maintaining your machine

enclosure;

- To reduce the fire hazard, keep the engine, silencer and petrol storage area free of hedge, leaves, or excessive grease;
- Replace worn or damaged parts for safety;
- If the fuel tank has to be drained, this should be done outdoors.
- NOTE! Dispose of soiled maintenance material and operating materials at the appropriate collection point. Recycle packaging material, metal and plastics.

Any use of the machine that deviates from its intended use and is not included in these instructions is considered unauthorized use and relieves the manufacturer from his or her legal liability.

INTENDED USE

This machine may only be used outdoors for cutting wood and in combination with the original cutting chains.

This machine is not designed for heavy duty or commercial use.

IN THE BOX

PARTS

- | | | | |
|----|--------------------------------|----|---------------------|
| 1 | Front handle | 12 | Start handle |
| 2 | Brake lever/hand guard | 13 | Throttle trigger |
| 3 | Saw chain | 14 | Safety trigger lock |
| 4 | Chain bar | 15 | Air filter cover |
| 5 | Chain cover | 16 | Stop switch |
| 6 | Choke control lever | 17 | Chain catcher |
| 7 | Chain tension adjustment wheel | 18 | Bar sheath |
| 8 | Chain cover tighten wheel | 19 | Chain oil 100ml |
| 9 | Primer bulb | 20 | Plug wrench |
| 10 | Fuel cap | 21 | Mixing bottle |
| 11 | Lubrication oil cap | | |

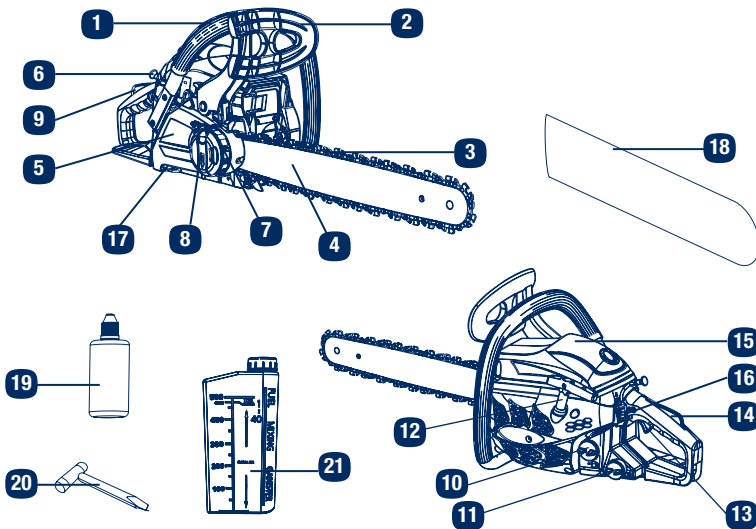

You will also need :

- 2-Stroke engine oil according JASO FC classic,
- unleaded petrol
- special chainsaw oil (100ml supplied).

Any parts missing? Call the customer helpline on 0345 605 2067, most parts can be send out on next day delivery.

1 Unpacking

- i. Unpack all parts and lay them on a flat, stable surface.
- ii. Remove all packing materials and shipping devices if applicable.
- iii. Make sure the delivery contents are complete and free of any damage. If you find that parts are missing or show damage do not use the product but contact the aftersales service within 28 days of purchase. Using an incomplete or damaged product represents a hazard to people and property.
- iv. Ensure that you have all the accessories and tools needed for assembly and operation. This also includes suitable personal protective equipment.

This product is free to assemble.

PREPARE

SAFETY FEATURES

- 3 LOW KICKBACK SAW CHAIN:** helps significantly reduce kickback, or the intensity of kickback, due to specially designed depth gauges and guard links.
- 2 CHAIN BRAKE LEVER / HAND GUARD:** protects the operator's left hand in the event it slips off the front handle while saw is running.
CHAIN BRAKE: it is a safety feature designed to reduce the possibility of injury due to kickback by stopping a moving saw chain in milliseconds. It is activated by the CHAIN BRAKE lever.
- 16 STOP SWITCH:** immediately stops the engine when tripped. Stop switch must be pushed to the "START" position to start or restart engine.
- 14 SAFETY TRIGGER LOCK:** prevents accidental acceleration of the engine. Throttle trigger cannot be squeezed unless the safety latch is depressed.
- 17 CHAIN CATCHER:** reduces the danger of injury in the event saw chain breaks or derails during operation. The chain catcher is designed to intercept a whipping chain.

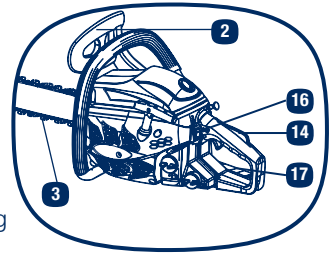

NOTE! Study your saw and be familiar with its parts.

PREPARE

CHAIN BRAKE MECHANICAL TEST



WARNING!

The purpose of the chain brake is to reduce the possibility of injury due to kickback; however, it cannot provide the intended measure of protection if the saw is operated carelessly.

Always test the chain brake before using your saw and periodically while on the job.

Your chainsaw is equipped with a chain brake that reduces possibility of injury due to kickback. The brake is activated if pressure is applied against the brake lever when, as in the event of kickback, the operator's hand strikes the lever. When the brake is actuated, chain movement stops abruptly.

To test the chain brake

- a. The Chain brake is **DISENGAGED** (chain can move) when the **BRAKE LEVER IS PULLED BACK AND LOCKED**.
- b. The chain brake is **ENGAGED** (the chain is locked) when the brake lever is pushed forward. It should not be possible to move the chain.

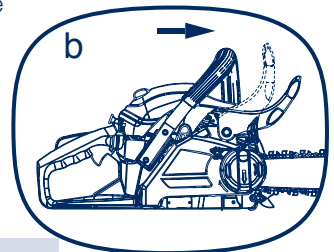
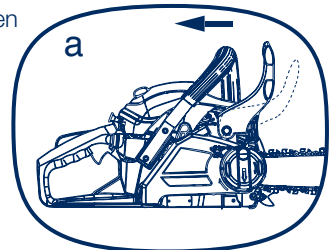

NOTE! The brake lever should snap into both positions. If this is not the case do not use your saw. Contact the helpline immediately on 0345 605 2067.

PREPARE

ADJUST THE CHAIN TENSION

1. Place the chainsaw on a flat ground. Slide the chain cover lever (A) out, and slightly loosen the chain cover (anti-clockwise rotating).

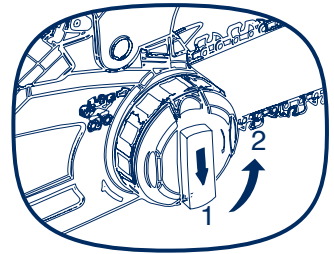

2. While holding the bar, adjust the chain tension by turning the chain tension adjust wheel (B) until the chain engages in the bar channel.

Clockwise= Tighten

Anti-clockwise= Loosen

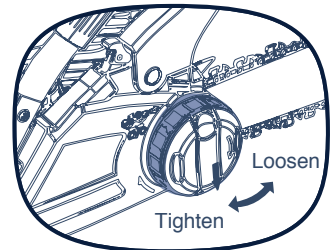

3. Tighten bar knob securely (clockwise). Hand tighten only!



NOTE! When tensioned correctly it should be possible to pull one full chain link free of the bar channel with ease.

- A new chain will expand its length during the first period of use. Check and re-adjust the tension frequently as a loose chain can easily derail or cause rapid wear of itself and the chain bar.

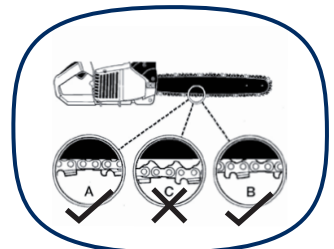

PREPARE



CAUTION! If the saw chain is TOO LOOSE or TOO TIGHT the clutch, chain bar, chain and crank shaft bearing will suffer premature wear. Above fig. shows the correct tension A (when cold) and tension B (when warm). FIG C shows a chain that is too loose.

4. Tighten the chain cover.

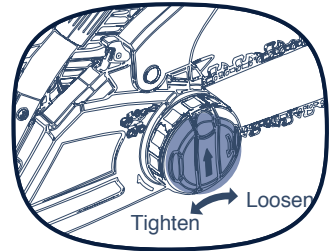

FILLING WITH ENGINE FUEL AND LUBRICATION OIL

This product is powered by a 2-Stroke engine and requires pre-mixing of petrol and 2-stroke oil.

Use a high quality 2-Stroke engine oil according JASO FC classic. Do not use automotive oil or 2-stroke outboard oil. DO NOT mix quantities larger than usable in a 30 day period.

FUEL MIXTURE: petrol: 2 Stroke engine oil = 40:1 ratio.



Note: there are two faces of this bottle one is 40:1, and the other is 25:1, please always use 40:1 for reference.

Using a funnel and keeping the bottle level, pour the petrol firstly in the left hand side (B) up to the required level and pour oil to (A) marking level. Shake vigorously to mix the petrol and oil prior to pouring into the tank(C).

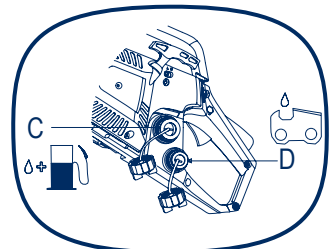
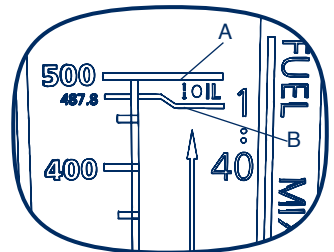

PREPARE

Clean surface around fuel cap to prevent contamination. Loosen fuel cap slowly. Rest the cap on a clean surface. Carefully pour fuel into the tank. Avoid spillage. Prior to fastening the fuel cap, clean and inspect the seal located inside the fuel cap. Immediately replace fuel cap and hand tighten. Wipe up any fuel spillage.



NOTE! It is normal for smoke to be emitted from a new engine after first use.

FILLING THE LUBRICATION OIL

Whenever you refill the fuel tank with petrol you must also top up the level of chain oil in the chain oil reservoir. Use special chainsaw oil to lubricate the saw chain.



NOTE! Most stores will sell acceptable oil under the name "Chainsaw chain oil".



Important! The fuel mix is added into fuel tank(C), chain lubrication oil is filled into oil reservoir(D). Seal one cap prior to removing the second cap. If you put the fluid into the wrong tank seek assistance from an expert immediately.

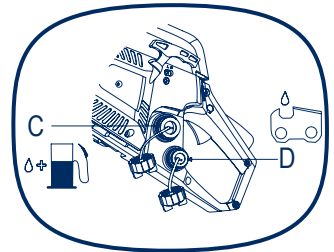

Warning! Lack of chain oil will seriously damage the chain.

OPERATE

START THE ENGINE



WARNING! Do not start the engine whilst holding the chainsaw in one hand. The saw chain may touch your body. This is very dangerous.

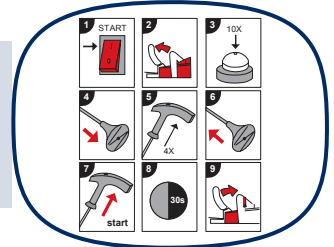

1. Set the switch to the “1” position.

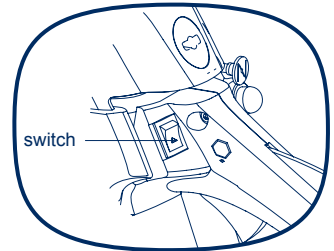
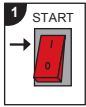

2. Engage the chain-brake (push it forward until an audible click is heard).

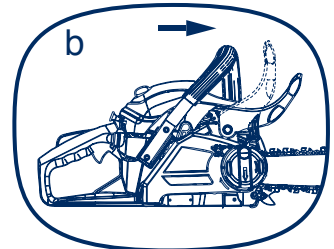

3. Press and release the primer bulb (B) 10 times.

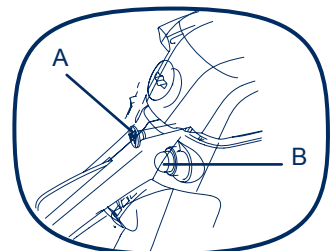
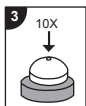

4. Pull the choke control (A) out to engage.



OPERATE

5. While holding the saw unit securely on the ground (one foot fix the rear handle, left hand hold the front handle), pull the start handle four times to warm the engine. At this step, the engine will usually not start.

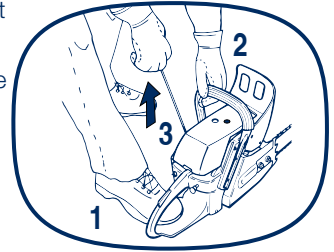

6. Push the choke control (A) in to disengage. (Failure to do this may cause the engine to flood).

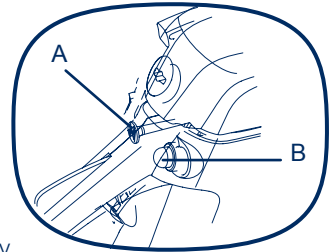

7. Pull the start handle with smooth to start the engine, usually it will start in 5 times.

If the engine does not start, remove the spark plug, dry it with paper towel and replace. Repeat the start procedure. More information, check page 28.

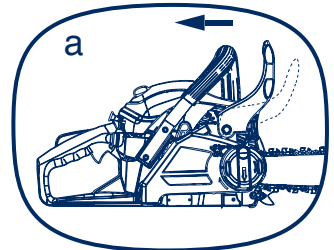

8. After engine starts, allow the saw to run and warm up in this position for 30 seconds.

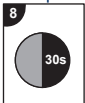

9. Disengage the chain-brake, by pulling it back.

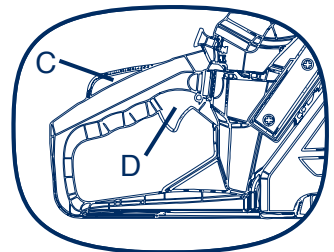

- 10 Push the safety trigger lock (C) firstly and engage the throttle trigger (D).

OPERATE



NOTE! If you fail to start your machine or require further assistance, please contact our after sales support team at 0345 605 2067.

- When restarting immediately after stopping the engine or when the engine is warm, it will not be necessary to use the choke function.

Make sure the cutting blade is pointing away from your body at all times, the chain may rotate upon ignition.

CHECKING THE OIL SUPPLY



NOTE! With the chainsaw fully assembled and adjusted it is important to check the chain oil supply is dispensing adequate lubrication.

After starting the engine, run the chain at medium speed and see if chain oil is being dispensed as fig. shown.

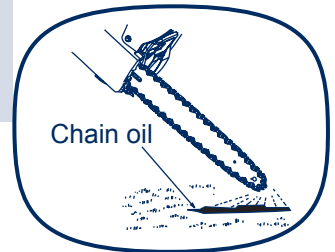

NOTE! The oil reservoir should become nearly empty by the time fuel is used up. Be sure to refill the oil reservoir every time when refueling the saw.

With the chainsaw switched off, the chain oil flow can be changed by inserting a screwdriver in the hole (A) on the bottom of the side of the clutch. Increase or decrease the oil flow according to your work conditions. Restart the chainsaw and check the rate of flow meets your requirements.

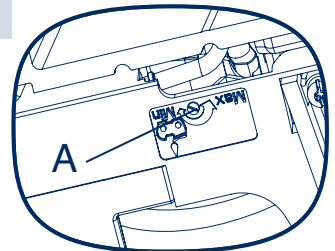

OPERATE

CHECK CHAIN BRAKE

This machine is equipped with a chain-brake that will immediately disable the chain upon the occurrence of kickback during cutting. The brake is automatically operated by inertia forces, which act on the weight fitted inside the front guard. This brake can also be operated manually with the front guard pushed forward to the guide bar. To disengage the chain-brake, pull it back until it touches the front handle.

a= brake disengage

b= brake engage

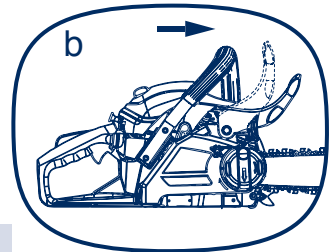
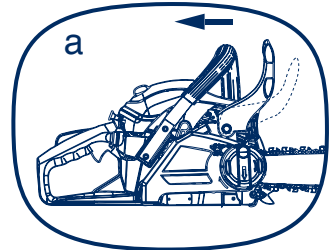

IMPORTANT! Be sure to confirm brake operation every time you use the machine and periodically during the period of use.

HOW TO CONFIRM IF THE CHAIN BRAKE IS FUNCTIONING CORRECTLY

1. Turn off the engine and leave until cold.
2. With the chainsaw on a flat surface and the chain tensioned correctly, engage the chain-brake by pushing it forward until an audible click is heard. Then, wearing protective gloves, attempt to move the chain by hand in the direction of normal rotation if this is not possible the chain brake has been engaged. If the brake is engaged when the chain is rotating at high speed for extended periods of time this can cause damage to the clutch or for it to fail completely. When the brake is activated whilst cutting, immediately release it having first released the throttle lever and set the chainsaw switch to "O". Call service center for more help.

OPERATE

STOP THE ENGINE

1. Release the throttle lever to allow the engine to idle for a few seconds.
2. Set the switch to the “O” position.

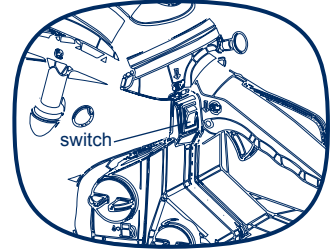

IMPORTANT: Do not put the chainsaw on the ground when it is still running. For additional safety, Switch the chainsaw off when not in use or between cuts. In the event that the ignition switch will not stop the saw, pull the choke control out and engage the chain brake to stop the engine. Call service center.



NOTE! When you have finished using the saw, always relieve the tank pressure by loosening, then retightening, both tank caps. Allow the engine to cool before storing.

OPERATE

SAWING



WARNING! Before proceeding to your job, read the “Safety instructions” section. It is recommended to first practice sawing easy logs. This also helps you get accustomed to your unit. Always follow the safety regulations. The chainsaw must only be used for cutting wood. It is forbidden to cut other types of material. Vibrations and kickback will vary with materials other than wood and the requirements of the safety regulations would not be met. Do not use the chainsaw as a lever for lifting, moving or splitting objects. Do not lock it over fixed stands. It is strictly forbidden to attach any accessories to this product other than those supplied by the manufacturer.

It is not necessary to force the saw into the cut. Apply only light pressure while running the engine at full throttle.

If the saw chain gets caught in the cut, do not attempt to force it out, but use a wedge or a lever to enlarge the cut, freeing the saw.

FELLING A TREE



WARNING! You should have received training from a suitable person before attempting to fell a tree.

When you fell a tree, be sure to warn anyone in close proximity of the danger

1. Decide the felling direction considering the wind, lean of the tree, location of heavy branches, ease of job after felling and other factors.
2. While cleaning the area around the tree, arrange a good foothold and retreat path.

OPERATE

3. Make a notch cut one-third of the way into the tree on the felling side.

4. Make a felling cut from the opposite side of the notch and at a level slightly higher than the bottom of the notch.

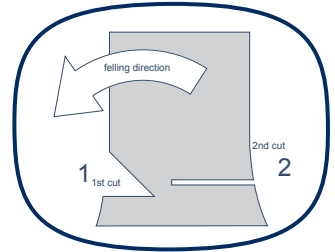

5. Escape path: First clear the tree base and work area of interfering limbs and brush and clean its lower portion with an axe. Then, establish two paths of escape (B) and remove all obstacles. These paths should be generally opposite to the planned direction of the fall of the tree (A) and about at a 45° angle. Place all tools and equipment a safe distance away from the tree, but not on the escape paths.

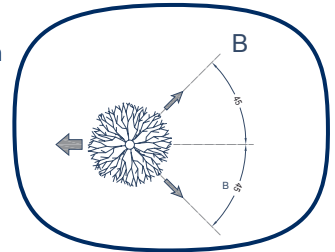

BUCKING AND LIMBING



WARNING!

- Always ensure a stable foothold. Do not stand on the log.
- Be alert to the rolling over of a cut log. Especially when working on a slope, stand on the uphill side of the log.
- Follow the instructions in “Safety Instructions” to avoid kickback of the saw.
- Before starting work, check the direction of the bending force inside the log to be cut. Always finish cutting from the opposite side of the bending

OPERATE

direction to prevent the chain bar from being trapped in the cut.

- Do not use an unstable foothold or ladder.
- Do not overreach.
- Do not cut above shoulder height.
- Always use both hands to grip the saw.

A log lying on the ground.

Saw down halfway, then roll the log over and cut from the opposite side.

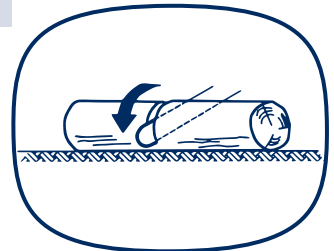

A log supported off the ground.

In area A, saw up from the bottom one-third and finish by sawing down from the top. In area B, saw down from the top one-third and finish by sawing up from the bottom.

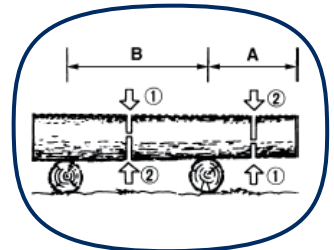

Cutting limb of a fallen tree .

First check to which side the limb is bent. Then make an initial cut from the bend side and finish by sawing from the opposite side.

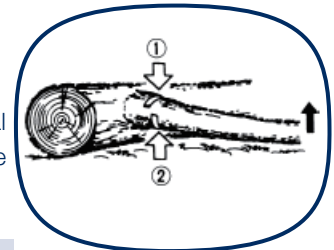

WARNING! Be alert to the spring back of a cut limb.

Pruning of a standing tree.

Cut up from the bottom, finish down from the top.

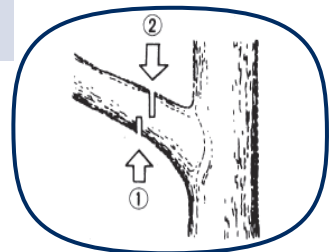

MAINTENANCE

LIST OF VULNERABLE PARTS

Description	Models or specifications
Spark Plug	LD L8RTF/902700
Chain bar	160SDEA041
Saw chain	PJ057X

MAINTENANCE AFTER EACH USE



WARNING! Before cleaning, inspecting or repairing your unit, make sure that the engine has stopped and is cool. Disconnect the spark plug to prevent accidental starting.

1. Air filter

Dust on the air filter surface can be removed by detaching the air filter cover (A), removing the filter and tapping a corner of the filter cover (B) against a hard surface. To clean dirt in the meshes, brush in petrol. When using compressed air, blow from the inside.

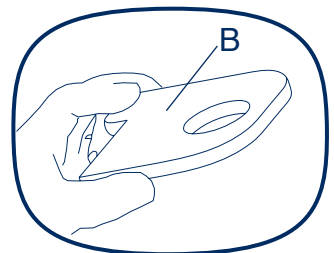
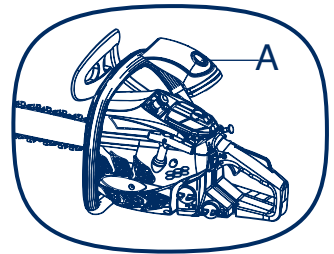

MAINTENANCE

2. Oiling port

Detach the chain bar and check the oiling port (A) for clogging.

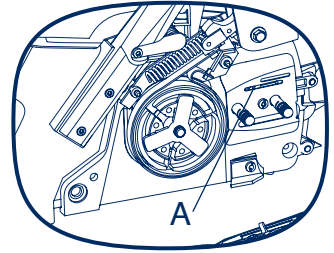

3. Chain bar

When the chain bar is dismantled, remove sawdust from the bar groove and the oiling port.

Grease the nose sprocket through the grease port on the tip of the bar.

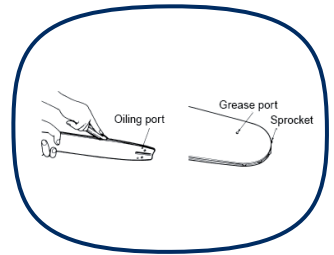

4. To ensure that the saw's engine retains its power, the spark plug must be clean and have the correct electrode gap (0.6 mm). The spark plug (B) must be cleaned or replaced after every 20 hours of service.

- a. Set the On/Off switch to Stop (0).
- b. Remove the top air filter cover.
- c. Disconnect the ignition cable from the spark plug by pulling and twisting it simultaneously.
- d. Remove the spark plug using the supplied spark plug wrench. DO NOT USE ANY OTHER TOOLS.
- e. Clean the spark plug with a copper wire brush and refit it, or fit a new spark plug. Then replace the top cover.

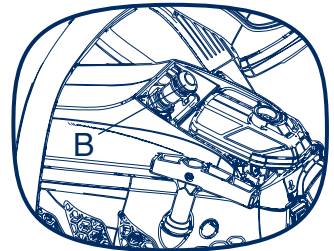

5. Others

Check for fuel leakage and loose fastenings and damage to major parts, especially handle joints and chain bar mounting and Silencer. If any defects are found, make sure to have them repaired before operating the unit again.

MAINTENANCE

HOW TO REPLACE THE CHAIN

1. Pull the chain-brake back and ensure that it has been released. (the chain cover can only be removed with the chain-brake disengaged)

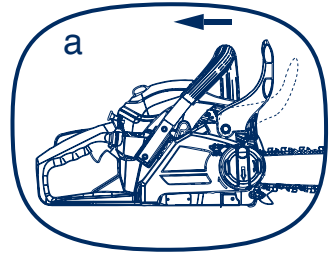

2. Then loosen the chain cover tighten wheel and the chain cover

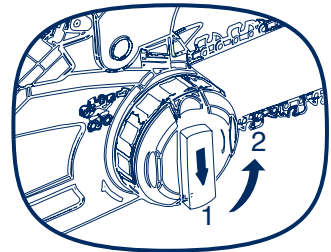

3. Fit the chain around the bar ensuring that the direction of the chain is as depicted in the picture on the bar. Fit the chain on the sprocket. Adjust the position of chain tensioner so the tensioner pin locates in the hole (A) on the bar.

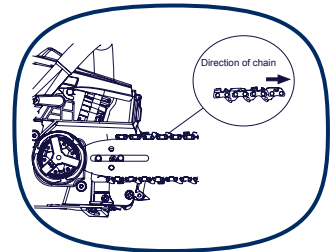

4. Adjust the tension to ensure that there is not too much slack in the chain. Make sure the tensioner pin (B) is located in the assembly hole (A) on the bar. Pay attention to the correct direction of the saw chain. Compare with the picture near the chain sprocket and the picture on the bar.

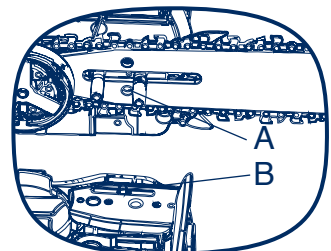

MAINTENANCE

5. Fit the chain cover to the power unit and fasten the nuts to chainsaw and fasten the nuts until finger tight.
6. While holding up the tip of the bar, adjust the chain tension by turning the adjustment wheel until the chain engages in the bar channel. When tensioned correctly it should be possible to pull one full chain link free of the bar channel with ease.
7. Tighten the wheel securely finger tight. Then check the chain for smooth rotation and proper tension while moving it by hand. If necessary, loosen the chain cover.
8. Tighten the tensioner wheel.



NOTE! A new chain will expand its length during the first period of use. Check and re-adjust the tension frequently as a loose chain can easily derail or cause rapid wear of itself and the chain bar.



CAUTION! If the saw chain is TOO LOOSE or TOO TAUT, the clutch, chain bar, chain and crank shaft bearing will suffer premature wear, above FIG shows the correct tension A (when cold) and tension B (when warm). FIG C shows a chain that is too loose.

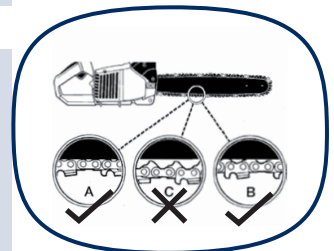

MAINTENANCE

PERIODICAL SERVICE POINTS

1. Start assembly
2. Fan cover
3. Fan
4. Cylinder fins
5. Engine cover

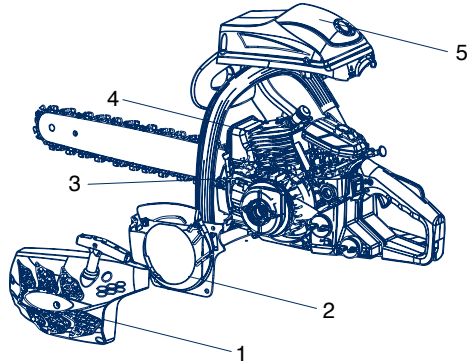

Air cooling system

Dust clogging around the cooling system and the cylinder fins will cause overheating of the engine. Periodically check and clean the cooling system and the cylinder fins with a brush after removing the cylinder cover, the air cleaner and the recoil case. When installing the cylinder cover and the cooling system, make sure that switch wires and grommets are positioned correctly in place.



NOTE! Be sure to unblock the air intake hole.

MAINTENANCE

MAINTENANCE OF THE SAW CHAIN AND CHAIN BAR

NOTE! It is very important for smooth and safe operation to always keep the cutters always sharp.

The cutters need to be sharpened when:

1. Sawdust becomes powder-like.
2. Cutting requires extra force.
3. The chainsaw does not cut straight and clean.
4. Vibration increases.
5. Fuel consumption increases.

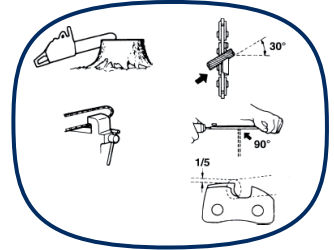

Cutter setting guidance

WARNING! Be sure to wear safety gloves.

Before filing:

1. Make sure the saw chain is held securely.
2. Make sure the engine is stopped.
3. Use a round file with the proper size for your chain

Note: Chain type: 91PJ File size: 5/32 in (4.0 mm)

Place your file on the cutter and push straight forward.
Position the file position as illustrated.

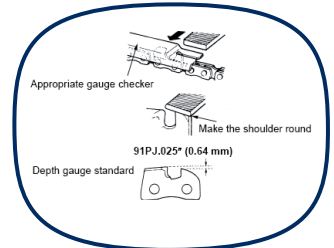

After every cutter has been set, check the depth gauge and file it to the proper level as illustrated.

Make sure every cutter has the same length and angle as illustrated.

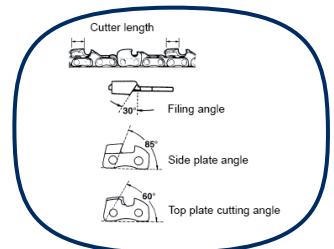

MAINTENANCE

Chain Bar

1. Reverse the bar occasionally to prevent partial wear.
2. The bar rail should always have parallel internal faces (see diagram). Check for wear of the bar rail. Apply a ruler to the bar and the outside of a cutter. If a gap is observed between them, the rail is normal. Otherwise, the bar rail is worn. Such a bar needs to be corrected or replaced.

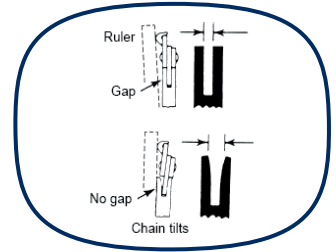

TECHNICAL DATA

Model	CS4100-3
Engine displacement	41cm ³
Engine	1.5kW
Bar length	40 cm
Chain gauge	(0.050'), 1.27 mm
Idling speed	3300±300 /min
Maximum speed with cutting equipment	11000 /min
Max chain speed	21 m/s
Fuel tank capacity	260 ml
Oil tank capacity	210 ml
Anti-vibration function	Yes
Chain wheel teeth	6 Teeth x 9.255 mm
Chain brake	Yes
Clutch	Yes
Automatic chain lubrication	Yes
Low-kickback chain	Yes
Net weight without chain and chain bar	4.5 kg
Net weight (dry)	6 kg
Fuel consumption (specific)	702g / kWh
LpA sound pressure level	99 dB(A) K=3 dB(A)

TECHNICAL DATA

LWA sound power level	114 dB(A)
Vibration ahv (front handle) max.	6.5 m/s ² K=1.5 m/s ²
Vibration ahv (rear handle) max.	6 m/s ² K=1.5 m/s ²

The sound intensity level for the operator may exceed 80 dB(A) and ear protection measures are necessary.

The declared vibration value has been measured in accordance with a standard test method and may be used for comparing one product with another. The declared vibration value may also be used in a preliminary assessment of exposure.



WARNING! Depending on the actual use of the product the vibration values can differ from the declared total! Adopt proper measures to protect yourself against vibration exposures! Take the whole work process including times the product is running under no load or switched off into consideration! Proper measures include among others regular maintenance and care of the product and cutting attachments, keeping hands warm, periodical breaks and proper planning of work processes!

TROUBLESHOOTING

CAUTION!

- Always switch off the engine and pull the ignition cable before starting any inspection or adjustment work.
- If, after making an adjustment or repair to the engine, you let it run for a few minutes, remember that the exhaust and other parts will get hot. Thus, do not touch parts that emanate heat, as these may burn you.

The following table provides solutions to common problems encountered with the chainsaw.

Fault	Possible Cause	Solution
Unit won't start or starts but will not run	<ol style="list-style-type: none">1. Incorrect starting procedures2. Incorrect carburetor mixture adjustment setting3. Fouled spark plug4. Fuel filter blocked5. Chain brake is engaged	<ol style="list-style-type: none">1. Follow instructions in the User Guide or refer to the starting procedure check list on page 142. Have carburetor adjusted by an Authorised Service Centre3. Clean/gap or replace plug4. Replace fuel filter5. Pull Chain brake in disengage position
Unit starts, but engine has low power	<ol style="list-style-type: none">1. Incorrect lever position on choke2. Dirty air filter3. Incorrect carburetor mixture adjustment setting	<ol style="list-style-type: none">1. Move to RUN position2. Remove, clean and reinstall filter3. Have carburetor adjusted by an Authorised Service Centre
Engine hesitates	<ol style="list-style-type: none">1. Incorrect carburetor mixture adjustment setting	<ol style="list-style-type: none">1. Have carburetor adjusted by an Authorised Service Centre
No power under load	<ol style="list-style-type: none">1. Incorrectly gapped spark plug	<ol style="list-style-type: none">1. Clean/gap or replace plug
Runs erratically	<ol style="list-style-type: none">1. Incorrect carburetor mixture adjustment setting	<ol style="list-style-type: none">1. Have carburetor adjusted by an Authorised Service Centre

TROUBLESHOOTING

Smokes excessively	1. Incorrect fuel mixture	1. Use properly mixed fuel (40:1 mix)
Poor performance when operated	1. Blunt chain 2. Loose chain	1. Sharpen or replace the chain 2. Tension the chain
Engine dies	1. Empty petrol tank 2. Fuel filter in the wrong position in the tank	1. Fill up the petrol tank 2. Completely fill the petrol tank or reposition the fuel filter in the petrol tank
Insufficient chain lubrication (the cutter rail and chain get hot)	1. Empty oil tank for the chain 2. Oil lubrication opening blocked	1. Top up the oil tank for the chain 2. Clean the oil lubrication hole in the cutter bar Clean the groove in the cutter bar

WARRANTY

If your device develops a fault, please don't hesitate to contact our customer service department on 0345 605 2067, we can solve 80% of problems via the phone.

1. These warranty terms cover additional warranty rights and do not affect your statutory warranty rights. All our products are covered by a 3 year manufacturer warranty.
2. Claims must be accompanied by proof of purchase. This must be in the form of a sales receipt or bank statement and must show that the product has been purchased within the warranty period as described under point 1, from the retailer that it was originally bought from. Please keep your receipt safe or staple it to the back of this manual for future reference.
3. Our warranty covers problems caused by material or manufacturing defects, and will result in the repair of these defects or replacement of the device with a like for like or similar article.
4. Our devices have not been designed for commercial, trade or industrial applications, any signs of use of the equipment in these application or equivalent activities, invalidates the warranty.
5. The following are also excluded from our warranty:
 - A. Faults due to accidents, customer misuse or unauthorized repairs
 - B. Consumable Parts such as cutting line, plant protectors, handles, knobs, extension cable and other accessories that are compatible with the product.
 - C. Failure due to lack of routine maintenance.
 - D. Failure as a result of not using the equipment in accordance with the manual and safety instructions
 - E. The adjustment of carburetor, spark plug or switches.

Warranty claims should be submitted before the end of the warranty period, see point 1, but a paid service exists for repairs commissioned after this period. The original warranty period remains applicable to the device even if repairs are carried out or parts are replaced. In such cases, the work performed or parts fitted will not result in an extension of the warranty period, and no new warranty will become active for the work performed or parts fitted.

If you have any problems or questions concerning your garden power tool, please contact our after sales service at 0345 605 2067.

This device may be re-conditioned, like for like or upgraded replacement.