

3x3M Pop Up Gazebo

Assembly Instructions - Please keep for future reference

764/3680



Dimensions

Width - 300cm

Depth - 300cm

Height - 250cm



Important: This Gazebo Must be opened, erected and dismantled by 2 people at least



Important: Make sure all the guy ropes and pegs are used, otherwise the gazebo will be unstable!

Important – Please read these instructions fully before starting assembly

If you need help or have damaged or missing parts, call the

Customer Helpline: Argos = 0345 6400800

For further assistance please visit <http://www.argos-support.co.uk>

Address: 489-499 Avebury Boulevard Saxon Gate West, Central Milton Keynes Bucks, MK9, 2NW



IMPORTANT SAFETY INSTRUCTIONS

Read all instruction before using and keep for future reference

- Read these instructions carefully and familiarise yourself with the procedure before assembling the unit.
- Check that you have all the component parts following the list on the page 3 and familiarise yourself with each part before proceeding.
- Take all the fittings out of the plastic bag and separate them into their groups.
- Ensure you have enough space to lay out all the parts before assembly.
- To avoid scratching it is recommended that you assemble the unit on a soft level surface.
- Please keep children away when assembly. Please keep children under direct supervision of adult when using.
- **Please do not use the gazebo under windy condition.**
- Always use guy rope and pegs to secure the gazebo when using.
- This Gazebo is not a permanent structure and should be disassembled and stored away after using.
- Do not repack your Gazebo until completely dry.
- This gazebo is not waterproof.
- We recommend assembly by four persons under light or no wind conditions.
- This Gazebo must not be left erect in windy conditions.
- Keep the Gazebo Fabric away from screws, nails, staples, hooks, etc to avoid damage to the fabric and frame.
- **Warning:** The unit weights approximately 10.5 kgs.
- **Please lift with care.**

CAUTION

Fire precautions

- Do not place the Gazebo near lights, fireplaces, gas or electric heaters, candles, radiators, or any other sources of heat, fire or flammable liquids.
- This Gazebo features a Fabric cover that is not flame retardant.
- We recommend caution and common sense when in use.
- This Gazebo can burning.
- Do not use naked flames in or around the Gazebo. We recommend you advise no smoking while inside.
- This Gazebo has no flame retardant cooking area and should not be use to house BBQs or other cooking methods.

Safety

- To avoid any risks of suffocation to animals or children dispose of the plastic bags immediately.

Cleaning





- As with all surfaces clean with a damp cloth and mild detergent, do not use bleach or abrasive products.

Components - Parts & Fittings

If you have damaged or missing components, call the Customer Helpline: Argos = 0345 6400800

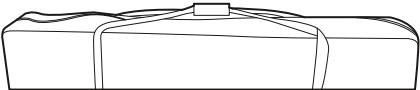
Please check you have all the parts & fittings listed below

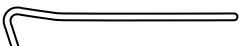
Note: The quantities below are the correct amount to complete the assembly. In some cases more fittings may be supplied than are required.

<p>1</p>  <p>Tent bag x 1</p>	<p>2</p>  <p>Gazebo x 1</p>	<p>A</p>  <p>Peg x 8</p>
<p>B</p>  <p>Guy rope x 4</p>		

Tools required

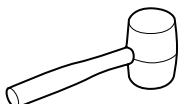

D Rubber mallet x 1

Assembly Instructions

Step 1

Opening the Gazebo

Note: At least 2 people are required for this procedure.

a & b: Stand the Gazebo **2** upright.

With people at diagonally opposite corners, carefully pull the Gazebo partly open.

Move to each side, carefully pulling the frame apart until it has expanded as shown in diagram b.

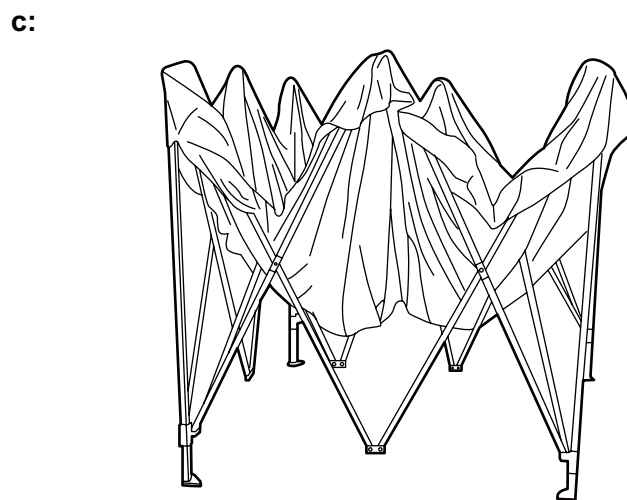
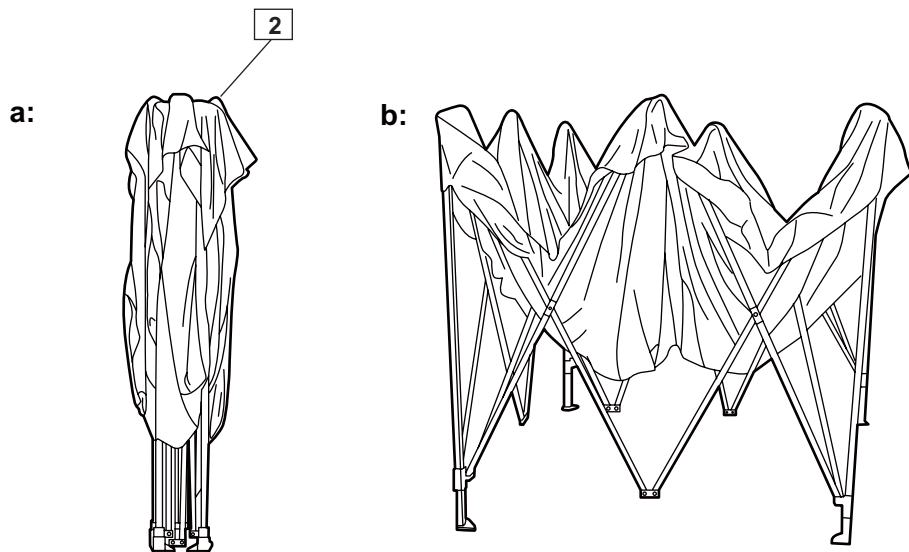

d:

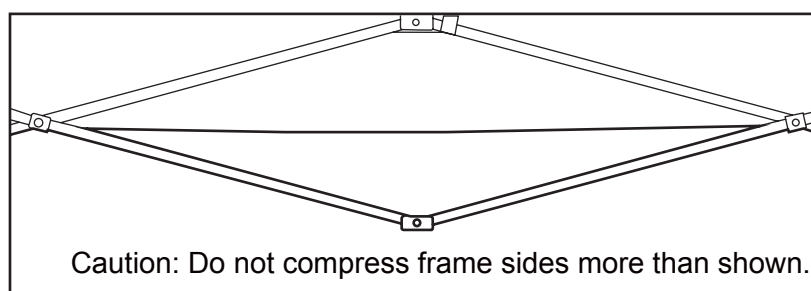

Step 2

c & d: Lift the canopy to reveal the framework.

With people at opposite sides, carefully push up and down on the frames where shown.

Move to each side, carefully pulling (compressing) the frame together until it has expanded as showed in diagram d.

Assembly Instructions

Step 3

Locking and extending the Gazebo frame

Note: At least 2 people are required for this procedure.

a: In one corner at a time, lock the Gazebo frame **2** in position by sliding the corner bracket up until the spring clip engages into the bracket.

Pull and extend each leg until the spring clips engage into the hole in the outer tubes.

Note: There are two spring clip location holes in each leg, using the lower holes will increase the canopy tension, pulling it tighter.

b: Use the velcro tapes top frame as shown

c: From inside, check that of the frame sides are as shown.

Note: each velcro tap frame are as shown.

- ① stretch the tap first
- ② stick velcro tap second

Warning: the velcro tap must stretch tight as this could cause rain water to collect on the canopy and a hazard.

Do not compress more than shown or the frame can be damaged.

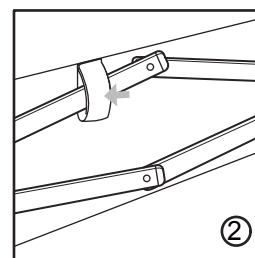
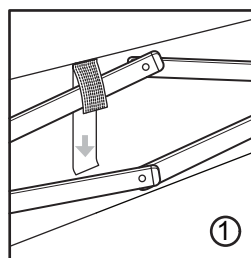
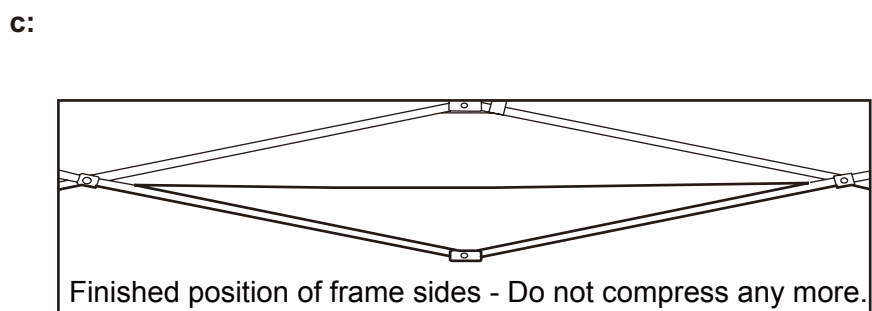
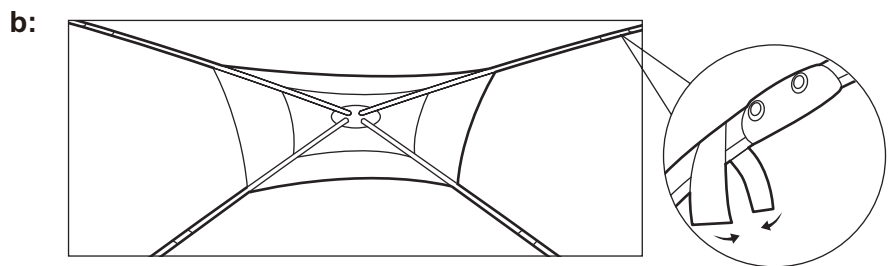
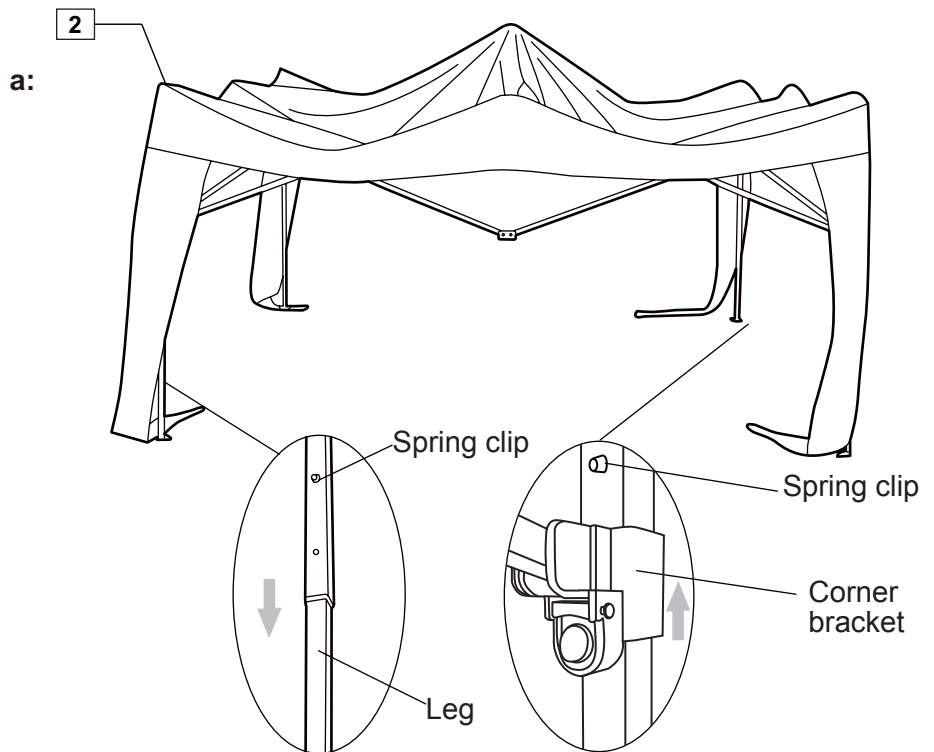

Assembly Instructions

Step 4

Fitting the legs

a: Secure the gazebo **2** to the ground at each corner, Insert two pegs **A** through the hole in each Frame leg into the ground (insert at an angle).

Take care not to bend the pegs, use a rubber mallet to help Insert if required.

b: Attach the hooks on the end of the canopy legs to the holes at the end of the frame leg, the canopy cover can be tightened by moving the hooks to a lower Hole.

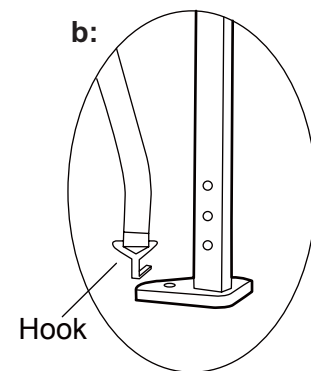
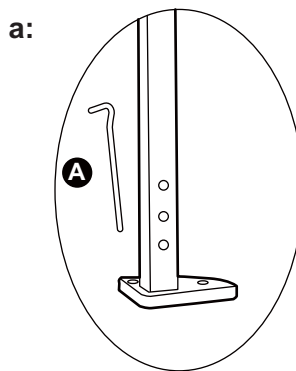
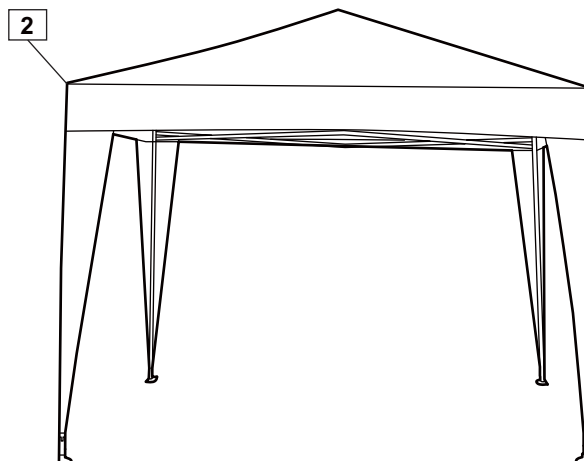

Step 5

Attaching the guy ropes

Note: At least 2 people are required for this procedure.

a: Attach the end of each guy Rope **B** to a "D" ring at each corner of the canopy cover.

b: Use the pegs **A** to secure the other end of the guy rope to the ground (insert at an angle).

Remove any slack from the Guy rope by holding the lower end of the rope and sliding the tensioner up towards the tent.



Caution:

Do not over tighten the Guy ropes as this can damage the fabric seams.

The assembly is now complete

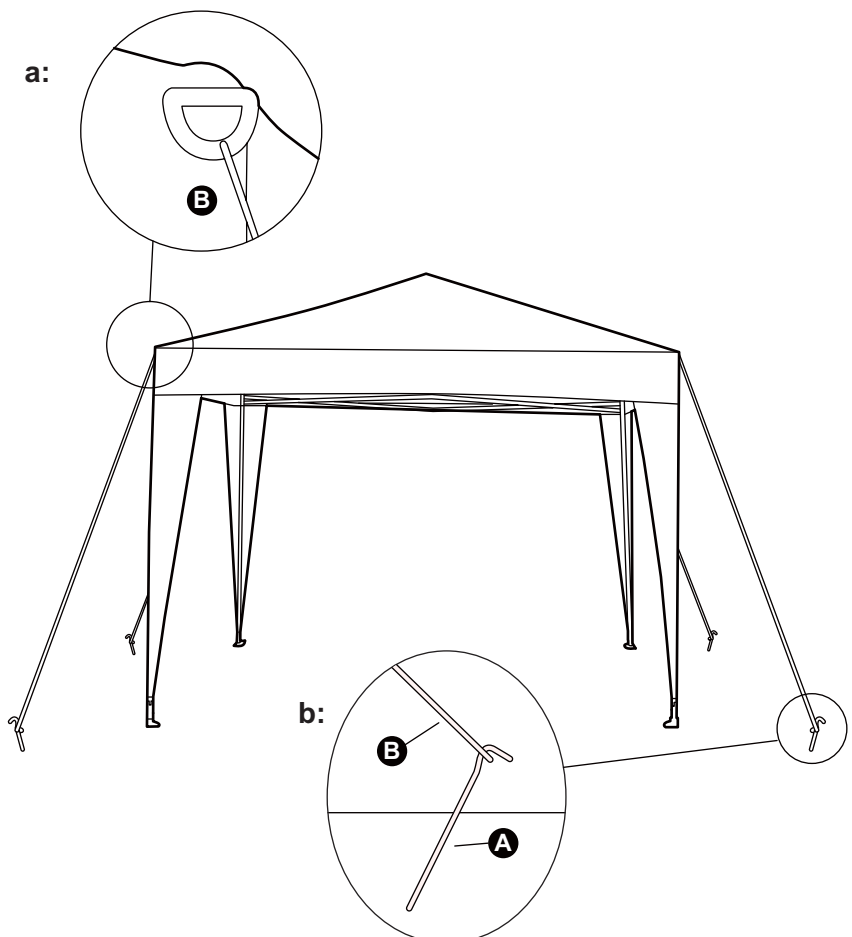

Folding Instructions

Step 6

Folding the Gazebo

Note: At least 2 people are required for this procedure.

Take care when dismantling the Gazebo. Follow the assembly instructions in the reverse order and do not force the frame.

a: Remove the guy ropes and pegs

b: Unhook the canopy from the frame legs and remove the pegs

c: Push in the spring clips and slide up the frame legs

d: Push in the button and (slightly) lower the corner brackets.

e: With people at diagonally opposite corners, carefully lift and push the gazebo together.

Do not force the frame.

Repeat at each corner until the gazebo is fully folded.

Store all of the components and fittings in the tent bag **1** provided.

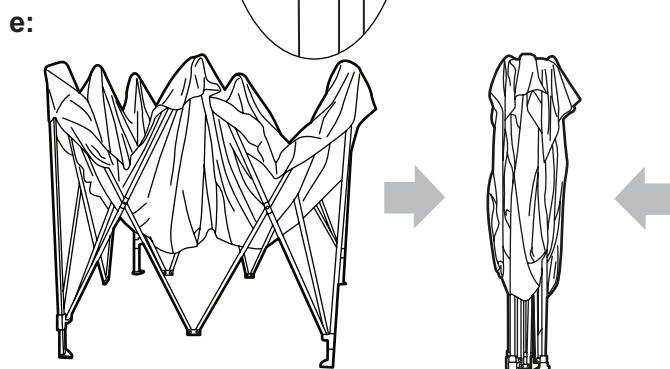
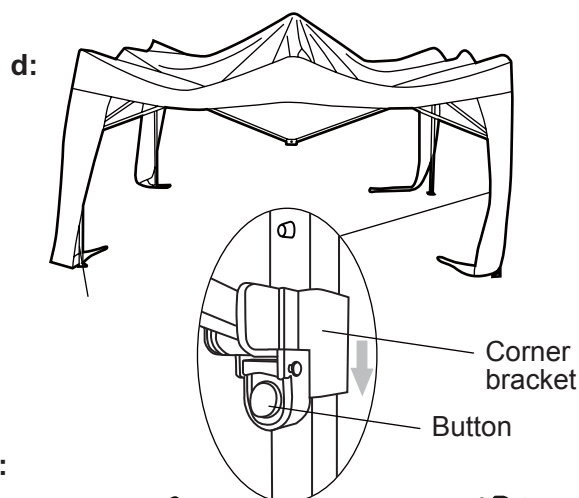
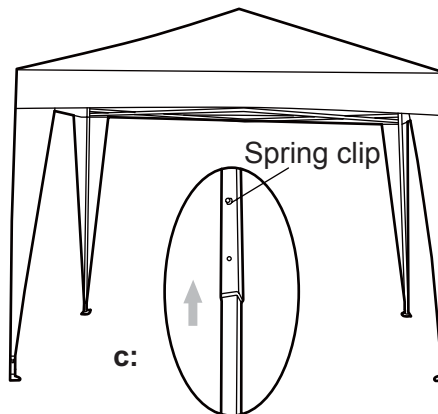

Warning: Please do not erect or use this gazebo in high winds

If you need help or have damaged or missing parts, call the

Customer Helpline: Argos = 0345 6400800

For further assistance please visit <http://www.argos.support.co.uk>

Address: 489-499 Avebury Boulevard Saxon Gate West, Central Milton Keynes Bucks, MK9, 2NW