



**SPEAR &
JACKSON**

ORIGINAL INSTRUCTION MANUAL

40cm hand push

Cylinder Lawnmower

S40HC



**Important - Please read these instructions
fully before starting assembly**

These instructions contain important information that will help you get the best from your mower, ensuring it is assembled correctly and safely. If you need help or have damaged or missing parts, call the Customer Helpline on 0345 605 2067

**AFTER SALES SUPPORT
0345 605 2067**

SPEAR & JACKSON SINCE 1760

For more than 250 years gardeners have enjoyed high quality performance and great results using Spear & Jackson tools.

Our garden power tools combine continuous innovation and the latest in manufacturing technologies with a proud heritage.

Each product is carefully designed with performance, comfort and durability firmly in mind, which has earned Spear & Jackson an enviable reputation as a maker of tools to trust.

3 YEARS GUARANTEE

As a testament to the quality of our products, we offer a 3 year manufacturers warranty and a comprehensive after sales service.

The warranty covers manufacturing faults, however in the event that the item has been deliberately damaged, used in a commercial environment or disassembled then the warranty will be null and void.

Please retain proof of purchase.

7 DAYS A WEEK TECHNICAL SUPPORT

We want you to get the best out of your products. Our easy-to-read instruction manual guides you with best practice use and maintenance tips. Please call **0345 605 2067** for technical support, we can solve around 80% of questions directly over the phone.

We hope you enjoy your product and we look forward to any feedback, as this allows us to develop even better products for the future.

CONTENTS

Safety Information.....	04
Description of symbols.....	04
General safety.....	05
Personal safety.....	05
Operate safety.....	07
Maintenance and storage safety.....	08
Intended use.....	09
Box Content / Parts.....	10
Assemble.....	11
Unpacking.....	11
Attaching the handle.....	11
Attaching the grass collection box.....	12
Operate.....	13
Adjusting the cutting height.....	13
Operating the hand push mower.....	13
Maintenance	14
Technical Data.....	18
Troubleshooting.....	19
Warranty.....	20

SAFETY INFORMATION

Please read these instructions fully before operating or maintaining your machine.

DESCRIPTION OF SYMBOLS

The following warning symbols appear throughout this manual and indicate the appropriate safety measures you should take when operating and maintaining your lawnmower.



Warning.



Read the instruction manual.



Wear gloves protection.



Wear proper safety shoes.



Wear eye protection.



Keep bystanders away. Thrown objects can cause serious injury.



Caution-sharp cutting blade! Keep feet and hands away. Risk of injury.



Caution! Risk of injury by rotating blade! Keep hands and feet away from the openings when operating the mower.

SAFETY INFORMATION

Please read these instructions fully before operating or maintaining your machine

GENERAL SAFETY

WARNING!

- Keep this operating and maintenance manual in a safe place for future reference.
- Read the instructions carefully. Be familiar with the controls and the proper use of the equipment.
- Never mow while people, especially children, or pets are nearby. Keep in mind that the operator or user is responsible for accidents or hazards occurring to other people or their property.
- This appliance is not intended for use by persons (including children) with reduced physical, sensory or mental capabilities or lack of experience and knowledge, unless they have been given supervision or instruction

concerning use of the appliance by a person responsible for their safety.

- Do not touch the rotating blades.

PERSONAL SAFETY

WARNING!

- This machine can cause serious injuries. Read the instruction carefully for the correct handling, preparation, maintenance, using of the appliance. Be familiar with the controls and the proper use of the appliance. Read and understand the operator's manual and observe the warnings and instruction labels affixed to the machine.
- Users. Never allow children or people unfamiliar with these instructions to use the machine. Local

SAFETY INFORMATION

Please read these instructions fully before operating or maintaining your machine

regulations may restrict the age of operator. Never operate the tool under the influence of alcohol, medication or drugs.

- This product is intended for private use only, not for any commercial applications. It may not be used for any purposes other than those described.
- Use personal protective equipment(PPE). Always wear eye protection. Protective equipment such as dust mask, non-skid safety shoes or gloves used for appropriate conditions will reduce personal injuries.
- Dress appropriately. Do not wear loose clothing or jewelry, as these can be caught in moving parts. Preferably wear non-slip footwear when working outdoors. Wear protective hair covering to keep long hair out of the way.

- Stay alert, watch what you are doing and use common sense when operating the tool. A lapse of concentration while operating the tool may result in serious personal injury.
- Keep all parts of the body away from the cutter blade. Do not remove cut material or hold material to be cut when blades are moving. Make sure the blade is stopped when clearing jammed material. A lapse of concentration while operating the tool may result in serious personal injury.
- Do not overreach. Keep proper footing and balance at all times. This enables better control of the tool in unexpected situations.
- Keep all bystanders, children, and pets at least 50 feet away. The operator or user is responsible

SAFETY INFORMATION

Please read these instructions fully before operating or maintaining your machine

for accidents or hazards occurring to other people or the property.

OPERATE SAFETY

WARNING!

- Be certain the parts are fully tightened before operating the machine. Check it periodically for tightness during use to avoid serious injury.
- Check for damaged parts. Before further use, carefully check the tool for damage. Check for alignment of moving parts, binding of moving parts, breakage of parts, mounting and any other condition that may affect its operation. Do not use the tool if any parts are damaged or defective. Have any damaged or defective parts repaired or replaced by an authorized service agent. Never

attempt any repairs yourself.

- Grip the tool securely. Operator should both hands on the main handle while operating the tool.
- Never operate the mower in wet grass. Always be sure of your footing. A slip and fall can cause serious personal injury.
- Mow only in daylight or good artificial light. Walk, never run. Be careful when pulling the machine backward. Look down and behind to avoid tripping. Be sure you are well balanced with sure footing.
- Risk of cut. The cutting blade may continue to rotate for a few seconds after the mower has stopped moving. Never place any part of the body in the blade area until you are sure the blade has stopped rotating.
- Keep work areas clean.

SAFETY INFORMATION

Please read these instructions fully before operating or maintaining your machine

MAINTENANCE AND STORAGE

Cluttered areas and benches can cause accidents.

- Consider work area environment. Do not expose your tool to high humidity or rain. Do not use your tool in damp and wet conditions. Keep the work area well lit.
- Mow across the face of slopes; never up and down. Be cautious when changing direction on slopes.
- Watch for holes, tree roots, rocks, hidden objects or bumps which can cause you to slip or trip. Tall grass can hide obstacles.
- Always be sure of your footing. A slip and fall can cause serious personal injury.

WARNING!

- Maintain tools with care. Keep tools clean and in good condition for better and safer performance. Follow the instructions for maintenance.
- Keep cutting blades sharp and clean. Properly maintained cutting blades with sharp cutting edges are less likely to bind and easier to control. Wear gloves, and use extra caution when maintenance.
- Store idle tool out of the reach of children and do not allow persons unfamiliar with the power tool or these instructions to operate the tool. Tool is dangerous in the hands of untrained users.

SAFETY INFORMATION

Please read these instructions fully before operating or maintaining your machine

INTENDED USE

- This product is intended for cutting grass and similar soft vegetation in private and hobby garden areas. The device is not to be used in public gardens, parks, sports centres or at roadsides as well as agriculture and forestry trimming hedges, bushes and shrubs.
- This product is intended for private use only, not for any commercial applications. It may not be used for any purposes other than those described.
- Children should be supervised to ensure that they do not play with the product.

BOX CONTENTS

PARTS

- | | |
|-------------------------------|------------------------------|
| 1 Mower body | 7 Wheel |
| 2 Mid handle x 2pcs | 8 Blade |
| 3 Upper handle with foam grip | 9 Height adjustment wing nut |
| 4 Lower handle | |
| 5 Handle fix bolts X 6 pcs | |
| 6 Grass box | |

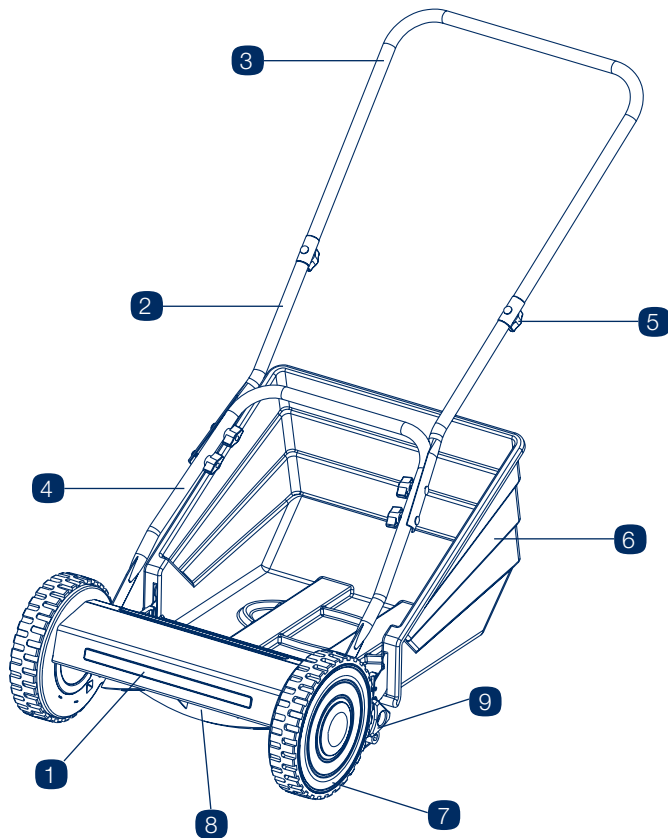

If there are any parts missing, please call the customer helpline on **0345 605 2067**

ASSEMBLE



WARNING! Wear proper gloves!

1 Unpacking

- Unpack all parts and lay them on a flat, stable surface.
- Remove all packing materials and shipping devices if applicable.
- Make sure the delivery contents are complete and free of any damage. If you find that parts are missing or show damage do not use the product but contact the aftersales service within 28 days of purchase. Using an incomplete or damaged product represents a hazard to people and property.
- Ensure that you have all the accessories and tools needed for assembly and operation. This also includes suitable personal protective equipment.

2 Attaching the handle

- Secure the upper handle (A) to the mid handles (B) with two fix bolts.
- Secure the mid handle to lower handle (C) with four fix bolts.
- Position the complete assembled handle over the studs of both sides on the rear of mower frame.

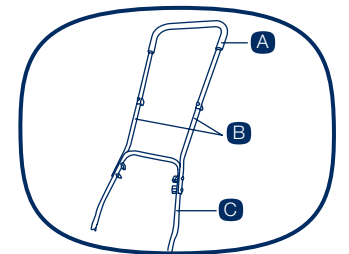

ASSEMBLE

3 Attaching the grass collection box

Place the grass box onto two hooks on machine.

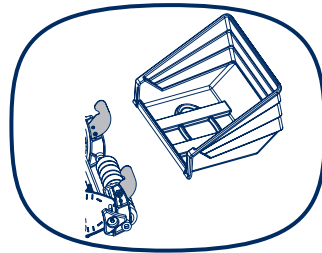

OPERATE

1 Adjusting the cutting height

Cutting height has been set in the 30mm position when packed. If need adjust the cutting height, loose wing nut (A) which located on both sides of the mower. Move roller brackets (B) to the desired height of cut.

- Tighten the wing nut.

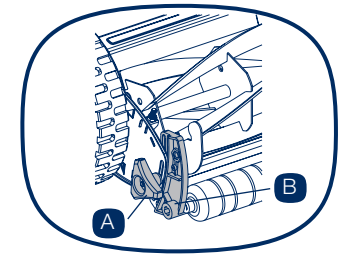

2 Operating the hand push mower

i. Do not cut wet grass because it tends to stick to the underbody of the product, preventing the proper discharge of grass clippings, and it could also cause you to slip and fall.

ii. Never cut off more than one-third of the total length of the grass for a healthy lawn. In the autumn, lawns should only be cut as long as there is growth.

iii. Slowly push the product forward.

iv. Mow in slight overlapping rows. The most effective pattern for mowing lawns is straight lines along one of the sides. This will keep the rows even and ensures that all the lawn is cut without missing any spots.

v. Circle around flower beds. When reaching a flower bed in the middle of the lawn, cut a row or two around the circumference of the bed.

vi. Pay special attention when changing direction.

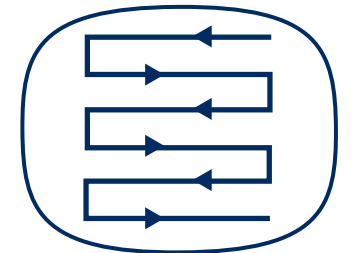

MAINTENANCE

Maintenance and Repair



WARNING!

Cylinder mowers have a difficult time with tall weeds such as dandelions which most times will cause the weeds to bend and not cut – cut often to prevent this.

Cylinder mowers are relatively low maintenance. For consistent cutting follow the below instructions:

- Always keep the cutting bar properly adjusted. Refer to the instruction manual for further directions.
- Regularly clean and lubricate the cutting edges with light spray oil.
- Keep area to be mowed free from debris to avoid damage of the cutting blades.
- For best results, regularly apply lubricant to mower's cutting surfaces, cutting reel axle shaft and wheels.
- Turn the Cylinder blades until the front edge of the cutter bar blade is polished.

MAINTENANCE

Blade clearance adjustment



WARNING!

- Mower blade are sharp and can cut. Wear gloves and use extra caution when servicing them. Any wheel rotation can cause the blade reel to rotate.
- Do not over-tighten adjustment screw as this could damage cutter bar. Both screws must be tight on final adjustment.

The blade reel is adjusted for proper clearance from the cutting bar at the factory. However, after extended periods of mowing or as part of annual maintenance, it is recommended that the blade clearance be readjusted .

- If blade clearance is too wide, the cutting pattern will be rough and uneven.
- If blade clearance is too narrow, the machine will be noisy and difficult to push while operating.

To adjust blade clearance, proceed as follows:

- Turn mower upside down.
- Insert a piece of paper(thickness around 0.12mm) between cutter bar and reel blades, and slowly turn wheel by hand.
- All blades should slice the paper evenly, along the entire length of the cutter bar while the reel turns smoothly.
- If mower has an intermittent cut, adjustment should be made to the appropriate side of blades to attain proper cutting action. We've taking sharpening the cutting blade out due to health and safety issues.
- Tighten the screws on both side of the fixed blade, ensure that the blade can cut the paper easily.

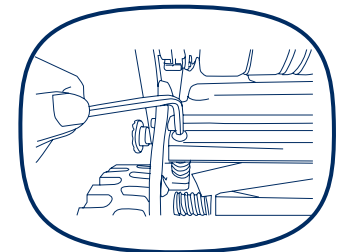
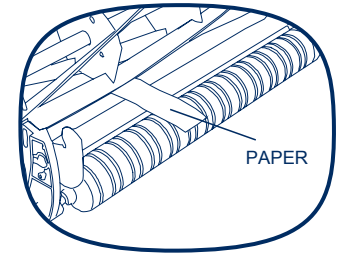

MAINTENANCE

Storage and transportation



WARNING!

Do not place hands in the mower near blades. If grass cuttings are compacted in the blade area, remove using a wood or plastic cleaning tool appropriate for the cleaning of the blades.

1. Clean the exterior of the machine thoroughly using a soft brush and cloth before storing. Do not use water, solvents or polishes.
2. Turn the mower on its side to clean the blade area.
3. Store the mower in a dry place. Do not place other objects on top of the mower during storage.

Recycling and disposal

1. Recycle unwanted materials instead of disposing of them as waste. All tools, hoses and packaging should be sorted, taken to the local recycling centre and disposed of in an environmentally safe way.
2. Recycle rather than dispose of unwanted material in landfill whenever possible. The machine must be delivered in rigid packaging to avoid damage during transportation. The packaging and the machine itself are manufactured from recyclable materials and should be disposed of accordingly.
3. Do not throw your clippings into a rubbish bin where it will be disposed of in landfill. You can dispose of clippings on your compost heap, alternating then with other garden material. The more thoroughly you chop the clippings beforehand, the more rapidly they will degrade. Alternatively, many communities provide a public collection point where you

MAINTENANCE

can dispose of your garden waste in an environmentally friendly manner.

4. Only dispose of electrical/electronic/battery items in separate collection schemes, which cater for the recovery and recycling of materials contained within. Your cooperation is vital to ensure the success of these schemes and for the protection of the environment.
5. Recycle packaging where facilities exist.

TECHNICAL DATA

Model	S40HC
Cutting width	400mm
Variable cutting heights	15-42mm
Grass collection box Volume	30litres
Weight	8kg

TROUBLESHOOTING

Suspected malfunctions are often due to causes that the user can fix themselves. Therefore, check the product using this section. In most cases the problem can be solved quickly.



WARNING! Only perform the steps described within these instructions! All further inspection, maintenance and repair work must be performed by an authorised service centre or a similarly qualified specialist if you cannot solve the problem yourself!

Problem	Possible Cause	Solution
Unsatisfying cutting result	Blade clearance is too wide	Adjust the blade clearance, refer to maintenance section
Machine is too noisy and difficult to operate	Blade clearance is too narrow	Adjust the blade clearance, refer to maintenance section

WARRANTY

If your device develops a fault, please don't hesitate to contact our customer service department on 0345 605 2067, the majority of problems can be solved directly on the phone.

1. These warranty terms cover additional warranty rights and do not affect your statutory warranty rights. All our products are covered by a 3 year manufacturer warranty.
2. Claims must be accompanied by proof of purchase. This must be in the form of a Sales receipt or bank statement and must show that the product has been purchased within the warranty period as described under point 1, from the retailer that it was originally bought from. Please keep your receipt safe or staple it to the back of this manual for future reference.
3. Our warranty covers problems caused by material or manufacturing defects, and will result in the repair of these defects or replacement of the device with a like for like or similar article.
4. Our devices have not been designed for commercial, trade or industrial applications, any signs of use of the equipment in these application or equivalent activities, invalidates the warranty.
5. The following are also excluded from our warranty:
 - A. Faults due to accidents, customer misuse or unauthorized repairs
 - B. Consumable Parts such as blades, quick release locks, extension cables, wheels, grass bags and other accessories that are compatible with the product.
 - C. Failure due to lack of routine maintenance.
 - D. Failure as a result of not using the equipment in accordance with the manual and safety instructions

Warranty claims should be submitted before the end of the warranty period, see point 1, but a paid service exists for repairs commissioned after this period. The original warranty period remains applicable to the device even if repairs are carried out or parts are replaced.

In such cases, the work performed or parts fitted will not result in an extension of the warranty period, and no new warranty will become active for the work performed or parts fitted.

If you have any problems or questions concerning your garden power tool, please contact our after sales service at 0345 605 2067.