



ORIGINAL INSTRUCTION MANUAL



McGregor 350W/450W/600W Grass Trimmer

7589940/7495065/7497173

(Model: MET3525/MET4530/MET6032)

**Important - Please read these
instructions fully before starting assembly**

These instructions contain important information that will help you get the best from your grass trimmer, ensuring it is assembled correctly and safely. If you need help or have damaged or missing parts, call the Customer Helpline on 0345 605 2065

**AFTER SALES SUPPORT
0345 605 2065**

Contents

Safety information.....	3
In the box.....	7
Assemble.....	8
Prepare.....	9
Operate.....	12
Maintenance.....	16
Technical data.....	17
Accessories.....	18
Environmental protection.....	18
Getting help.....	19
Guarantee.....	19

Safety information

Important - Please read these instructions fully before starting assembly

Warning symbols



The following warning symbols appear throughout this assembly manual and indicate the appropriate safety measures you should take when assembling and operating the grass trimmer.



This symbol indicates there is a danger of serious personal injury or death if you do not observe the warning.

Read operator's manual



Do not expose to rain

General safety



WARNING!

Keep this assembly manual in a safe place following assembly for reference at a later date.

Always ensure anyone intending to operate this grass trimmer is fully conversant with the contents of this assembly manual prior to assembling, maintaining or operating the grass trimmer.

Perform assembly operations as described in this manual. Failure to observe this warning may lead to serious injury, death, or damage to the grass trimmer.

Always take care when removing the packaging to prevent damage to you or to the grass trimmer.



IMPORTANT! Before assembling the grass trimmer, check all the parts indicated in the manual are in the box. Inspect all the parts for signs of damage. Do not assemble the grass trimmer if you observe any damaged components.

Safety information

Important - Please read these instructions fully before starting assembly

Personal safety



WARNING!

Only operate the grass trimmer if you are wearing the correct Personal Protective Equipment (PPE) as described in the following warnings.

Warning symbols

The following warning symbols appear throughout this assembly manual and indicate the appropriate safety measures you should take when assembling and operating the grass trimmer.



Read operator's manual



Double insulation



Warning



Wear eye and ear protection



Keep bystanders away



Disconnect the mains plug if the cord becomes damaged or entangled



Do not expose to rain



Waste electrical products must not be disposed of with household waste. Please recycle where facilities exist. Check with your local authorities or retailer for recycling advice.

Safety information

Important - Please read these instructions fully before starting assembly

General safety



WARNING!

Read all safety warnings and all instructions. Failure to follow the warnings and instructions may result in electric shock, fire and/or serious injury.

Save all warnings and instructions for future reference.

If the supply cord is damaged, it must be replaced by the manufacturer, its service agent or similarly qualified persons in order to avoid a hazard.

IMPORTANT

READ CAREFULLY BEFORE USE

KEEP FOR FUTURE REFERENCE

Safe operating practices

1. Training

- a) Read the instructions carefully. Be familiar with the controls and the correct use of the machine.
- b) Never allow children, persons with reduced physical, sensory or mental capabilities or lack of experience and knowledge or people unfamiliar with these instructions to use the machine, local regulations may restrict the age of the operator.
- c) Keep in mind that the operator or user is responsible for accidents or hazards occurring to other people or their property.

2. Preparation

- a) Before use check the supply and extension cord for signs of damage or aging. If the cord becomes damaged during use, disconnect the cord from the supply immediately. **DO NOT TOUCH THE CORD BEFORE DISCONNECTING THE SUPPLY.** Do not use the machine if the

Safety information

Important - Please read these instructions fully before starting assembly

General safety

cord is damaged or worn.

b) keep extension cords away from moving hazardous parts to avoid damages to the cords which can lead to contact with live parts.

c) Before use, always visually inspect the machine for damaged, missing or misplaced guards or shields.

d) Never operate the machine while people, especially children, or pets are nearby.

3. Operation

a) Keep supply and extension cords away from cutting means.

b) Wear eye protection, long trousers and stout shoes at all times while operating the machine.

c) Avoid using the machine in bad weather conditions especially when there is a risk of lightning.

d) Use the machine only in daylight or good artificial light.

e) Never operate the machine with damaged guards or shields or without guards or shields in place.

f) Switch on the motor only when the hands and feet are away from the cutting means.

g) Always disconnect the machine from the power supply (e.g. remove the plug from the mains)

1) whenever the machine is left unattended;

2) before clearing a blockage;

3) before checking, cleaning or working on the machine;

In the box

Parts

- | | |
|------------------------------------|--------------------------------------|
| 1 On/Off switch | 11 Handle rotation locking button |
| 2 Front handle | 12 Cable holder |
| 3 Front handle locking knob | 13 Main handle |
| 4 Height adjustment locking collar | 14 Spool head cover |
| 5 Aluminum tube | 15 Line feed button |
| 6 Motor housing | 16 Cap release latch (on both sides) |
| 7 Flower guard | 17 Cutting line |
| 8 Spool head | 18 Line cutter |
| 9 Safety guard | 19 Cable |
| 10 Lower cable holder | 20 Instruction manual |

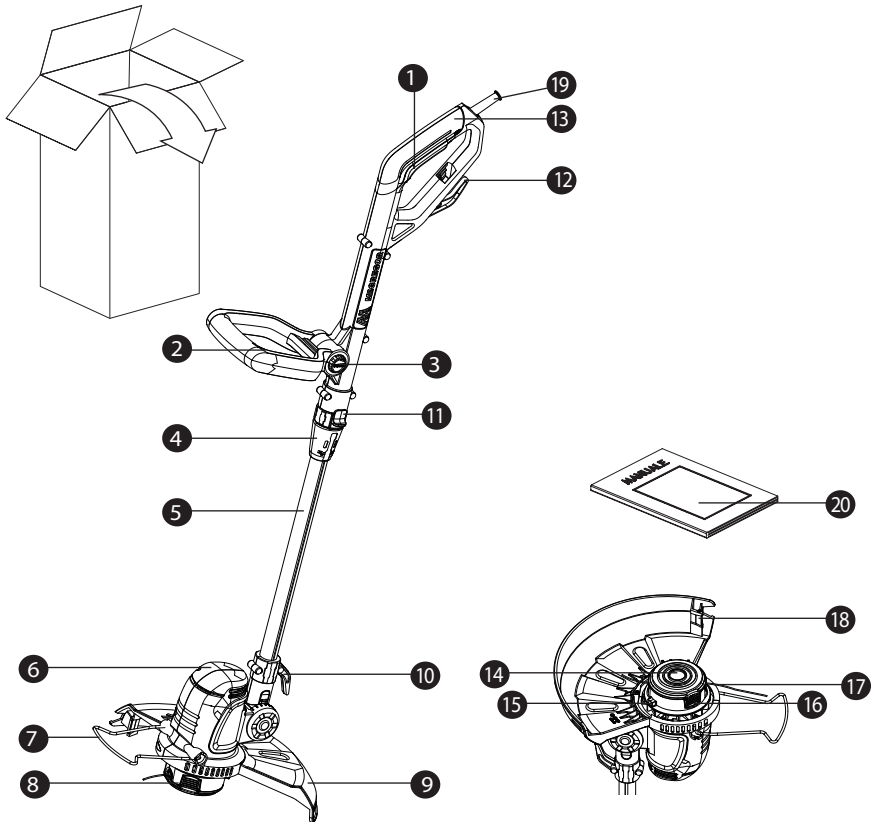

Assemble

Assembling instructions



Always take care when removing the packaging to prevent damage to you or to the grass trimmer.



IMPORTANT! Before assembling the grass trimmer, check all the parts indicated in the manual are in the box. Inspect all the parts for signs of damage. Do not assemble the grass trimmer if you observe any damaged components.



NOTE: Before using the tool, read the instruction book carefully.

INTENDED USE

The machine is intended for cutting weed, grass or similar soft vegetation in areas that are hard to reach, e.g. under bushes, on slopes and edges. It may not be used to work on unusual thick, dry or wet grass, e.g. pasture grass, or to shred leaves.

This machine is intended for private domestic use only, not for any commercial trade use. It must not be used for any purposes other than those described.

! WARNING! The guard must always be on the tool to protect the user.

1. FITTING THE GUARD (SEE FIG. A1, A2, A3)

- 1) Remove the mounting screw from safety guard, see FIG A1.
- 2) Attach the safety guard to the trimmer head, align the guard so it slides into the slots located on the trimmer head, see FIG A2.
- 3) Secure the safety guard onto the trimmer head with the screw provided, see A3.

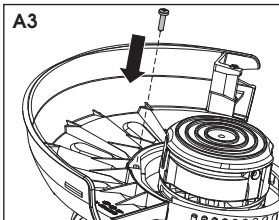
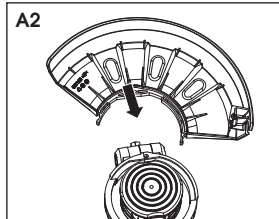
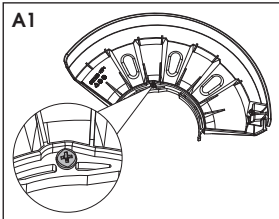

! WARNING! Take great care when doing this as the guard has a very sharp cutting edge. Never operate the tool without the guard properly in place. Use of the unit without having installed the guard will cause the motor to overheat, and void the warranty.

Assemble

Assembling instructions

2. REMOVING THE BLADE PROTECT LABEL (See Fig. B)

The blade is covered with a protect label. Please remove it before operation.

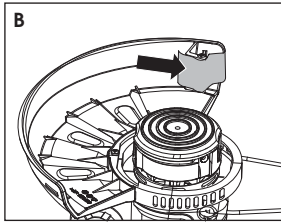

Prepare

Preparing instructions

2. ADJUST THE HEIGHT (See Fig. C1, C2)

- 1) Unscrew the height adjustment locking collar in the direction indicated to unlock, turn it clockwise.
- 2) Adjust the length of the Aluminum tube to the most comfortable length.
- 3) Tighten the locking collar in the direction indicated to lock, turn it counterclockwise.

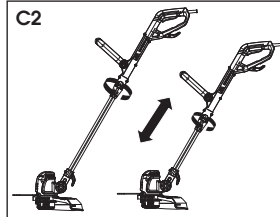
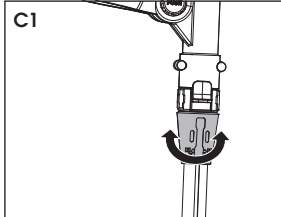

1. FRONT AUXILIARY HANDLE (See Fig. D)

- 1) Press the Front handle locking knob.
- 2) Rotate the Front handle to the most comfortable and balanced position.
- 3) Release the Front handle locking knob.

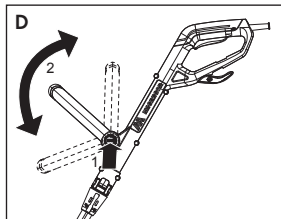

Prepare

Preparing instructions

3. ADJUSTING THE CUTTING ANGLE

⚠ WARNING: Always disconnect the trimmer before making adjustments!

- 1) Put one foot on the motor housing portion of the trimmer head, then grip the main handle and apply adequate force on the main handle pushing it downwards, as shown in Fig. E1.
- 2) Adjust the main handle angle upwards, put one foot on the safety guard area of the trimmer head, then grip the main handle, apply adequate force to adjust, as shown in Fig. E2.

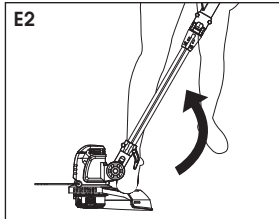
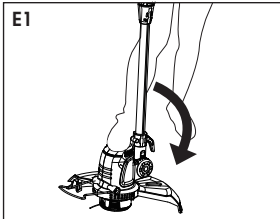

4. MAINS SUPPLY CABLE STRAIN RELIEF (See Fig. F)

Double the main supply cable, about a foot from the end. Lead the loop through the hole on the rear handle and hook the loop over the upper cable holder. Gently pull on the cord to ensure that it is firmly attached at the handle.

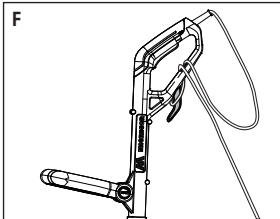

5. FLOWER GUARD (See Fig. G)

Lift the flower guard up when edging and put it down before trimming, as shown in Figure G. Before trimming or edging make sure the flower guard is locked firmly in position.

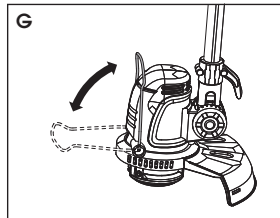

Prepare

Preparing instructions

6. ON/OFF SWITCH

To start, press and hold the switch. (See Fig. H)

Release the switch to stop.

⚠ WARNING: The cutting head continues to rotate after the trimmer has been switched off, wait until it has stopped then lay down the tool.

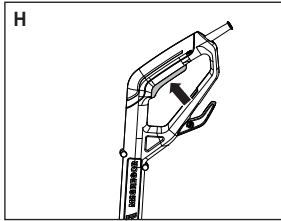

7. CABLE STORAGE (SEE FIG. I1, I2)

To release the cable, just turn down the upper cable holder (Fig. I2).

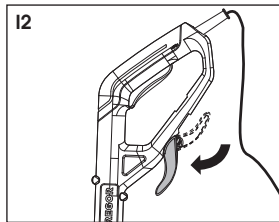
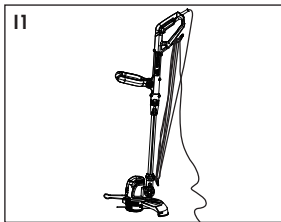

Operate

Operating instructions



WARNING: Always wear eye protection. Never lean over the trimmer head. Rocks or debris can ricochet or be thrown into eyes and face and cause blindness or other serious injury. When operating unit, check for the following:

Wear eye protection and heavy clothing. Hold front handle with one hand and auxiliary handle with the other hand. Keep unit below waist level. Work only from your right to your left to ensure debris is thrown away from you. Without bending over, keep line near and parallel to the ground (perpendicular when edging). Do not switch the machine on with the cutting head on or near material to be cut. Ensure the cutting line is at full speed before contacting material to be cut.



WARNING: MAKE SURE THAT LINE IS FED OUT BEFORE OPERATION. MAKE SURE MOTOR IS UP TO FULL SPEED BEFORE TRIMMING.



WARNING: Use only 1.65mm diameter cutting line. Other sizes of line will not feed properly and will result in improper cutting head function or can cause serious injury. Do not use other material such as wire, string, rope, etc. Wire can break off during cutting and become a dangerous missile that can cause serious injury.

1. TRIMMING

- 1) Keep the trimmer head at an angle of about 30° to the ground when trimming (Fig J1).
 - 2) Do not cut wet grass because it tends to stick to the trimmer head and guard, prevents proper discharge of grass clippings, and could cause you to slip and fall.
 - 3) Regularly remove clippings and dirt around the trimmer head with a switched off trimmer.
 - 4) Work rhythmically, stand firmly with your feet apart. Cut from right to left so the trimmings will be thrown away from the work area (Fig. J2).
 - 5) When cutting longer /high grass, please make sure that you cut this down in 2 to 3 stages (Fig. J3, J4).
 - 6) Do not move the trimmer too fast as this will result in ineffective cutting and possible damage.
- If you find that the nylon line is too short follow the instruction as in "Automatic line feed system" or "To manually feed the line".

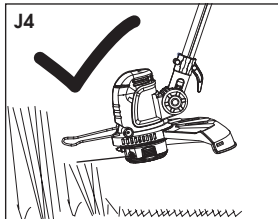
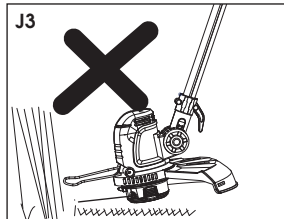
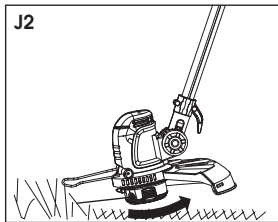
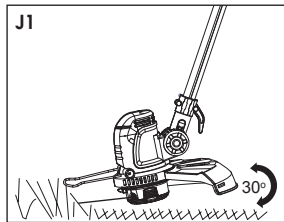

Operate

Operating instructions

2. EDGING

Change the tool from trimming to edging mode 01:

- 1) Adjust the cutting angle to be in the lowest horizontal setting as shown in Fig. K1.
- 2) Push the handle rotation locking button downward and rotate the main handle clockwise at 90 degree(Fig. K2, K3).

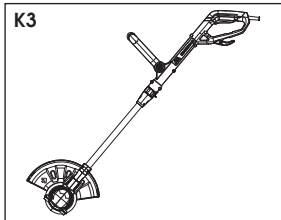
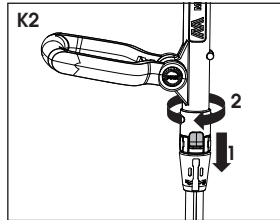
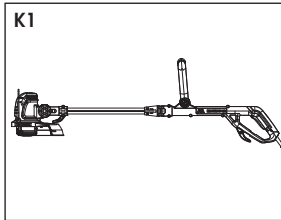

Change the tool from trimming to edging mode 02:

- 1) Adjust the cutting angle to 30 degree to 50 degree as shown in Fig. K4.
- 2) Push the handle rotation locking button downward and rotate the main handle clockwise at 180 degree(Fig. K5, K6).

While edging, only allow the tip of the line to make contact with area being worked. Do not force the line. Take extra caution while edging as objects can be thrown from the trimmer line.

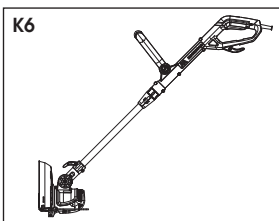
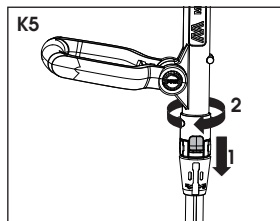
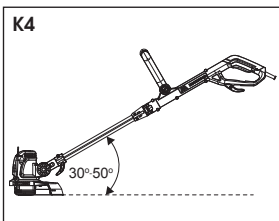

Operate

Operating instructions

3. AUTOMATIC LINE FEED SYSTEM

When initially switching on the trimmer, a small length of line is fed out.

A 'clattering' noise will be heard when the lines hit the line cutter. **DO NOT BE ALARMED**, this is quite normal. After about 5 seconds the line will be cut to the correct length and the noise will reduce as the motor receives full speed.

If the noise of the line being cut can't be heard, more line will be fed out.

To feed more line, it is first necessary to allow the trimmer to stop completely, then restart, allowing the motor to reach full speed.

Repeat above steps until you hear the lines hitting against the line cutter. (Do not repeat this procedure more than 6 times)

4. TO MANUALLY FEED THE LINE (SEE FIG. L)

If required, line can be fed out manually.

To operate, press and release manual line feed button, whilst gently pull out the lines until the lines reach the line cutter.

When the required amount of line is fed out, gently pull on the second line (there is no need to press the manual line feed button again)

If the line extends past the line cutter, too much line has been fed out.

If too much line is fed out, remove the spool cap and click spool anti-clockwise until the line is at the desired length.

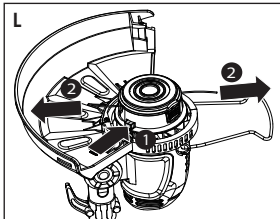

5. TO REMOVE THE CAP

Press and hold in the two cap release latches. (See Fig. M)

Pull cap away from the spool holder.

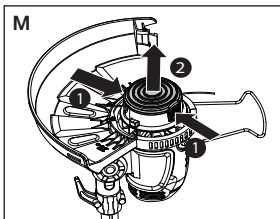

Operate

Operating instructions

6. WHEN REFITTING THE SPOOL CAP.

Keep all areas of the cap and spool holder clean.

Refit the cap, pressing firmly down towards the spool holder to ensure cap is fully located.

Check that the cap is correctly fitted by trying to remove it without depressing the two latches.

7. TO REPLACE CUT LINE.

For your convenience it is recommended you buy spool and line complete.

--TO FIT SPOOL AND LINE COMPLETE:

- 1) Remove old spool.
- 2) Place new spool into cutting head. Release one line from cleat and feed line through eyelet.
- 3) Repeat for second line.
- 4) Refit the cap.

--TO FIT NYLON LINE ONLY:

⚠ WARNING! Your trimmer is designed to use only line with a maximum diameter of 1.65 mm.

IMPORTANT - ALWAYS WIND THE LINE ONTO THE UPPER SECTION OF THE SPOOL FIRST.

- 1) Take two lines of approximately 3m (350W) / 5m (450W/600W) (Fig. N1).
- 2) Insert 15mm of line into one of the holes in the upper section of the spool and wind line in the direction of the arrows on the top of the spool (Fig. N2).
- 3) Leave approximately 100mm of line unwound and place into cleat (Fig. N3).
- 4) Repeat on lower section of spool with another line (Fig. N4).
- 5) Then fit spool as described in "TO FIT SPOOL AND LINE COMPLETE".

Care should be taken to ensure that the line is neatly coiled on the spool. Failure to do so will impair the efficiency of the automatic line feed.

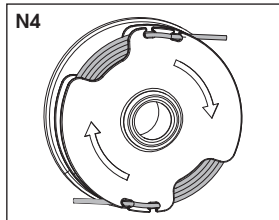
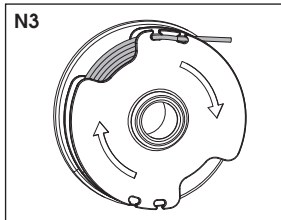
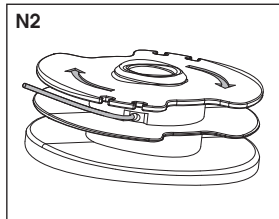
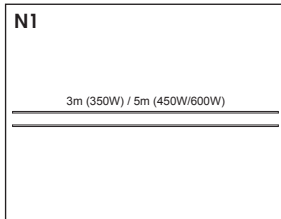

Maintenance

Maintenance

Remove the plug from the socket before carrying out any adjustment, servicing or maintenance.

Your power tool requires no additional lubrication or maintenance. There are no user serviceable parts in your power tool. Never use water or chemical cleaners to clean your power tool. Wipe clean with a dry cloth. Always store your power tool in a dry place. Keep the motor ventilation slots clean. Keep all working controls free of dust. Occasionally you may see sparks through the ventilation slots. This is normal and will not damage your power tool.

If the supply cord is damaged, it must be replaced by the manufacturer, its service agent or similarly qualified persons in order to avoid a hazard.

Storage

- a) Disconnect the machine from the power supply (e.g. remove the plug from the mains) before carrying out maintenance or cleaning work.
- b) Use only the manufacturer's recommended replacement parts and accessories.
- c) Inspect and maintain the machine regularly. Have the machine repaired only by an authorized repairer.
- d) When not in use, store the machine out of the reach of children.

Technical data

Technical data table

Model	MET3525	MET4530	MET6032
Voltage	230-240V~50/60Hz		
Power input	350W	450W	600W
No load speed	10500/min	9500/min	
Cutting width	25cm	30cm	32cm
Diameter of line	1.65mm		
Line length	2*3m	2*5m	
Protection class	□/II		
Machine weight	2.0kg	2.6kg	2.8kg

Noise and technical date

MET3525:

A weighted sound pressure

$$L_{pA} = 78\text{dB(A)}$$

A weighted sound power

$$K_{pA} = 3\text{ dB (A)}$$

$$L_{wA} = 93.6\text{dB(A)}$$

MET4530:

A weighted sound pressure

$$L_{pA} = 78\text{dB(A)}$$

A weighted sound power

$$K_{pA} = 3\text{ dB (A)}$$

$$L_{wA} = 93.7\text{dB(A)}$$

MET6032:

A weighted sound pressure

$$L_{pA} = 80\text{dB(A)}$$

A weighted sound power

$$K_{pA} = 3\text{ dB (A)}$$

$$L_{wA} = 95.8\text{dB(A)}$$

Wear ear protection.



VIBRATION INFORMATION

Typical weighted vibration $a_h = 2.5\text{m/s}^2$ uncertainty $K = 1.5\text{m/s}^2$



WARNING: The vibration emission value during actual use of the power tool can differ from the declared value depending on the ways in which the tool is used dependant on the following examples and other variations on how the tool is used:

How the tool is used and the materials being cut or drilled.

The tool being in good condition and well maintained

Using the correct accessory for the tool and ensuring it is sharp and in good condition.

The tightness of the grip on the handles and if any anti vibration accessories are used.

And the tool is being used as intended by its design and these instructions.

This tool may cause hand-arm vibration syndrome if its use is not adequately managed



WARNING: To be accurate, an estimation of exposure level in the actual conditions of use should also take account of all parts of the operating cycle such as the times when the tool is switched off and when it is running idle but not actually doing the job. This may significantly reduce the exposure level over the total working period.

Helping to minimise your vibration exposure risk.

ALWAYS use sharp chisels, drills and blades

Maintain this tool in accordance with these instructions and keep well lubricated (where appropriate)

If the tool is to be used regularly then invest in anti vibration accessories.

Plan your work schedule to spread any high vibration tool use across a number of days.

Accessories

	MET3525	MET4530	MET6032
Safety guard		1	
Flower guard		1	

We recommend that you purchase your accessories from the same store that sold you the tool. Choose the type according to the work you intend to undertake. Refer to the accessory packaging for further details. Store personnel can assist you and offer advice.

Troubleshooting

General troubleshooting

The following chart lists problem symptoms, possible causes and corrective action, if your electric grass trimmer does not operate properly. If these do not identify and correct the problem, contact your service agent.

⚠ WARNING! Always switch the product off, disconnect it from power supply and let the product cool down before performing inspection, maintenance and cleaning work!

Problem	Possible cause	Solution
Grass trimmer does not operate	1.1 No power 1.2 Mains socket faulty 1.3 Extension cord damaged 1.4 Fuse faulty	1.1 Check power 1.2 Check other socket, replace 1.3 Check cord, replace 1.4 Replace fuse
Grass trimmer operates intermittently	2.1 Extension cord damaged 2.2 Internal wiring damaged	2.1 Check cord, replace 2.2 Contact Service Agent
Grass trimmer labours	3. Grass too high	3. Cut in stages
Grass trimmer is not cutting	4 Line too short/broken off	4 Feed the line manually/automatically
Line can't be fed	5.1 Spool empty 5.2 Line inside the spool entangled	5.1 Replace the spool 5.2 Inspect the spool, rewind if necessary
Line keeps breaking	6.1 Line inside the spool entangled 6.2 Trimmer used incorrectly	6.1 Inspect the spool, rewind if necessary 6.2 Only trim with the tip of the line, avoid stones, walls and other hard objects. Feed the line regularly to maintain full cutting width.

Environmental protection



This product has been marked with a symbol relating to removing electric and electronic waste. This means that this product shall not be discarded with household waste but that it shall be returned to a collection system which conforms to the European Directive 2002/96/CE. It will then be recycled or dismantled in order to reduce the impact on the environment. Electric and electronic equipment can be hazardous for the environment and for human health since they contain hazardous substances.

Getting help

Customer helpline 0345 605 2065

Guarantee

Dear Customer,

In the unlikely event that your device develops a fault, please contact our Customer service department on the telephone number shown below.

1. These guarantee terms cover additional guarantee rights and do not affect your statutory warranty rights. Claims must be accompanied by Proof of Purchase. This must be in the form of a Sales receipt or Bank statement and must show that the product has been purchased within 2 years prior to the claim, from the retailer that it was originally sold to.
2. Our guarantee covers problems caused by material or manufacturing defects, and will result in the repair of these defects or replacement of the device with a like for like or similar article. Please note that our devices have not been designed for use in commercial, trade or industrial applications. Consequently, the guarantee is invalidated if the equipment is used in commercial, trade or industrial applications or for other equivalent activities.
3. The following are also excluded from our guarantee :
 - A. Faults due to accidents, customer misuse or unauthorized repairs
 - B. Consumable Parts such as detergent bottle, patio cleaner, jet lance, fix brush and nozzle pin.
 - C. Failure due to lack of routine maintenance.
 - D. Failure as a result of not using the equipment in accordance with the manual and safety instructions
 - E. The adjustment of cables, drives belts or recoil starters.
4. The guarantee is valid for a period of 2 years starting from the purchase date of the device. Guarantee claims should be submitted before the end of the guarantee period within two weeks of the defect being noticed. No guarantee claims will be accepted after the end of the guarantee period. The original guarantee period remains applicable to the device even if repairs are carried out or parts are replaced. In such cases, the work performed or parts fitted will not result in an extension of the guarantee period, and no new guarantee will become active for the work performed or parts fitted. This also applies when an on-site Service is used.
5. Please keep your sales receipt in a safe place. If it is covered by our guarantee your device will either be repaired under the terms of guarantee or we will send you a replacement device. This device may be re-conditioned or like for like replacement .

