



GENERATION FUTURE

EN



Thank-you for choosing a **Hoover** washing machine. We are proud to always offer new, innovative and technologically advanced products, with a complete range of home appliances to ensure true assistance in your daily routine.

We suggest you register your product at **www.registerhoover.com** to gain faster access to supplementary services solely reserved to our most loyal customers.

Carefully read this manual for correct and safe appliance use and for helpful tips on efficient maintenance.



Only use the washing machine after carefully reading these instructions. We recommend you always keep this manual on hand and in good condition for any future owners.

Please check that the appliance is delivered with this instruction manual, warranty certificate, service centre address and energy efficiency label. Also check that plugs, drain hose support hook and liquid detergent or bleach tray (only on some models) are included. We recommend you keep all these components.

On receipt of your appliance please check it carefully for damage. Any damage found must be reported to the delivery driver immediately. Alternatively damage found must be reported to the retailer within 2 days of receipt.

Each product is identified by a unique 16-character code, also called the “serial number”, printed on the sticker. This can be found inside the door opening. This code is a unique code for your product that you will need to register the product warranty, or if you need to contact the customer service centre.

Environmental conditions



This appliance is marked according to the European directive 2012/19/EU on Waste Electrical and Electronic Equipment (WEEE).

WEEE contains both polluting substances (which can cause negative consequences for the environment) and basic components (which can be re-used). It is important to have WEEE subjected to specific treatments, in order to remove and dispose properly all pollutants, and recover and recycle all materials. Individuals can play an important role in ensuring that WEEE does not become an environmental issue; it is essential to follow some basic rules:

- WEEE should not be treated as household waste;
- WEEE should be handed over to the relevant collection points managed by the municipality or by registered companies. In many countries, for large WEEE, home collection could be present.

In many countries, when you buy a new appliance, the old one may be returned to the retailer who has to collect it free of charge on a one-to-one basis, as long as the equipment is of equivalent type and has the same functions as the supplied equipment.

Contents

1. GENERAL SAFETY RULES
2. INSTALLATION
3. PRACTICAL TIPS
4. MAINTENANCE AND CLEANING
5. QUICK USER GUIDE
6. CONTROLS AND PROGRAMS
7. TROUBLESHOOTING AND WARRANTY

1. GENERAL SAFETY RULES

- This appliances is intended to be used in household and similar applications such as:
 - Staff kitchen areas in shops, offices and other working environments;
 - Farm houses;
 - By clients in hotels, motels and other residential type environments;
 - Bed and breakfast type environments.
 A different use of this appliance from household environment or from typical housekeeping functions, as commercial use by expert or trained users, is excluded even in the above applications. If the appliance is used in a manner inconsistent with this it may reduce the life of the appliance and may void the manufacturer's warranty. Any damage to the appliance or other damage or loss arising through use that is not consistent with domestic or household use (even if located in a domestic or household environment) shall not be accepted by the manufacturer to the fullest extent permitted by law.
- This appliance can be used by children aged from 8 years and above and persons with reduced physical, sensory or mental capabilities or lack of experience and knowledge if they have been given supervision or instruction concerning use of the appliance

in a safe way and understand the hazards involved.

Children shall not play with the appliance. Cleaning and user maintenance shall not be made by children without supervision.

- Children should be supervised to ensure that they do not play with the appliance.
- Children of less than 3 years should be kept away unless continuously supervised.
- If the supply cord is damaged, it must be replaced by the manufacturer, its service agent or similarly qualified persons in order to avoid a hazard.
- Only use the hose-sets supplied with the appliance for the water supply connection (do not reuse old hose-sets).
- Water pressure must be between 0.05 MPa and 0.8 MPa.
- Make sure carpets or rugs do not obstruct the base or any of the ventilation openings.
- The OFF condition is reached by placing the reference mark on the programmes control/knob in the vertical position. Any other different position of such control sets the machine in ON condition (only for models with programmes knob).

- After installation, the appliance must be positioned so that the plug is accessible.
- The maximum load capacity of dry clothes depends on the model used (see control panel).
- To consult the product technical specification please refer to the manufacturer website.
- Do not expose the washing machine to rain, direct sunlight or other weather elements. Protect from possible freezing.
- When moving, do not lift the washing machine by the knobs or detergent drawer; during transport, never rest the door on the trolley. We recommend two people lift the washing machine.

Safety instructions

- Before cleaning or maintaining the washing machine, unplug the appliance and turn off the water tap.
- Make sure the electrical system is earthed. Otherwise, seek qualified professional assistance.
- Please do not use converters, multiple sockets or extension cords.
- In the event of fault and/or malfunction, turn off the washing machine, close the water tap and do not tamper with the appliance. Immediately contact the Customer Service Centre and only use original spare parts. Failure to observe these instruction may jeopardise appliance safety.



WARNING:
water may reach very high temperatures during the wash cycle.

- Make sure there is no water in the drum before opening the door.
 - Do not pull on the power cord or appliance to unplug the machine.
- By placing the  mark on this product, we are confirming compliance to all relevant European safety, health and environmental requirements which are applicable in legislation for this product.**

2. INSTALLATION

- Release the power chord and drain hose from the securing clip at the rear of the machine.
- Remove the **2** or **4** transportation screws (**A**) on the back and remove the **2** or **4** flat washers, rubber bungs and plastic spacer tubes (**B**) as illustrated in **figure 1**.
- If the washing machine is built-in, unscrew the **3** or **4** transportation screws (**A**) and remove the **3** or **4** flat washers, rubber bungs and plastic spacer tubes (**B**).
- During the removal of the screws occasionally spacer tubes fall inside the product, these can be removed by tilting the product forward and recovering them from the floor or inside the base of the machine.
- Cover the open transportation screw holes with the **2** or **4** plastic caps included in the instruction bag.



WARNING:
keep packaging materials
away from children.

- Place the corrugated plastic sheet, found on top of the appliance during the unpacking process, into the base of the appliance as shown in **figure 2** (according to the model, consider version **A**, **B** or **C**).

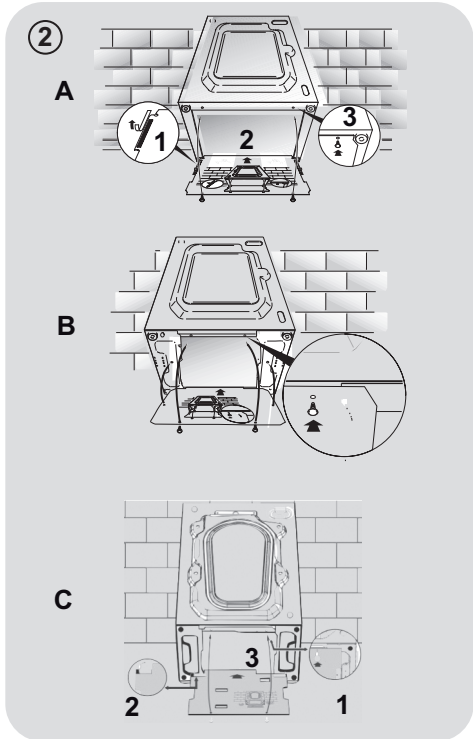
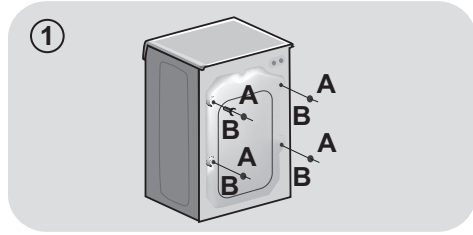

In some models this operation will not be necessary, because the corrugated plastic sheet will be already placed on the bottom of the appliance.

Hydraulic connections

- Connect the water hose to the water supply tap (**fig. 3**) only using the hose supplied with the appliance (do not reuse old hose-sets).
- Some models may include one or more of the following features:
 - **HOT&COLD (fig. 4):** water mains connection settings with hot and cold water for higher energy savings. Connect the grey tube to the cold water tap ❄️ and the red one to the hot water tap. The machine can be connected to the cold water tap only: in this case, some programs may start a few minutes later.
 - **AQUASTOP (fig. 5):** a device located on the supply tube that stops water flow if the tube deteriorates; in this case, a red mark will appear in the window "A" and the tube must be replaced. To unscrew the nut, press the one-way lock device "B".
 - **AQUAPROTECT – SUPPLY TUBE WITH GUARD (fig. 6):** Should water leak from the primary internal tube "A", the transparent containment sheath "B" will contain water to permit the washing cycle to complete. At the end of the cycle, contact the Customer Service Centre to replace the supply tube.

Setting

- The washing machine should be installed in its final position such that the water fill hose is not kinked or trapped. The corrugated drain hose should be inserted into suitable drain pipe of between 50 cm and 85 cm height above the floor using the curved drain hose support. If an under sink connection is used the drain hose must be routed above the sink overflow opening to prevent back siphoning. Care must be taken to avoid kinking or trapping the drain hose (**fig. 7**).

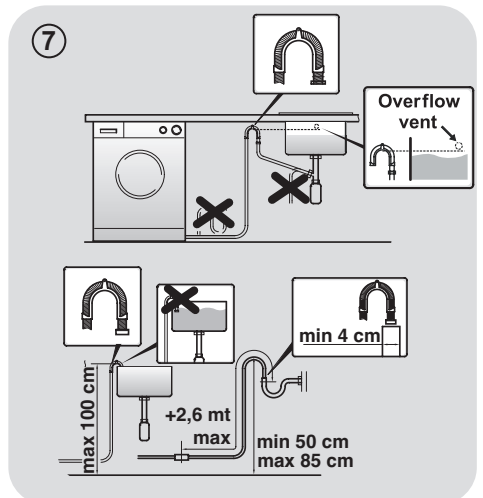
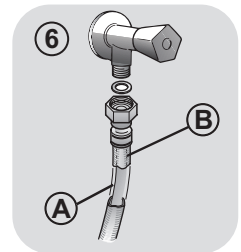
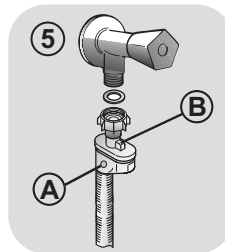
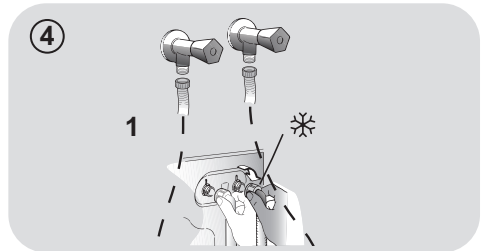
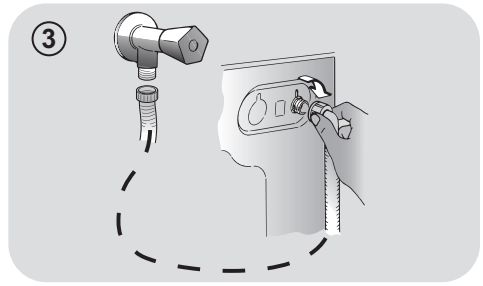

- Level the appliance using the feet as illustrated in **figure 8**:
 - a. turn the nut clockwise to release the screw;
 - b. rotate the foot to raise or lower it until it touches to the floor;
 - c. lock the foot, screwing in the nut, until it tightens against to the bottom of the washing machine.
- Plug in the appliance.

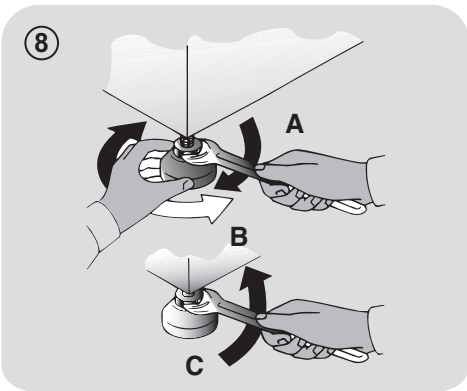

! WARNING:
 contact the Customer Service Centre should the power cord need replacement.

Detergent drawer

The detergent draw is split into 3 compartments as illustrated in **figure 9**:

- **compartment "1"**: for prewash detergent;
- **compartment "☼"**: for special additives, softeners, starch fragrances, etc.;

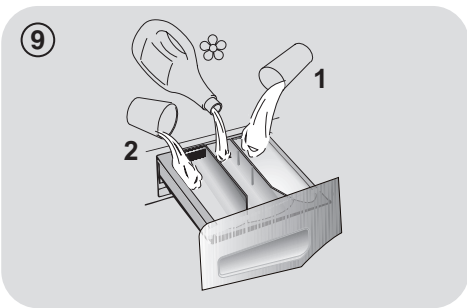

! WARNING:
 only use liquid products; the washing machine is set to automatically dose additives at each cycle during the last rinse.

- **compartment "2"**: for washing detergent.

A **liquid detergent cup** is also included **IN SOME MODELS** (fig. 10). To use it, place it in **compartment "2"**. This way, liquid detergent will only enter the drum at the right time. The cup can also be used for bleach when the "Rinse" program is selected.

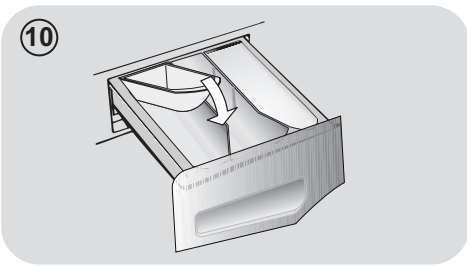

! WARNING:
 some detergents are not designed for use in the dispenser drawer but are supplied with their own dispenser that is placed in the drum directly.

! WARNING:
 installation faults are not covered by the manufacturers warranty.

3. PRACTICAL TIPS

Load tips

WARNING: when sorting laundry, make sure:

- have eliminated metallic objects such as hair clips, pins, coins, from laundry;
 - to have buttoned pillow cases, closed zips, tied loose belts and long robe ribbons;
 - to have removed rollers, hooks or clips from curtains;
 - to have carefully read clothing washing labels;
 - to have removed any persistent stains using specific detergents.
- When washing rugs, bedcovers or other heavy clothing, we recommend you avoid the spinning cycle.
 - To wash wool, make sure the item can be machine washed and marked by the "Pure virgin wool" symbol with the "Does not mat" or "Machine washable" label.

Helpful suggestions for the user

A guide environmentally friendly and economic use of your appliance.

Maximise The Load Size

- Achieve the best use of energy, water, detergent and time by using the recommended maximum load size. Save up to 50% energy by washing a full load instead of 2 half loads.

Do you need to pre-wash?

- For heavily soiled laundry only! SAVE detergent, time, water and between 5 to 15% energy consumption by NOT selecting Prewash for slight to normally soiled laundry.

Is a hot wash required?

- Pretreat stains with stain remover or soak dried in stains in water before washing to reduce the necessity of a hot wash programme. Save up to 50% energy by using a 60°C wash programme.

Following is a **quick guide** with tips and recommendations on **detergent use at the various temperatures**. In any case, always read the instructions on the detergent for correct use and doses.

When washing heavily soiled whites, we recommend using cotton programs of 60°C or above and a normal washing powder (heavy duty) that contains bleaching agents that at medium/high temperatures provide excellent results.

For washes between 40°C and 60°C the type of detergent used needs to be appropriate for the type of fabric and level of soiling.

Normal powders are suitable for "white" or colour fast fabrics with high soiling, while liquid detergents or "colour protecting" powders are suitable for coloured fabrics with light levels of soiling.

For washing at temperatures below 40°C we recommend the use of liquid detergents or detergents specifically labeled as suitable for low temperature washing.

For washing **wool** or **silk**, only use detergents specifically formulated for these fabrics.

4. MAINTENANCE AND CLEANING

To clean the washing machine exterior, use a damp cloth, avoiding abrasives, alcohol and/or solvents. To maintain a good wash performance we recommend that the soap drawer and pump filters are regularly cleaned. A monthly service wash, using a proprietary cleaner is also recommended.

Drawer cleaning

- We recommend you clean the drawer to avoid accumulating detergent and additive residue.
- To do this, extract the drawer using slight force, clean it with running water and reinsert it in its housing.
- Ensure the siphon cap is correctly refitted.

Filter cleaning

- The washing machine comes with a special filter able to trap large residue, such as buttons or coins, which could clog the drain.
- Only available on certain models: pull out the corrugated hose, remove the stopper and drain the water into a container.
- Ensure all the water has been emptied from the drum.
- Before unscrewing the filter, we recommend you place an absorbent cloth under it to keep the floor dry. A small amount of water will come out of the filter as you remove it - this is normal.
- Turn the filter counter-clockwise to the limit stop.

- Remove and clean the filter; when finished, replace it turning it clockwise. The filter handle will be locked when it is not possible to turn any further and the handle is horizontal. Smearing a small amount of liquid soap on the filter seal will help refitting.
- Repeat the previous steps in reverse order to reassemble all parts.

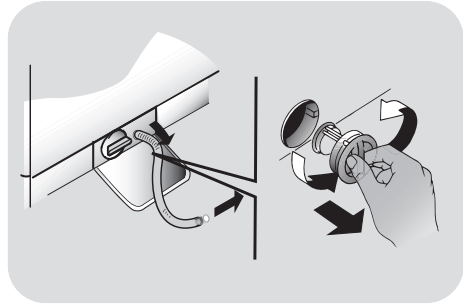

Suggestions for moves or prolonged disuse

- Should the washing machine be stored in an unheated room for a long period of time, drain all water from tubes.
- Unplug the washing machine.
- Detach the tube from the drainage system and clip on the rear of the machine and lower it, fully draining water into a bowl.
- Secure the drain tube with the drainage system and clip on the rear of the machine when finished.
- Keep the door glass and gasket clean.

The manufacturers warranty only covers faults within the product of a mechanical or electrical nature. Faults caused by handling, installation or miss use are not covered and may incur a charge for any repair visit to resolve.

5. QUICK USER GUIDE

This washing machine automatically adjusts the level of the water to the type and quantity of washing. This system gives a reduction in energy consumption and a saving in washing times.

Program selection

- Turn on the washing machine and select the required program.
- Adjust the washing temperature if necessary and press the required "option" buttons.
- Press the **START/PAUSE** button to start washing.

Should power go out when the washing machine is running, a special memory saves the settings and, when power returns, the machine resumes the cycle from where it left off.

- At the end of the programme, the message "End" will appear on the display or, on some models, all wash stage indicator lights will turn on.

Wait until the door locked light turns off: about 2 minutes after the program ends.

- Turn off the washing machine.

For any type of wash, see the program table and follow the operating sequence as indicated.

Technical data

Water pressure:

min 0.05 Mpa / max 0.8 Mpa
(0.05 MPa dispenses approximately 1 litre of water in 10 seconds)

Spin r.p.m.: See rating plate.

Power input / Power current fuse amp / Supply voltage: See rating plate.

6. CONTROLS AND PROGRAMS

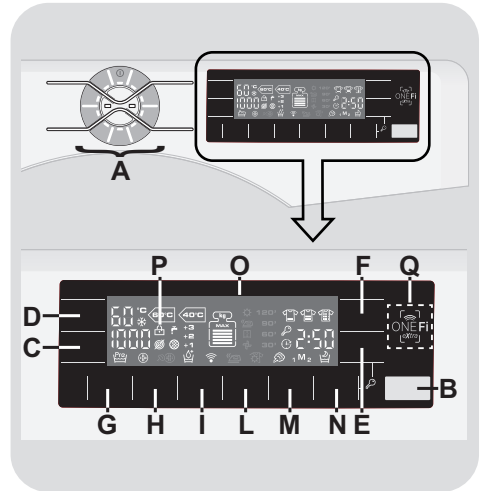

A Touch Control (with ON/OFF button)

B START/PAUSE button

C SPIN SPEED button

D TEMPERATURE SELECTION button

E DELAY START button

F RAPID / STAIN LEVEL button

G PREWASH button

H HYGIENE PLUS button

I EXTRA RINSE button

L ACTIVE STEAM button

M FAVOURITES button

N NIGHT & DAY button

O Digital display

P DOOR LOCKED indicator light

E+N KEY LOCK

Q ONE Fi EXTRA area



WARNING:

Don't touch the display (and the Touch Control) while inserting the plug because the machine calibrates the systems during the first seconds: touching the display, the machine couldn't work properly. In this case, remove the plug and repeat the operation.

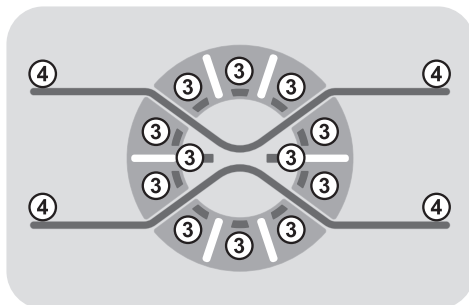

NE

Touch Control

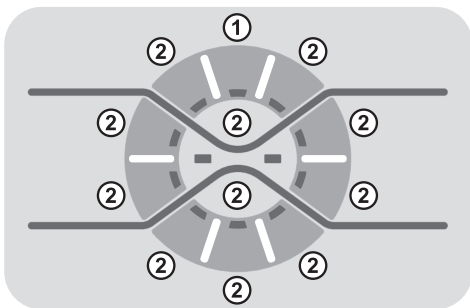

1) ON/OFF button

Press for at least **1 second** the **ON/OFF** button to turn on the appliance. Switching on, the related indicator will light on, as well as the **"X Red Light"**, waiting for the selection of a washing programme. If a programme is not selected within **30 seconds**, the appliance will automatically turn off. Waiting for the selection of the programme the display is off.

2) PROGRAMME SELECTION button

Turning on the appliance is also possible by pushing for at least **one second** the button of a selected programme (the display will light up, showing the parameters of the selected cycle). To set another programme, press the related button (the corresponding indicator light will light up). To switch off the appliance, press the **ON/OFF** button (for at least **3 seconds**).

3) BUTTON SELECTION indicators

They light up at the touch of the related button.

4) "X Red Light"

It lights up at the pressing of any button of the Touch Control, with a diffused lighting fading to the edges.

It gradually turns off within **5 minutes** since the last touch of a button, in order to save energy.

START/PAUSE button

Close the door BEFORE selecting the button START/PAUSE.

- Press to start the selected cycle.

When the START/PAUSE button has been pressed, the appliance can take few seconds before it starts working.

ADD OR REMOVE ITEMS AFTER THE PROGRAMMES HAS STARTED (PAUSE)

- Press and hold the **START/PAUSE** button for about **2 seconds** (some indicator light and the time remaining indicator will flash, showing that the machine has been paused).
- Wait until the **DOOR LOCKED** light has gone out before opening the door.

Before you open the door, please check water level is below the door opening to avoid flooding.

- After you have added or removed items, close the door and press the **START/PAUSE** button (the programme will start from where it left off).

CANCELLING THE PROGRAMME

- To cancel the programme, press the **ON/OFF** button (for at least **3 seconds**).
- Wait **2 minutes** until the safety device unlocks the door.

The option buttons should be selected before pressing the START/PAUSE button.

If an option is selected that is not compatible with the selected programme then the option indicator first flashes and then goes off.

SPIN SELECTION button

- By pressing this button, it is possible to reduce the maximum speed, and if you wish, the spin cycle can be cancelled.

 spin speed cancelled.

- If the label does not indicate specific information, it is possible to use the maximum spin expected in the programme.

To prevent damage to the fabrics, it is not possible to increase the speed over the maximum allowed for the programme.

- To reactivate the spin cycle press the button until you reach the spin speed you would like to set.

- It is possible to modify the spin speed without pausing the machine.

An over dosing of detergent can cause excessive foaming. If the appliance detects the presence of excessive foam, it may exclude the spinning phase or extend the duration of the program and increase water consumption.

The machine is fitted with a special electronic device, which prevents the spin cycle should the load be unbalanced. This reduces the noise and vibration in the machine and so prolongs the life of your machine.

TEMPERATURE SELECTION button

- This button allows you to change the temperature of the wash cycles.

 cold wash.

- It is not possible to raise the temperature over the maximum allowed for every programme, in order to save the fabrics.

DELAY START button

- This button allows you to pre-programme the wash cycle to delay the start of the cycle for up to **24 hours**.

- To delay the start use the following procedure:

- Set the required programme.

- Press the button once to activate it (**h00** appears on the display) and then press it again to set a **1 hour** delay (**h01** appears on the display). The pre-set delay increases by **1 hour** each time the button is pressed, until **h24** appears on the display, at which point pressing the button again will reset the delay start to zero.
- Confirm by pressing the **START/PAUSE** button (the light on the display starts to flash). The countdown will begin and when it has finished the programme will start automatically.
- It is possible to cancel the delay start by pressing the **ON/OFF** button (for at least **3 seconds**).

If there is any break in the power supply while the machine is operating, a special memory stores the selected programme and, when the power is restored, it continues where it left OFF

RAPID / STAIN LEVEL button

This button allows you to choose between two different options, depending on the selected programme.

- RAPID

The button becomes active when you select the **RAPID (14/30/44 Min.)** programme on the knob and allows you to select one of three durations indicated.

- STAIN LEVEL button

- Once the programme has been selected the wash time set for that programme will be automatically shown.
- This option allows you to choose between 3 levels of wash intensity modifying the length of the programme, depending on how much the fabrics are soiled (can only be used on some programmes as shown in the table of programmes).

PREWASH button

- This option allows you to make a prewash and it is particularly useful for heavily soiled loads (can be used only on some programmes as shown in the table of programmes).
- We recommend you use only 20% of the recommended quantities shown on the detergent pack.

HYGIENE PLUS button

With this option it is possible to hygienize the clothes, the washing programme reach a temperature of 60°C.

EXTRA RINSE button

- This button allows you to add rinses at the end of the washing cycle. The maximum number of extra rinses is related to the programme selected.
- This function has been studied for the people with delicate and sensitive skin, for which also a least residue of detergent can cause irritations or allergies.
- It advises to also use this function for the children items and in case of washings of very dirty items, for which it is due to use a lot of detergent, or in the washing of toweling items whose fibres mostly have the tendency to hold the detergent.

ACTIVE STEAM button

This button allows a specific treatment to follow certain wash cycles (please refer to the program table). The steam function works by relaxing creases in wet garments and as a result reduces the time needed to iron these items. The fibres are regenerated and refreshed by removing bad smells. Every program provides a dedicated steam treatment in order to ensure the maximum cleaning efficiency according to the items fabric type and colour.

FAVOURITES button

This function allows you to save the settings of your two favourite personalised programmes, including the temperature, spin speed and soil level, so you can recall them quickly.

How to memorize a programme for the first time:

- 1) Select the programme and the options you want.
- 2) Press the **FAVOURITES** button, choosing either **M1** or **M2**. You should choose **M1** if this is the first programme you have saved.
- 3) Keep your finger on the **FAVOURITES** button for about **3 seconds** to save the combination in the chosen position.

Memorize a new programme when M1 & M2 already have programmes saved:

- 1) Set the programme and the options you want.
- 2) Press the **FAVOURITES** button for about **3 seconds** to save the combination in the position **M1**. The pre-existing saved programme in **M1** will move in the position **M2**.

Start a program that is already memorized:

- Press briefly the **FAVOURITES** button (once for **M1**, twice for **M2**) and press the **START/PAUSE** button.
- Once you recall a memorized program, you can still change its options and settings, pressing the corresponding keys. In this case, the added options won't be memorized.

If you accidentally select a memorized program, simply turn the program knob to select another one.

NIGHT & DAY button

- This option reduces the intermediate spin speed to 400 rpm, where applicable, increase the water level during rinsing and keep the laundry immersed in water after the final rinse, in order to spread the fiber perfectly.
- During the phase in which the water is held in the tub, the relevant indicator light blink to show that the machine is at a standstill.
- Deselect the option to end the cycle with a spin dry (which may be reduced or cancelled using the appropriate button) and emptying phase.
- Thanks to electronic control, the water in the intermediate phases is emptied silently, making this option very useful for washing at night.

KEY LOCK

- Pressing simultaneously the buttons **NIGHT & DAY** and **DELAY START** for about **3 seconds**, the machine allows you to lock the keys. In this way, you can avoid making accidental or unwanted changes if a button on the display is pressed accidentally during a cycle.
- The key lock can be simply cancelled by pressing the two buttons simultaneously again or by pressing the **ON/OFF** button (for at least **3 seconds**).

Digital Display

The display's indicator system allows you to be constantly informed about the status of the machine.

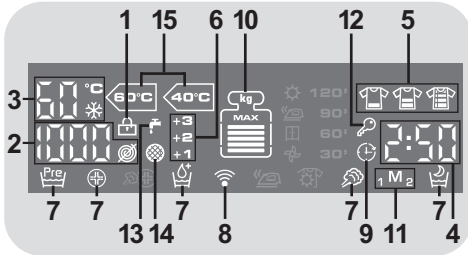

1) DOOR LOCKED INDICATOR LIGHT

- The indicator light is illuminated when the door is fully closed.

Close the door BEFORE selecting the START/PAUSE button.

- When **START/PAUSE** is pressed on the machine with the door closed, the indicator will flash momentarily and then illuminate.

If the door is not properly closed, the light will continue to flash for about 7 seconds, after which the start command will be automatically delete. In this case, close the door in the proper way and press the START/PAUSE button.

- Wait until the DOOR LOCKED light has gone out before opening the door.

2) SPIN SPEED

This show the spin speed of the selected programme that can be changed or omitted by the relevant button.

- ⊙ spin speed cancelled.

3) WASH TEMPERATURE

This show the washing temperature of the selected programme that can be changed (where allowed) by the relevant button.

- ❄ cold wash.

4) CYCLE DURATION

- When a programme is selected the display automatically shows the cycle duration, which can vary, depending on the options selected.

- Once the programme has started you will be kept informed constantly of the time remaining to the end of the wash.

- The appliance calculates the time to the end of the selected programme based upon a standard loading, during the cycle, the appliance corrects the time to that applicable to the size and composition of the load.

5) STAIN LEVEL INDICATOR LIGHTS

- Once the programme has been selected, the indicator light will automatically show the stain level set for that programme.
- Selecting a different stain level the relevant indicator will light up.

6) EXTRA RINSES INDICATOR LIGHTS

The indicator lights show the extra rinses selected by the relevant button.

7) OPTIONS INDICATOR LIGHTS

The indicator lights show the options that can be selected by the relevant buttons.

8) Wi-Fi (some models only)

- In the models with the Wi-Fi option, the icon indicates that the Wi-Fi system is working.

- For all the information about the functionality and the instructions for an easy configuration of the Wi-Fi, please refer to the **"Download"** section on <http://wizardservice.candy-hoover.com>.

9) DELAY START INDICATOR LIGHT

This flashes when delay start has been set.

10) Kg MODE *(function active only on certain programmes)*

- For the programmes where the "Kg MODE" function is active, the appliance in the first minutes it calculates the real laundry loaded, updating the levels on the display in real time.

Every levels shown on the display is the 20% of the maximum loading capacity.

When a programme is selected the maximum capacity suggested is shown on the display.

- Through every wash phase "Kg MODE" allows to monitor information on the wash load in the drum and in the first minutes of the wash it:

- adjusts the amount of water required;
- determines the length of the wash cycle;
- controls rinsing according to the type of fabric selected to be washed it;
- adjusts the rhythm of drum rotation for the type of fabric being washed;
- recognizes the presence of lather, increasing, if necessary, the amount of water during rinsing;
- adjusts the spin speed according to the load, thus avoiding any imbalance.

11) FAVOURITES

The indicator light show that the memory function is working.

12) KEY LOCK INDICATOR LIGHT

The indicator light show that the keys are locked.

13) TAP CLOSED INDICATOR LIGHT

Indicates that the machine is unable to load the water: it is suggested to turn off the machine, check that the tap is open and the water pressure is not particularly low.

14) FILTER BLOCKED INDICATOR LIGHT

Indicates that the machine is not able to drain the water: it is suggested to turn off the machine, check that the filter is not clogged or that the drain hose is not kinked or crushed.

15) STANDARD COTTON PROGRAMMES LIGHTS *(see table of programmes)*

The lights will light up when you select the most efficient program in terms of water and energy consumption, to wash cotton garments with a normal grade of soil.

ONE Fi EXTRA

This appliance is equipped with **ONE Fi EXTRA** technology that allows you to control it remotely via App, thanks to Wi-Fi function.

MACHINE ENROLLMENT (ON APP)

- Download the *Hoover Wizard* App on your device.

The *Hoover Wizard* App is available for devices running both Android and iOS, both for tablets and for smartphones.

Get all the details of the **ONE Fi EXTRA** functions by browsing the App in **DEMO** mode.

- Open the App, create the user profile and enroll the appliance following the instructions on the device display or the "Quick Guide" attached on the machine.

Using an Android smartphone equipped with NFC technology (Near Field Communication), the enrollment process is simplified (Easy Enrollment); in this case, follow the instructions on the phone display, **PLACE AND KEEP IT NEAR** the **ONE Fi EXTRA** logo on the machine dashboard, when requested to do so by the App.



NOTES:

Place your smartphone so that the NFC antenna on its back matches the position of the **ONE Fi EXTRA** logo on the appliance (as illustrated below).

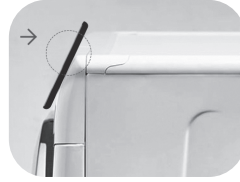

If you do not know the position of your NFC antenna, slightly move the smartphone in a circular motion over the **ONE Fi EXTRA** logo until the App confirms the connection. In order for the data transfer to be successful, it is essential **TO KEEP THE SMARTPHONE ON THE DASHBOARD DURING THESE THE FEW SECONDS OF THE PROCEDURE**; a message on the device will inform about the correct outcome of the operation and advise you when it is possible to move the smartphone away.





Thick cases or metallic stickers on your smartphone could affect or prevent the transmission of data between machine and telephone. If necessary, remove them.

The replacement of some components of the smartphone (e.g. back cover, battery, etc...) with non-original ones, could result in the NFC antenna removal.

ENABLE REMOTE CONTROL (VIA APP)

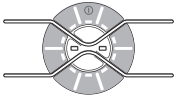
After the machine enrollment, every time you want to manage it remotely through the App, firstly you have to load the laundry, the detergent, close the door and select the **ONE Fi EXTRA** position on the machine. From that moment on you can manage it through the App commands.

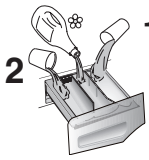
Table of programmes

 PROGRAMME	 (MAX.) * (see control panel)								 °C (MAX.)				
	6 kg	7 kg	8 kg	9 kg	10 kg	11 kg	12 kg	13 kg		2		1	
All In One 20°C 4)	4	4,5	5,5	6	6,5	7	8	8	20°	●	●		
All Hygiene 4)	4	4,5	5,5	6	6,5	7	8	8	60°	●	●		
All In One 49 Min.	6	7	8	9	10	11	12	13	40°	●	●		
Delicates 4)	2	2,5	2,5	2,5	2,5	2,5	3	3	40°	●	●		
Rinse	-	-	-	-	-	-	-	-	-	△	●		
Mixed & Coloured 2) 4)	3	3,5	4	4,5	5	5,5	6	6,5	40°	●	●	(●)	
Wool & Silk	1	1	2	2	2	2	2,5	2,5	30°	●	●		
 ** 2) 4)	6	7	8	9	10	11	12	13	90°	●	●	(●)	
Rapid ³⁾ 14-30-44 Min.	14'	1	1	1,5	1,5	1,5	1,5	2	2	30°	●	●	
	30'	2	2,5	2,5	2,5	2,5	2,5	3	3	30°	●	●	
	44'	3	3,5	3,5	3,5	3,5	3,5	4	4	40°	●	●	
Drain & Spin	-	-	-	-	-	-	-	-	-				

One Fi  Extra

Position that you have to select when you want to enable remote control through the App (via Wi-Fi). If the machine is not enrolled on the app yet, pressing the **START/PAUSE** button on the appliance will perform the "**Auto-Hygiene**" cycle, made to clean the drum.

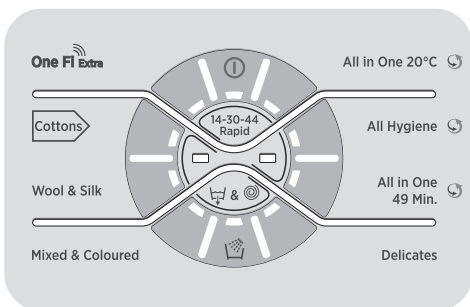

Please read these notes:

* Maximum load capacity of dry clothes, according to the model used (see control panel).

**** STANDARD COTTON PROGRAMMES ACCORDING TO (EU) No 1015/2010 and No 1061/2010.**

COTTON PROGRAMME WITH A TEMPERATURE OF 60°C.

COTTON PROGRAMME WITH A TEMPERATURE OF 40°C.

These programmes are suitable to clean normally soiled cotton laundry and they are the most efficient programmes in terms of combined energy and water consumptions for washing cotton laundry.

These programmes have been developed to be compliant with the temperature on the wash label on the garments and the actual water temperature may slightly differ from the declared temperature of the cycle.

- Only with PREWASH option selected (programmes with PREWASH option available).

△ (Only for models with liquid detergent compartment)

When only a limited number of articles have stains which require treatment with liquid bleaching agents, preliminary removal of stain can be carried out in the washing machine.

Pour the bleach into the liquid bleach container, inserted into the compartment marked "2" in the detergent drawer, and set the special programme RINSE.

When this phase has terminated, turn the programme selector to the OFF position, add the rest of the fabrics and proceed with a normal wash on the most suitable programme.

- 1) When a programme is selected, on the display is shown the recommended wash temperature that can be reduced (where allowed) by the relevant button.
- 2) For the programmes shown you can adjust the duration and intensity of the wash using the STAIN LEVEL button.
- 3) Selecting the RAPID program on the knob, it will be possible to select with the RAPID button, one of the three rapid programs available among 14', 30' and 44'.
- 4) Steam Function Available.



Programmes selection

To clean different types of fabrics and various levels of dirt, the washing machine has specific programs to meet every need of washing (see table of programmes).

ALL IN ONE technology

This washing machine is equipped with an innovative system with an high pressure jet that sprays a mixture of water and detergent directly into the load. The special motor movement used in this machine manages the drum movement during the start up of each programme, in conjunction with the high pressure jet spraying the detergent mixture into the load, the cycle includes a set of spin actions that helps the detergent solution to penetrate into the fibers, helping dirt removal and ensuring the best available wash performance. The **ALL IN ONE** system is also used during the water load phases where the high pressure jet aids the complete removal of detergent residues trapped in the clothes

All In One 20°C

Thanks to **ALL IN ONE** technology, this innovative programme, allows you to wash fabrics such as cottons, synthetics and mixed fabrics at 20°C with a performance which is comparable to a 40°C wash. The consumption of this program is about 50% of a conventional 40°C. Cottons wash.

IMPORTANT WASH PERFORMANCE ADVICE:

- New, coloured garments should be washed separately for at least 5 or 6 washes.
- Certain large dark items such as jeans and towels should always be washed separately.
- Never mix NON COLOURFAST fabrics.

All Hygiene

Thanks to the **ALL IN ONE** technology, this program ensures deep cleaning by optimizing the cycle in terms of temperature and rinses, eliminating allergens and detergent residues. Ideal for sensitive skin. Designed for cotton garments, it provides a 60°C temperature and is recommended for a reduced load.

All In One 49 Min.

This programme allows you to wash mixed fabrics such as cottons, synthetics and mixed fabrics in only 49 minutes, using the full load of the washing machine, at 40°C (or less) temperature. This programme is particularly suited to slightly dirty fabrics.

Delicates

This program has reduced periods of drum rotation during the cycle and is particularly suitable for washing delicate fabrics. The wash cycle and rinses are carried out with a high level of water to ensure the best performance.

Rinse

This program performs 3 rinses with an intermediate spin (which can be reduced or excluded by using the appropriate button) . It is used for rinsing any type of fabric, for example after a wash carried out by hand.

Mixed & Coloured

The washing and rinsing optimise the speed and rhythm of the drum action and water levels. The gentle spin, ensures a reduced formation of creases in the fabric.

Wool & Silk

This programme allows a delicate washing cycle, particularly suited to garments specified as "Machine-Washable" Wool fabrics and laundry items made from Silk or specified as "Wash as Silk" on the fabric label.

Cottons

This program is suitable to clean normally soiled cotton laundry and it is the most efficient program in terms of combined energy and water consumptions for washing cotton laundry.

Rapid (14-30-44 Min.)

Washing cycle suggested for low loads and slightly dirty. With this program it is recommended to reduce the quantity of detergent normally used, in order to avoid unnecessary waste. Selecting the RAPID program and acting on the button you can choose one of three programs available.

Drain & Spin

The program completes the drain and a maximum spin. It is possible to delete or reduce the spin with the SPIN SPEED button.

ONE Fi EXTRA

Position that you have to select when you want to enable remote control through the App (via Wi-Fi). In this case, the start of cycle will take place through the App commands. If the machine is not enrolled on the app yet,

pressing the **START/PAUSE** button on the appliance will perform the **"Auto-Hygiene"** cycle, made to clean the drum. Designed to sanitize the drum, remove bad smells and extend the life of the appliance, make sure there is no load in the drum before starting the **"Auto-Hygiene"** cycle and use a proprietary washing machine cleaning agent or powder detergent. Leave the door of the machine open at the end of the cycle to allow the drum to dry. Recommended every 50 washes.

7. TROUBLESHOOTING AND WARRANTY

If you believe the washing machine is not working correctly, consult the quick guide provided below which includes some practical tips on how to fix the most common problems.

ERROR CODE FORMAT

- **Models with a display:** the error is shown by a number preceded by the letter “E” (example: E2 = Error 2).
- **Models without display:** an error is shown by a sequence of flashes of every LED. The error code is shown by the number of flashes followed by a pause of 5 seconds (example: two flashes – pause 5 seconds – two flashes – repeating = Error 2).

Error shown	Possible causes and practical solutions
E2 (with display) 2 flashes of the LEDs (without display)	The machine cannot load water.
	Make sure the water supply tap is open.
	Make sure the water supply hose isn't bent, kinked or trapped.
	Make sure the drain pipe is at the proper height (see installation section).
E3 (with display) 3 flashes of the LEDs (without display)	Close the water supply tap, unscrew the filler hose from the back of the washing machine and make sure the “anti-sand” filter is clean and not blocked.
	The washing machine does not drain water.
	Make sure the filter is not clogged.
E4 (with display) 4 flashes of the LEDs (without display)	Make sure the drain hose isn't bent, kinked or trapped.
	Make sure the home drainage system is not blocked and is allowing water to flow through without obstruction. Try to drain the water in the sink.
E7 (with display) 7 flashes of the LEDs (without display)	There is too much foam and/or water.
	Ensure the correct amount of detergent is being used and the detergent is designed for use in a washing machine.
Any other code	Door problem.
	Make sure the door is correctly closed.
	Make sure the clothes inside the drum are not preventing the door from closing fully.
Any other code	If the door is locked, turn off and unplug the washing machine from the electrical supply socket, wait 2-3 minutes and reopen the door.
	Turn off and unplug the washing machine, wait a minute. Turn on the machine and restart a program. If the error occurs again contact an Authorised Customer Service Centre directly.

OTHER ANOMALIES

Problem	Possible causes and practical solutions
<p><i>The washing machine does not work / start</i></p>	Make sure the product is plugged into a working supply socket.
	Make sure power is on.
	Make sure the wall socket is working, testing it with another appliance such as a lamp.
	The door may not be correctly closed: open and close it again.
	Check whether the required program was correctly selected and the start button pressed.
<p><i>Water leaked on the floor near the washing machine</i></p>	Make sure the washing machine is not in pause or time delay mode.
	<p>This may be due to a leak from the seal between the tap, supply hose and fill valve; in this case, replace it and tighten the hose connections correctly.</p> <p>Make sure the front filter is correctly closed.</p>
<p><i>The washing machine does not spin</i></p>	<p>The machine is fitted with a detection system that protects the load and product from damage if the load is not balanced before spinning. This may result in:-</p> <ul style="list-style-type: none"> • The machine attempts to balance the load, increasing the time of spin. • Reduction of the speed of spin to decrease vibrations and noise. • The spin cycle aborting to protect the machine and load. <p>If this is experienced remove the load de-tangle it, reload it and restart the spin program.</p>
	<p>This could be due to the fact that water has not been completely drained: wait a few minutes. If the problem persists, see Error 3 section.</p>
	<p>Some models include a "no spin" function: make sure it is not selected.</p>
	<p>Check which options are selected and their effect on the spin cycle.</p>
	<p>Excessive detergent can impede the spin cycle, ensure the correct amount of detergent is being used.</p>
<p><i>Strong vibrations / noises are heard during the spin cycle</i></p>	<p>The washing machine may not be fully levelled: if necessary, adjust the feet as indicated in the specific section.</p>
	<p>Make sure transport screws, rubber bungs and spacer tubes were removed.</p>
	<p>Make sure there are no foreign objects inside the drum (coins, hinges, buttons, etc...).</p>

The standard manufacturer warranty covers faults caused by electrical or mechanical faults in the product due to an act or omission of the manufacturer. If a fault is found to be caused by factors outside the product supplied, miss-use or as a result of the instructions on use not being followed, a charge may be applied.

The use of ecological detergents without phosphates may cause the following effects:

- **cloudier rinse drain water:** This effect is tied to the suspended zeolites which do not have negative effects on rinse efficiency.
- **white powder (zeolites) on laundry at the end of the wash:** this is normal, the powder is not absorbed by fabric and does not change its colour.
To remove the zeolites, select a rinse programme. In the future consider using slightly less detergent.
- **foam in the water at last rinse:** this does not necessary indicate poor rinsing. Consider using less detergent in future washes.
- **abundant foam:** This is often due to the anionic surfactants found in the detergents which are hard to eliminate from laundry. In this case, do not re-rinse to eliminate these effects: it will not help at all. We suggest conducting a maintenance wash using a proprietary cleaner.

If the problem persists or if you suspect a malfunction, immediately contact an Authorised Customer Service Centre.

It is always recommended to use original spare parts, that are available at our Authorised Customer Service Centres.

Warranty

The product is guaranteed under the terms and conditions stated on the certificate included with the product. The warranty certificate must be duly filled in and stored, so as to be shown to the Authorised Customer Service Centre in case of need. Proof of purchase must be made available at the time of any warranty related repair.

WIRELESS PARAMETERS

(for model with NFC function)

Parameter	Specifications
Wireless Standard	ISO/IEC 14443 Type A and NFC Forum Type 4
Frequency band	13,553-13,567 MHz (centre frequency 13,560 MHz)
Magnetic field limit	< 42dBµA/m (at 10 meters)

With this the Candy Hoover Group Srl, declares that this appliance marked with  complies with the essential requirements of the Directive 2014/53/EU. To receive a copy of the declaration of conformity, please contact the manufacturer at: www.candy-group.com

The manufacturer declines all responsibility for any printing errors in the booklet included with this product. Moreover, it also reserves the right to make any changes deemed useful to its products without changing their essential characteristics.

