

# Instruction Manual

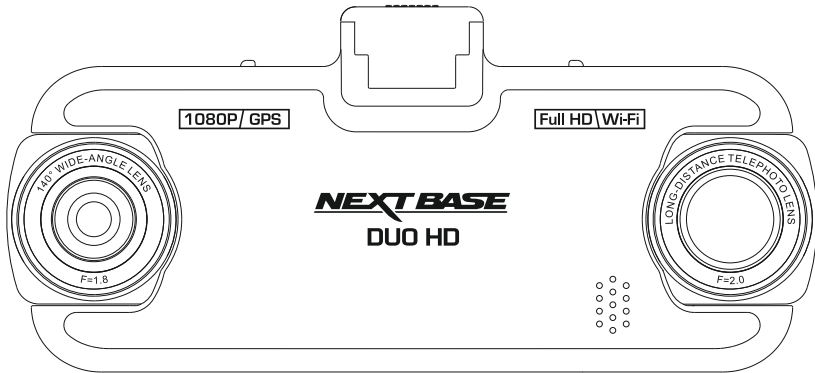



## INTRODUCTION TO USING A DASH CAM

The iN-CAR CAM range of Dash Cams have been designed specifically with ease of use in mind, it is recommended NOT to change the default settings, which have been carefully selected to give the best performance for day to day use.

Basic operation.

The Dash Cam is set to record video, in files of just 3 minutes in length. This means that each video file is a manageable size should you need to download and send to your insurance company. Eventually your MicroSD card will fill up with video files but don't worry, the camera automatically deletes the oldest file to make space for new recordings. This way you never run out of space and have plenty of driving historical evidence saved.

Typically a 16Gb card will store the last 2 hours of driving footage.

The Time and Date are automatically set upon the camera from satellite data, based on the Country selected from within the first Time Use menu.

The Time and Date will also update automatically for Daylight Savings Time, again based on the Country selected.

There are 3 modes of camera operation - Video, Photo and Playback.

Video Mode: The default mode when the camera is turned on, for video recording.

Photo Mode: Allows you to take still photographs from the Wide Angle lens camera.

Playback mode: Allows you to view recorded video or photographs upon the Dash Cam LCD screen. Press the MODE button on the Dash Cam to select required mode.

Automatic Start / Stop Technology. The Dash Cam senses power supplied to the cigarette lighter socket as soon as the vehicle ignition is turned on and will start to record automatically. When the ignition is turned off, the Dash Cam will perform an automatic shutdown process.

### 1. Tips for capturing best video footage:

- 1.1 Position the Dash Cam in the centre of the windscreen and ideally behind the rear view mirror, yet allowing the zoom lens clear view through the car and out of the rear windscreen.
- 1.2 Reduce the amount of sky in the picture, by angling the view of the camera towards the road. Too much sky will make the road appear darker due to the automatic exposure compensation.
- 1.3 Remove unnecessary items from your dashboard. If objects are placed on your dashboard these can cause reflections to be seen on the windscreen and these reflections may be captured during recording.

### 2. Tips for stable memory card performance:

- 2.1 Periodically reformat the memory card. Every 2-3 weeks we recommend that you reformat the memory card. This will wipe any files from the card and set it up afresh for continued use with your Dash Cam.  
Of course, you should only do this AFTER you've downloaded any files from the card that you may want to keep, as formatting the card will remove all content.
- 2.1 Format your memory card using the Dash Cam. This will make sure that the card is structured specifically for your camera. Press MENU twice and choose the Format Card option. Follow the on-screen instructions accordingly.
- 2.2 Switch off the Dash Cam before inserting or removing the SD memory card, to prevent the chance of damage being caused to the memory card or the files stored upon it.

## TABLE OF CONTENTS

INTRODUCTION TO USING A DASH CAM .....	03
TABLE OF CONTENTS .....	04
PRECAUTIONS .....	05
CAUTIONS ON USING THIS PRODUCT .....	05
PRODUCT SPECIFICATION .....	06
PACKAGE CONTENTS .....	07
PRODUCT FEATURES .....	07
POWERED GPS MOUNT .....	08
CAMERA - PARTS & CONTROLS .....	09
IN VEHICLE INSTALLATION .....	13
FIRST TIME USE .....	17
DAYLIGHT SAVING TIME .....	17
VIDEO MODE .....	18
PHOTO MODE .....	25
PLAYBACK MODE .....	27
SETUP MENU .....	32
PC CONNECTION .....	36
TV CONNECTION .....	37
TROUBLE SHOOTING .....	38

## PRECAUTIONS

Please read this manual carefully before operation and keep it for future reference. It will be helpful should you encounter any operational problem.

**WARNING:** Do not expose this product to rain, moisture or water under any circumstances, doing so may result in the risk of electric shock or fire.

**CAUTION:** To reduce the risk of electric shock, do not perform any servicing other than that contained in the instruction manual unless you are qualified to do so.

Have the unit serviced by a qualified service technician if;

The Unit has been exposed to rain or water.

The unit does not seem to operate normally.

The unit exhibits a marked change in performance.

**LCD:** A Liquid Crystal Display (LCD) screen is a multilayer complex component, containing 691,200 pixels. Pixels can however fail during normal product life. 1 pixel = 0.0001% failure rate, and one pixel failure per year of operation is considered normal and not a cause for concern.

**WEEE:** Disposal of Waste Electrical and Electronic Equipment and/or Battery by users in private households in the European Union.



This symbol on the product or on the packaging indicates that this cannot be disposed of as household waste. You must dispose of your waste equipment and/or battery by handing it over to the applicable take-back scheme for the recycling of electronic equipment and/or batteries. For more information please contact your local household waste disposal office.

## CAUTIONS ON USING THIS PRODUCT

1. Ensure that the windscreen is free of dirt or grease before placing mount upon it.
2. Do not obscure the view of the road ahead or impede the deployment of any airbags in the event of an accident.
3. When not in use, please disconnect the car adaptor from both the 12/24Vdc outlet in your ] vehicle and the device itself.
4. Only clean the device with a soft dry cloth, for tough dirt, apply some neutral detergent diluted in 5 to 6 parts water to a soft cloth.

Note that alcohol, thinner, benzene etc could cause damage to the paint or coatings.

5. Avoid making contact with the lens as damage may be caused.
6. If required clean the glass lens carefully using spectacle lens cleaning fluid on a soft cloth only.
7. The video recordings made by this Digital Video Recorder are intended for personal use only.
8. Publication of the recordings on Youtube, the internet or other methods are subject to the Data Protection Act and the requirements thereof must be adhered to.

If the Digital Video Recorder is to be used within a commercial environment, i.e. truck use, then the CCTV regulation apply also, in addition to the Data Protection Act regulations. This includes labelling to identify the use of CCTV is taking place, the omission of Audio recording and informing the relevant authorities of who controls the data.

9. Video playback upon the device which is visible to the driver is prohibited or restricted in some countries or States. Please adhere to these laws.
10. Whilst driving, do not adjust the controls of your device as this is a distraction to driving.

## PRODUCT SPECIFICATION

Model Number	NBDVRDUOHD
Power Requirements	5V / 1.5A
Power Supply	12-24Vdc Car Power Cable (supplied) Fuse Type: 20mm / 2A Output: 5Vdc
Sensor Resolution	2.12 MP (2,123,792 Pixels)
Front Camera (wide angle) - Type / Angle / Aperture	6G / 140° / F2.0
Rear Camera (zoom)- Type / Angle / Aperture	6G / 25° / F1.6
Recording Resolution	1920 x 1080 @ 30fps
Screen Size	2.7"
Screen Resolution	960 (W) X 240 (H) pixels x RGB
Screen Ratio	16:9
Card Reader	MicroSD, Class 6-10, up to 128GB
SD Card (Recommended Type)	8-128GB MicroSD Card, Class 10 (48mb/s), for best results use a recognized brand
SD Card Recorded File Capacity (based on default settings)	8GB MicroSD = 60 minutes of recording 16GB MicroSD = 120 minutes of recording 32GB MicroSD = 240 minutes of recording 64GB MicroSD = 480 minutes of recording 128GB MicroSD = 960 minutes of recording
Recording Format	MOV
Video / Audio Out	High Definition: Type C Socket (Video / Audio)
Internal Battery	Lithium-ion 3.7V / 800mAh (approx. 20mins recording time) Battery design allows the 'Auto Power Off' feature to function in event of power loss within the vehicle. It is not intended as an alternative power source to replace the supplied car adaptor.
Unit Dimensions	140 x 65 x 38mm
Unit Weight	97g

Android is a trademark of Google Inc. in the United States and other countries.

Mac is a registered trademark of Apple Inc. in the United States and other countries.

iOS is a trademark or registered trademark of Cisco in the United States and other countries.

Windows is a registered trademark of Microsoft Corporation in the United States and other countries.

Exmor R is a trademark of Sony Corporation. STARVIS is a trademark of Sony Corporation.





NEXTBASE Replay 3 is a registered trademark of Portable Multimedia LTD in the United Kingdom.

NEXTBASE Cam Viewer is a registered trademark of Portable Multimedia LTD in the United Kingdom.

© 2015 Google Inc. All rights reserved. Google Maps™ mapping service is a trademark of Google Inc.

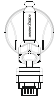
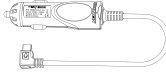
## PACKAGE CONTENTS

Please check the contents of your NEXTBASE product.

<p><b>Dash Cam</b></p> 	<p><b>Powered GPS Mount</b></p>  <p>(adhesive mount included)</p>	<p><b>Car Power Cable</b></p> 	<p><b>USB Cable</b></p> 
<p><b>Window Sticker</b></p> 	<p><b>Quick Start Guide</b></p> 	<p><b>Instruction Manual &amp; Software Disk</b></p> 	

Product appearance may differ slightly to that shown above.

## PRODUCT FEATURES

Thank you for purchasing this NEXTBASE Dash Cam, in this section we will outline some of the features available with this Dash Cam.

### Dual Cameras with 180° Lens Rotation

Dual lens design allows viewing in any direction, the wide-angle lens to the front and zoom lens to the rear.

### 2.7" LCD Colour Screen

LCD screen for ease of use and viewing the playback of recorded videos and photos.

### Powered GPS Mount

Supplied with an Easy-fit powered mount, which allows the Dash Cam to be fitted and removed quickly and easily. The car power cable can remain in place, connected to the mount.

### GPS Logger

GPS co-ordinates, date and time are recorded, the journey can then be viewed using the supplied Windows & Mac playback software.

The software is also available to download from [www.nextbase.co.uk](http://www.nextbase.co.uk)

### Wi-Fi Connectivity

Connect your smartphone or tablet device to the Dash Cam, can be used to Start/Stop recording or to view or download files from the Dash Cam.

### G Sensor / File Protection

In the event of an impact the device will automatically 'protect' the recording, stopping the file from being over-written. This can also be performed manually, by pressing the 'protect' button.

Individual files can also be 'protected' when viewed within playback mode.

### Parking Mode

The Dash Cam will power on automatically and make a protected recording, when physical movement of your vehicle is detected.

## POWERED GPS MOUNT

Please see below to identify the parts of the supplied powered mount.

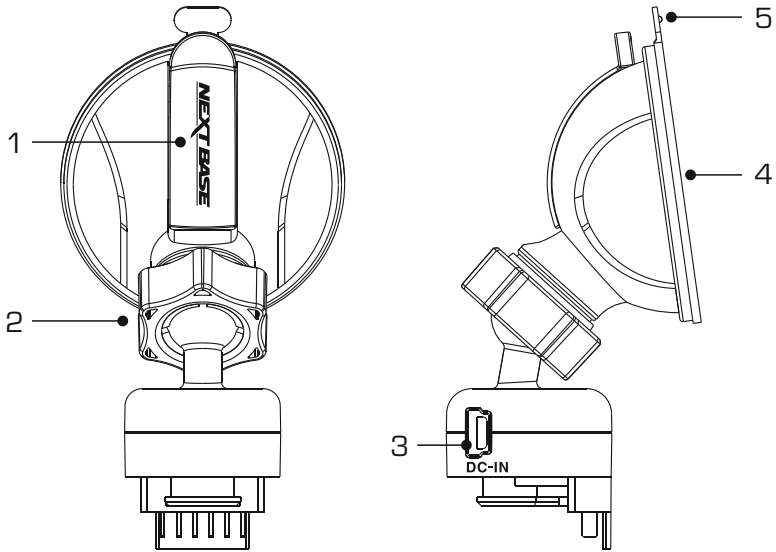

**1. Locking lever**

The locking lever is used to attach and release the window mount to your vehicles windscreen. Pull the lever down to prepare the window mount for use. Once the mount is firmly upon the windscreen (in a suitable location) push the lever to lock the mount in place.

**2. Locking ring**

Loosen the locking ring to adjust the Dash Cam position if required, remembering to re-tighten before use.

**3. DC-IN socket**

Connect the supplied car power cable here.

**4. Suction cup**

This is used to attach and release the window mount to your vehicles windscreen. Affix to a clear piece of windscreen where there is no paint effect applied.

**5. Suction release tab**

Once the locking lever has been opened use this release tab to break the seal between the mount and windscreen.



## CAMERA - PARTS & CONTROLS

Please see below to identify the parts and controls of your Dash Cam.

Front:

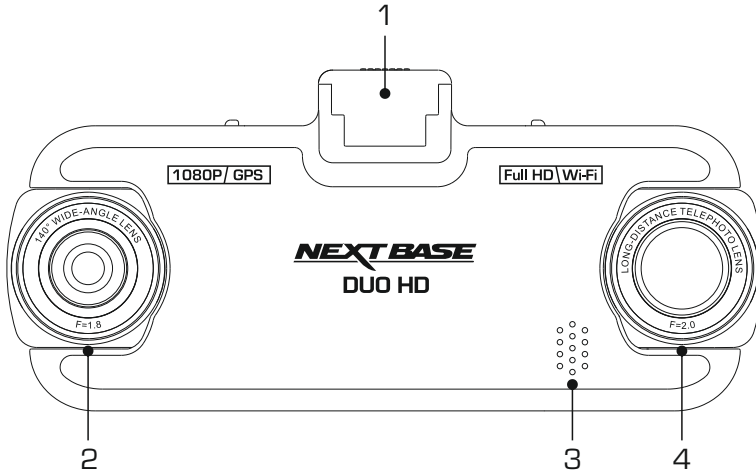

- 1. Mounting point (located under the dust cover)**  
After removing the dust cover, attach the supplied powered GPS mount here.
- 2. Wide Angle Lens**  
This is the front facing camera, for recording ahead of the vehicle.
- 3. Speaker**  
Integral speaker for audio playback directly from the Dash Cam.
- 4. Zoom Lens**  
This is the rear facing camera, typically used for recording behind the vehicle.

**CAMERA - PARTS & CONTROLS (CONTD.)**

Back:

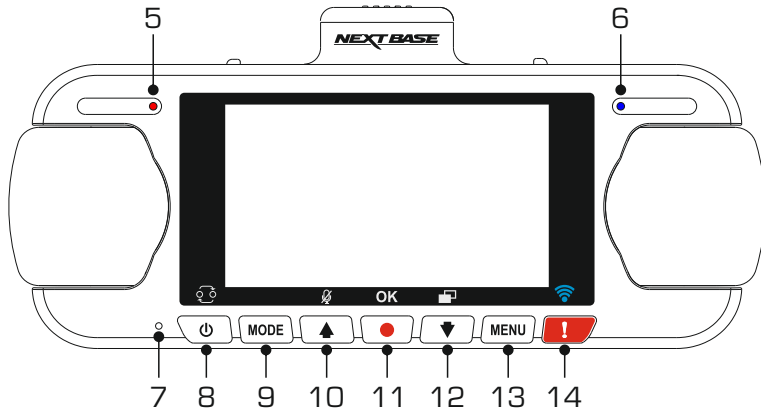
**5. Power & Recording LED Indicator (red)**

The red LED will be lit when the Dash Cam is turned on and will flash during recording.

**6. Battery LED Indicator (blue)**

The blue LED will be lit when the battery is charging, once fully charged the LED will go out.

**7. Microphone**

Integral microphone for audio recording.

**8. Power /Picture in Picture (PiP) Select button**

Power:

Press and hold for 2 seconds to turn the Dash Cam on and off.

PiP Select:

Select which camera is seen on the Dash Cam's screen. This is useful during initial setup of the product to make sure the two camera lenses are positioned correctly.

Note:

- Changing the PiP setting does not affect the Camera Select option and / or the recorded file.

**9. Mode button**

Press to change between video, photo or playback modes.

**CAMERA - PARTS & CONTROLS (CONTD.)**

Back continued:

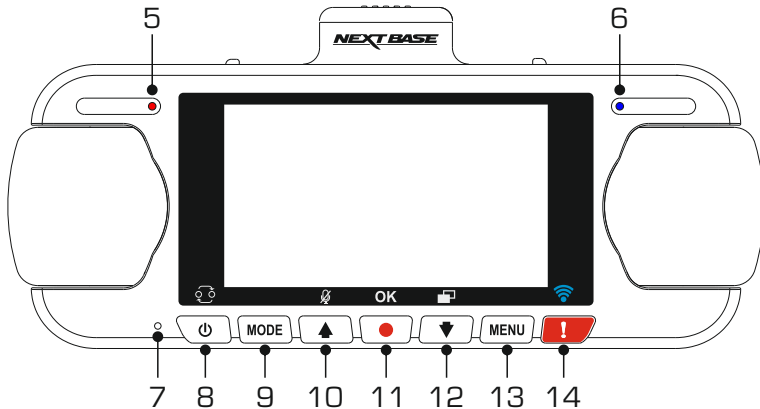
**10. Up / Microphone button**

Up:

Press to navigate up within menus and to move to the previous file when in playback mode.

Microphone:

Press to turn off / on the microphone (audio recording).

**11. Record button**

Press to start or stop a recording when in video mode, or take a photo when in photo mode.

**12. Down / Screen Saver button**

Down:

Press to navigate down within menus and to move to the next file when in playback mode

Screen Saver:

Press to turn Off / On the screen.

**13. Menu button**

Press to open the menu within current mode, press twice to open the Setup Menu.

**14. Protect button**

Press whilst recording to protect the current file in event of an emergency situation.

Once the Protect button has been pressed, Video files are protected so that the complete incident is recorded. This may result in multiple files being protected to ensure that the events leading up to or after the incident can not be deleted.

## CAMERA - PARTS & CONTROLS (CONTD.)

Bottom:

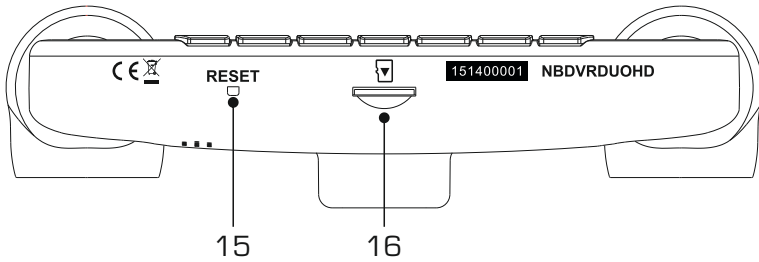

### 15. RESET button

In the unlikely event the Dash Cam becomes unresponsive, press the RESET button to restart the Dash Cam.

### 16. MicroSD Slot

Insert the MicroSD card here, taking care that the gold contacts are facing towards the back of the Dash Cam.

Top:

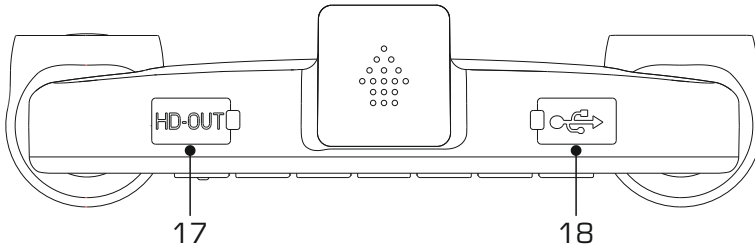

### 17. HD Out Socket

Connect your Dash Cam to a television using an HD Cable (sold separately).

### 18. DC-IN & USB socket (located under the dust cover)

Connect the supplied car power cable or USB data cable here.

Note:

- Normally the car power cable is connected to the mount when in use, not directly to this socket.

## IN VEHICLE INSTALLATION

Please follow the instructions below for first-time installation of the Dash Cam. For day to day use simply remove the camera from the mount as required.

### 1. Insert MicroSD Card

Insert a suitable MicroSD card (Class 10 48/Mbps) in to the Dash Cam, taking care that the gold contacts are facing towards the LCD screen side of the Dash Cam. Push the memory card until it clicks into place.

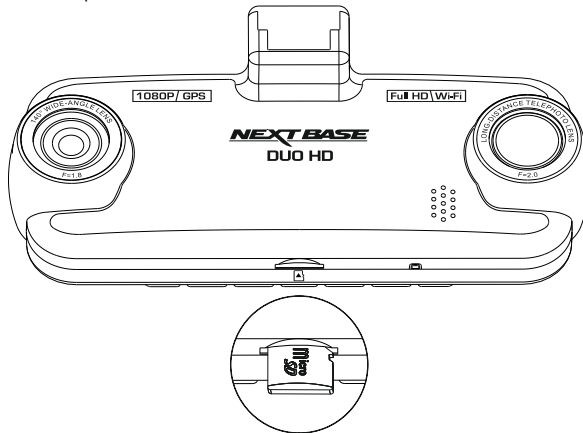

Note:

- Use the edge of a small coin (or similar object) to push the memory card in place if required. Take care that card has 'clicked' into place, a second push inwards will release the memory card.
- Do not remove or insert the memory card when the Dash Cam is turned on. This may damage the memory card.

### 2. Remove dust cover from Dash Cam

Remove the dust cover that is located on the top of the Dash Cam to gain access to the mounting point.

To remove the dust cover, slide it forwards away from the LCD screen of the Dash Cam.

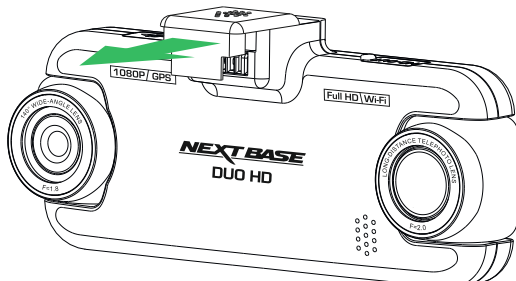

Note:

- If the Dash Cam is not to be used for a period of time please replace the dust cover to help keep the metal contacts free of dust or other contaminants.

**IN VEHICLE INSTALLATION (CONTD.)****3. Attach the mount to the Dash Cam**

Slide the Dash Cam onto the mount. Once attached magnets within the mount will hold the two parts together.

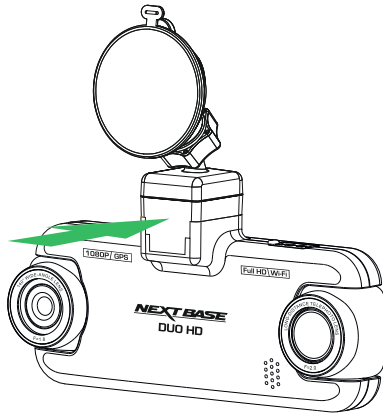
**4. Attach the mount to the windscreen**

Remove the protective plastic film from the suction cup of the mount.

Select a suitable position for the mount and clean the windscreen with a dry / clean cloth to achieve a good contact between the glass and suction cup.

Release the locking lever of the mount by pulling down and then whilst holding the suction cup onto the glass push the lever up to secure the mount to the windscreen.

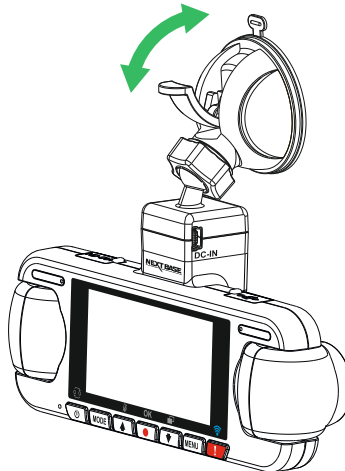

To use the supplied adhesive mount, simply unscrew the locking ring and pull the mount apart. Replace the sucker mount, remembering to tighten the locking ring securely.

Note:

- Choose a smooth glass area without painted effect.
- Please ensure that once mounted the Dash Cam will be located within the area of the vehicles windscreen wipers to maintain a clear view during rainfall.

## IN VEHICLE INSTALLATION (CONTD.)

### 5. Connect car power cable

Connect the supplied car power cable to DC-IN socket of the mount.

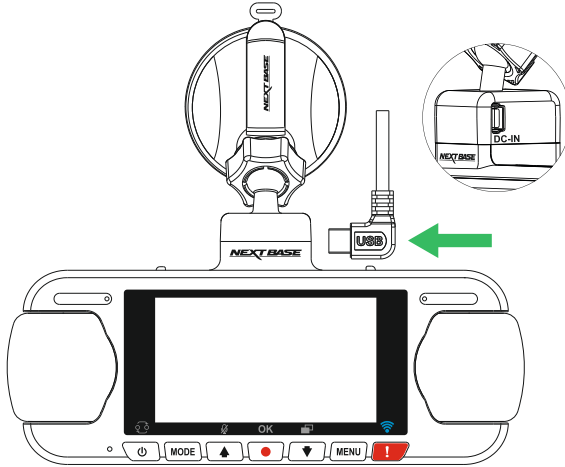

Plug the power cable into the 12-24Vdc outlet of your vehicle.

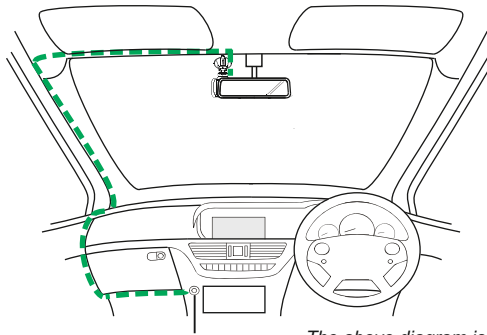

**12-24V DC**

*The above diagram is for illustration purposes only.*

The Dash Cam will automatically power on and start recording once power is available. In some vehicles this will be when connections are made, for others the Dash Cam will power on once the ignition has been turned on.

Should your vehicle not have a 12-24Vdc outlet, but does have a 5Vdc USB Outlet, this can be used instead. Connect the USB cable supplied with your Dash Cam in place of the car power cable. Ensure that the USB cable is connected to the mount and NOT directly to the Dash Cam.

#### Note:

- Do NOT wire the Dash Cam directly to a 12V supply by cutting the cigarette plug off the end of the cable, or damage will result.
- A Nextbase hardware kit is available from your retailer. This connects directly to the vehicle fusebox and hence leaves your cigarette socket available for Phone / Sat Nav charging. The Nextbase hardware kit includes the necessary 12-24VDC to 5Vdc convertor and battery protection circuitry.

## IN VEHICLE INSTALLATION (CONTD.)

Please read and follow the notes below for the safe operation of your Dash Cam within your vehicle.

As per the installation instructions, you must install the Dash Cam so it does NOT obstruct the drivers view of the road, preferably on the passenger side of the vehicle and behind the rear view mirror. Whilst the Dash Cam clearly needs to view through the windscreen in an area swept by the windscreen wipers, the Dash Cam should be installed so as not to intrude significantly within the wiped area. A 40mm intrusion into the green wiped area is the maximum permitted by law.

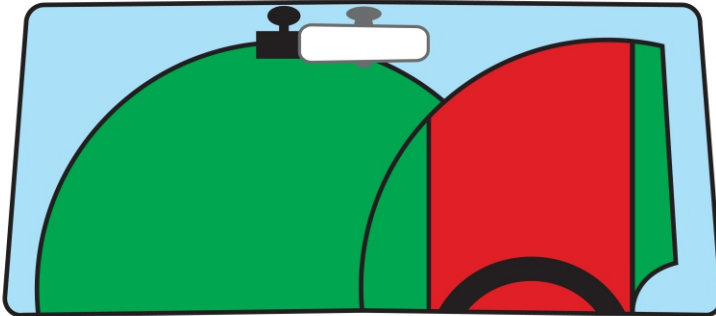

Do NOT mount the Dash Cam in front of the driver, as depicted by the red area in the above illustration.

When installing the Dash Cam in a vehicle, always place the device securely against the windscreen and where possible conceal the power cable under trim. Make sure that the Dash Cam power cable does not interfere with the drivers operating controls, such as the steering wheel, pedals or gear levers.

Do NOT mount the Dash Cam in front of an airbag field of deployment or in a position to obscure any mirrors.

Clean the windscreen at the point of location, prior to fitting the Dash Cam, also, applying some moisture to the suction cup may be beneficial, to ensure absolute adhesion.

It is recommended NOT to operate the Dash Cam whilst driving. The automatic Start - Stop technology incorporated within the device negates any need to operate the controls whilst driving.

Adjust any settings or review recordings whilst stationery, not whilst driving.

Only use your mobile device whilst stationery, not whilst driving.

After the preliminary SETUP has been carried out upon the Dash Cam, adjust the Screen Saver setting to 1 minute, this will blank the screen automatically shortly after starting the vehicle and therefore the screen will NOT be a distraction in any way to the driver.



## FIRST TIME USE

To ensure the set up of this Dash Cam is as quick and simple as possible, there is an easy to follow 'first Time Use' menu.

This menu is used to set your preferred Language, Country (this defines your time zone) and speed units.

The menu is available when -

- 1) The Dash Cam is first turned on.
- 2) There has been a firmware update applied to the Dash Cam.
- 3) After the Dash Cams settings have been reset, by using the 'Defaults Settings' option and it has been powered off and on again.

Simply follow the on screen instructions to select the Language, Country and Speed Units. The settings that influence the displayed time & date will be applied upon receiving a GPS connection.

Note:

- Whilst the first Time Use menus adjust the settings within the Dash Cam, the settings can still be adjusted thereafter, by using the normal Setup Menu options. Changing country location is one such example of a change you could make, after the first Time Use setup.

## DAYLIGHT SAVING TIME

### Daylight Saving Time (DST)

When necessary please remember to update the Time Zone / DST setting to allow for Daylight Saving Time (DST) or commonly referred to as British Summer Time.

For example, 2017 Daylight Saving Time in the United Kingdom is applied from 26th March to 29th October, simply adjust the Time Zone / DST setting to GMT+1 for the duration and then back to GMT for the remainder of the year.

The Time Zone / DST options are found within the Setup Menu.

## VIDEO MODE

The key below explains the various information displayed on the screen when your Dash Cam is in Video mode, some icons will only be displayed once the relevant function has been selected within the Video menu, as described below.



1. Recording: appears on screen when recording is in progress.
2. Camera: shows current camera selection.
3. Parking Mode: appears on screen when Parking Mode has been turned on.
4. Microphone: displayed on screen when Audio Recording is active.
5. GPS: The satellite icon will flash whilst the Dash Cam locates satellites. Once a stable signal is received, the icon will stop flashing and remain on screen.
6. Protected: shown on screen when a video file has been protected by activation of the G Sensor or by the pressing of the file protect button.
7. Date: shows current date.
8. Time: shows current time.
9. Battery: indicates whether Dash Cam is running on battery or external power.

The default settings within the Dash Cam have been set to allow you to use the Dash Cam without the need to change any settings.

See the next page for video menu settings, should you want to make any adjustments however.

## VIDEO MODE (CONTD.)

### Video Menu

The Video Menu is accessed by pressing the MENU button whilst in video mode.

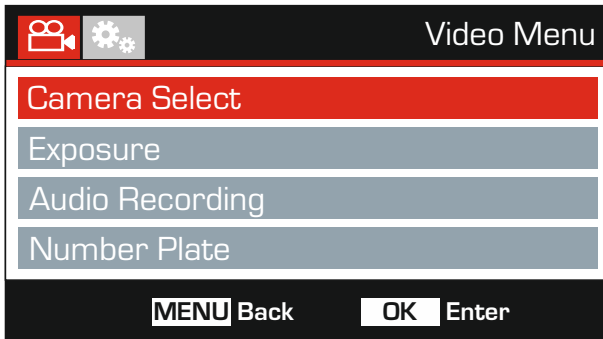

The default settings have been carefully selected to allow you to use the Dash Cam without the need to change any settings. However, should you wish to change a setting then please see below.

Use the up and down buttons to highlight the function that you'd like to change and press the OK button to enter the settings sub-menu.

Once in the sub-menu, use the up and down buttons to highlight the required setting and then press OK to confirm your selection and return to the Video Menu.

Press the MENU button twice to return to video mode.

Note:

- Menus are not accessible whilst the Dash Cam is recording.

#### 1. Camera Select

Select which camera configuration to apply - Dual, Left (wide angle) only or Right (zoom) only.

Options: Dual, Left and Right

Default Setting: Dual

#### 2. Exposure

Adjust exposure level for different light conditions.

Options: +2, +1, 0, -1 and -2

Default Setting: 0

## VIDEO MODE (CONTD.)

Continued from previous page.

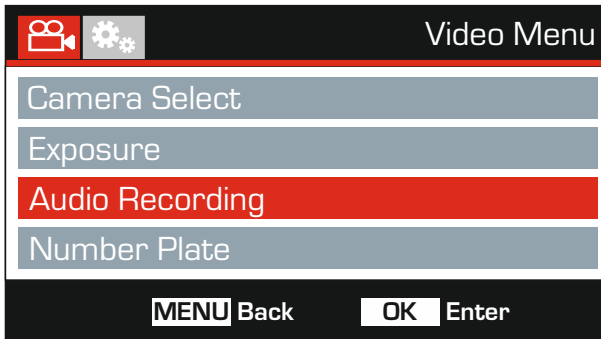

### 3. Audio Recording

Turn On / Off the microphone.

Options: On and Off

Default Setting: On

### 4. Number Plate

Enter the registration number for your vehicle, this will then be shown on the video file.

**VIDEO MODE (CONTD.)**

Continued from previous page.

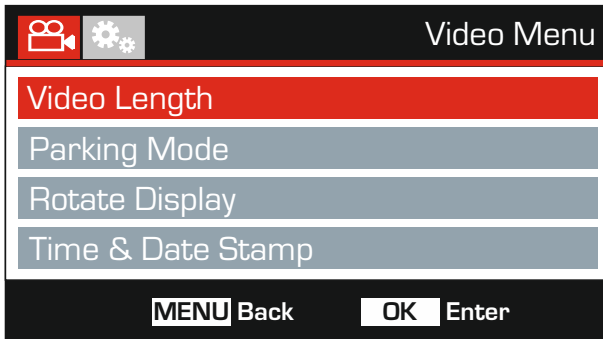
**5. Video Length**

Select the duration of the individual recorded video files. The Dash Cam will continue recording, filling the memory card. When the memory card becomes full, the oldest file will be automatically deleted to make space for the new recording.

Note:

- Protected files will never be deleted.

Options: 2 Minutes, 3 Minutes and 5 Minutes

Default Setting: 3 Minutes

**6. Parking Mode**

When Parking Mode has been turned on, the Dash Cam enters standby mode when the 12Vdc supply has been turned OFF (typically removing your ignition key).

The Dash Cam will also enter standby mode if no physical movement is detected for 5 minutes, this is designed to allow use of a permanent 12Vdc supply, i.e. hard-wire kit.

Should physical movement of the vehicle be detected, the Dash Cam will power on and start recording a 2 minute protected video. If no further physical movement is detected then The Dash Cam will return to standby mode, if physical movement is detected subsequently, then the camera will continue to record normally, i.e. driving once more.

Options: On and Off

Default Setting: Off

## VIDEO MODE (CONTD.)

Continued from previous page.

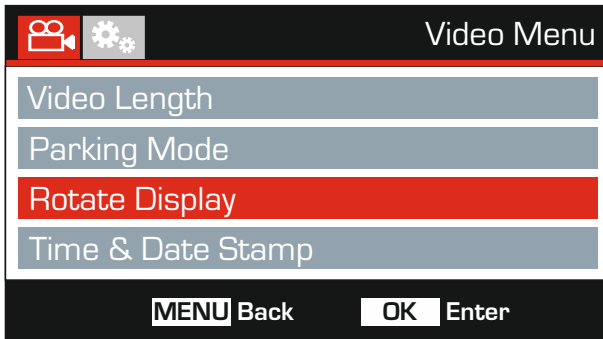

**7. Rotate Display**

Rotate the display 180°, particularly useful should the Dash Cam be mounted on the dashboard, the Dash Cam control button functions do not rotate.

**8. Time & Date Stamp**

Turn On / Off the time and date stamp shown on recorded files.

Options: Off and On

Default Setting: On

## VIDEO MODE (CONTD.)

Continued from previous page.

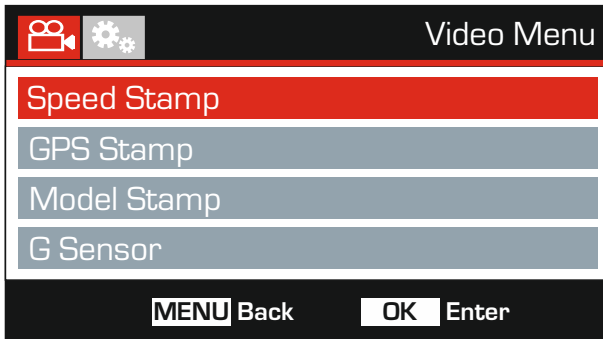

**9. Speed Stamp**

Turn On / Off the Speed Stamp shown on recorded files.

Options: On and Off

Default Setting: On

**10. GPS Stamp**

Turn On / Off both the GPS co-ordinates and speed stamp that are shown on recorded files. When a recording is viewed using the supplied NEXTBASE Replay playback software both the GPS co-ordinates and speed information remains available.

Options: On and Off

Default Setting: On

**VIDEO MODE (CONTD.)**

Continued from previous page.

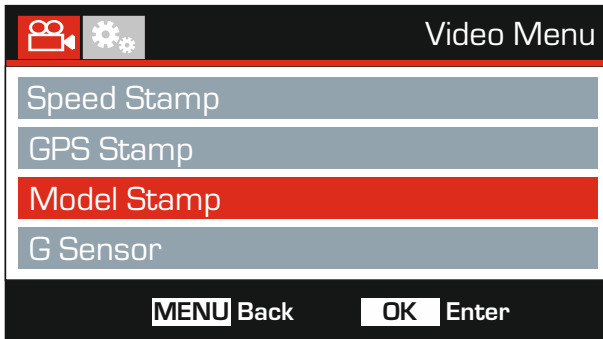
**11. Model Stamp**

Turn On / Off the Model Number stamp shown in the bottom left corner of recorded files.

Options: On and Off  
Default Setting: On

**12. G Sensor**

Turn Off or adjust the sensitivity of the built in G Sensor. The G Sensor detects forces which will automatically protect the current recording in event of a collision.

Note:  
- This does not affect Parking mode sensitivity.

Options: High, Medium, Low and Off  
Default Setting: Medium

Note:

- Within the Setup Menu which is accessed by pressing the MENU button twice, there is a 'Default Settings' option to allow you to reset the Dash Cam to the factory defaults, if required.



## PHOTO MODE

Press the MODE button to select Photo mode.

The key below explains the information displayed on the screen when your Dash Cam is in Photo mode.

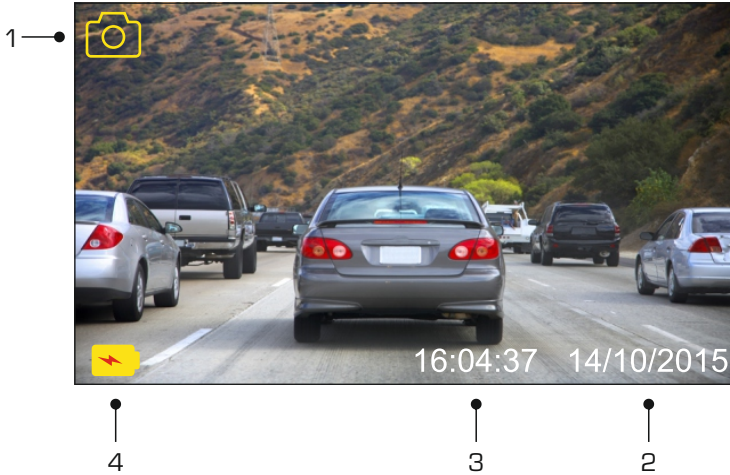

1. Mode: indicates the Dash Cam is in Photo mode.
2. Date: shows current date.
3. Time: shows current time.
4. Battery: indicates whether Dash Cam is running on battery or external power.

See the next page for photo menu settings.

## PHOTO MODE (CONTD.)

### Photo Menu

The Photo Menu is accessed by pressing the MENU button whilst in photo mode.

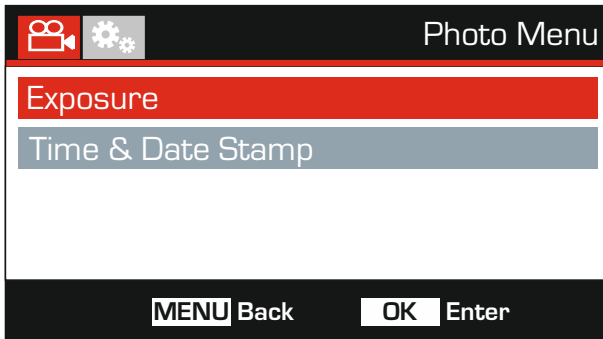

The default settings have been carefully selected to allow you to use the Dash Cam without the need to change any settings. However, should you wish to change a setting then please see below.

Use the up and down buttons to highlight the function that you'd like to change and press the OK button to enter the settings sub-menu.

Once in the sub-menu, use the up and down buttons to highlight the required setting and then press OK to confirm your selection and return to the Photo Menu.

Press the MENU button twice to return to photo mode.

#### 1. Exposure

Adjust exposure level for different light conditions.

Options: +2, +1, 0, -1 and -2

Default Setting: 0

#### 2. Time & Date Stamp

Turn On / Off the time and date stamp shown on images.

Options: On and Off

Default Setting: On

#### Note:

- Within the Setup Menu which is accessed by pressing the MENU button twice, there is a 'Default Settings' option to allow you to reset the Dash Cam to the factory defaults, if required.

## PLAYBACK MODE

### Playback Menu

To access Playback Mode press the MODE button twice, from the default VIDEO Mode.

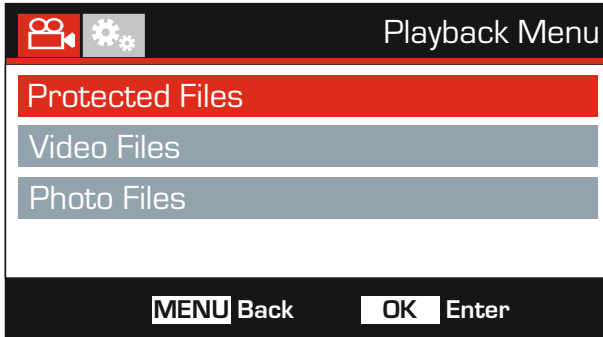

### Directories

The Dash Cam files available on the memory card will be categorized into three directories.

#### Protected Files:

Video files that have been protected by either activation of the G Sensor or by pressing of the 'Protect' button will be available within this directory.

#### Video Files:

All unprotected video files will be available within this directory.

#### Photo Files:

Still images will be available within this directory.

Use the Up and Down buttons to highlight required selection and press the OK button to enter.

## PLAYBACK MODE (CONTD.)

Dependent on the type of file, the on-screen information and playback functions differ.

Video files:



1. Mode: indicates the Dash Cam is in Playback mode.
2. File type: indicates whether a video or photo file is being viewed.
3. File name: displays current file number.
4. Elapsed time: Displays the elapsed time for the video being watched.
5. Time: displays the start time that the current file was recorded.
6. Date: displays date that the current file was recorded.
7. Playback controls: use the Dash Cam buttons as described below.
8. Battery: indicates whether Dash Cam is running on battery or external power.
9. Protected file: indicates that the video file is protected.
10. File Number: shows file number and the number of files available.

Playback Controls:

- |                |   |
|----------------|---|
| <b>OK:▶/II</b> | Press the OK button to play / pause playback.   |
| <b>MODE:■</b>  | Press the MODE button to stop playback.   |
| <b>▲:PREV</b>  | Use the UP button to select the previous file, this is only available once playback has been stopped. |
| <b>▲:◀◀</b>    | During playback press the UP button to rewind, press the DOWN button to cancel.                       |
| <b>▼:NEXT</b>  | Use the DOWN button to select the next file, this is only available once playback has been stopped.   |
| <b>▶▶:▼</b>    | During playback press the DOWN button to fast forward, press the UP button to cancel.                 |

## PLAYBACK MODE (CONTD.)

Photo files:



1. Mode: indicates the Dash Cam is in Playback mode.
2. File type: indicates whether a video or photo file is being viewed.
3. File name: displays current file number.
4. Time: displays the time that the current image was taken.
5. Date: displays the date that the current image was taken.
6. Next: press the down button to move to next file.
7. Previous: press the up button to move to previous file.
8. Battery: indicates whether Dash Cam is running on battery or external power.
9. Protected file: indicates that the video file is protected.
10. File Number: shows file number and the number of files available.

Within Playback mode there are options available to Delete and Protect files, press the MENU button to access the Playback Menu.

See following pages for details.

## PLAYBACK MODE (CONTD.)

### Deleting files:

Highlight the Delete files option and press the OK button.

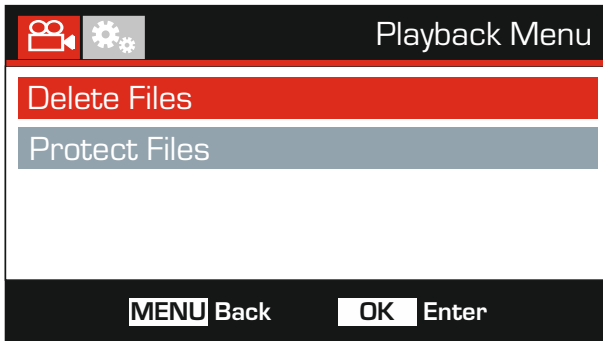

This will then give you two options:

### Delete File

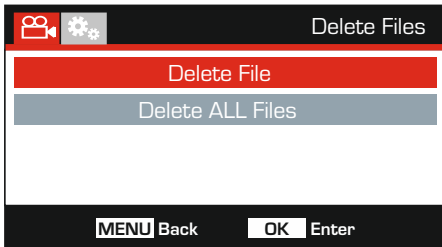

Once selected, follow the on screen instructions to delete the current file.

### Delete ALL Files

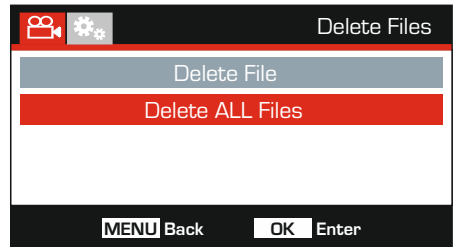

Once selected, follow the on screen instructions to delete all files.

### Note:

- Protected files cannot be deleted.

## PLAYBACK MODE (CONTD.)

### Protecting files:

Highlight the Protect files option and press the OK button.

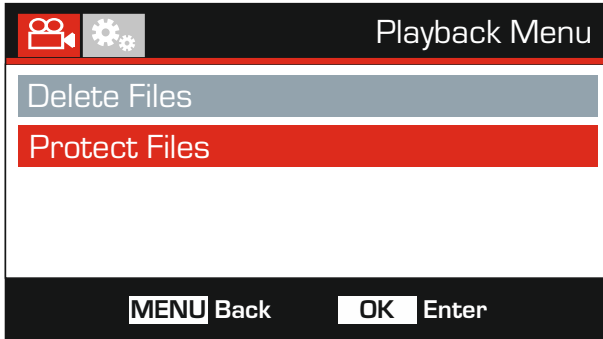

This will then give you two options:

### Protect File

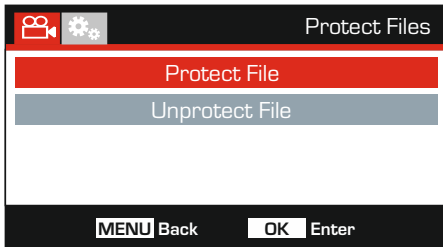

Once selected, follow the on screen instructions to Protect the current file

### Unprotect File

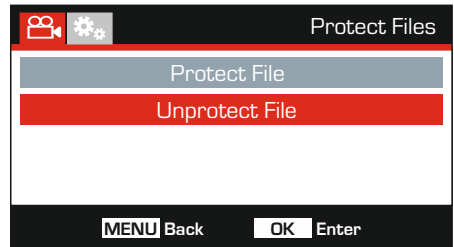

Once selected, follow the on screen instructions to Unprotect the current file.

### Note:

- The 'Protect' button can also be used to Protect files when in Playback Mode.
- Protecting and Unprotecting recordings when in Playback Mode will move the recording to the appropriate directory.  
For example: if a Protected file is changed to be Unprotected, then it will move to the 'Video Files' directory.

## SETUP MENU

### Setup Menu

The Setup Menu is accessed by pressing the MENU button twice.

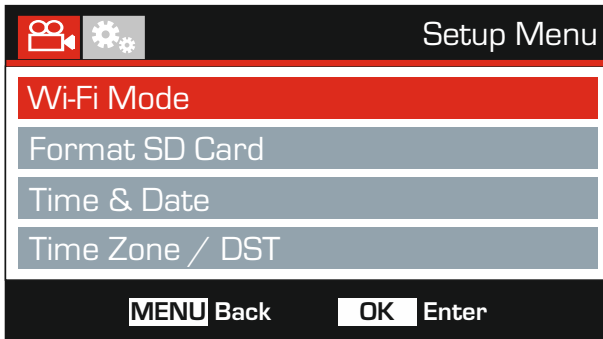

The default settings have been carefully selected to allow you to use the Dash Cam without the need to change any settings. However, should you wish to change a setting then please see below.

Use the up and down buttons to highlight the function that you'd like to change and press the OK button to enter the settings sub-menu.

Once in the sub-menu, use the up and down buttons to highlight the required setting and then press OK to confirm your selection and return to the Photo Menu.

Press the MENU button twice to return to video mode.

#### 1. Wi-Fi Mode

The Wi-fi function allows you to use your smartphone or tablet device to view and or download recordings directly from the Dash Cam.

#### 2. Format SD Card

Format the inserted memory card, this will delete all content.

Note:

- For stable performance, it is recommended that you format the memory card every 2-3 weeks.

Of course, you should only do this AFTER you've downloaded any files from the card that you may want to keep.

#### 3. Time & Date

Adjust the time / date as required using the OK button to toggle through the fields and use the up & down buttons to set variables. Press MENU to exit and return to the Setup Menu. The time and date will however be set accurately when Satellite reception is achieved.

#### 4. Time Zone / DST

The Time and Date are automatically set based on the Country selected from within the first Time Use menu.

The Time Zone / DST options are used should you want to manually select a Time Zone that falls outside of the available Country options or allow for Daylight Saving Time.



**SETUP MENU (CONTD.)**

Continued from previous page.

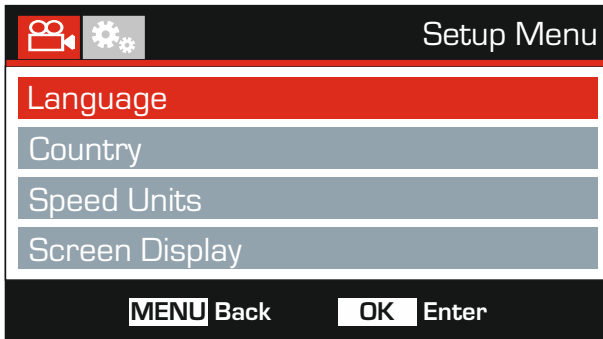
**5. Language**

Select preferred language.

Options: English, Danish, Dutch, Finnish, French, German, Italian, Norwegian, Spanish and Swedish  
Default Setting: English

**6. Country**

Select your current Country, this will then automatically adjust the Time Zone / DST setting to your Time Zone, i.e. if France is selected the Time Zone will become GMT +1.

If your required Country is not available, select 'Other'. This will take you to the 'Time Zone / DST' menu, from there you can manually select your Time Zone.

Options: United Kingdom, Belgium, Denmark, Finland, France, Germany, Italy, Netherlands, Norway, Poland, Spain, Sweden and Other  
Default Setting: United Kingdom

**7. Speed Units**

Select whether to record and display speed in KMH or MPH.

Options: KMH and MPH  
Default Setting: MPH

**8. Speed Display**

When turned on, the screen will display current speed after 30 seconds of button inactivity, press any button to return to normal viewing, this function is only available when a GPS connection is present.

Options: On and Off  
Default Setting: Off

**SETUP MENU (CONTD.)**

Continued from previous page.

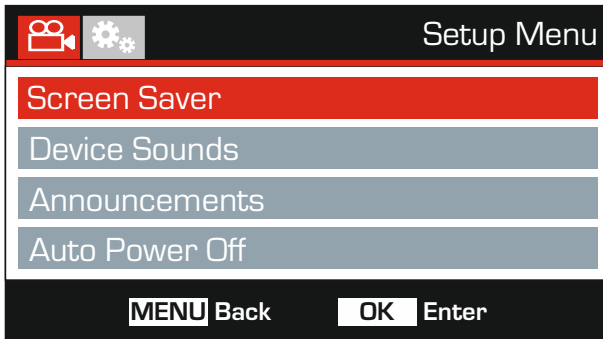
**9. Screen Saver**

Turn on the Screen Saver function to shut down the screen after 30 seconds of button inactivity, press any button to re-activate the display.

Note:

- If the Speed Display function has been turned on, then Screen Saver will not be available.

Options: On and Off

Default Setting: Off

**10. Device Sounds**

Turn Off / On the beep sound which is heard when a button is pressed and also mute the startup and shutdown chimes.

Options: On and Off

Default Setting: On

**11. Announcements**

Turn Off / On the spoken Announcements.

The spoken announcements provide an audible confirmation of the button that has been pressed and its function. The announcements also serve as positive confirmation after a file has been protected due to G-Sensor activation during recording.

Options: On and Off

Default Setting: Off

Note:

- Announcements are currently only available in English.

- Turning on Announcements will turn off the Device Sounds.

**12. Auto Power Off**

Adjust the timing of the Auto Power Off function, this can be used to continue recording in event of loss of power within the vehicle.

Options: 10 Seconds, 1 Minute and 2 Minutes

Default Setting: 10 Seconds

## SETUP MENU (CONTD.)

Continued from previous page.

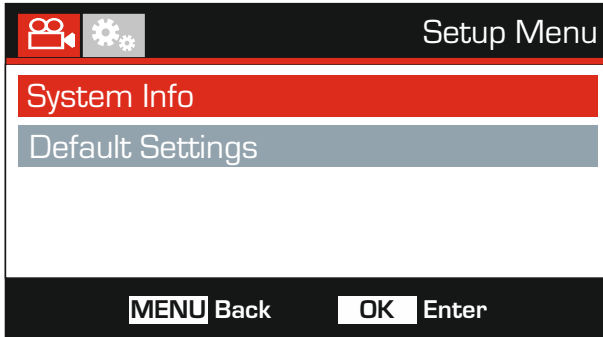

### 13. System Info

Version:

The installed software version of your Dash Cam is displayed here.

Wi-Fi Info:

View the SSID (network name) and Password of your Dash Cam.

### 14. Default Settings

Reset the Dash Cam to the default settings.

## PC CONNECTION

Use the supplied USB cable to connect the Dash Cam directly to your PC via the  socket, do NOT connect the USB cable to the Powered Mount.

Once connected the Dash Cam will turn on with three options available, as described below.

- Mass Storage
- Power On
- Update

Use the UP and DOWN buttons to select required function and press OK to confirm selection.

### Mass Storage (Windows)

When this option is selected, the Dash Cam will function as a card reader for your PC. An extra drive will appear, e.g. Removable Disk (D:) and you will be able to view / manage the stored files upon the MicroSD card within the Dash Cam.

Note:

- The Dash Cam is a 'read-only' device, therefore uploading files to the SD card when in Mass Storage mode is not possible.

Turn off the camera before disconnecting from your computer.

### Mass Storage (Mac)

When this option is selected, the Dash Cam will function as a card reader for your MAC. The Dash Cam will be seen as an external disk upon your MAC and you will be able to view and/or manage stored files.

Note:

- The Dash Cam is a 'read-only' device, therefore uploading files to the SD card when in Mass Storage mode is not possible.

Turn off the camera before disconnecting from your computer.

### Power On (Windows & Mac)

When this option is selected, the Dash Cam will power on with all functions available. This includes charging of the internal battery, a full charge will take approximately 2 hours.

Note:

- ALWAYS turn Off the Dash Cam before disconnecting from your computer.

### Update (Windows and Mac)

When this option is selected, it is for use with the NEXTBASE Replay 3 Playback software in order to update the firmware within the Dash Cam to the latest version.

Please see details within the NEXTBASE Replay 3 Playback software for more information.

## TV CONNECTION

The Dash Cam can be connected to an external display by using the HD Out socket, this is to allow the viewing of recordings directly from the Dash Cam on a large television.

When you connect a compatible High Definition cable (sold separately) between the Dash Cam and your television, the Dash Cam screen will blank. This is normal, as all output is now visible upon your television.

Please contact your local NEXTBASE dealer for accessory purchases.

Please note that recording is NOT available whilst using the HD Out function.

Note:

- Turn off the Dash Cam before disconnecting the HD cable.
- An external power supply may be required when viewing recordings via the HD output of the Dash Cam, e.g. using the supplied USB cable with a 5Vdc/USB adaptor, of the type typically supplied with mobile phones.
- ENSURE that any external power sources are of the correct 5Vdc output, otherwise damage will be caused that is not covered under the manufacturer's warranty.

## TROUBLE SHOOTING

PROBLEM	SOLUTION
The sucker will not stay in place upon my windscreen.	Ensure that the protective cover (plastic film) has been removed from the suction pad. Moisten the sucker slightly before affixing upon the windscreen. Ensure that the locking lever is fully open when the sucker is pushed on to the windscreen and then close the lever. Make sure that the glass is smooth and clean. Do not stick to glass that has any non-smooth effect or paint whatsoever. Affix to the glass firmly and then close the locking lever fully.
I cannot insert the MicroSD card.	MicroSD card are very small and require delicate use. Align the card with the diagram shown upon the Dash Cam and insert the card until you feel a slight spring resistance. You now need to push the card, using your finger nail, until you hear and feel a small latch. Release pressure and the card will stay retained within the device. Use the edge of a small coin if you have difficulty.
I cannot remove the MicroSD card.	With the card previously installed, you now need to push the card further inwards slightly, using your finger nail, until you hear and feel a small latch. Use the edge of a small coin if you have difficulty. Release pressure and the card will spring out sufficiently for you to take hold of it.
I can only record a few minutes of video on my MicroSD card.	Change the recording size (Video Length function) to a smaller size. Increase the size of the MicroSD card. Max 128GB.
I cannot save files to the memory card when the Dash Cam is connected to my computer under Mass Storage mode.	Correct, the Dash Cam is a 'read-only' device. It is not recommended to save files from other sources to the same memory that you will use for recording within the Dash Cam, as these may have a negative effect on the performance of the Dash Cam.
No power to my Dash Cam, but it works upon my PC.	The cigarette power cable is not working. Inspect the fuse in the Car Power plug. Replacement fuse = 2A 20mm type. If the fuse is found to be blown, inspect the power cable for damage which may have caused the fuse blow.
My Dash Cam shuts down by itself after a while.	Either the battery has gone flat, there is no power to the Dash Cam and the Auto Power Off period has been triggered or Parking Mode has been turned on and no vehicle movement has been detected for 5 minutes.
The screen blanks after a few minutes upon my Dash Cam.	The screen saver is set to ON. Change settings to OFF if required. Default setting is off.
The battery will not charge.	Ensure the Dash Cam is connected to a reliable power source and that the supplied Car Power Cable is being used, with the Power LED lit.

**TROUBLE SHOOTING (CONTD.)**

PROBLEM	SOLUTION
The battery only last 30 seconds.	The battery will only receive charge when the Dash Cam is connected to power, please reconnect the car adaptor or domestic USB charger and leave the Dash Cam to charge. Charging takes approximately 90 minutes and a full charge is indicated when the BLUE [charging] LED goes out.
The battery only lasts 30 minutes.	This is normal, the battery design allows the 'Auto Power Off' feature to function in event of power loss within the vehicle. It is not intended as an alternative power source to replace the supplied car adaptor.
The Dash Cam cannot lock onto satellite.	After power on and with the device mounted with clear view of the sky it can take up to 10 minutes to find the three satellites required to achieve a stable signal. Reception can also be affected by atmospheric conditions and the proximity of buildings / trees obscuring the sky.
I get the message "SD Card Error. Please format SD card" on screen.	The SD card has been formatted in another device and the Cluster Size is not compatible or the SD card is formatted in ExFAT / NTFS. There may also be an error on the card. Use the Setup option to re-format the SD card from within the Dash Cam.
I get the message "Card Full" on screen.	The SD card has become full as there may be too many protected files which will not be deleted to allow for further recording to take place. Delete unnecessary files or perform a full FORMAT upon the SD card from within the Dash Cam Setup Menu.
The SD card in my Dash Cam cannot be read.	Use a good quality branded SD card between 8GB and 128GB (Class 10 or UHS type 1) and format the card from within the Setup Menu.
I can't delete files on my SD card within the Dash Cam.	Check to see if these files are 'protected', if so please follow instructions to 'un-protect'.
Mass Storage function does not work.	The Mass storage function will work on both Windows and Mac. Restart the PC, as this may be required for the necessary driver to be loaded correctly. Disconnect and reconnect the Dash Cam. Contact NEXTBASE for the required driver.
Video files cannot be played.	The video files from the iN CAR CAM are in .MOV format and may not be compatible with your PC if suitable playback software is not installed.
Video Image is blurred.	Remove the protective lens cover, clean the lens, clean the windscreen!

**TROUBLE SHOOTING (CONTD.)**

PROBLEM	SOLUTION
Video file playback is jumpy.	Remove the SD card and reformat to remove non-contiguous files. For best recording use a quality branded class 10 type (48MB/s) or UHS type 1 micro SD card of 8 to 128GB recommended size. PC may not be sufficient for the playback task, try a different PC. Copy the recorded video files onto the PC / Mac for playback directly rather than use the Dash Cam as a card reader, as the USB system on your PC may be too slow for HD video playback. Reduce the resolution of the recording within the Dash Cam and record some new files to test if this is the problem.
The sound is not synchronised with video during playback.	The Codecs upon your PC may not be compatible or the latest standard. Download the latest Codecs from: <a href="http://www.nextbase.co.uk">www.nextbase.co.uk</a>
Video has no sound.	Ensure that "Record Audio" setting is turned ON within the Video Menu of the Dash Cam.
Photograph is blurred.	Hold the camera still whilst taking the photo. Please be aware the photo is taken around 1 second after the shutter noise is heard.
I have turned on 'Parking Mode' and now can't stop the recording.	The Dash Cam will start a recording whenever motion is detected. To turn off Parking Mode firstly shutdown the Dash Cam and remove the SD card, this will avoid recording being activated accidentally. Switch the Dash Cam On and within the Setup Menu, turn off the 'Parking Mode'.
When I get in to my car, the Dash Cam is already recording and the file is protected.	This is normal. Parking Mode has been switched on and the Dash Cam has sensed vibration and has started to record correctly. Parking mode can be turned off within the Video menu if required.
When I press the MENU button nothing happens.	This is normal during recording. Stop the recording before pressing the MENU button. If recording re-starts before you can press MENU, then see the Parking Mode section above.
The time on my Dash Cam is wrong and when I adjust the time manually, it keeps changing.	The Dash Cam sets the time based upon the country which has been selected and also whether Daylight Savings time is currently in force. Please verify the Country setting within the menu is correct. The Time Zone can be set manually, if the Dash Cam is to be used outside the listed countries in the Setup Menu.
Downloading files from <a href="http://www.nextbase.co.uk">www.nextbase.co.uk</a> using Google Chrome results in a Malicious Software message.	This is not a cause for concern, simply go to the settings within Google Chrome and turn off the malicious software protection temporarily to download and install the playback software. Reinstate previous Google Chrome settings thereafter.



## TROUBLE SHOOTING (CONTD.)

PROBLEM	SOLUTION
My Mobile Device will not connect to my camera.	Please ensure that you have turned the Dash Cam Wi-fi Mode on by either using the Wi-fi button or through the Settings Menu. When Wi-fi Mode is turned on the screen of the Dash Cam will display the Network Name and Password. This password is case sensitive.
The NEXTBASE Cam Viewer app will not open.	Please uninstall the NEXTBASE Cam Viewer app and re-download again from your devices App Store.
When I open the NEXTBASE Cam Viewer App I get a message saying 'Please Check Device'.	Ensure that the Dash Cam is in Wi-fi Mode and that your mobile device has connected to the Dash Cam Wi-fi connection.
When I try to play back a file from my Dash Cam I get a message saying 'Buffering' but the video does not load.	Please restart your mobile device and reconnect to the Dash Cam Wi-fi connection. Then re-open the Cam Viewer App.
Unresolved issues.	Reset the Dash Cam to the Default Settings within the Setup Menu and try again. Should the problem persist call the helpline (02920) 866429 or email: <a href="mailto:support@nextbase.co.uk">support@nextbase.co.uk</a>

**NOTES**

# ***NEXT BASE***

[www.nextbase.co.uk](http://www.nextbase.co.uk)

