

SHARP®

LC-39LE650E/V	LC-50LE650E/V	
LC-39LE651E/K/V	LC-50LE651E/K/V	LC-60LE651E/K
LC-39LU651E	LC-50LU651E	LC-60LU651E
LC-39LE652E/V	LC-50LE652E/V	LC-60LE652E
LC-39LM652E/V	LC-50LM652E	LC-60LM652E
LC-39LK652E	LC-50LK652E	LC-60LK652E
LC-39LX652E	LC-50LX652E	LC-60LX652E
LC-39LE654E/V	LC-50LE654E/V	LC-60LE654E

LCD COLOUR TELEVISION
LCD-FARBFERNSEHGERÄT
TÉLÉVISEUR COULEUR À ÉCRAN
CRISTAUX LIQUIDES (LCD)
TELEVISORE A COLORI LCD
LCD-KLEURENTELEVISIE
TELEVISIÓN EN COLOR LCD
TELEVISOR DE CRISTAL LÍQUIDO

OPERATION MANUAL
BEDIENUNGSANLEITUNG
MODE D'EMPLOI
MANUALE DI ISTRUZIONI
GEBRUIKSAANWIJZING
MANUAL DE INSTRUCCIONES
MANUAL DE OPERAÇÃO

AQUOS **NET+**
AQUOS **3D**
LED



ENGLISH

DEUTSCH

FRANÇAIS

ITALIANO

NEDERLANDS

ESPAÑOL

PORTUGUÊS



DivX®

DivX Certified® to play DivX® video up to HD 1080p, including premium content.

ABOUT DIVX VIDEO: DivX® is a digital video format created by DivX, LLC, a subsidiary of Rovi Corporation. This is an official DivX Certified® device that plays DivX video. Visit divx.com for more information and software tools to convert your files into DivX videos.



ABOUT DIVX VIDEO-ON-DEMAND: This DivX Certified® device must be registered in order to play purchased DivX Video-on-Demand (VOD) movies. To obtain your registration code, locate the DivX VOD section in your device setup menu. Go to vod.divx.com for more information on how to complete your registration.

Covered by one or more of the following U.S. Patents:

7,295,673; 7,460,668; 7,515,710; 7,519,274

- YouTube and the YouTube logo are trademarks of Google Inc.

SPECIAL NOTE FOR USERS IN THE U.K.

The mains lead of this product is fitted with a non-rewireable (moulded) plug incorporating a 13A fuse. Should the fuse need to be replaced, a BSI or ASTA approved BS 1362 fuse marked  or  and of the same rating as above, which is also indicated on the pin face of the plug, must be used.

Always refit the fuse cover after replacing the fuse. Never use the plug without the fuse cover fitted.

In the unlikely event of the socket outlet in your home not being compatible with the plug supplied, cut off the mains plug and fit an appropriate type.

DANGER:

The fuse from the cut-off plug should be removed and the cut-off plug destroyed immediately and disposed of in a safe manner.

Under no circumstances should the cut-off plug be inserted elsewhere into a 13A socket outlet, as a serious electric shock may occur.

To fit an appropriate plug to the mains lead, follow the instructions below:

IMPORTANT:

The wires in the mains lead are coloured in accordance with the following code:

Blue: Neutral

Brown: Live

As the colours of the wires in the mains lead of this product may not correspond with the coloured markings identifying the terminals in your plug, proceed as follows:

- The wire which is coloured blue must be connected to the plug terminal which is marked N or coloured black.
- The wire which is coloured brown must be connected to the plug terminal which is marked L or coloured red.

Ensure that neither the brown nor the blue wire is connected to the earth terminal in your three-pin plug.

Before replacing the plug cover make sure that:

- If the new fitted plug contains a fuse, its value is the same as that removed from the cut-off plug.
- The cord grip is clamped over the sheath of the mains lead, and not simply over the lead wires.

IF YOU HAVE ANY DOUBT, CONSULT A QUALIFIED ELECTRICIAN.

- The illustrations and the OSD in this operation manual are for explanation purposes and may vary slightly from the actual operations.
- The examples used throughout this manual are based on the LC-39LE650E model.
- The LC-39LE650E, LC-39LE651E/K, LC-39LE652E, LC-39LE654E, LC-50LE650E, LC-50LE651E/K, LC-50LE652E, LC-50LE654E, LC-60LE650E, LC-60LE651E/K, LC-60LE652E and LC-60LE654E models are compatible with high definition broadcasts, H.264 compressed (MPEG4 H.264, MPEG4 AVC, MPEG4 AVC/H.264).

Contents

Contents	1	Connecting a USB device	31
Introduction	2	TV menu options	32
Dear SHARP customer	2	TV/List function	32
Important Safety Precautions	2	Video function	34
Remote Control unit	3	Audio/Radio function	35
TV (Front view)	4	Photo function	36
TV (Side and rear view)	4	USB/HOME MEDIA device compatibility	36
Preparation	5	AQUOS NET+ function	37
Supplied accessories	5	Extras function	39
Attaching the stand unit	5	Setup function	40
Optional accessory	5	Connecting external devices	41
Fixing the TV on a wall.....	5	Introduction to connections	41
Inserting the batteries	6	HDMI connection	42
Using the remote control unit	6	Component connection	42
Cautions regarding the remote control unit	6	VIDEO connection	42
Quick guide	7	SCART connection	43
Initial installation overview	7	Speaker/amplifier connector	43
Before turning on the power	8	HDMI devices	44
Inserting a CA Card	8	Controlling HDMI devices using HDMI CEC	44
Initial auto installation	9	HDMI CEC connection	44
Positioning / aligning DVB-T antenna	14	HDMI CEC menu	44
Menu Operation	15	Operating a HDMI CEC device	44
What is the menu?	15	Connecting a PC	45
Common operations	15	PC connection	45
About the Guide Display	15	HDMI (DVI) connection	45
Info display	15	Analogue connection	45
Operation with the TV panel control keys	16	Adjusting the PC image automatically	46
Favourites	16	Adjusting the PC image manually	46
Watching TV	17	Multimedia/Network setup	47
Daily operation	17	Network Setup	47
Switching on/off	17	Connecting to the network	47
Switching between digital, satellite and analogue broadcasts	17	Wired installation	47
Changing channels	17	Wireless installation	47
Selecting an external video source	17	USB REC function	49
Selecting audio language	17	USB REC function	49
Subtitles	17	USB REC (Video Recorder)	49
EPG	18	Archive playback	49
EPG operation	18	USB REC settings	49
Other EPG functions	19	Archive playback settings	51
Teletext	20	TV viewing with time shift	53
Using MHEG-5 application (UK only)	20	Enjoying 3D Image Viewing	54
Basic adjustment	21	Enjoying 3D image viewing	54
TV set adjustments	21	Viewing 3D images	54
Picture settings	21	Recharging the 3D glasses battery	55
Sound settings	21	Display format for 3D and 2D images	56
Stations settings	22	Troubleshooting - 3D images	56
Control settings	24	Appendix	58
Software update via USB	27	Troubleshooting	58
Software update via Internet	27	Information on the software license for this product	58
Multimedia/Network settings	28	Environmental Specifications	58
Connections settings	28	Specifications	59
Channel list	29	End of life disposal	60
Useful viewing options	31	Trademarks	60
Selecting the picture format	31		
Setting when using external devices	31		

Introduction

Dear SHARP customer

Thank you for your purchase of the SHARP LCD colour TV product. To ensure safety and many years of trouble-free operation of your product, please read the Important Safety Precautions carefully before using this product.

Important Safety Precautions

- **Cleaning**—Unplug the AC cord from the AC outlet before cleaning the product. Use a damp cloth to clean the product. **Do not use liquid cleaners** or aerosol cleaners.
- Use a soft damp cloth to gently wipe the panel when it is dirty. To protect the panel, do not use a chemical cloth to clean it. Chemicals may cause damage or cracks in the cabinet of the TV.
- **Water and moisture**—Do not use the product near water, such as a bathtub, washbasin, kitchen sink, laundry tub, swimming pool or in a wet basement.
- Do not place vases or any other water-filled containers on this product. The water may spill onto the product causing fire or electric shock.
- **Stand**—Do not place the product on an unstable trolley, stand, tripod or table. Doing so can cause the product to fall, resulting in serious personal injuries as well as damage to the product. Use only a trolley, stand, tripod, bracket or table recommended by the manufacturer or sold with the product. When mounting the product on a wall, be sure to follow the manufacturer's instructions. Use only the mounting hardware recommended by the manufacturer.
- When relocating the product placed on a trolley, it must be moved with utmost care. Sudden stops, excessive force and uneven floor surface can cause the product to fall from the trolley.
- **Ventilation**—The vents and other openings in the cabinet are designed for ventilation. Do not cover or block these vents and openings since insufficient ventilation can cause overheating and/or shorten the life of the product. Do not place the product on a bed, sofa, rug or other similar surface, since they can block ventilation openings. This product is not designed for built-in installation; do not place the product in an enclosed place such as a bookcase or rack, unless proper ventilation is provided or the manufacturer's instructions are followed.
- The LCD panel used in this product is made of glass. Therefore, it can break when the product is dropped or impact applied. If the LCD panel is broken, be careful not to be injured by broken glass.
- **Heat sources**—Keep the product away from heat sources such as radiators, heaters, stoves and other heat-generating products (including amplifiers).
- **Headphones**—Do not set the volume at a high level. Hearing experts advise against extended listening at high volume levels.
- To prevent fire, never place any type of candle or naked flames on the top or near the TV set.
- To prevent fire or shock hazard, do not place the AC cord under the TV set or other heavy items.
- Do not display a still picture for a long time, as this could damage the LCD screen.
- There is always power consumption if main plug is connected. Be aware that only way to disconnect mains power from your TV is to unplug mains plug from the wall, it shall remain readily operable during use of your product.
- **Servicing**—Do not attempt to service the product yourself. Removing covers can expose you to high voltage and other dangerous conditions. Request a qualified person to perform servicing.



do not place the product in an enclosed place such as a bookcase or rack, unless proper ventilation is provided or the manufacturer's instructions are followed.

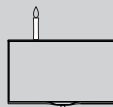

The LCD panel is a high technology product, giving you fine picture details.

Due to the very large number of pixels, occasionally a few non-active pixels may appear on the screen as a fixed point of blue, green or red. This is within product specifications and does not constitute a fault.

Precautions when transporting the TV

When transporting the TV, never carry it by holding onto the speakers. Be sure to always carry the TV by two people holding it with two hands—one hand on each side of the TV.

Cautions regarding use in high and low temperature environments

- When the TV is used in a low temperature space (e.g. room, office), the picture may leave trails or appear slightly delayed. This is not a malfunction, and the TV will recover when the temperature returns to normal.
 - Do not leave the TV in a hot or cold location. Also, do not leave the TV in a location exposed to direct sunlight or near a heater, as this may cause the cabinet to deform and the LCD panel to malfunction.
- Storage temperature: -20 °C to +60 °C.



Caution : DANGEROUS VOLTAGE INSIDE !

TO PREVENT ELECTRIC SHOCK, DO NOT REMOVE COVER. NO-USER SERVICEABLE PARTS INSIDE. REFER SERVICING TO QUALIFIED SERVICE PERSONAL.

Introduction

Remote control unit

- 1 **NET (Page 37)**
Access "AQUOS NET+" mode.
- 2 **Alphanumeric buttons 0-9**
Set the channel. Enter desired numbers. Set the page in teletext mode.
 - When the five Nordic countries (Sweden, Norway, Finland, Denmark or Iceland) are selected in the country setting from initial auto installation (Page 9), DTV services are four digits. When another country is selected, DTV services are three digits.
- 3 **⏮ (Flashback)**
Return to the previously selected channel or external input.
- 4 **I/F/L/E (Sound mode) (Page 17)**
Select a sound multiplex mode.
Picture format (Page 31)
Change between different picture formats.
- 5 **▲/▼/←/→ (Volume)**
Increase/decrease TV volume.
- 6 **⏸ (Mute)**
TV sound on/off.
- 7 **▲/▼/←/→ (Cursor)**
Select a desired item.
OK
Execute a command.
ATV/DTV/SAT: Display "CH list" when no other "MENU" screen is running.
⏮/⏪/⏩/⏭
Not used.
- 8 **MENU**
Main menu screen on.
Come back to last option selected within MENU screen.
- 9 **R/G/Y/B Colour buttons**
The coloured buttons are correspondingly used to select the coloured items on the screen (e.g., EPG, MHEG-5, teletext).
- 10 **☰ Teletext (Page 20)**
ATV: Display analogue teletext.
DTV/SAT: Select MHEG-5 or teletext for DTV/SAT.
- 11 **☺ Subtitle (Pages 17 and 20)**
Switch subtitle languages on/off.

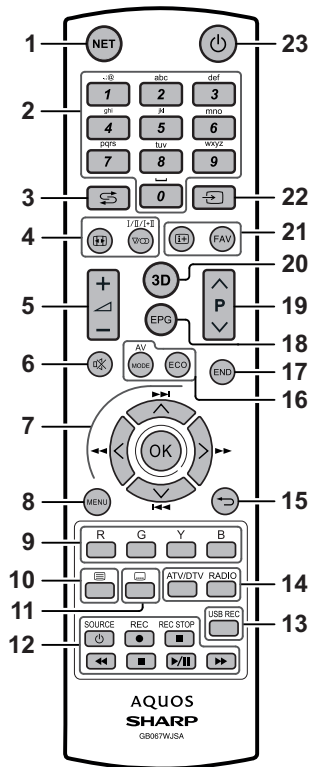

- 12 **⏮/⏪/⏩/⏭ (Pages 49 and 53)**
Video/Music/USB REC files reproduction buttons.
SOURCE (Page 44)
Operating HDMI-CEC device.
- 13 **USB REC (Page 49)**
Record a programme you are watching.

- 14 **ATV/DTV**
Access TV mode.
RADIO
DTV/SAT: Switch between radio and data mode.
 - When only data broadcasting (no radio broadcasting) is transmitted by DVB, the radio broadcasting will be skipped.
- 15 **⏮ Back**
ATV/DTV/SAT: Return to the previous "Menu" screen.
NET: Return to the previous page (This may not function for some services).
- 16 **Picture adjustment (Page 21)**
Select picture settings.
ECO (Page 21)
Activate/deactivate low consumption mode (ECO).
- 17 **END**
ATV/DTV/SAT: Exit the "Menu" screen.
- 18 **EPG (Page 18)**
DTV/SAT: Display the EPG screen.
- 19 **P▲/▼**
ATV/DTV/SAT: Select the TV channel.
NET: Scrolls pages up/down.
- 20 **3D (Page 54)**
Select between 3D and 2D image viewing.
- 21 **⏮ Channel information (Page 15)**
Display the station information (channel number, signal, etc.) on the screen.
Within MENU screen shows a hint about item selected.
FAV
Define active station as favourite.
- 22 **⏮ (AV selection) (Page 17)**
Select an input source.
- 23 **⏻ (Standby/On) (Page 17)**

Important information:
Satellite services are only available for the LE652/654 model series.

Introduction

TV (Front view)

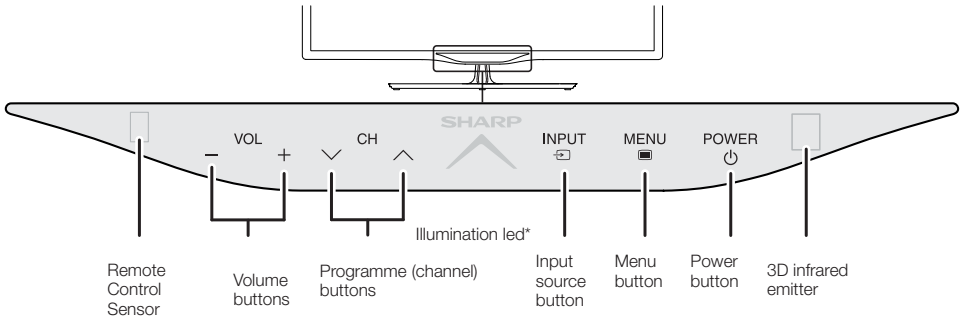

*TV indicator status (Page 17)

TV (Side and rear view)

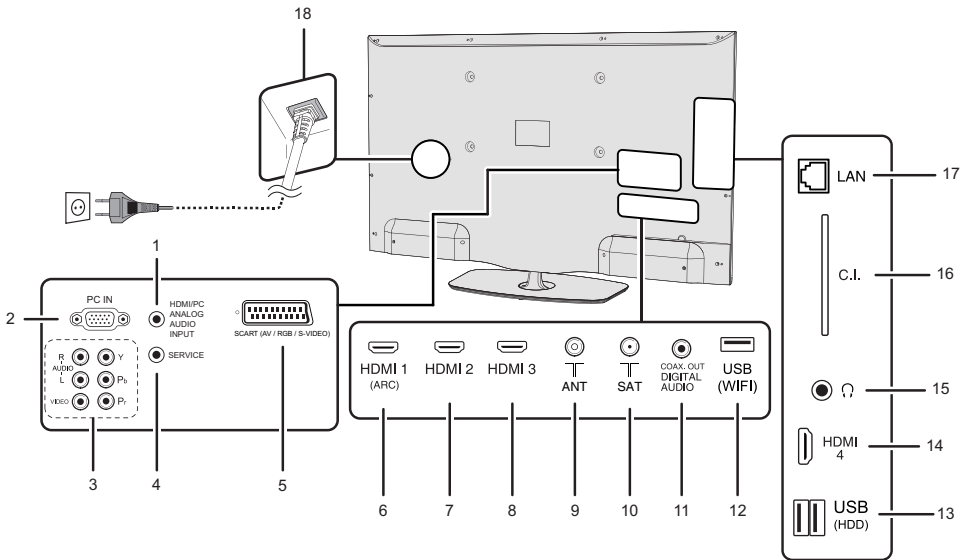

- 1 Analog AUDIO input for DVI and PC (Jack 3.5mm connector)
- 2 PC Input
- 3 COMPONENTS / AV terminals
- 4 SERVICE connector (jack 3.5 mm)
- 5 SCART (AV/RGB, Y/C Input) terminal
- 6 HDMI 1 (HDMI/DVI/ARC)
- 7 HDMI 2 (HDMI/DVI)
- 8 HDMI 3 (HDMI/DVI)

- 9 Antenna input terminal
- 10 SAT (Satellite antenna input) (Only L*652 series)
- 11 Digital Audio Output terminal (SPDIF)
- 12 USB terminal (Wi-Fi use only)
- 13 USB terminal (USB REC / MEDIA PLAYER / SOFTWARE / HDD READY / 3D GLASSES BATTERY)
- 14 HDMI 4 (HDMI/DVI)

- 15 HEADPHONES jack
- 16 COMMON INTERFACE slot
- 17 LAN terminal
- 18 AC INPUT terminal

WARNING

- Excessive sound pressure from earphones and headphones can cause hearing loss.
- Do not set the volume at a high level. Hearing experts advise against extended listening at high volume levels.

Preparation

Supplied accessories

Remote control unit
(x1)



• "AAA" size battery (x2)



• Cable tie (x1)



• Operation manual (This publication)

• Stand unit (x1)

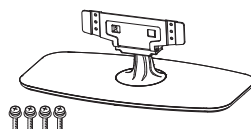

Attaching the stand unit

- Before attaching (or detaching) the stand, unplug the AC cord.
- Before performing work, spread cushioning over the surface on which you will be laying the TV. This will prevent it from being damaged.

CAUTION

- **Attach the stand in the correct direction.**
- **Be sure to follow the instructions. Incorrect installation of the stand may result in the TV falling over.**

Inserting the stand

- ① Insert the stand into the openings on the bottom of the TV (Hold the stand so it will not drop from the edge of the base area).
- ② Insert and tighten the four screws into the four holes on the rear of the TV.

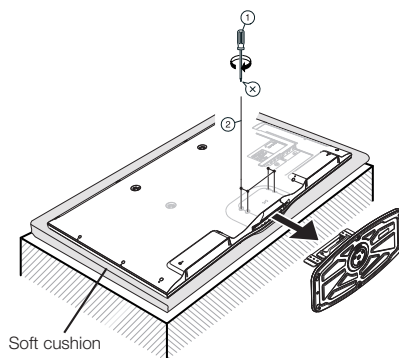

NOTE

- To detach the stand unit, perform the above steps in reverse order.

Optional accessory

The listed optional accessories are available for this LCD colour TV. Please purchase them at your nearest shop.

- Additional optional accessories may be available in the near future. When purchasing, please read the newest catalogue for compatibility and check the availability.

No.	Part name	Part number
1	Wall mount bracket	AN-S2AG4
2	Wi-Fi adapter	AN-WUD630
3	3D glasses	AN-3DG35
4	3D glasses	AN-3DG20-B

Fixing the TV on a wall

- **This TV should be fixed on a wall only with the wall fix bracket available from SHARP (above table). The use of other wall fix brackets may result in an unstable installation and may cause serious injuries.**
- **Fixing the LCD colour TV requires special skills and should only be performed by qualified service personnel. Customers should not attempt to do the work themselves. SHARP bears no responsibility for improper fixing or fixing that results in accident or injury.**
- You can ask qualified service personnel about using an optional bracket to fix the TV on a wall.
- To use this TV fixed on a wall, first remove the adhesive tape at the two locations on the rear of the TV, and then use the screws supplied with the wall fix bracket to secure the bracket to the rear of the TV.
- When you fix the TV on a wall, you should attach the supporting post.

Preparation

Inserting the batteries

Before using the TV for the first time, insert the two supplied “AAA” size batteries. When the batteries become depleted and the remote control unit fails to operate, replace the batteries with new “AAA” size batteries.

- 1 Open battery cover.
- 2 Insert two supplied “AAA” size batteries.
 - Place batteries with their terminals corresponding to the (+) and (-) indicators in the battery compartment.
- 3 Close the battery cover.

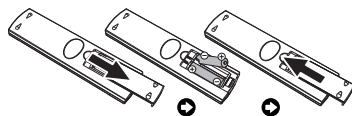

CAUTION

Improper use of batteries can result in chemical leakage or explosion. Be sure to follow the instructions below.

- Do not mix batteries of different types. Different types of batteries have different characteristics.
- Do not mix old and new batteries. Mixing old and new batteries can shorten the life of new batteries or cause chemical leakage in old batteries.
- Remove batteries as soon as they have worn out. Chemicals that leak from batteries can cause a rash. If you find any chemical leakage, wipe thoroughly with a cloth.
- The batteries supplied with this product may have a shorter life expectancy due to storage conditions.
- If you will not be using the remote control unit for an extended period of time, remove the batteries from it.
- When replacing the batteries, use zinc-carbon batteries instead of alkaline ones.

Note on disposing batteries:

The batteries provided contain no harmful materials such as cadmium, lead or mercury.

Regulations concerning used batteries stipulate that batteries may no longer be thrown out with the household rubbish. Deposit any used batteries free of charge into the designated collection containers set up at commercial businesses.

Using the remote control unit

Use the remote control unit by pointing it towards the remote control sensor. Objects between the remote control unit and sensor may prevent proper operation.

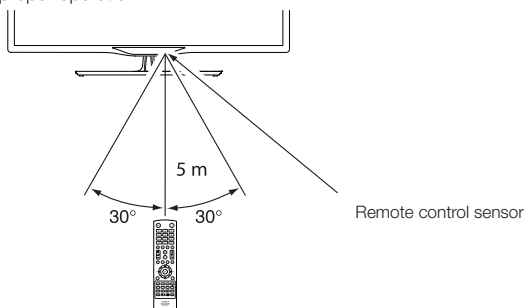

Cautions regarding the remote control unit

- Do not expose the remote control unit to shock. In addition, do not expose the remote control unit to liquids, and do not place in an area with high humidity.
- Do not install or place the remote control unit under direct sunlight. The heat may cause deformation of the unit.
- The remote control unit may not work properly if the remote control sensor of the TV is under direct sunlight or strong lighting. In such cases, change the angle of the lighting or the TV, or operate the remote control unit closer to the remote control sensor.

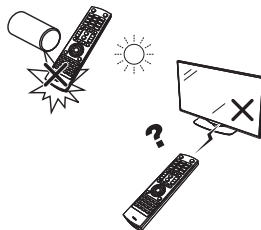

Quick guide

Initial installation overview

Follow the steps below one by one when using the TV for the first time. Some steps may not be necessary depending on your TV installation and connection.

1

Preparation

- 1 Connect an antenna cable to the antenna terminal (Page 8).

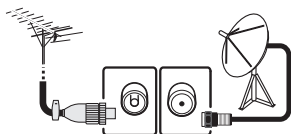

- 2 If necessary, insert a CA card into the CI slot to watch scrambled broadcasts (Page 8.)



- 3 Plug in the AC cord (Page 8).

Product shape varies in some countries.

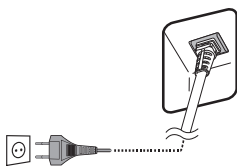

2

Power on and run the auto installation

- 1 Turn on the power using  on the TV (Page 17).

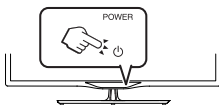

- 2 Run the initial auto installation (Page 9).

✓ Language, Energy Efficiency, country, antenna type settings, etc.

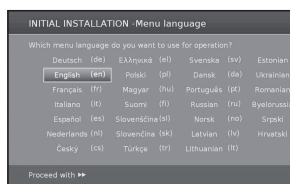

✓ Go to Next.



Start searching channels

3

Watch TV

- 1 **Congratulations! Now you can watch TV.**
- 2 If necessary, adjust the antenna to attain maximum signal reception (Page 14).

Connect external devices

- 1 Connect external devices such as a DVD player/recorder as instructed (Pages 41, 42 and 43).



- 2 Connect external audio devices such as speakers/amplifier as instructed (Pages 41, 42 and 43).

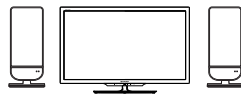

Quick guide

Before turning on the power

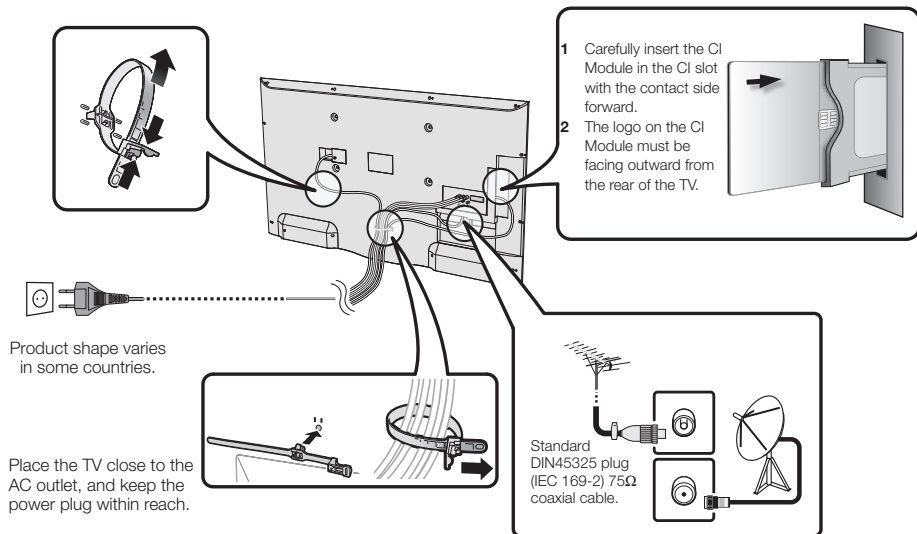

Inserting a CA Card

In order to receive coded digital stations, a Common Interface Module (CI Module) and a CA Card must be inserted in the CI slot of the TV. The CI Module and the CA Card are not supplied accessories. They are usually available from your dealers.

Inserting the CA Card into the CI Module

- 1 With the side with the gold coloured contact chip facing the side of the CI Module marked with the provider's logo, push the CA Card into the CI Module as far as it will go. Note the direction of the arrow printed on the CA Card.

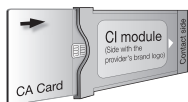

Inserting the CI Module in the CI slot

- 2 Carefully insert the CI Module in the CI slot with the contact side forward. The logo on the CI Module must be facing outward from the rear of the TV. Do not use excessive force. Make sure the module is not bent in the process.



Checking CI Module information

- 1 Press **MENU** and the "MENU" screen is shown.
- 2 Press **◀/▶** to select "Extras" menu.
- 3 Press **◀/▶** to select "CA module", and then press **OK**.

- The content of this menu depends on the provider of the CI Module.

● Module

General information on CI Module displays.

● Menu

Adjustment parameters of each CA Card displays.

● Enquiry

You can input numerical values such as passwords here.

NOTE

The content of each screen depends on the provider of the CI Module.

NOTE

- Make sure that the CI module is properly inserted.
- This menu is only available for digital stations.
- It takes about 30 seconds to certify the license key when you insert a CA card into the CI+ compatible CI module for the first time. This process may fail when there is no antenna input or you have never run "Auto installation".
- The CI+ compatible CI module sometimes upgrades its firmware. You may not receive any TV images before upgrading. You can only use the power button during upgrading.
- The CI+ compatible CI module does not allow you to output any copy protected programmes using monitor out.
- If the TV displays an update confirmation message for the CA card while receiving CI+ compatible broadcasts, follow the screen prompts.

Quick guide

Initial auto installation

When the TV is powered on for the first time after purchase, the initial auto installation wizard appears. Follow the menus and make the necessary settings one after another.

Confirm the following before turning on the power

- Is the antenna cable connected?
- Is the AC cord plugged in?

1 Press on the TV.

- The initial auto installation wizard appears.
- The auto installation can also be called in the TV menu, see **Repeat initial installation** on page 40.
- The routine of the first installation wizard depends on the selected settings.

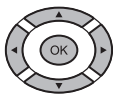
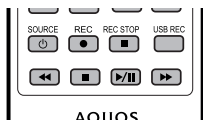

2 Setting the menu language.

Press // to select the desired language.

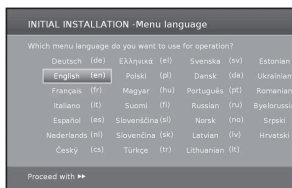

Proceed with  button.

3 Setting Energy Efficiency.

Decide how efficiently you want to operate your TV set.

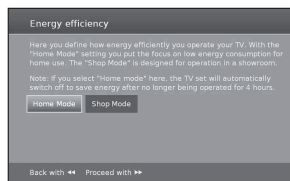

•Home Mode:

The emphasis for home use is on low energy consumption.

•Shop Mode:

The picture settings are aligned to operate in the presentation room. If the ambient brightness diminishes, the energy consumption is not reduced.

This setting can be changed later in the **MENU Extras**→**Energy Efficiency**.

Proceed with  button.

4 Selecting the TV location.

Press // to select your country or area.

- This setting screen only appears during the initial auto installation.

Proceed with  button.

5 Select broadcast settings.

Press / to move between different tune type.

Press **OK** to select the desired antenna.

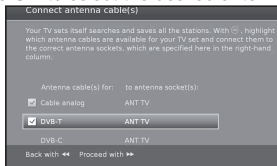

Cable analogue: analogue broadcast via cable/antenna.



DVB-T: Digital broadcast.

DVB-C: Cable digital broadcast.

DVB-S: Satellite broadcast. (Only 652/654 series)

Proceed with  button.

6 Select subtitles and audio languages.

Press // and **OK** to select the desired languages and alternative languages for subtitles and audio for DVB programmes.



Proceed with  button.

•To set up audio commentary for the visually impaired, please see **Audio commentary** on page 25.

Setting options for DVB-T reception

If you have not selected DVB-T antenna in the antenna selection, continue with **Setting options for DVB-C reception** on page 10.

7 Selecting tuner settings.

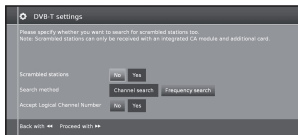

● Scrambled stations

You can specify if coded stations are to be searched for in the search/update.

Select **yes** to save all scrambled stations.

•These stations can only be received in connection with a CI module and the appropriate CA Card.

•If a CI module with a CA Card is already inserted for the station search, all the stations which this module can descramble are also saved when **no** is selected.

● Search method

Select **Frequency search** if you want to run the station search independently of the channel grid.

● Accept logical channel number

In various countries, digital stations are transmitted with a preset channel number per station, known as "Logical Channel Numbers" (LCN).

If you select **yes**, these default channel numbers will be used and the channels will be sorted as per LCN.

Quick guide

8 Supplying power to the antenna.

If you use a DVB-T antenna that requires a supply voltage and which is not supplied via a power adapter, then select **yes (5V)** for the antenna's power supply.

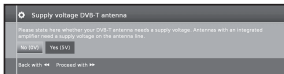

Press ►► button.

How to align your DVB-T antenna is described on page 14.

9 Continue with **Settings for all types of reception** (See page 13).

Setting options for DVB-C reception

If you have not selected DVB-C antenna in the antenna selection, continue with **Setting options for DVB-S reception** below.

The normal DVB-C settings are derived from the selection of the location and do not need to be changed.

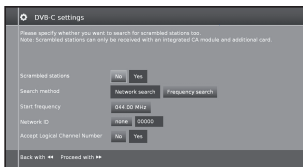

Press ▲/▼/◀/▶ to change each item to the appropriate settings:

● **Network selection**

If several networks are available via DVB-C, you can decide which network you want to receive your channels from.

● **Scrambled stations**

You can specify if coded stations are to be searched for in the search/update.

Select **yes** to save all scrambled stations.

- These stations can only be received in connection with a CI module and the appropriate CA Card.
- If a CI module with a CA Card is already inserted for the station search, all the stations which this module can descramble are also saved when **no** is selected.

● **Search method**

If you select **Frequency Search**, a search is performed for all receivable stations. With **Network Search**, only the stations which the networks supply are searched, either for all receivable networks or only for the particular network specified under **Network ID**.

● **Start Frequency**

The DVB stations are only searched for in the frequency range above the start frequency.

● **Network ID**

Change this setting to register only the specified network ID.

● **Accept logical channel number**

In various countries, digital stations are transmitted with a preset channel number per station, known as "Logical Channel Numbers" (LCN).

If you select **yes**, these default channel numbers will be used and the channels will be sorted as per LCN.

NOTE

- The value of **Frequency** and **Network ID** should be set to the value specified by the cable provider. Press ►► to continue.

Setting options for DVB-S reception

If you have not selected a DVB-S antenna in the antenna selection, continue with **Settings for all types of reception** on page 13.

Select the satellite system.

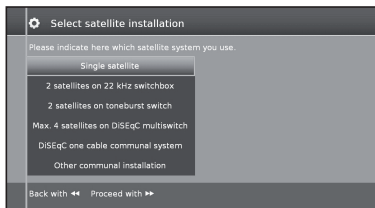

Specify how you receive which satellite(s) (single satellite or type of satellite system). Ask your dealer in this regard.

The normal DVB-S settings are derived from the selection of the location and do not need to be changed in most cases.

● **Single satellite**

Reception of a single satellite via a connected LNC (LNB). See page 11 for settings.

● **2 satellites on 22kHz switchbox**

Reception of two different satellites with two LNCs (LNBs) which are connected to the TV set by a 22 kHz switchbox. See page 11 for settings.

● **2 satellites on Toneburst switch**

Reception of two different satellites with two LNCs (LNBs) which are connected to the TV set by a toneburst switch. See page 11 for settings.

● **Max. 4 satellites on DiSEqC multiswitch**

The TV set controls a DiSEqC multiswitch to which up to four LNCs (LNBs) for different satellites are connected. See page 11 for settings.

● **DiSEqC one cable communal system**

Select setting if the TV set is connected to a DiSEqC single cable system (according to EN50494). Several satellite receivers can be connected to one satellite cable. See page 12 for settings.

● **Other communal installation**

Select this setting if the TV set is connected to a single-cable system (without DiSEqC). Several satellite receivers can be connected to one satellite cable. As opposed to a DiSEqC one cable system there are restrictions in the range of certain reception frequencies in common single-cable community systems. See page 13 for settings.

Press ►► to continue.

Quick guide

Setting options for Single satellite

Reception of a single satellite via a connected LNC (LNB).

1 Select satellite.

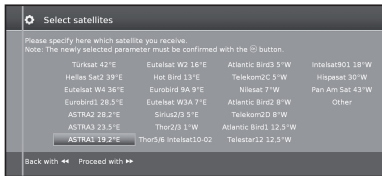

Press ►► to continue.

2 Select **Dual Band (low/high)** or **Single Band**. Here you specify if you use a Dual Band (Universal) LNB or Single LNB.

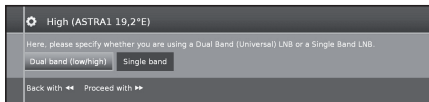

Press ►► to continue.

3 Specify here the oscillator frequency for your LNB.

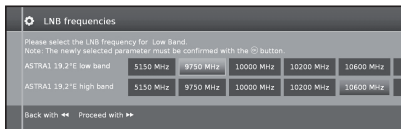

Normally you do not need to change the values for high and low band, unless the LNB of your satellite system uses a different oscillator frequency (important for the frequency display).

If you use the setting **Single Band** in step **Dual/Single Band**, you only have to define the LNB frequency for the Low Band.

4 Press ►► to continue.

See **Setting options for all DVB-S reception** on page 13 to continue.

Setting options for 2 satellites on 22kHz switchbox / 2 satellites on Toneburst switch

1 Select **Satellite1/Satellite2**



2 Select satellite name from list and press **OK**.

Press ►► to continue.



3 Specify here the oscillator frequency for your LNB.

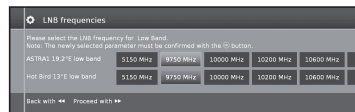

Normally you do not need to change the values for high and low band, unless the LNB of your satellite system uses a different oscillator frequency (important for the frequency display).

4 Press **OK** to select frequency and press ►► to continue.

See **Setting options for all DVB-S reception** on page 13 to continue.

Setting options for Max. 4 satellites on DiSEqC multiswitch

Select DiSEqC multiswitch and adapt settings for this selection.



Quick guide

• Repeat rate

The refresh rate determines how often a DiSEqC command is output. A refresh is only necessary with cascaded system.

• Control voltage

The control voltage controls the switch of the polarisation level (horizontal/vertical) in non-DiSEqC capable components (e.g., control of single LNBs via DiSEqC multiswitch).

• 22kHz signal

The 22kHz signal controls the switching between high and low band in the **Band** setting. The **Position** setting controls the selection of the satellites in non-DiSEqC capable components.

• Toneburst

The Toneburst controls the selection of the satellites in non-DiSEqC but Toneburst capable components with the **Position** and **Option** settings.

Press **OK** to adopt settings and press **▶▶** to continue.

1 Select **Satellite1** to **Satellite4**.



2 Select satellite name from list and press **OK**. Press **▶▶** to continue.



3 Specify here the oscillator frequency for your LNB.

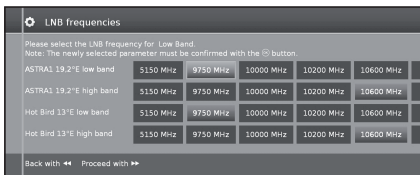

Normally you do not need to change the values for high and low band, unless the LNB of your satellite system uses a different oscillator frequency (important for the frequency display).

See **Setting options for all DVB-S reception** on page 13 to continue.

Setting options for DiSEqC one cable communal system

1 Select which DiSEqC single cable system you are using and press **OK**.

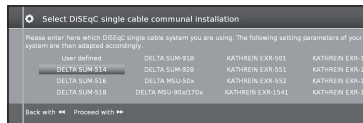

2 Select satellite name from list and press **OK**. Press **▶▶** to continue.



3 Specify here the oscillator frequency for your LNB and press **OK**. Press **▶▶** to continue.

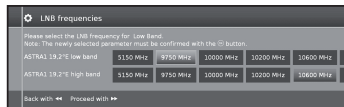

Normally you do not need to change the values for high and low band, unless the LNB of your satellite system uses a different oscillator frequency (important for the frequency display).

4 Select and adjust settings for DiSEqC single cable communal installation.

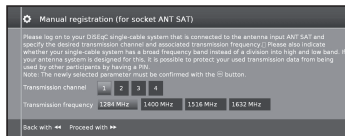

Select the desired transmission channel and the corresponding transmission frequency.

PIN protection

If your system is designed for it, it is possible to protect your used transmission data from use by other subscribers with a PIN.

Define/change PIN

Here you can determine and change the PIN for **PIN protection**. Only possible when **yes** has been selected for **PIN protection**.

Continue with **Setting options for all types of reception** on page 13.

Quick guide

Setting options for Other communal installation

1 Select satellite.



Press ►► to continue.

2 Specify here the oscillator frequency for your LNB.

If your set is connected to a single-cable system without external voltage supply, you can connect the antenna supply (13V or 18V / max. 450mA) with 13V or 18V.

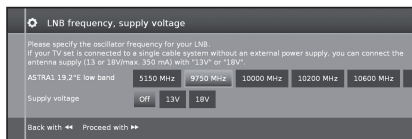

Continue with **Setting options for DVB-S reception** below.

Setting options for DVB-S reception

● Network selection

If several networks are available via DVB-S, you can decide which network you want to receive your channels from.

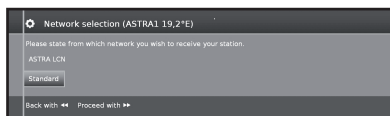

● Settings

If several satellites are received, the following settings must be made for every satellite. The type of settings available may differ depending on the selected satellite or network.

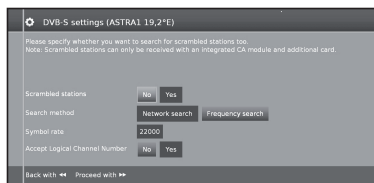

● Scrambled stations

Select **yes** to save all scrambled stations.

- These stations can only be received in connection with a CI module and the appropriate CA Card.
- If a CI module with a CA Card is already inserted for the station search, all the stations which this module can descramble are also saved when **no** is selected.

● Search method

If you select **Frequency Search** here, a search is performed for all receivable stations. With **Network Search**, from all receivable networks all the stations are searched which are supplied by these networks.

● Symbol rate

The symbol rate is specified by the satellite provider and normally does not need to be changed.

● Accept Logical Channel Number

This setting allows you to decide whether you want to accept the Logical Channel Number (LCN).

Press ►► to continue.

Continue with **Setting options for all types of reception** below.

Setting options for all types of reception

● Age related lock

Allows you to restrict programmes depending on the age classification.

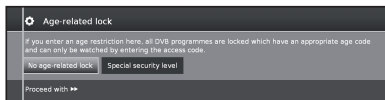

The information about age classification is provided by the broadcasting station.

The stations locked can only be watched after entering the access code (see page 24).

● Time and date

Enter the correct values with the numeric buttons here.

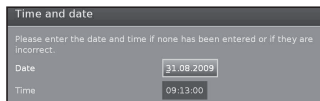

● Network configuration

Here you can now specify if you wish to configure a network **"Configure now"** (see page 47) or you wish to configure it later **"Do not configure or configure later"**.

Menu operation

What is the menu?

- The **MENU** view is the central overview page for all of your TV's operating modes.
- The list of options on the bottom of **MENU** view gives you access to TV, Video, Audio/Radio, Photo and AQUOS NET+.
- By means of **Extras** and **Setup** you have access to more functions and you can configure your TV set.
- On the top of the screen you will find all stations marked as favourites.
- The number of selectable items varies depending on the TV equipment, network connection, available media servers and connected devices.
- The **MENU** can be operated with the remote control unit and with the TV panel control keys.

Common operations

1 Display the menu screen

Press **MENU** and the "MENU" screen displays.



SHARP

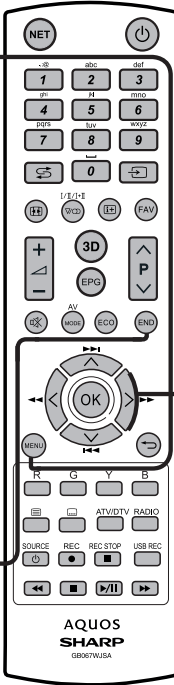

AQUOS
SHARP
GB067WJSA

2 Select an item

Press **▲/▼/◀/▶** to select/adjust the desired menu, and adjust the item to the desired level, and then press **OK**. Press **↶** to return to the previous **MENU** page.

- **Selecting in the menu**

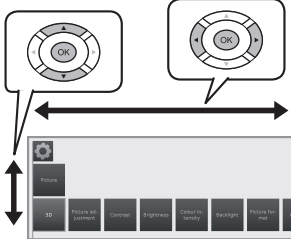

- **Selecting options**

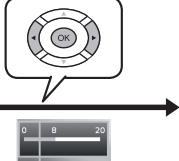

3 Exit the menu screen

The operation will exit the "MENU" screen if you press **END**.

NOTE

- **MENU** options differ in the selected input modes, but the operating procedures are the same.
- The screens in the operation manual are for explanation purposes (some are enlarged, others cropped) and may vary slightly from the actual screens.

About the Guide Display

The Guide Display at the bottom of the screen shows the menu bar.



In the initial installation you will see an info text for operations with the OSD.

Info display

The info display provides an info text appropriate to the on-screen display that can assist you further with the operation of your TV set.

Temporary info display (i+)

The factory setting is that the info display is hidden. It can be displayed temporarily by pressing **i+** key.

Menu operation

Permanently display or hide the automatic info display

The automatic info display can be hidden/shown via a menu setting.

- 1 Press **MENU** to call menu view.
- 2 With **▲/▼/◀/▶** select **Setup** and press **OK** to call settings.
- 3 With **◀/▶** select **Control** and press **OK**.
- 4 With **◀/▶** select **more** and press **OK**.
- 5 With **◀/▶** select **On-screen displays** and press **OK** to call settings.

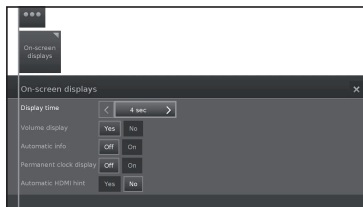

- 6 With **▲/▼** select **Automatic info** and select **Off/On** to hide/show the info display.
- 7 Press **OK** to adopt settings.

Operation with the TV panel control keys

This function is useful when there is no remote control unit within your reach.

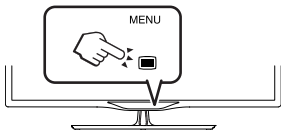

- 1 Press **MENU** to show/hide a menu for direct control on TV.
- 2 Press **CH▲/▼** to scroll left/right.
- 3 Press **↻ (INPUT)** to open a new menu level or accept the settings

NOTE

- The "MENU" screen will disappear if left unattended for several seconds.

Favourites

You will find your favourites on the top of the MENU screen.

You can create favourites in the operating modes of the TV set. In this way you get your preferred stations on a single overview page.

After an initial installation, TV stations will already be automatically created as favourites independent of the installation site of the TV set.

Creating favourites

You can define the current station as favourite by means of your remote control.

The favourite will be added to **MENU** view and placed at the end.

- 1 Press **FAV** to create a favourite.

If there are more favourites than can be shown on one page, this will be indicated by rectangular symbols below favourites in the **MENU** view.

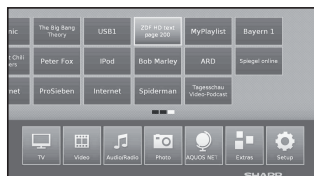

Manage favourites

You can edit the existing favourites in **MENU** view. Change the sequence of your favourites as you wish or delete favourites you do not need any more.

- 2 Press **MENU** to call MENU view.
- 3 With **▲/▼/◀/▶** select the favourite to be changed.
- 4 Press **FAV** to move or delete.

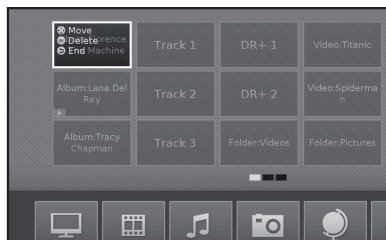

- 5 Press **↻** to end.

Watching TV

Daily operation

Switching on/off

Turning on/off the power

Press  on the TV to switch it on.
Switch it off by pressing  on the TV.

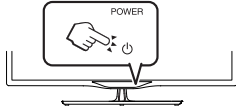

NOTE

- When turning off the power using  on the TV, EPG data will be lost.
- The terminal layout may differ depending on the model.

Standby mode

Switching to standby mode

If the TV is switched on (BLUE LED), you can switch it to standby by pressing  on the remote control unit.

Switching on from standby

From standby (RED LED), press  on the remote control unit.

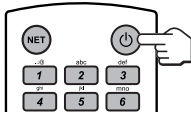

TV indicator status

LED indicator	Status
Off	Power off
Blue	Power on
Red	Standby
Violet	StandBy with USB REC programmed

NOTE

- If you are not going to use this TV for a long period of time, be sure to remove the AC cord from the AC outlet.
- A small amount of electric power is still consumed even when  is turned off.

Switching off the TV and connected additional devices

By long pressing on  the TV and all CEC capable devices connected to the HDMI interfaces switch to standby mode. See page 44 for more information.

Switching between digital, satellite and analogue broadcasts

- Press “**ATV/DTV**” or “**RADIO**” to change between modes.

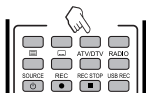

Changing channels



With P  :



With 0-9:



Selecting an external video source

Once the connection is made, press  to display the “**AV selection**” screen, and then press /  to switch over to the appropriate external source with **OK**.



Selecting audio language

DTV/CADTV/SAT mode:

Each time you press  the audio language switches between audio sources available.

NOTE

- Selectable languages vary depending on the received broadcasts.

ATV mode:

Each time you press  the mode switches as shown in the following tables.

NICAM TV broadcasts selection	
Signal	Selectable items
Stereo	NICAM STEREO, MONO
Bilingual	NICAM CH A, NICAM CH B, NICAM CH AB, MONO
Monaural	NICAM MONO, MONO
A2 TV broadcasts selection	
Signal	Selectable items
Stereo	STEREO, MONO
Bilingual	CH A, CH B, CH AB
Monaural	MONO

NOTE

- When no signal is received, the audio mode will display “MONO”.

Subtitles

DTV/CADTV/SAT mode:

Press  to enable/disable the subtitles.

To see how to change between different languages go to **Control settings** on page 24.

ATV mode:

The available subtitles according to the broadcasting will be enabled or disabled by pressing  button.

Watching TV

EPG

EPG is a programme list that is displayed on the screen. With the EPG, you can check the schedule of digital channels, view detailed information about it, tune to an event currently on-air and set a timer for future events.

The first time you press EPG, a wizard will start that guides you through the necessary presets.

You can find the EPG settings in the **MENU Setup→Control→more...→EPG**

EPG operation

● Display/Close the EPG screen

Press **EPG** button. Switch EPG on/off.

- The first time you press EPG, a wizard will start that guides you through the necessary presets. In the EPG wizard you decide for which station EPG data should be collected and displayed. We recommend to select only those stations which you receive regularly.
- You can find the EPG settings in the **Setup**.

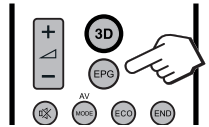

In the left column of the screen there is a list of stations of your currently active station list (personal list, overall station list). With the on-screen buttons in the header of the EPG you can select the day of the programme preview and filter the programmes as to their genre.

● Select a program

● Select the time span

-Press **◀▶** to select the time span you want to search, press **OK**.

- Continue to press **▶** to display programs in the next time span.

● Select the desired program

-Press **▲▼** to select the desired program, press **OK**.

- If **▲** or **▼** are displayed on the left of the programs, continue to press **▲▼** to display next or previous screen.

-Press **END** to exit out of **EPG**.

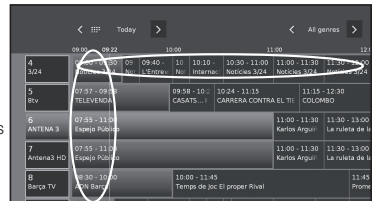

● Adapting the EPG overview

The options to be selected are in the header. If not, press **BLUE** key.

You can filter the programmes with genre selection in the header. The programme of the selected genre will be highlighted:

Movies	Arts
News	Social
Show	Education
Sports	Hobby
Child	Series
Music	

- Press **◀▶** to select day or genre.
- Press **OK** to confirm selection

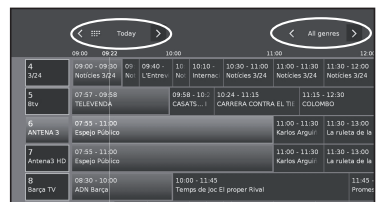

Watching TV

Other EPG functions

● Calling additional information about the programmes

- 1 Press ▲/▼/◀/▶ to select the programmes.
- 2 Press **f+**.

If there is more information on the selected programme, it will be indicated here.

Programme information

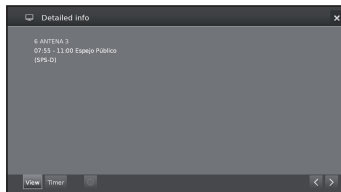

View: Watch selected programme.

The menu item is only available when the selected programme is on the air.

Memorise: Memorise the programme for later watching/listening.

This menu is only available when the selected programme has not yet started.

Delete memo: For programmes being memorised you can also delete the memo.

Timer: Call up the overview of the timer services.

● **(Recording):** Schedule the recording of the selected programme for a time.

- 3 Press ↵ to return to EPG.

● Memorising a programme via the EPG

For memorised programmes, the TV set will ask at the beginning of a programme if it should change the channel accordingly or switch on from the standby mode if this is activated in the **Setup**→**Control**→**more**→**EPG**→**TV on when memorised**.

- 1 Select the program which you want to memorise.
- 2 Press **f+**.
- 3 With ▲/▼/◀/▶ select **Memorise**, and press **OK**.
- 4 Press ↵ to return to EPG.

In the EPG a memorise symbol  is placed above the title of the programme.

● Timer programming

You can programme timer recordings of TV programmes.

- 1 Press ▲/▼/◀/▶ to select the programme.
- 2 Press **USB REC** button to programme timer recording for the TV programme. Timer data dialogue is opened.
- 3 Check the timer data and update it if necessary.

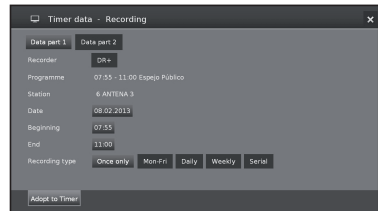

In the EPG a recording symbol ● is placed above the title of the programme.

Watching TV



Teletext

What is Teletext?

Standard teletext

Teletext broadcasts pages of information and entertainment to specially equipped TVs. Your TV receives teletext signals broadcast by a TV network, and decodes them into graphical format for viewing. News, weather and sports information, stock exchange prices and programme previews are among the many services available.

Turning Teletext on/off

- 1 Select a TV channel or external source providing a teletext programme.
- 2 Press  to display the Teletext.
 - Many stations use the TOP operating system, while some use FLOF (e.g. CNN). Your TV supports both these systems. The pages are divided into topic groups and topics. After switching on the teletext, up to 2,000 pages are stored for fast access.
 - Select  on the screen and press **OK**, the screen switches as shown below.
 - If you select a programme with no teletext signal, "No Teletext available" is displayed.
 - The same message is displayed during other modes if no teletext signal is available.

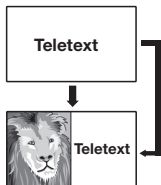







HbbTV Text

Pressing  twice will display the HbbTV-Text. HbbTV text is offered by the selected channel. Navigation within the HbbTV text and how the coloured buttons are assigned may vary depending on the provider.

NOTE

- Teletext will not work if the selected signal type is RGB.
- If HbbTV is offered by the channel, then the Media Text/ HbbTV text opens up. In this case, pressing  again opens the "standard" teletext/ videotext.

Buttons for standard teletext operations

Buttons	Description
	Increase or decrease the page number.
Colour (R/G/Y/B)	Page selection: Red: Back to the previously viewed page. Green: On to next page. Yellow: To next topic. Blue: To next range of topics. The coloured bars (for TOP) or the coloured text (for FLOF) in the second last line indicate which coloured buttons you can use to page through topic areas and topics.
0-9	Teletext page displays: 0: Stop updating teletext pages automatically or release the hold mode. 9: Enlarge page (press several times). Additional page selection: Directly select any page from 100 to 899 by using the numeric buttons.
	Mark desired page number. With OK call the page.
	Call overview page 100.
	Select it on the screen and press OK to update the teletext page.
	Show hidden information on the TXT page.
	Hide information on the TXT page again.
	Call Standard Teletext menu

Other teletext menu functions

Select  on the screen and press **OK**.

● Special pages

● Preview pages

Input of the first teletext programme preview page if this deviates from the factory setting.

● Sub-title pages

Input of the teletext subtitle pages for every station if this deviates from the factory setting.

● Character set

Teletext character set can be switched to other languages (Russian, Greek, Polish and Turkish).

Using the MHEG-5 application (UK only)

Some services bring you programmes with the MHEG application encoded, letting you experience DTV/ CADTV interactively.

When provided, the MHEG-5 application will start when you press .

NOTE

- MHEG may not be displayed in 3D mode.

Basic adjustment

TV set adjustments

Picture settings

- 1 Press **MENU**.
- 2 Select **Setup**→**Picture**, the next screen appears:

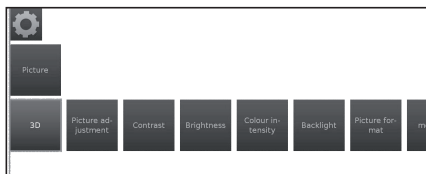

- 3 Select the picture adjustment you want to adjust:

● 3D

You can enjoy 3D-supported images on the TV when you wear 3D glasses (AN-3DG20-B or AN-3DG35), sold separately.

See more details on page 54.

● Picture adjustment

You can switch between three fixed picture setting variants and the three personal picture values:

Standard→ECO→Dynamic→User

● Contrast

The brighter the environment the higher the contrast should be set.

● Brightness

Set the brightness until the black areas of the picture appear just black.

● Colour intensity

Set the colour intensity to suit your personal taste. The colours should appear natural.

● Backlight

Adjusts the screen brightness. You can dim or brighten the screen.

● Picture format

Changes between different picture format:

16:9, 4:3, Panorama1, Panorama 2, Zoom

See page 31.

● more...



● Colour temperature

Adjusts the colour temperature to give the best white image:

Intensive → Normal → Soft

● Sharpness

Adjusts the picture sharpness to obtain the best definition.

● Move Picture up/down

With some picture formats the text or graphic displays at the bottom or on top are not (or only partially) visible. At this adjust you can move the picture up or down with cursor keys to make the displays visible.

● Active backlight

Automatic backlight adjustment according to the video content in order to improve the image contrast.

● Film quality improvement (DMM)

Reduces jolt in rapid picture object movements and rolling txt displays. It especially applies for movies. Choose among different options.

● Digital Noise Control (DNC)

With this adjustment you can eliminate or reduce picture noise.

Choose among different options.

● Skin tone

Adjusts the skin tones between purple and greenish.

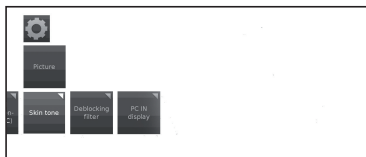

● Deblocking filter

To minimise the visible interference to the picture caused by modern compression methods this adjustment can be activated. It counteracts this interference.

● PC IN display

For some PC Image formats, horizontal as well as vertical position and the phase position of the image can be corrected. See page 45.

This menu appears only when a PC is connected via PC-IN terminal.

Sound settings

- 1 Press **MENU**.
- 2 Select **Setup**→**Sound**, the next screen appears:



- 3 Select the sound adjustment you want to adjust:

● Sound adjustment

You can adapt preset sound characteristics of the respective broadcast:

Off, Speech, Classical, Pop, Custom music sound and Custom film sound.

● Loudness

Proper boost of bass and treble tones at low volume.

● Surround sound

Allows you to enjoy surround sound.

Basic adjustment

● more...

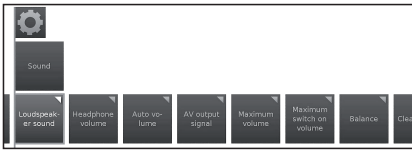

● Headphone volume

Adjust the headphone volume.

● Auto volume

Reduces volume differences (for advertisements that are too loud)

● AV output signal

Allows you to indicate which sound is output via the AV socket for dual sound programs: Sound1 (e.g. main language), sound 2 (e.g. foreign language) or sound 1+2 (both simultaneously).

NOTE

● Selectable items vary depending on the received broadcasts.

● Maximum volume

Determines the maximum volume that can be set.

● Maximum switch on volume

Allows you to specify the volume that the TV is set when switched on with the mains switch.

● Balance

Set stereo balance so that the volume impression is identical on the left and right.

● Clear Voice

If **Clear Voice** is activated, the sound of the current programme is automatically output with optimum comprehensibility when speech is detected.

● SPDIF mode

Allows you to choose between **PCM** or **Dolby Digital** audio output.

Stations settings

In this item you can find all settings concerned with station search for TV and DVB radio as well as functions for creating and editing the various stations list.

- 1 Press **MENU**.
- 2 Select **Setup**→**Stations**, the next screen appears:

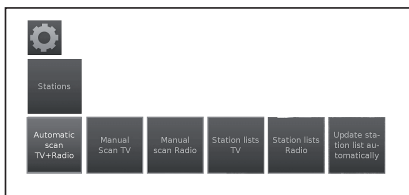

- 3 Select the station adjustment you want to adjust:

● Automatic scan TV+Radio

In this adjustment, with the search wizard, you can search/update new stations.

The current search settings will be displayed. If you want to change these search settings:

Select **Change search settings**, press **OK** and wizard will ask you for search settings.

If you agree with these settings, select **Start search/update** and press **OK** to start scan.

NOTE

● You have to repeat the initial installation (see page 9) and automatically search new ones, if you want to delete all existing stations.

● Manual Scan TV

If you want to adapt the parameters of an existing station, first select the appropriate station.

- 1 Select **Manual Scan TV** and press **OK**, the next screen appears:



- 2 Select the menu item **Signal source** to decide in which area you want to search for stations. Depending on the selected source, various setting possibilities will be available.
- 3 Select **Search** to start search for next station.
- 4 Select **Store** to save station.

NOTE

● Only stations for the selected signal source can be saved, which do not already exist in the station list.

Status bar for manual search

Status bars are displayed for manual search, which show the reception quality of the individual stations during the station scan. The markers in all bars should preferably be in the green area.



C/N: (Carrier/Noise) The bar shows the signal to noise ratio. The value indicated in dB should be preferably high.

Level: The bar shows the receiving level of the station. The value displayed in dBµV should be preferably high.

BER: (Bit Error Rate) The bar shows the bit error rate of the station. The value for BER should be as low as possible.

Basic adjustment

Explanations of some search settings

Signal source: Selection of range in which you want to search for the station.

TV stand: If necessary, ask your dealer which standard to select for specific channels or AV equipment.

Colour standard: If necessary, ask your dealer which standard to select for specific channels or AV equipment.

Channel: Direct entry of channel.

Frequency: DVB-T/C: Direct input of station frequency. Range for entry: 044.75 MHz - 859.25 MHz.

DVB-S: Direct input of LNC frequency.

Name: the name of the found station is displayed. You can change the name of the station.

Symbol rate: You can specify the symbol rate. DVB-S: Range: 1000-45000.

● Manual Scan Radio

The manual search for radio stations is similar to TV stations search. Please see **Manual Scan TV** explanation.

● Station lists TV

In this menu you can edit (delete block, move block) various lists. You can also create and edit new personal lists.

● Overall station list

You can delete and move station blocks.

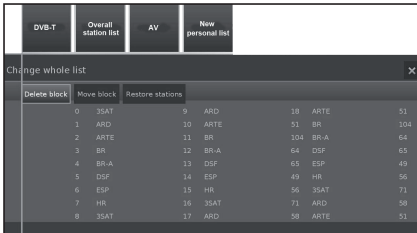

Delete block	Move block	Restore stations
0 3SAT	9 ARD	18 ARTE 51
1 ARD	10 ARTE	51 BR 104
2 ARTE	11 BR	104 BR-A 64
3 BR	12 BR-A	64 DFP 65
4 BR-A	13 DFP	65 ESP 69
5 DFP	14 ESP	49 HR 56
6 ESP	15 HR	56 3SAT 71
7 HR	16 3SAT	71 ARD 58
8 3SAT	17 ARD	58 ARTE 51

-Delete Block

- 1 With **▲/▼/◀/▶** select the beginning of block. Press **OK** to mark.
- 2 With **▲/▼/◀/▶** select the end of block. Press **OK** to mark.
- 3 Select **Execute delete** and press **OK** to delete block. (Select **Cancel process** to cancel delete).

-Move block

- 1 With **▲/▼/◀/▶** select the beginning of block. Press **OK** to mark.
- 2 With **▲/▼/◀/▶** select the end of block. Press **OK** to mark.
- 3 With **▲/▼/◀/▶** select insert position. Press **OK** to confirm insert position.
- 4 With **▲/▼/◀/▶** select **Execute move** and press **OK** to move block. (Select **Cancel process** to cancel move).

-Restore stations

- 1 With **▲/▼/◀/▶** select the beginning of block. Press **OK** to mark.
- 2 With **▲/▼/◀/▶** select the end of block. Press **OK** to mark.
- 3 With **▲/▼/◀/▶** select **Restore stations** and press **OK** to restore block. (Select **Cancel process** to cancel restore).

● DVB-T

Shows available stations to move, delete and rename stations in the (all) list:

-Add/remove stations

-Move stations

-Delete list

-Rename list

● New personal list

It is possible to compose personal lists to suit your convenience. It is possible to create up to six personal lists.

-Adding stations to Personal list

- 1 Select **New personal list** and press **OK**. A new personal list (x) will be created.
 - x number depends on how many lists were already created.
- 2 With **◀/▶** select **Personal list x** and press **OK** to open (list does not contain any station yet).
- 3 Press **▼** to open function list.
- 4 With **◀/▶** select **Add/Delete Stations** in the function list and press **OK** to activate.
- 5 With **▲/▼/◀/▶** select the stations you want to add to the favourite list and press **OK**.

The new stations will be added at the end of the favourite list.

- 6 Press **END** to close station list.

-Deleting stations from Personal list

- 1 With **◀/▶** select **Personal list x** and press **OK** to open.
- 2 With **◀/▶** select **Add/Delete Stations** in the function list and press **OK** to activate.
- 3 With **▲/▼/◀/▶** select the station to be deleted and press **OK** to delete.
- 4 Press **END** to close station list.

-Move/reorder stations in Personal list

- 1 With **◀/▶** select **Personal list x** and press **OK** to open.
- 2 With **◀/▶** select **Move stations** in the function list and press **OK** to activate.
- 3 With **▲/▼/◀/▶** select the station to be moved and press **OK** to mark.
- 4 With **▲/▼/◀/▶** select insert position and press **OK** to move.
- 5 Press **END** to close station list.

Basic adjustment

-Renaming Personal list

- 1 With ◀/▶ select the personal list you want to rename and press **OK** to open.
- 2 With ◀/▶ select **Rename list** in the function list and press **OK** to activate.
- 3 Enter new name using an on-screen keyboard or remote control (as with keypad of a mobile phone).
- 4 Press **OK** to confirm new name.

-Delete Personal list

- 1 With ◀/▶ select the personal list you want to delete and press **OK** to open.
- 2 With ▲/▼/◀/▶ select **Delete list** and press **OK** to confirm.

List deletion is irrevocable.

● Station lists Radio

The **Stations list Radio** procedure is the same as that of **Stations list TV**. Please see **Station List TV** explanation.

● Update station list automatically

The channel list will be updated automatically if **Allow** is selected.

Control settings

- 1 Press **MENU**.
- 2 Select **Setup**→**Control**, the next screen appears:

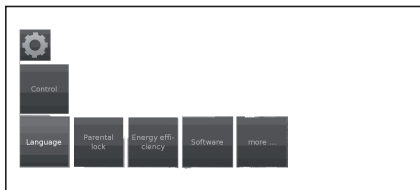

- 3 Select the control adjustment you want to adjust:

● Language

Allows you to specify the language for all menus in the TV set. Also the language can be set for DVB subtitles and the film language.

● Menu

You can change the menu language.

● Subtitle (DVB)

If subtitles are provided by DVB station, you can set here your desired language. If it is available in the station, it will be shown automatically.

You can also specify an alternative language in case your chosen language is not offered by the station.

● Audio (DVB)

Select your desired film language. If it is available in the station, it will be shown automatically.

You can also specify an alternative language in case your chosen language is not offered by the station.

● Parental lock

This function allows you to use a password to lock certain programmes and adjustments.



- 1 Define a four digit access code (PIN) the first time you open it.
- 2 Select **Confirm** and press **OK** to activate.
- 3 The new PIN must be entered and confirmed again.

The **Parental lock** menu will be opened:

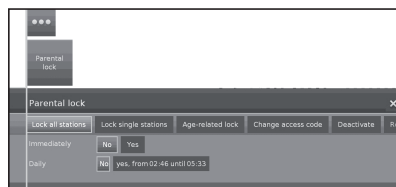

● Lock all stations

The TV set is locked immediately. All programmes can only be watched after entering the access code. The lock can be activated **Immediately** or for a **Daily** defined period.

The lock remains active until it is deactivated.

● Lock single stations

You can lock/unlock individual or all the stations in the station list.

The lock remains active until it is deactivated.

● Age-related lock

Some broadcasting stations provide information about age classification. If the age set here is below the broadcast age limit, the programme can only be watched after entering the access code.

● Change access code

You can change the access code at any moment. Enter the new access code in place of the old one.

● Deactivate

All set parental locks are cancelled. The current secret code is deleted. When the parental lock is reactivated, all the previous parental locks are set again automatically.

● Reset

All currently set parental locks are finally cancelled. The secret code is deleted.

● Energy efficiency

Determine how energy efficient your TV set shall be by choosing between: Home Mode → Shop Mode. See pages 9 and 21.

● Software

This option allows you to have the TV software version always updated. You can download new software from different sources:

Basic adjustment

● Software update

● Via USB

Current software version can be downloaded from the SHARP Internet site and installed on your TV using a USB memory.

● Via Internet

The software update wizard appears.

See page 27 for more information.

● Via antenna

The software update wizard appear.

NOTE

- The file system of USB memory must be FAT32.
- The USB memory must have only one partition.
- If in doubt, the USB memory should be formatted as "FAT32" without "extended attributes".
- A broadband connection and Network setup are required to update the software using the internet.

● more...



● On-screen displays

You can select different settings which affect the on-screen displays.

● Display time

You can adjust the duration of the display.

● Volume display

You can set whether or not the change in the volume should be displayed visually on the screen.

● Automatic info

Here you can activate/deactivate the additional help in the screen while navigating the menu.

● Permanent clock display

The time can be displayed permanently. It is always visible as long as no other display is activated.

● Automatic HDMI-CEC hint

If this option is activated, a message about the adapted function of the remote control is shown whenever you switch over to an HDMI port position to which a **HDMI-CEC** compliant device is connected.

● Time and date

Allows you to enter the time and date manually.

● Time

Enter the time with the numeric buttons of the remote control.

● Deviation from Universal Time

The current time at the Greenwich Meridian 0° is to be understood as world time. The time shift in relation to this time must be given in hours (with the ◀/▶ in the TV and **OK** button of the remote control).

● Date

Enter the date with the numeric buttons of the remote control.

● Summer/winter

Set it to **yes** if you want to activate automatically summer time.

● Beginning of daylight-saving time

Enter the date on which the time is switched over to summer time if it deviates from the automatically calculated date.

● End of daylight-saving time

Enter the date on which the summer time ends if it deviates from the automatically calculated date.

● DVB settings

You can make general presets for DVB stations.

● Subtitle mode

You can preset whether a subtitle is always to be displayed as soon as it is offered by the station. A special subtitle for impaired hearing can also be selected.

NOTE

- Subtitles are not offered by all stations. Many stations only broadcast subtitles by teletext.

● DVB character set

Select the DVB character set so that the title of the broadcast of your favourite received station or the texts of your CI module are displayed correctly.

● Audio commentary

You can activate a special sound for viewer with impaired vision.

● EPG

EPG is a programme list that is displayed on the screen. With the EPG, you can check the schedule of digital channels, view detailed information about it, tune to an event currently on-air and set a timer for future events. Also recordings can be programmed.

● Station selection

Here you can determine for which station in the programme guide information is to be displayed.

● Data capture

Here you can switch the data entry for the electronic program guide (EPG) **on** or **off**.

If the data capture is switched on, your TV set tries to update the data base overnight or, if required, two minutes after switching to stand-by mode. The TV set must be on stand-by for this and not switched off at the mains switch.

The indicator on the TV set lights violet during data capture in stand-by mode.

The data is also updated while you are watching the EPG station.

● TV on when memorised

When **yes** is selected, the switched off TV switches on automatically in standby mode at the beginning of a memorised programme. A screen message appears when switching on. If this is not confirmed within 5 minutes with the **OK** button, the TV switches off again automatically for safety reasons.

● USB REC

Is possible to adjust the USB REC to your requirements.

● Notify hidden sections

If an entry has been hidden in an archive recording (see page 52) you can be informed by a screen message when skipping a hidden area, by selecting **yes**.

Basic adjustment

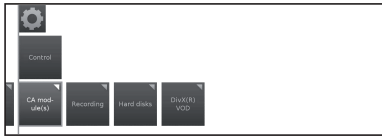

● Recording

It is possible to set a pre-record and post-record time for timer recordings made without auto time control (DVB).

This minimises the risk that a part of broadcast is not recorded due to the broadcast starting earlier and/or finishing later.



● Hard disks

● Format external one

It is possible to re-format the hard disk in order to solve some problems or to delete all data stored on it. Select this option to start formatting.

Formatting the hard disk will erase all data stored on it.

● DivX® VOD

● DivX® VOD Register

To activated this option you need to register the code at www.divx.com/vod, download the VOD log file and reproduce it in TV.

● DivX® VOD Deregister

Displays the deactivation code necessary to wite off this TV at www.divx.com/vod.

Software update via USB

It is possible to update the software on your SHARP TV.

- 1 Add the binary file to USB memory root.
- 2 Insert the memory in any USB side TV set socket.
- 3 Press **MENU** button.
- 4 With **◀/▶** select **Setup** and press **OK**.
- 5 Select **Control** → **Software** → **Software Update** → **Via USB**.

The next screen will appear:

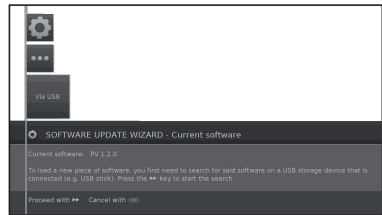

The software version that is currently installed is displayed.

6 Press **▶▶** button to proceed. The TV searches for a new software file on the USB stick.

If a new software version is available after the search, a message appears:

New software Vx.xx

7 Press **▶▶** button to start loading the new software.

Or press **END** to end the wizard (the software will not be updated).

- The updated percentage appears.

8 To make your TV completely ready for use again, please switch it off and on with the mains switch.

Software update via Internet

If an Internet connection is available, new software can be downloaded directly and installed in the TV set.

1 Press **MENU** button.

2 With **◀/▶** select **Setup** and press **OK**.

3 Select **Control** → **Software** → **Software Update** → **Via Internet**.

A message regarding data protection will be displayed.

4 If you do not agree with data protection message, please press **◀◀** to exit. If you agree, please press **▶▶** to continue.

The version of the software that is currently installed will be displayed.

5 By pressing **▶▶** the TV connects to the Internet and scans the update server for new software.

If a new software version is available, a message appears.

6 Press **▶▶** to start loading the new software.

If you want to end the wizard, please press **END**.

7 To make your TV completely ready for use again, please switch it off and on with the mains switch.

NOTES

- Please do not switch off the TV by the mains switch during software updating.
- The total programming process can take up to 50 minutes in total.

Basic adjustment

Multimedia / Network settings

- 1 Press **MENU**.
- 2 Select **Setup**→**Multimedia/Network**, the next screen appears:

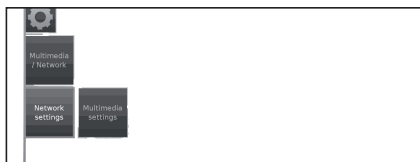

- 3 Select the option you want to adjust:

● Network settings

With this option you can make settings to your network adapters and the various types of media.

● Networking

The network wizard starts that guides you through all necessary settings to your network.

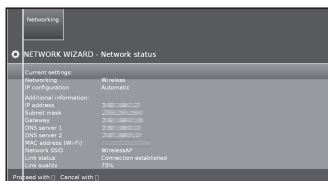

See page 47 for more information.

● Reset to factory settings

All network settings are reset to factory defaults.

● Host name

Give your TV set a name so that it can be identified in the network.

● Proxy server

Do the settings for using a proxy server. The proxy server wizard will be shown.

See page 47 for more information.

● Multimedia settings

Here you find some settings for Audio.

● Auto return to music player

The music player will reappear whenever another dialogue, e.g., music selection is called during playback, and no keys are pressed for the set time period. You can specify when and after which time the music player reappears (selection options are: no, after 1 min, after 5 min).

Connections settings

- 1 Press **MENU**.
- 2 Select **Setup**→**Connections**, the next screen appears:



- 3 Select the connection you want to adjust:

● Antenna DVB

Allows you to make settings for DVB-T antenna and call the antenna wizard for the DVB-S antenna.

● Antenna DVB-S

The antenna wizard starts guiding you through all the settings relevant to the DVB-S antenna. The settings of the DVB-S antenna wizard are explained in the procedure of initial installation (see page 10).

● Antenna DVB-T

Allows you to set whether your DVB-T antenna needs a supply voltage.

Antennas with an integrated amplifier need a supply voltage on the antenna line. In this case select **Supply voltage 5V** and confirm with **OK**.

Otherwise, select **No supply voltage** and confirm also with **OK**.

● AV connecting settings

In this menu the parameters for the AV and AVS connection sockets can be adapted.

● Device at connection AV

Indicate here whether a device is connected and, if so, which one is connected to the AV socket.



Choose between: No device, DVD player, DVD recorder, Video recorder, Sat receiver, SetTopBox and Other equipment.

Basic adjustment

- **AV standard**

Allows you to set the AV standard of the connected device to AV or AVS.

Normally you leave the setting to **Automatic**. If the standard of the connected device is not detected automatically, you can select the correct standard.

NOTE

- Ask your dealer or consult the operating manual of the connected device if necessary.

- **Signal type**

Allows you to set the signal type of the device connected to AV or AVS.

- **Allow switching voltage**

If this function is activated, the video and audio of an external device connected to the AV connector (not in AVS) will be automatically reproduced on all TV broadcast sites when reproduction is started up, provided that the external unit supplies a switching voltage.

- **HDMI-CEC**

Here you can make further settings for comfortably linking external devices to the TV sets.

- **Remote TV switch on via HDMI-CEC**

Here you can select whether the TV set is to switch on automatically from standby mode, if **HDMI-CEC** capable devices connected to a HDMI input start playback or display a screen menu.

- **HDMI-CEC functionality**

You can allow or forbid the automatic communication between the TV set and linked external devices.

Channel list

Selecting the channel you want to watch

- 1 Press **OK** and the list of tuned channels will be displayed.
- 2 Use **◀▶** to select the channel you want to watch and press **OK**.



You can watch overall station list or a personal list of channels by pressing **▲**.

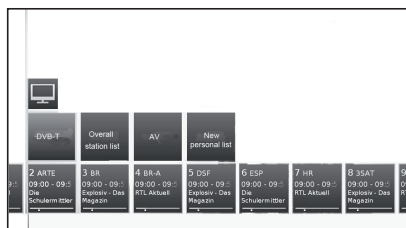

Channel information display (DVB-T / DVB-C only)

You can display the channel information that you are watching at this moment by pressing **(+)** on the remote control unit.



In the left lower corner you can see the number and name of the channel, the transmission time and (if available) the title of the current programme. The bar (if available) indicates the progress of the current programme.

In the right lower corner, the programme info is displayed additionally for DVB channels.

Basic adjustment

Symbol explanations in the channel info

General symbols:



Language/sound selection available



Subtitles available



Channel selection for multi-channel providers



3D mode



HDTV programme



HbbTV mode available from this station

Transmitted audio signal:

Mono	Mono audio transmission analogue
Dual channel	Dual channel sound transmission (Sound1 /Sound2) analogue
1+1	Dual channel sound transmission (Sound1 /Sound2) digital
Stereo	Stereo sound transmission analogue
Stereo (AAC+)	Stereo sound transmission (HEAAC)
	Stereo sound transmission digital (PCM)
Digital	Dolby digital sound transmission (DD)
Digital+	Dolby digital sound transmission (DD+)
Digital (AAC+)	Dolby digital AAC+ sound transmission (HEAAC)
MPEG	MPEG sound transmission

Transmitted audio channels:

	DD	mono
	DD	MPEG 2.0
	DD	
	DD	
	DD	
	DD	
	DD	
	DD	
	DD	
	DD	

Useful viewing functions

Selecting the picture format

Selecting the picture format manually

You can select the picture format. The selected picture format varies depending on the type of signal received.

- 1 Press **(F4)** on the remote control unit to change between different kinds of pictures.

Sizes for SD Signal (Standard Definition)

16:9: Proportionally correct display of 16:9 broadcasts.

4:3: Proportionally correct display of 4:3 broadcasts.

Panorama 1: Proportionally correct display of 4:3 broadcasts on the 16:9 screen. Station logo and subtitles remain visible.

Panorama 2: Format filling display (factory default) of 4:3 broadcasts on the 16:9 screen. Station logo and subtitles remain visible.

Zoom: Proportionally correct display. Maximum picture zoom. Displayed text may get lost.

Sizes for HD Signal (High Definition) HDMI

4:3 TV: Proportionally correct display of 4:3 or 16:9 broadcasts. You select this mode when the signal is not supplied by a PC (normal case). A small part of the picture is truncated. This may be necessary to hide possible interference at the edge of the picture, which arises from the signal supplied.

16:9 TV: Proportionally correct display of 4:3 or 16:9 broadcasts without loss of information. Select this mode when the signal is supplied by a PC.

4:3 PC: Proportionally correct display of 4:3 or 16:9 broadcasts without loss of information. Select this mode when the signal is supplied by a PC.

16:9 PC: Proportionally correct display. Maximum picture zoom. Displayed text may get lost.

NOTE

- Some items do not appear depending on the type of received signal.

Setting when using external devices

Source list

For selecting the input type of external equipment.

- If no (colour) image is displayed, try changing to another signal type.
- Check the operations manual of the external equipment for the signal type.

Connecting a USB device

Connect a USB or hard disk device to the TV as shown below.

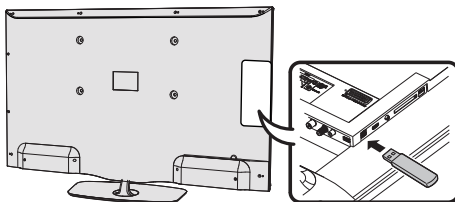

- Depending on the USB device, the TV may not be able to recognise the contained data.
- Use only alphanumeric characters for naming files.
- File names over 80 characters (may vary depending on character set) may not be displayed.
- Do not disconnect a USB device or memory card from the TV while transferring files, using the slide show function, when a screen is switching to another or before you exit Video, Music or Photo menus.
- Do not connect and disconnect a USB device from the TV repeatedly.

TV menu options



TV/List function

This function contains settings and additional options. The function list can be opened directly in TV mode or via the station list.

Via station list:

- 1 Press **OK** on R/C.
- 2 Select station and press **OK**.
- 3 Press **▲**. The next screen appears:

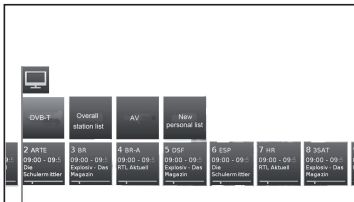

- 4 Select the station you want to adjust through **Overall station list** or **Personal list** and press **▼**.

In TV mode:

- 1 Press **MENU** on R/C.
- 2 Select **TV** and press **OK**.
- 3 Select the station you want to adjust and press **▼**. The next screen appears:



- 4 Select the adjustment you want to adjust.

Expanded station list

Open expanded station list.

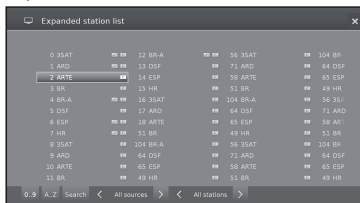

Using the on-screen buttons on the bottom line of the expanded station list it is possible to filter and sort the station list by various combinations of options.

- **0..9**
Allows you to sort stations numerically.
- **A..Z**
Allows you to sort stations alphabetically.

Search

This allows you to do targeted searches for stations. The station name is to be entered via the on-screen keyboard.

All sources

You can specify whether the stations from all sources or only from individual sources/reception networks (DVB-C, DVB-S, DVB-T, analogue) shall be indicated.

All stations

You can specify if all stations, only HD stations, locked stations, scrambled stations, unscrambled stations, CI+ protected stations, newly found stations or stations that cannot be found from selected sources shall be indicated.

Language/sound

Language/ sound selection.

The sound formats on offer and their designations depend on the programme being broadcast.

Subtitles

Subtitle selection.

The subtitles available depend on the programme being broadcast.

Channel/Video

This option only appears if there are more than one video components available.

Recording

You can programme timer recordings on the TV set for USB Recording, or for recorders that are otherwise connected. The recording wizard is integrated for programming a recording.

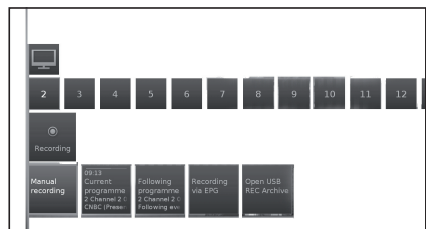

Manual recording:

Programme the recording manually.

Current programme:

Record currently watched programme.

Menu item will only be indicated when EPG data is available for the current station.

Following programme:

Record following programme.

Menu item will only be indicated when EPG data is available for the current station.

Recording via EPG:

Programme recording of a programme via the electronic programme guide (EPG).

TV menu options

- **Open USB REC archive**

Opens the USB REC archive. See USB REC explanation.

See page 49 for more information.

- **Sound Settings**

See **Sound** adjustments on page 21.

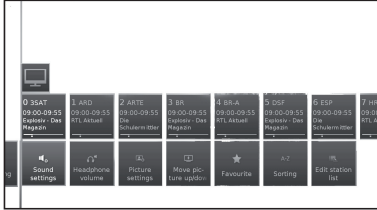

- **Headphone volume**

Adjust the headphone volume for current station.

- **Picture settings**

See **Picture** adjustments on page 21.

- **Move picture up/down**

With some picture formats the text or graphic displays at the bottom or on top are not (or only partially) visible. At this adjust you can move the picture up or down with cursor keys to make the displays visible.

- **Favourite**

Press **OK** on R/C to add current station as favourite to **MENU** view.

- **Sorting**

Allows you to sort stations numerically or alphabetically.

- **Edit station list**

In this menu you can edit (delete block, move block) various list. For more information see **Stations list TV** on page 23.

Detailed information

When you are watching TV, pressing **ⓘ** button twice, the next screen will appear:

- **Detailed info**

Shows detailed info of current station.

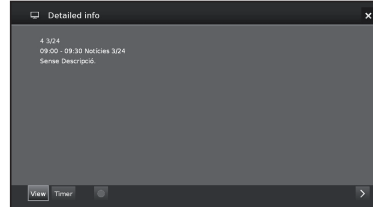

If there is more information on the selected programme, it will be indicated here. You find further information on the indicated programme in the bottom line.

- **View**

Watch selected TV programme/ listen to selected radio programme.

The menu item is only available when the selected programme is on the air.

- **Memorise**

Memorise the programme for later watching/ listening.

This menu is only available when the selected programme has not yet started.

- **Delete memo**

For programmes being memorised you can delete the memo.

This menu is only available when there are programmes memorised.

- **Timer**

Shows the overview of Timer Services (See page 50).

- **(Recording)**

Schedule the recording of the selected programme for a time.

TV menu options

This TV allows you to playback multimedia contents (photos, music files, videos) that are saved on a USB stick and on your home network and are made available via a media server. You may also access the internet and reproduce photos, music and video files. You can connect your TV to your home network via wired Ethernet or by a Wireless connection. See page 47 for TV Network setup.

Video function

Press **MENU** button on the R/C and select **Video**, to access the video files.



Video mode

Reproduces films and videos.

- 1 Select **Video** menu and press **OK**.
- 2 Pressing **◀/▶** buttons you can change between different reproduction sources: **USB REC archive**, or **USB/DLNA**.
USB REC archive: recordings made with USB REC.
USB/DLNA: files from USB or your home network. Press **OK** to select the device from which you want to reproduce the files.
- 3 Select the file you want to reproduce with **◀/▶** buttons and press **OK** to start the reproduction.



- 4 Press **■** to finish the reproduction.
- 5 Press **END** to exit the **Video** mode.

Buttons for video reproduction mode

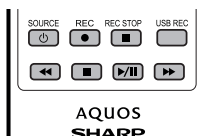

Buttons	Description
◀▶ (short)	Jump backwards/forward.
■ button	When playing videos from Media Home: Stop playback and return to the media browser. From time-shifted television: time offset finish and switch back to the live image. In archive playback: Stop playback and return to the USB archive.
▶ button	Play the reproduction.
◀◀	Backwards. Pressing again changes the speed.
▶▶	Fast forwards. Pressing again changes the speed.
button	Play / Pause the reproduction.
MENU button	Shows the menu to adjust the video image during reproduction.
⊕ button	Performs ZOOM operation in films and videos.

Symbols on the screen for video reproduction

Symbols	Description
	Repetition (continuous playback) all video files of the current folder/directory.
	Continuous playback of the current file.
	Shows information about current playback.
	Call function list video settings.
	Change video playback formats.
hh:mm	Skip to desired position in the reproduction.

Symbols on the screen for USB REC archive reproduction

Symbols	Description
	Activate/deactivate current playback file repetition.
	Set/delete manual bookmarks.
	Jump to next/previous bookmark.
	Shows information about current playback
	Call function list video settings.
	Call video edit menu.

TV menu options



Audio/Radio function

Music files from your local servers and USB storage media as well as DVB and Internet radio, can be found in the section Audio/Radio. The individual sub-items are described below.



DVB/Online radio

The TV set can receive digital radio stations via DVB.

USB/DLNA

This option gives you access to music files from your personal storage media, e.g. from storage media connected via USB, and from media servers in your home network to which your TV set is connected.

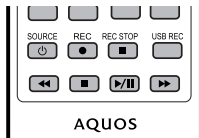

Buttons for audio reproduction

Buttons	Description
button	End reproduction and return to the music selection.
button	Play / Pause the reproduction.
(short) button	Play / Stops the reproduction.
(short) button	DVB radio: Select the previous channel. USB storage or Home network: Go to the top of the track being played, jump/select previous track.
(short)	Select next station/track.
(long)	Only USB storage or Home network: Backwards. Pressing again changes the speed.
(long)	Only USB storage or Home network: Forwards. Pressing again changes the speed.
EPG	Only DVB radio: Shows DVB radio programme guide.

Radio mode

- 1 Press **MENU** button on the R/C, select **Audio/Radio** on the menu and press **OK**.
- 2 Pressing **◀/▶** buttons select **DVB radio** and press **OK**.

Symbols on the screen for radio reproduction

Symbols	Description
	Shows the EPG details for current programme.
	Call function list audio settings.
	Switch off the screen.

Audio mode

- 1 Press **MENU** button on the R/C, select **Audio/Radio** on the menu and press **OK**.
- 2 Pressing **◀/▶** buttons select **USB/DLNA** and press **OK**.

Symbols on the screen for audio file reproduction

Symbols	Description
	Activate/deactivate current playback file repetition.
	Repetition (continuous playback) all audio files of the current folder/directory.
	Random playback of the audio files of a folder.
	Access detailed information about the file being played.
	Call function list audio settings.
	Switch off the screen.

TV menu options



Photo function

Photo mode

You can reproduce photos with JPEG (*.JPE, *.JPG), and PNG format on your TV.

Several kinds of reproduction are possible.

- 1 Select **Photo** menu and press **OK**.
- 2 Pressing **▼** button select **USB/DLNA**. Press **OK** to select the device from which you want to reproduce the files.
- 3 Select the file you want to display on full screen with **◀/▶** buttons and press **OK** to start the viewing.

There is a function list for the selected photo:

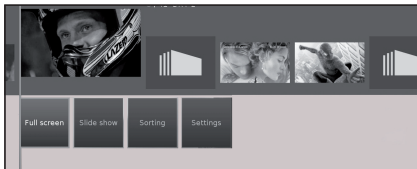

● Full screen

Display the photo on full screen.

● Slide show

Start photo slideshow in the selected directory.

● Sorting

Sort photos in alphabetical order, file size or date.

● Settings

Shows audio settings.

- 4 Select the desired option and press **OK**.

Symbols	Description
	Rotate photo 90° to the left.
	Rotate photo 90° to the right.
	Start slideshow.
	Pause slideshow
	Detailed information on the displayed photo.
	Shows function list with photo settings.
	Stop full screen/slideshow photo and return to photo selection.
	Previous photo display.
	Next photo display.

USB / HOME MEDIA device compatibility

USB 2.0/3.0 device	USB Memory, USB card reader, USB HDD (Mass Storage class)
File system	USB Media Player: FAT / FAT32 / NTFS
Home Network (DLNA)	DLNA 1.5 DMP (Digital Media Player certified)
Photo file format	JPEG, PNG
Music file format	Mpeg 1 (Layer 1 & L2), MP3 Sampling frequency: 8Khz, 11.025 KHz, 12KHz, 16KHz, 22.050KHz, 32KHz, 44.1 KHz, 48 KHz AAC (MP4), WAV (PCM), WMA, AC3 Sampling frequency: 32KHz, 44.1 KHz, 48 KHz
Multimedia Container	TS (Transport Stream), MOV, MP4, MKV, MPG (MPEG2 Programme Stream), WMV, ASF, AVI, DivX, VOB
Video file format	MPEG1, MPEG2, MPEG4, DivX, XVID, AVC/H.264, VC-1, Divx311 (SD Only)

NOTE

- Progressive format jpeg files are not supported.
- Music files in USB 1.1 devices may not be played properly.
- Operation using USB hubs is not guaranteed.
- The external hard disc with capacity exceeding 1TB cannot be detected correctly.
- Cables used to prolong the USB device must be certified as USB 2.0.
- In USB devices, video files may not be played properly if there is not enough speed.
- Playing non-standard encoded files is not guaranteed.
- The file extension does not uniquely specify a file's contents. It is very common for Internet files to have a mismatch between the file extension and its contents; for this reason some files could not be played on this TV set.

TV menu options

AQUOS NET+ function

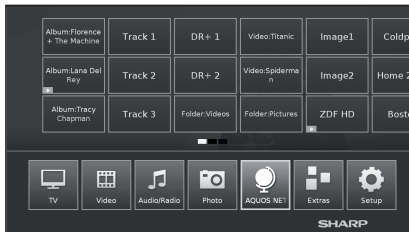

AQUOS NET+ option allows you to access to **AQUOS NET+** feature and Internet browser.

For this option it is necessary that the TV set is connected to Internet (See page 47).

- 1 Press **MENU** button, select **AQUOS NET+** and press **OK**. The next screen appears:



- 2 Press **END** to exit.

What is AQUOS NET+?

AQUOS NET+ is the feature that allows our Internet connected TV sets to easily reproduce digital media content coming from the Network. It provides access to Internet services (Internet browser, YouTube, Facebook and much more)

AQUOS NET+ provides a variety of services for each country.

NOTES

- As **AQUOS NET+** is an online system, it can be modified over time to better serve its purpose.
- Some **AQUOS NET+** services may be added, changed or discontinued after some time.
- Even in open web-mode, users cannot download and save files or install plugins.

DISCLAIMERS

- SHARP Corporation bears no responsibility regarding the content and quality of the content provided by the content service provider.

Operations in AQUOS NET+

Basic Operation

The illustrations on this page are for explanation purposes. They are subject to change without notice.

- **Display the AQUOS NET+ screen**

Press **NET** on remote control or select **AQUOS NET+** on main menu to open **AQUOS NET+** home page.

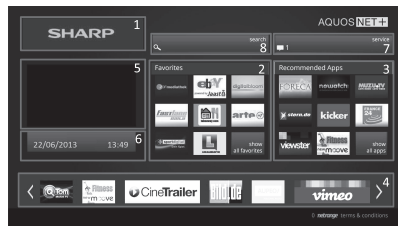

AQUOS NET+ screen is organised into 8 areas:

- 1 AQUOS NET+ title banner
- 2 User-defined Favorites
- 3 Recommended Apps
- 4 Interactive windows for direct brand communications or maintenance functions
- 5 Media window
- 6 Widget Area-real-time functions like date and time or similar
- 7 Sharp Service Center
- 8 Interactive Search window

- **Select a service**

On **AQUOS NET+** screen use **▲/▼/◀/▶** to select the desired service, and then press **OK** to start it.

- Press **↶** to return to the previous page.

You can also use "Search" utility to find specific services, related to a search term.

- Select "Search" and press **OK** to access the search page or start typing to directly search to specific terms.
- To search for a specific keyword, the word is entered using the virtual keyboard (1). The search is executed by clicking Start Search (2). The history of the last search terms can be found on the right side (3).

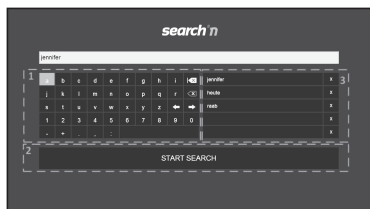

TV menu options

After searching for a specific term, the results are categorized by their type (1), including the number of search results. Categories can be hidden and expanded on request by selecting the close button (2) in the results overview.

Resting the cursor on a search result will bring up a preview overlay (3) with information of the selected content.

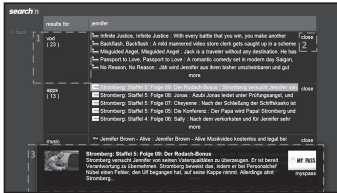

● User sections

The Home Screen is divided in 3 functional areas:



1 Interactive Media Area

This segment is used for the audio-visual presentation of various types of content.

2 Favorite Apps Area

This area presents the top 8 apps of the user-defined favorite applications, including a link to all user-defined favorite applications.

3 Recommended Apps Area

This area presents a selection of recommended apps and also includes a link to the "all apps" screen as described below.

In Area 2 and 3, please use ◀/▶/▲/▼ to select a service you want to access and press **OK**, direction arrows appear around the service logo.

● Favorite Apps Screen

This screen gives an overview of all user-defined favorites. Favorites can be selected in the all-apps screen, as described below. The Top row of apps is presented on the home-screen. The first row (1) is automatically presented in the favorite apps section on the home screen.

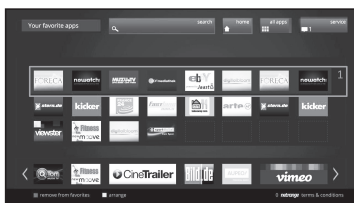

Apps can be re-arranged by the user:

- 1 Move the cursor to the application that shall be moved.
- 2 Use Yellow color key to enter arrange-mode.
- 3 Move selected service to the desired position and press the yellow color key again to confirm the new position.

To dismiss an application from the favorite Apps, place the cursor on the respective app and press the RED color-key on the remote control.

● Exit AQUOS NET+ screen

Press **MENU** button and select **TV** to return to tv mode.

You can also press **ATV**, **DTV**, **SAT** or **RADIO** button to exit.

NOTES

- When connecting the TV to the Internet, a message which requests a software update may be displayed in some cases.
- Some services can request to the user to Login or create a personal account. In this case, please follow the indication on the screen.
- PREMIUM Video-on-Demand (VOD) services are available in some countries.
- The illustrations on this page are for explanation purposes. They are subject to change without notice.
- AQUOS NET+ screen language is adapted to the TV set language previously selected.
- While AQUOS NET+ is active some TV menus or options could be disabled.

Advance Operation

AQUOS NET+ uses alphanumeric characters within some services, which can be introduced using the remote numerical keys, in a similar way that people use a mobile phone keypad. In order to make this task easier, the LE650 is ready to use an external USB keyboard (USB wired, USB-to-Wireless or USB-to-Bluetooth ready) to work only inside **AQUOS NET+**.

When an external keyboard is installed on TV set and the user select **AQUOS NET+**, then the keyboard mapping is:

- 1 ◀ (ENTER)/INTRO = OK (R/C). Used to enter inside any service or to fix data once inside.
- 2 ◀/▶/▲/▼ (U/O/I/K, or u/o/i/k for not extended keyboard). Used to move between services or scroll pages on Left/Right direction.
- 3 ESCape = ⏪ (Return R/C). Return to previous page on services.
- 4 ← (Backspace). Erase last character entered.
- 5 **A.,Z,a,z,0.,9**, and some US symbols (period or dot, commercial at @, underscore, hyphen, exclamation, question, colon, opening parenthesis, closing parenthesis, number, slash, backslash, space). Used for Login, Passwords, Date, and so.

NOTES

- The TV does not support hot plug connection of USB devices like a keyboard. If you wish to connect any other device, please do it when the TV is Power Off or in Standby.
- Inside AQUOS NET+ services, please use standard US characters only (Not extended characters or Special Country Language dependent), in order to avoid problems with the applications.
- Using external USB keyboard is not possible to exit from AQUOS NET+. If necessary, use the **END** remote key.
- Some types of keyboard could show incompatibilities or try to use functions not supported by the TV.

TV menu options

Extras function

Extras option contains additional functions and settings:

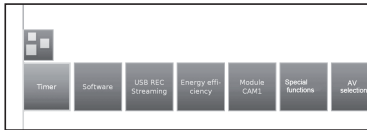

● Timer

In this option you can find your saved Timer Instructions.

● Timer Instructions

All programmed recordings, programmed reminders and copies are listed in this screen. Also it is possible to programme new recordings.

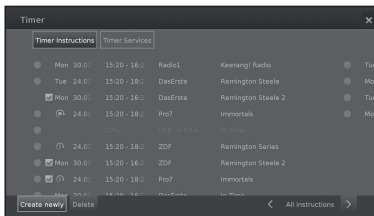

• Create newly

Create new timer instruction.

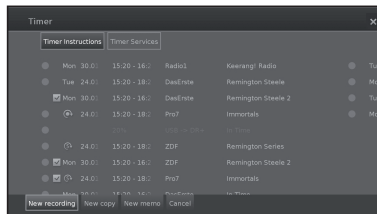

New recording

- 1 With **▲/▼/◀/▶** select **Create newly** and press **OK**.
- 2 With **▲/▼/◀/▶** select **New recording** and press **OK**. The function list for recording will be opened:



● Manual recording:

Programme the recording manually. See page 51.

● Current programme:

Record currently watched programme. Menu item will only be indicated when EPG data is available for the current station. See page 50.

● Following programme:

Record following programme. Menu item will only be indicated when EPG data is available for the current station. See page 50.

● Recording via EPG:

Programme recording of a programme via the electronic programme guide (EPG). See page 50.

● Open USB REC archive

Opens the USB REC archive. See page 51.

- 3 With **▲/▼/◀/▶** select the desired option and press **OK** to proceed.

-New copy

You should copy recordings that you want to save permanently on an external USB hard disk.

- 1 With **▲/▼/◀/▶** select **Create newly** and press **OK**.
- 2 With **▲/▼/◀/▶** select **New copy** and press **OK**. The function list for **USB REC archive** will be opened. See page 49.
- 3 With **▲/▼/◀/▶** select the desired option and press **OK** to proceed.

-New memo (EPG event)

You can set a timer as a reminder for programmes which have not yet started.

- 1 With **▲/▼/◀/▶** select **Create newly** and press **OK**.
- 2 With **▲/▼/◀/▶** select **New memo** and press **OK**. The EPG will be called.

The TV will ask at the beginning of a programme if it should change the channel accordingly.

-Delete

Use this function in the overview of timer instructions if you want to delete recordings already programmed or end a running timer recording.

- 1 With **▲/▼/◀/▶** select **Delete** and press **OK**.
- 2 With **▲/▼** select the timer instruction to be deleted and press **OK**. Ahead of the entry appears a delete icon .
- 3 With **▲/▼/◀/▶** select **Confirm delete** option and press **OK** to delete timer instructions.

Select **Cancel** to return to **Timer Instructions**.

NOTE

- When you have programmed timer recordings, the TV can only be switched off in the standby mode.

● Software

This option allows you to have the TV software version always updated. You can download new software from different sources:

● Software update

● Via USB

Current software version can be downloaded from the SHARP Internet site and installed on your TV using a USB memory.

TV menu options

- **Via Internet**

The software update wizard appear.

See page 27 for more information.

- **Via antenna**

The software update wizard appear.

- **Energy Efficiency**

Decide how energy efficient the TV shall be.

- **Home Mode:**

The emphasis for home use is on low energy consumption.

The automatic dimmer is activated.

- **Shop Mode:**

The picture settings are aligned to operate in the presentation room. The automatic dimmer is deactivated. If the ambient brightness diminishes, the energy consumption is not reduced.

- **CA module(s)**

In order to receive coded digital stations, a Common Interface Module (CI Module) and a CA Card must be inserted in the CI slot of the TV.

See page 8 for more information.

- **Special functions**

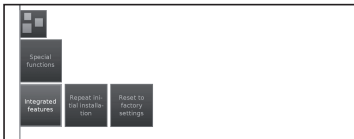

- **Integrated features**

Shows information about TV's integrated features.

- **Repeat initial installation**

This option allows you to repeat all steps for initial installation. See the procedure at page 9.

NOTE

- All stored stations and all personal lists will be deleted.

- **Reset to factory settings**

Allows you to reset **Picture/Sound** and **Network** settings.

- **AV selection**

Allows you to select the AV source.

If the selected AV source provides a signal it should be visible now.



Setup function

Here you can find all settings and adaptabilities of the TV set.

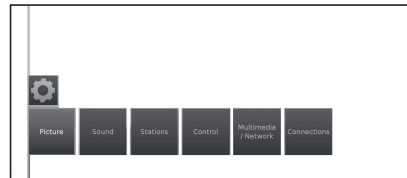

- **Picture**

Allows you to adjust the settings according to the representation of the picture signal on the TV.

See page 21 for more information.

- **Sound**

Allows you to find the settings for sound playback.

The sub-items of the menu depend on the currently selected sound component.

See page 21 for more information.

- **Stations**

Move and delete TV and radio stations. In addition to that you can automatically and manually update the complete station list. The stations can also be arranged and optionally sorted in personal lists.

See page 22 for more information.

- **Control**

In this menu you find settings for additional functions of the TV set such as digital recorder (USB REC) as well as interfunctional settings like time and date, parental lock or software update.

See page 24 for more information.

- **Multimedia/Network**

In this menu you can configure your network adapter and network access. Also you can make settings for video and music playback here.

See pages 28 and 47 for more information.

- **Connections**

In this menu you can configure external devices that are connected to the TV.

See page 28 for more information.

Connecting external devices

● Before connecting ...

- Be sure to turn off the TV and any devices before making any connections.
- Firmly connect a cable to a terminal or terminals.
- Carefully read the operation manual of each external device for possible connection types. This also helps you get the best possible audiovisual quality to maximise the potential of the TV and the connected device.

Introduction to connections

The TV is equipped with the terminals as shown below. Find the cable corresponding to the TV's terminal and connect the device.

NOTE

- The cables illustrated in pages 41, 42 and 43 are commercially available items.

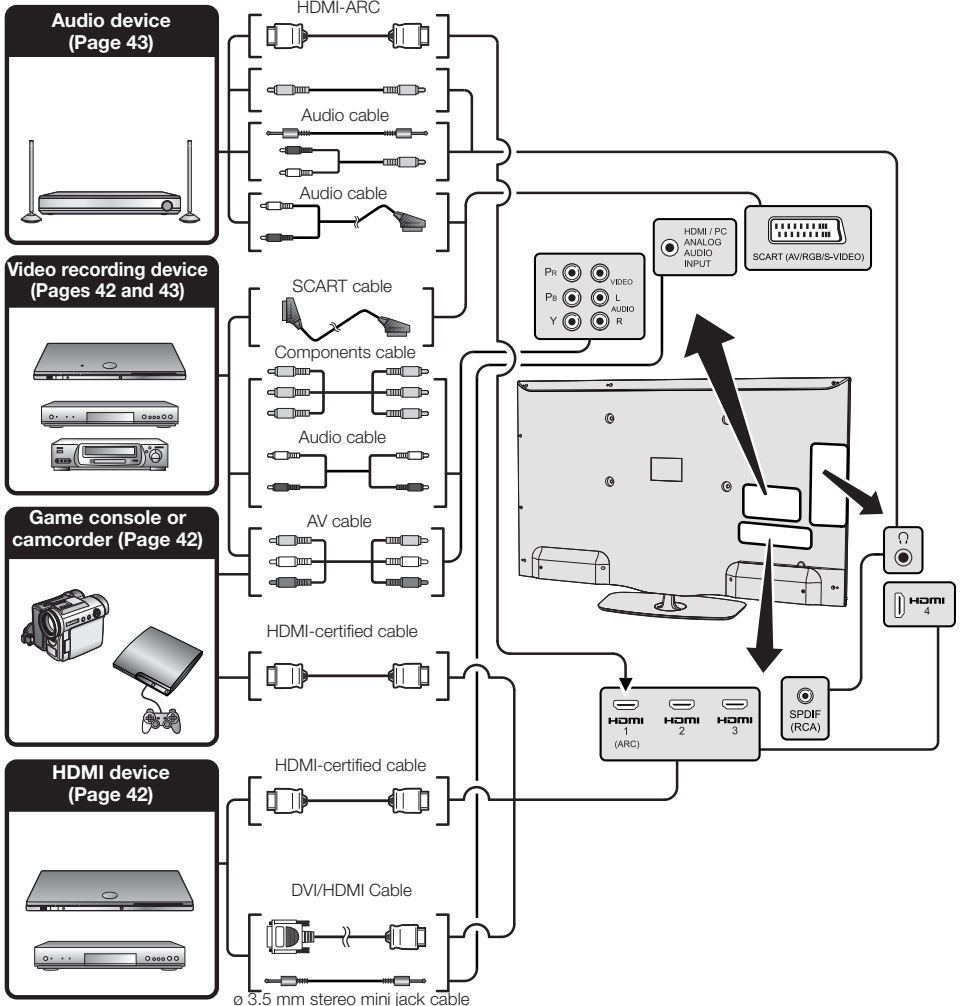

Connecting external devices

HDMI connection

Example of connectable devices

- DVD player/recorder
- Blu-ray player/recorder
- Game console

The HDMI connections permit digital video and audio transmission via a connection cable from a player/recorder. The digital picture and sound data are transmitted without data compression and therefore lose none of their quality. Analogue/digital conversion is no longer necessary in the connected devices, which also would result in quality losses.

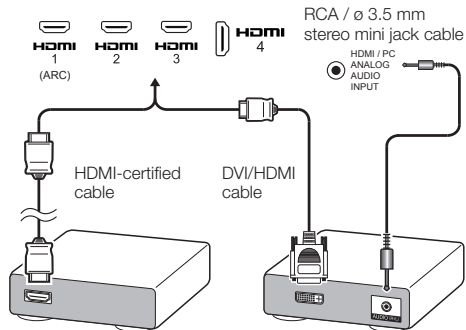

DVI/HDMI conversion

Using a cable DVI/HDMI, the digital signals of a DVD video, can also be reproduced through a compatible HDMI connection. The sound should be supplied additionally.

- On connecting a DVI/HDMI cable to the HDMI terminal, the picture may not be visualised clearly.
- Both HDMI and DVI use the same method of HDCP protection against copy.
- For connecting a DVI cable, a commercially available adaptor (not supplied) is necessary.

NOTE

- Depending on the type of HDMI cable used, a video noise may appear. Be sure to use a certified HDMI cable.
- On reproducing HDMI picture, the best format is automatically detected and adjusted for the picture.

Compatible video signal

576i, 576p, 480i, 480p, 1080i, 720p, 1080p

Component connection

Example of connectable devices

- VCR
- DVD player/recorder
- Blu-ray player/recorder

You will enjoy accurate colour reproduction and high quality images through the INPUT COMPONENTS / AV terminal when connecting a DVD player/recorder or other device.

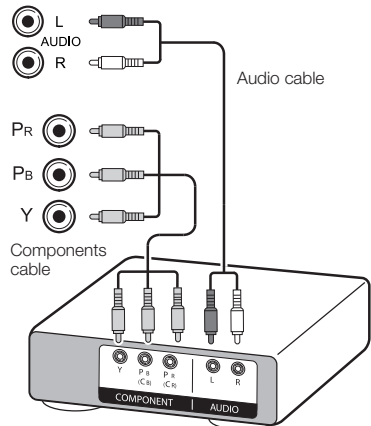

VIDEO connection

Example of connectable devices

- VCR
- DVD player/recorder
- Blu-ray player/recorder
- Game console
- Camcorder

You can use the COMPONENTS/AV terminal when connecting to a game console, camcorder, a DVD player / recorder or other device.

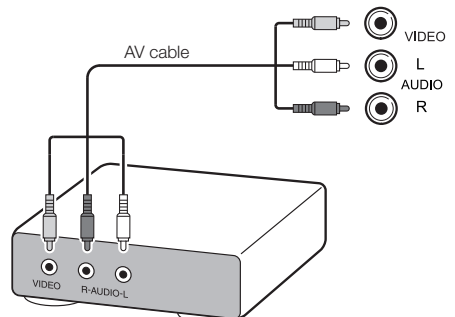

Connecting external devices

SCART connection

Example of connectable devices

- VCR
- Decoder
- DVD player/recorder

SCART cable

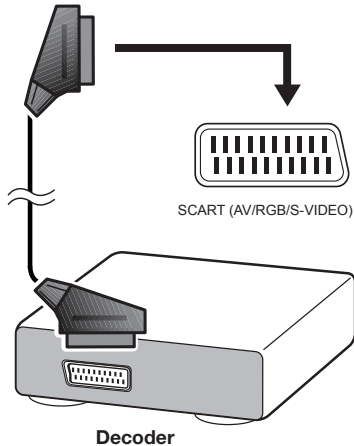

NOTE

- In cases when the decoder needs to receive a signal from the TV, make sure you select the appropriate input terminal to which the decoder is connected in "AV selection" (Page 17).

Speaker/amplifier connector

Example of connectable devices

- Connecting an amplifier with digital audio input

Connect an amplifier with external speakers as shown below.

RCA Audio cable

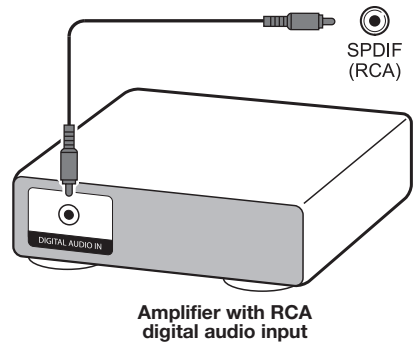

• After connecting

Digital audio output setting

After connecting an amplifier with RCA digital audio input as shown, you should set an audio output format compatible with the programme you are watching or the device connected.

Press **MENU** and go to **Setup** → **Sound**
→ **SPDIF mode** → select **PCM** or **Dolby Digital**.

NOTE

- When you set this to **Dolby Digital**, and you receive the Dolby Digital or Dolby Digital Plus audio formats, Dolby Digital audio is output. Otherwise, PCM audio is output.
When you set this to **PCM**, PCM audio is output no matter what audio formats you receive.

HDMI devices

Controlling HDMI devices using HDMI CEC

● What is HDMI CEC?

Using the HDMI CEC protocol, you can interactively operate compatible system devices (AV amplifier, DVD player/recorder, Blu-ray player/recorder) using a single remote control unit.

NOTE

- HDMI CEC does not work while using **USB REC** functions.

● What you can do with HDMI CEC

● One touch play

When the TV is in standby mode, it will automatically turn on and play back the image from the HDMI source.

● Single remote control operation

HDMI CEC automatically recognises connected HDMI devices and you can control the TV and the devices as if using a universal remote control unit.

● Operating title list of external devices

In addition to displaying the TV's own timer list (Page 36), you can also call up the external player's top menu or player's / recorder's title list provided that the devices support HDMI CEC.

NOTE

- When you use HDMI CEC, be sure to use a certified HDMI cable.
- Point the remote control unit towards the TV, not to the connected HDMI device.
- Video noise may occur depending on the type of HDMI cable used. Be sure to use a certified HDMI cable.
- Up to three HDMI recording devices, one AV amplifier and three players can be connected using this system.
- These operations affect the HDMI device selected as the current external source. If the device does not operate, turn on the device and select the appropriate external source using **↵**.
- When you insert/remove HDMI cables or change connections, turn on all connected HDMI devices before turning on the TV. Confirm that picture and audio are correctly displayed/output by selecting "HDMI 1", "HDMI 2", "HDMI 3" or "HDMI 4" from the "AV selection" menu.

HDMI CEC connection

First connect the speaker system or a player/recorder that supports the HDMI CEC protocol.

NOTE

- Refer to the operation manual of the device to be connected for further details.
- After unplugging connection cables or changing the connection pattern, turn on the power of the TV after all the power of relevant devices has been turned on. Change the external input source by pressing **↵**, select the appropriate external source and verify the audiovisual output.
- The cables illustrated in the following explanation are commercially available items.

Connecting a player/recorder via the speaker system

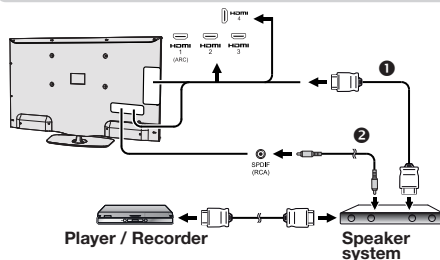

- ① HDMI-certified cable (commercially available)
- ② RCA audio cable (commercially available)

Connecting a player/recorder only

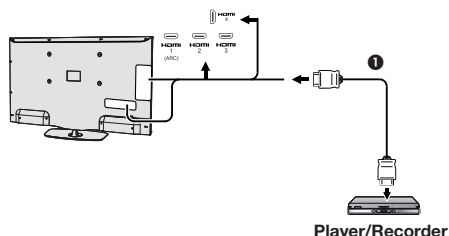

- ① HDMI-certified cable (commercially available)

HDMI CEC (Consumer Electronics Control) menu

Basic operation

Go to **Menu**→**Setup**→**Connections**→**HDMI CEC** and select the menu you want to set.

HDMI CEC functionality

Set to **On** to enable HDMI CEC functions.

Remote TV switch on via HDMI-CEC (One-touch play)

If this is activated, the one touch play function is enabled. While the TV is in standby mode, it automatically turns on and plays back the image from the HDMI source.

NOTE

- The factory default for this item is "Off".

Operating a HDMI CEC device

When a device that supports HDMI CEC is connected, the R/C of TV does not work.

By short pressing of **SOURCE** button the R/C will be operational again and TV goes to TV mode.

By long pressing of **SOURCE** button the TV return to HDMI-CEC mode.

Connecting a PC

PC connection

HDMI (DVI) Connection

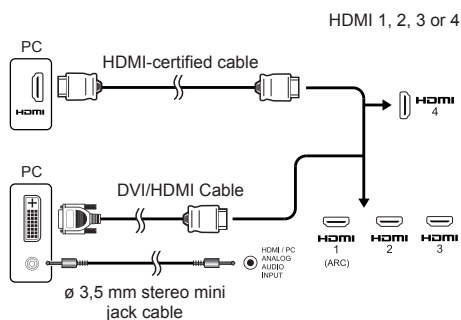

After connection

- If after connecting a PC to the TV through a HDMI cable, the audio does not run, connect a mini stereo connector of ø 3.5mm between TV and PC as indicated in the previous drawing.
- When a PC is connected to the TV with a DVI cable, it will be necessary to connect a mini stereo connector of ø 3.5mm of the TV to PC as indicated in the previous drawing.

Analogue Connection

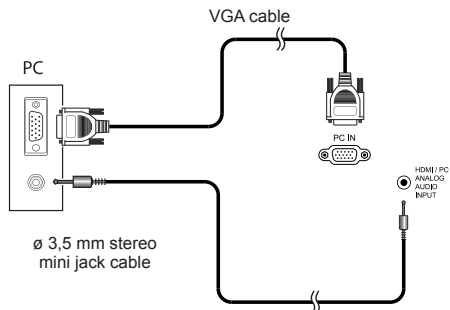
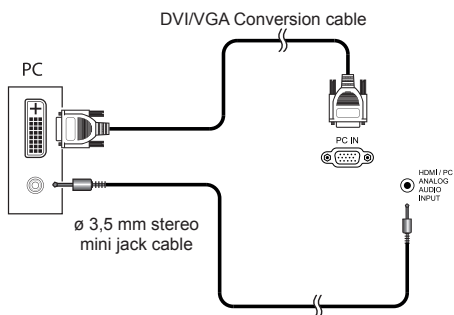

NOTE

- When using the PC-IN terminal it is necessary to connect an audio cable.

Selecting the picture size

You can select the picture size.

- 1 Press **MENU** on the remote control.
- 2 Select **Setup** → **Picture** → **Picture format**, then press **OK**.
- 3 Press **◀/▶** key to select the desired item, then press **OK**.

Example

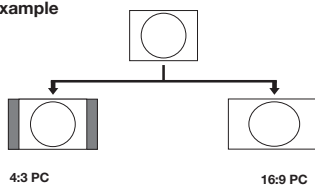

Item	
16:9 PC	Proportionally correct display of 16:9
4:3 PC	Proportionally correct display of 4:3

NOTE

- You can also select an item by pressing **⏪** on the remote control unit.
- Connect the PC before making adjustments.
- Selectable picture size may vary with input signal type.

Connecting a PC

Adjusting the PC image automatically

This function enables the screen to be automatically adjusted to its best possible condition when the analogue terminals of the TV and PC are connected with a commercially available DVI/VGA conversion cable, etc.

- 1 Press \rightarrow to select **PC-IN** from **AV selection**, and then press **OK**.
- 2 Press **MENU** key.
- 3 Press \blacktriangleright key to select **Setup** and press **OK**.
- 4 Press \blacktriangledown key to select **Picture** \rightarrow **more...** and press **OK**.
- 5 Press \blacktriangleright key to select **PC IN display** and press **OK**.
- 6 Press \blacktriangledown key to select **Auto Adjustment** and press **OK**.

NOTE

- When connecting a PC and select **PC-IN** source, the **"Auto adjustment"** is executed automatically.
- **"Auto adjustment"** may fail if the PC image has low resolution, has unclear (black) edges, or is moved while executing **"Auto adjustment"**.
- Be sure to connect the PC to the TV and switch it on before starting **"Auto adjustment"**.
- **"Auto adjustment"** can be executed only when inputting analogue signals through the "PC IN" terminal.

Adjusting the PC image manually

Ordinarily you can easily adjust the picture as necessary to change image position using **"Auto Adjustment"**. In some cases, however, manual adjustment is needed to optimise the image.

- 1 Press \rightarrow to select **PC-IN** from **AV selection**, and then press **OK**.
- 2 Press **MENU** on the remote control.
- 3 Select **Setup** \rightarrow **Picture** \rightarrow **more...**, then press **OK**.
- 4 Press \blacktriangleright key to select **"PC IN display"**, then press **OK**.
- 5 Press $\blacktriangle/\blacktriangledown$ key to select the desired item, then press **OK**.
- 6 Press $\blacktriangleleft/\blacktriangleright$ to adjust the item to the desired position.

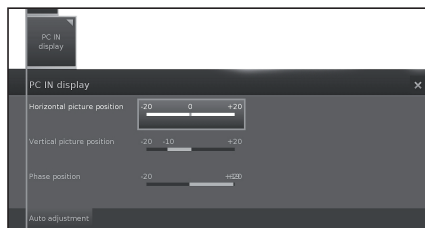

Item	
Horizontal picture position.	Centres the image by moving it to the left or right.
Vertical picture position	Centres the image by moving it up or down.
Phase position	Adjusts when characters have low contrast or when the image flickers.
Auto Adjustment	Automatically adjusts the image

NOTE

- The **"PC IN display"** options in the **"Picture"** menu can be adjusted only when inputting analogue signals through the "PC IN" terminal.
- Depending on resolution, the vertical/horizontal manual range can be different.

PC compatibility chart

Resolution		Horizontal Frequency	Vertical Frequency
VGA	640 × 480	31,5 kHz	60 Hz
SVGA	800 × 600	37,9 kHz	60 Hz
XGA	1.024 × 768	48,4 kHz	60 Hz
WXGA	1.360 × 768	47,7 kHz	60 Hz
SXGA	1.280 × 1.024	64,0 kHz	60 Hz
SXGA+	1.400 × 1.050	65,3 kHz	60 Hz
UXGA	1.600 × 1.200	75,0 kHz	60 Hz
1080p	1.920 × 1.080	67,5 kHz	60 Hz

VGA, SVGA, XGA, WXGA, SXGA, SXGA+ and UXGA are registered trademarks of International Business Machines Corporation.

NOTE

- This TV has only limited PC compatibility, correct operation can only be guaranteed if the video card conforms exactly to the VESA 60 Hz standard. Any variations from this standard may result in picture distortions.

Multimedia/Network Setup

Network Setup

Connecting to the network

To enjoy internet services, you need to connect the TV to a router with a high speed connection to the internet. You can also connect the TV to your Home network server through a router or access point.

The TV connection to the router can either be wired or wireless.

To access the TV internet configuration go to **Setup**→**Multimedia/Network**→**Network settings**→**Networking**. The next screen is shown:

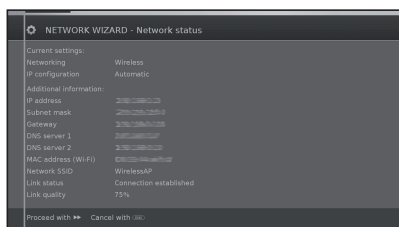

Press **▶▶** to continue the installation. Choose between **Wired** or **Wireless** connection.

NOTE

- If you choose a wired connection to the router, you need an ETHERNET cable (not included, commercially available).
- If you do not have a broadband internet connection, consult the store where you purchased your TV or ask your internet service provider or telephone company.
- Wired and wireless connection cannot be used at the same time. Use only one of the connection types.
- A wireless LAN connection and performance cannot be guaranteed for all residential environments. In the following cases, the wireless LAN signal may be poor or drop, or the connection speed may become slower.
 - When used in buildings made with concrete, reinforced steel, or metal.
 - When placed near objects that obstruct the signal.
 - When used with other wireless devices that emit the same frequency.
 - When used in the vicinity of microwave ovens and other devices that emit a magnetic field, electrostatic charge, or electromagnetic interference.
- A stable connection speed is required to play back streaming content. Use a wired LAN connection if the wireless LAN speed is unstable.

Wired installation

Use an ETHERNET cable to connect the LAN terminal on the TV to your broadcast router as shown below. This is recommended when enjoying services which require stable connection speeds, such as streaming media.

• Wired connection overview

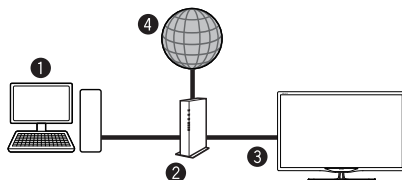

- 1 PC (Home Media Server)
- 2 Router (commercially available)
- 3 ETHERNET cable (commercially available)
- 4 Network (Internet)

• How to connect

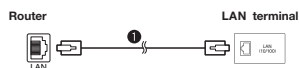

- 1 ETHERNET cable

1 Switch on the router (commercially available). Refer to the router's operation manual for switching on.

2 Connect the LAN terminal on the TV to the router (commercially available) with an ETHERNET cable (commercially available).

3 Go to **Setup**→**Multimedia/Network**→**Network settings**→**Networking**.

4 Press **OK** and **▲/▼** to select **"wired"**, and then press **OK**.

5 Select type of **IP configuration**:

Automatic: Automatic configuration of the IP address via DHCP server or via multiple protocols according to UPnP specification.

Manual: Enter your fixed static IP addresses manually. (Ask your internet service provider).

6 Press **OK**.

Wireless installation

Use the SHARP (AN-WUD630) USB adapter with the TV.

• Wireless connection overview

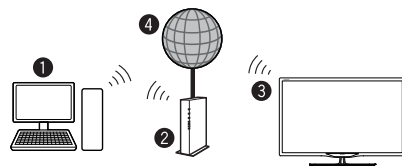

- 1 PC (Home Media Server)
- 2 Wireless LAN router/access point
- 3 Wireless AN-WUD630 LAN USB adapter (Sold separately)
- 4 Network (Internet)

NOTE

- When using the SHARP wireless LAN adapter, try to provide as much free space around the device for best performance.
- Make sure the firewalls in your network allow access to the TV wireless connection.

Multimedia/Network Setup

- Operations cannot be guaranteed when used with access points that do not have Wi-Fi® certification.
- A wireless LAN access point is required to connect the TV to the Internet using a wireless LAN. See the operation manual of your access point for setup.

• How to connect

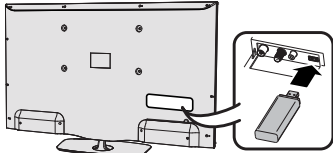

- 1 Switch on your router/access point before starting the network installation.
- 2 Connect the AN-WUD630 USB adapter to the USB Wi-Fi port on the TV.
 - Do not use a wireless LAN adapter other than the AN-WUD630 Sharp wireless LAN adapter, as operations cannot be guaranteed.
 - If your wireless network is secured, have the encryption key ready to enter on screen.
- 3 Go to **Setup**→**Multimedia/Network**→**Network settings**→**Networking**.
- 4 Press **OK** and **▲/▼** to select “wireless”, and then press **OK**.

The “Wireless” connection will be automatically selected if the TV detects only the wireless USB adapter.

The TV starts to search for wireless routers/access points.

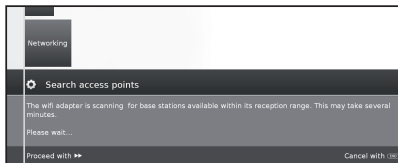

- 5 Select required router/access point and press **OK**. As soon as **◀◀** is displayed, you can go back one installation step by pressing this button.
- 6 If your network has an access code, it is necessary to enter the code that allows access to the network. A screen keyboard will appear to enter the password. Press **OK**.
- 7 Select IP address assignment method. You can choose between: **Automatic (DHCP)** or **Manual (Input Static IP Address)**.

Automatic (DHCP): IP address is automatically issued by a DHCP server on your home network.

- A DHCP server has to be set up on a device on the network (WLAN router/access point).

Input Static IP Address: IP address is entered manually. Use the RC alphanumeric buttons, to input digits of IP address.

Press **▶▶** to continue.

Afterwards you will see a summary of the settings.

- 8 Press **▶▶** to confirm settings.

NOTES

- To connect your TV to the internet, you must have a broadband internet connection.
- If you do not have a broadband internet connection, consult the store where you purchased your TV or ask your internet service provider or telephone company.
- There is no need to enter the security key for subsequent connections to the wireless network.

If your access point is set to a stealth mode (Hidden SSID, that prevents detection by other devices), you need to use manual method to enter the SSID name for desired access point.

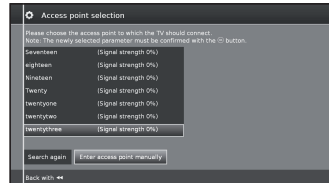

- 1 Select **Enter access point manually** and press **OK**. Introduce the SSID name using the on-screen keyboard.
- 2 Select **Adopt** and press **OK** to fix the name.
- 3 Select **Encryption method** and press **OK**.

Only if your access point is secured a WEP key or a WAP password will be required.

- 4 Repeat the process from point 7 of previous explanation.

To change wireless LAN connection settings, go to **Setup** → **Multimedia/Network** → **Network settings** → **Networking**.

NOTES

- Any low bandwidth adapter (router, hub, wireless access point,...) will show poor network connection and then, poor streaming quality. It is recommended 56 Mbps or higher bandwidth for full feature.
- Working in close proximity to other Wireless/Bluetooth networks, may cause some trouble using a Wi-Fi adapter on the internet connected TV. Because the wireless link cannot be guaranteed, please try to change the Wi-Fi channel on the Access Point (AP) to avoid interference. Please refer to Access Point User Manual.
- Home Media (DLNA) requires external streaming media software installed on a PC, inside the HOME Network, that is not included with AQUOS NET+.
- Home Media (DLNA) server software as Windows Media Player 11 (Windows Vista included) or Windows Media Player 12 (Windows 7 included), TVeristy (www.tveristy.com), Nero Media Home (www.nero.com), or Twonky Media Manager (www.twonky.com) are preferred but others can also be used. Visit the DLNA website (www.dlna.org) to see the certified media server list. Follow the server software's user manual for setup, share and stream media contents.
- Home Media (DLNA) (Video, Music and Photo) data is organised in folders depending on the Server hierarchy; options such as Artist, Genre, Composer, Ratings, Playlist or Watch Folders may be present for sorting content, but can be different depending on the selected Media Server.
- The “Play To” function of some PC Media Players may result in very compressed video quality. For best video quality, please use the USB Media Player function of the TV.

USB REC function

USB REC function

USB REC (Video Recorder)

USB REC function allows you to record a TV programme and watch it later. It also allows you to schedule one or more recordings and they will be available to view later on.

If EPG or teletext data are available, the USB REC stores the title and additional information about each programme.

If additional languages are being transmitted for a DVB broadcast, these are also recorded. DVB subtitles or teletext subtitles are recorded if the recording of subtitles has been activated in the USB REC settings.

USB REC requires an external USB 2.0 memory or a hard disk, always connected and previously configured to record the information.

The first USB device connected appears as USB1 terminal.

The USB memory must be formatted before first use for USB REC function.

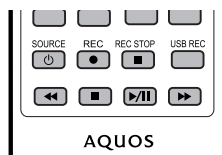

Manual recording

Record interesting programmes directly into USB memory with the **USB REC** button. When viewing time-shift broadcasts the current broadcast can be saved to the USB memory. The programme is recorded from the beginning to the end of the time offset recording or to the end of the set recording time.

Timer-controlled recording

Select your favourite programme for recording, from the EPG. The timer overview has room for 50 entries. Watch the programmes later from the USB memory.

Serial recording

You can conveniently programme series broadcast with alternating start times.

Time shift viewing with archive recording

If you are recording a programme and would like to watch it before it has finished, you can watch the movie with a time shift while the rest is still being recorded.

Archive playback

Select **▶▶** on the screen during playback to fast forward. By selecting **▶▶** repeatedly, allows you to increase the fast forwards speed.

Select **||** on the screen and press **OK** button to restore the normal speed.

By selecting **▶▶▶** on the screen the recording fast forwards in intervals of two minutes.

Select **◀◀** on the screen during playback to rewind. By selecting **◀◀** repeatedly, it allows you to increase the rewind speed.

Select **||** on the screen and press **OK** button to restore the normal speed.

By selecting **◀◀◀** on the screen the recording rewinds in intervals of two minutes.

USB REC settings

You can make a few settings in the USB REC menu to adapt it to your requirements.

Go to **MENU**→**Setup**→**Control**→**more**→**USB REC**, then press **OK**:

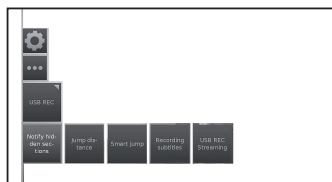

● Notify hidden sections

If an entry has been hidden in an archive recording, you can be informed by a screen message when skipping a hidden area. The factory default is set to **yes**.

● Jump distance

Set the standard jump width (in minutes) used from jumping forwards or backwards in the film by pressing **◀◀** or **▶▶**. Use the numeric buttons on the remote control to enter the time.

- If **Smart jump** is activated, the jump width can only be set between 1 and 4 minutes.

● Smart Jump

If **Smart Jump** is activated, the jump width is halved every time you change the jump direction. The jump width is doubled if you jump more than three times in the same direction (max. 8 min.).

● Serial recording tolerance

A broadcast programmed with the recording type **Serial** is recorded if it begins within the programmed start time ± series recording tolerance. Use the numeric buttons on the remote control to enter the time (always two-digit for 01 to 60 min.).

USB REC function

● Recording subtitles

Select here whether subtitles are to be recorded for DVB stations.

Manual recording

With **USB REC** button, the recording starts immediately at the press of a button. You only need to specify the recording time.

- 1 Press **USB REC** button. The **Recording duration** screen is called.

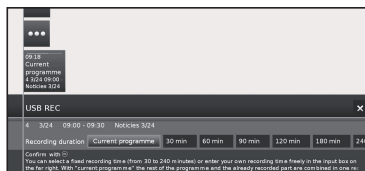

● Current programme

The broadcast being watched is recorded on to a USB memory or on to a hard disk.

● **30 min/ 60 min/ 90 min/ 120 min/ 180min /240min**
Allows you to choose the recording duration.

● ????

Manually enter the recording duration with the numeric buttons of the remote control.

- 2 Select desired recording time with **◀/▶** buttons. Press **OK** to confirm.

- 3 The **Timer data** screen appears.

Check the timer data, change if necessary and confirm with **OK**. The recording will start and the recording progress bar will be displayed for a moment.

While recording is activated, the status indicator (AQUOS pyramid) lights up violet.

You can end a current recording prematurely by pressing **■** button and **OK** button.

NOTE

If there is no teletext or EPG programme information, the recording duration menu will appear the first time you press the **▶** button. Select the desired recording duration and confirm using **OK**.

Programming a timer recording with EPG

You can programme timer recordings for USB REC using the EPG.

When you have programmed timer recordings, the TV set can only be switched off to the standby mode.

If you switch the TV set off by the mains, no timer recordings will be made.

- 1 Press **EPG** button.
- 2 Select the broadcast to be recorded.
- 3 Press **REC(●)** button. Recording screen is opened.

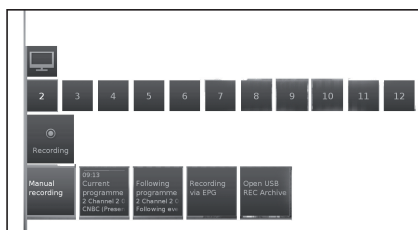

See **Recording** in page 32 for more information.

USB REC function

Programming a timer recording manually

You can programme timer recordings for USB REC manually.

Set the TV to TV mode, select the station to be recorded.

- 1 Press **OK** button and select **Recording**→**Manual recording**.

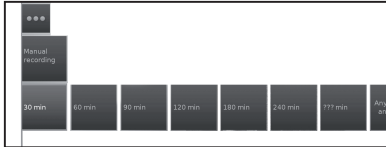

- 2 Choose between **30 min- 240 min** and press **OK**.

The **Timer Data** menu is displayed. Check the timer data and change if necessary.

- 3 With **▲/▼/◀/▶** select the station or connection socket to be recorded.
- 4 Select **Adopt to timer** and press **OK**. The broadcast is entered into the timer overview.

If a DVD recorder was selected as a recording source, start playing the connected device manually from the beginning of the entered recording time.

If you switch the TV set off by the mains, no timer recordings will be made.

Delete programmed timer entries

Use this function in the timer overview if you want to delete recordings already programmed or end a running timer recording.

- 1 Press **MENU** button and go to **Extras**→**Timer**, press **OK** and the recordings already programmed are displayed.

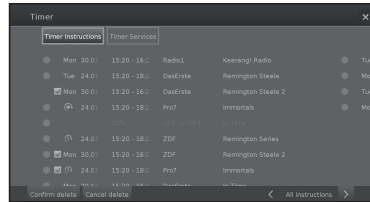

- 2 With **▲/▼** select the timer entry to be deleted and press **OK**.
- 3 With **▲/▼** select **Confirm delete**.
- 4 Press **OK** to confirm.

The letters of a timer currently active are red. If you delete this timer, the recording is stopped.

Archive playback settings



Playing from the archive

- 1 Press **MENU** button and go to **Video**→**USB REC archive**.
- 2 With **◀/▶** select the recording.
- 3 Press **OK** to start playback.

Setting bookmarks

While playing an archive recording, you can set bookmarks.

- 1 By pressing **▲/▼** button the play progress bar will be displayed.
- 2 Press **▶** (PLAY) button for a little longer to set bookmark. Every time the **▶** (PLAY) button is pressed down again a little longer, a new bookmark is set.
- 3 You will see the message:
A bookmark was set!

You can set up to 15 bookmarks per recording.

USB REC function

Jumping to bookmarks

- 1 Press **[+]** button and progress bar display appears.
- 2 Press **Blue** button to next bookmark.

Delete individual bookmarks

- 1 Press **[+]** button and progress bar display appears.
- 2 With **[] / []** select the bookmark you want to delete.
- 3 Select **[]** and press **OK** to delete selected bookmark.

Jumping

- 1 Press **[+]** button and progress bar display appears.
- 2 With **[] / []** you can jump forwards and backwards through the recording archive.

Smart Jump

Allows you to search quickly for certain scenes of a recording.

For more information see page 49.

Fast forward and rewind

During time shift viewing you can fast forward and rewind at different speeds. Sound is not audible during winding.

- 1 Press **[+]** button and progress bar display appears.
- 2 With **[] / []** you can fast forwards/backwards.

For more information see **Archive playback** on page 49.

Pause (freeze picture)

- 1 Press **[]** button to switch to freeze picture.
- 2 Press **[]** button again to continue playback.

Deleting parts of the recording

You can delete sections of a recording from the current position within the film to the beginning or to the end.

- 1 During the archive playback press **[]** button at the point from which the archive recording is to be deleted.
- 2 Select **[]** on the progress bar and press **OK** to call **Delete/Hide** menu.
- 3 With **[] / []** buttons select **Delete to start** or select **Delete to end**.
- 4 Select **Confirm delete** and press **OK**.
- 5 Select **Cancel** and press **OK** to abort delete.

Hiding sections of the recording

You can hide sections of an archive recording. The hidden parts are skipped in the future playback and when copying to a connected recorder.

- 1 During the archive playback press **[]** button at the point of the recording where the hide is to begin.
- 2 Select **[]** on the progress bar and press **OK** to call **Delete/Hide** menu.
- 3 With **[] / []** buttons select **Hide** to set the start of the section to be hidden.
- 4 Press **[]** to continue playback or **[] / []** skip/wind to the point where the hide is to end.
- 5 Press **Yellow** button to set hiding end.

The hidden area of the recording is shown red in the bar. In future it will be skipped during playing.

If in the settings of the Control → **USB REC** → **Notify hidden sections** → **yes** is set, you will see a screen message, if the hidden area has been reached during playback.

- 6 Press **Blue** button during the screen message to show hidden area again permanently.

Slow motion

At an active pause (freeze frame) you can select from four slow motion speeds (for wind/rewind). There is no sound during slow motion replay.

- 1 Press **[+]** button and progress bar display appears.
- 2 Press **[]** button to switch to freeze picture.
- 3 Select **[] / []** and press **OK** to start slow motion.
- 4 Press **[]** button again to continue playback.

The speed increases every time you press the button until eventually switching back to the initial speed.

USB REC archive function list

The function list of USB REC archive contains individual functions for its archive entries.

- 1 Press **MENU** button and go to **Video** → **USB REC archive**.
- 2 With **[] / []** buttons select the archive.
- 3 Press **[]** button to open the functions list for the archive selected.

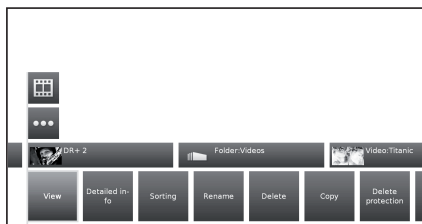

USB REC function

• View

Start or continue replaying the selected archive entry.

• Detailed info

Show detailed information on the marked archive entry.

• Sorting

Sort archive entries in alphabetical order or according to recording date (newest first).

• Rename

Change title or archive entry.

• Delete

Delete archive entry from USB memory or hard disk.

• Copy

Copying an archive entry to another hard disk or USB memory.

• Repeat

Play archive repeatedly (in a loop) when the archive entry is replayed in the future.

• Settings

Opens the video settings.

Further information can be found on page 33.

TV viewing with time shift

The USB REC continuous operation is switched on as the factory default setting. In this case the TV broadcast that you wish to view is automatically recorded in the background.



NOTES:

- Recommend that you use a hard disk (HDD) for this function.
- Is necessary to have 8Gb free minimum for a correct functionality of TimeShift.
- The TimeShift recording has a durability of maximum 3 hours.

Pause

Press **||** button. The TV images becomes a freeze frame and TimeShift status display appears.

Continue time shift viewing

Press **||** button. You can now watch the TV programme with a time shift from the time you pressed the **||** button for the first time. The **▶** symbol appears in place of the **||** symbol.

Switch to live picture

Press **■** button. You see the station's live picture again.

Setting bookmarks

To retrieve interesting scenes later, you can manually set the bookmarks.

With **▲/▼/◀/▶** select on screen  and press **OK**.

In addition, there are also automatically set bookmarks every time the broadcast is changed.

Jump to automatically set bookmarks

With time-shift television, and with the progress bar display showing, you can skip to automatically set bookmarks.

With **▲/▼/◀/▶** select on screen:

 : Jump back

 : Jump forward

Jumping

You can jump during time shift viewing by selecting on screen **◀◀/▶▶**.

Smart Jump

If **Smart Jump** is activated, the jump width is halved every time you change the jump direction. The jump width is doubled if you jump more than three times in the same direction (max. 8 min.).

Fast forward and rewind



During time shift viewing you can fast forward and rewind at three different speeds. Sound is not audible during winding.

Select on screen **◀◀** or **▶▶** and press **OK**.

Every time you press **OK**, the speed will increase. Select **▶▶** to return to normal view.

Delete bookmarks

Press **||** button and TimeShift display appears.

With  /  select the bookmark you want to delete.

Select  and press **OK** to delete selected bookmark.

Enjoying 3D image viewing

Enjoying 3D image viewing

You can enjoy 3D-supported images on the TV when you wear 3D glasses (AN-3DG20-B or AN-3DG35), sold separately.

Confirm how to use the 3D glasses before watching 3D-supported images. These 3D glasses are only for use with SHARP LCD TVs supporting 3D.

Explanation of 3D settings

● 2D->3D

If you set this adjust to **on**, all 2D images will be displayed in 3D. You will need to wear the 3D glasses to view it properly.

● 3D mode

● Off

Here you can deactivate the 3D mode of the TV. The TV shows the 2D/3D images in the same way as it is provided by the station or external player.

● Automatic

If the TV is set to this setting (factory setting), then the TV automatically switches over to the correct 3D mode if it is possible.

Only change the setting if the 3D content is not displayed correctly.

● Side by side

To display 3D content in **side by side** format. When viewing 3D content with this setting, two almost identical images are displayed next to each other and are put together correctly by the TV set.

● Top/bottom

To display 3D content in **top/bottom** format. When viewing 3D content with this setting, two almost identical images are displayed one above the other and are put together correctly by the TV set.

Viewing 3D images

- 1 Select the 3D source (HDMI).
- 2 Press **3D** button on remote control.



NOTE

- The TV screen may temporarily become black when the TV is trying to detect a 3D image signal and when switching from 3D to 2D mode.

Receiving a 3D image signal that can be detected automatically

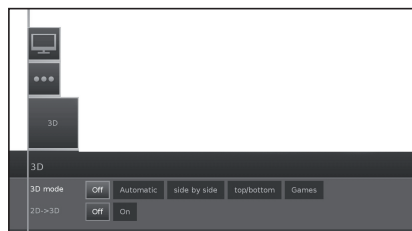

The image signal may contain a 3D identification signal. You can enable the TV to automatically detect the 3D image type.

- After pressing 3D button a screen appears prompting you to select between the following options.
- **When "3D mode" is set to "Automatic"**
The 3D display format is detected automatically and the appropriate 3D image is displayed.



- **When "3D mode" is set to "off"**
The image is displayed as 2D format.

Enjoying 3D image viewing

Receiving a 3D image signal that cannot be detected automatically

When the TV receives a 3D image signal that cannot be detected automatically, you can select between 3D and 2D image viewing.

- 1 Select the 3D source (HDMI).
- 2 Press **3D** button on remote control. The following screen appears.



- 3 Press **◀/▶** to select **"side by side"**, **"top/bottom"** or **"Games"**, and then press **OK**.

● To view in 3D mode ("side by side" or "top-bottom")

- ① Press **◀/▶** to select the 3D signal type ("side by side" or "top/bottom"), and then press **OK**.

- If you select the same system as that of the input signal, 3D images are displayed.

- ② Turn on the 3D glasses switching them to "3D" and then wear the 3D glasses.

- The LED lights up green.

● To view in 2D mode

To view 2D mode without glasses:

- ① Press **▲/▼** to select **"off"**, and then press **OK**.

To view 2D mode some of you at the same time than other people are viewing 3D mode (only with AN-3DG20-B glasses):

- ① Follow up the step ① of previously described in **"To view in 3D mode ("side by side" or "top-bottom")"**.
- ② Turn on the 3D glasses switching to "2D" and then wear the 3D glasses.

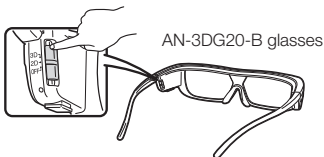

- The LED lights up green.

NOTES

- After approximately 10 minutes without receiving 3D signal the 3D glasses turn off automatically.
- To power off the power of 3D glasses, switch them to Off. The LED will also turn off.

Watching 2D images in 3D

You can convert normal 2D images into 3D images (3D effect).

- 1 Press **3D** button on remote control.
- 2 Press **▲/▼** to select **"2D->3D"→"on"**, and then press **OK**.
- 3 Turn on the power of the 3D glasses, and then wear the 3D glasses.

NOTE

- If the input signal switches to 2D, 2D images are displayed automatically.
- 3D mode is cancelled automatically when: the setting is changed, the input source is changed, the input signal resolution is changed or the power is turned off.



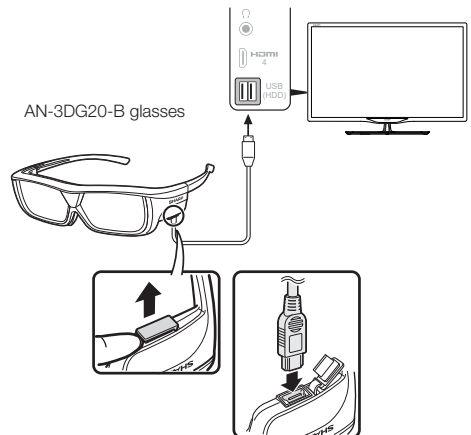

Recharging the 3D glasses battery (AN-3DG20-B glasses)

When the battery power is low, the LED light blinks one time per second. If the 3D glasses battery runs out, you can recharge the 3D glasses battery by connecting the USB-mini USB cable, supplied with glasses, to any of the TV set side USB terminals or any other proper source.

When the LED light goes off, the recharge is complete.

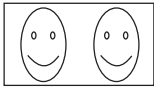

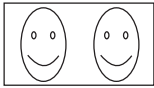
Display format for 3D and 2D images

	Image for input signals	Selectable mode	Description
3D mode (using the 3D glasses)		2D→3D	<ul style="list-style-type: none"> Converts normal 2D images into 3D images.
		Side by Side	<ul style="list-style-type: none"> Creates 3D images from 3D images displayed side by side. The image is split into a left and right image, and then the images are stretched and displayed sequentially to create a 3D image.
		Top and Bottom	<ul style="list-style-type: none"> Creates 3D images from 3D images displayed on the top and bottom. The image is split into a top and bottom image, and then the images are stretched and displayed sequentially to create a 3D image.
2D mode (without using the 3D glasses)		Side by Side → 2D	<ul style="list-style-type: none"> Creates 2D images from 3D images displayed side by side. Only the left image is stretched and displayed. The image does not appear in 3D.
		Top and Bottom → 2D	<ul style="list-style-type: none"> Creates 2D images from 3D images displayed on the top and bottom. Only the top image is stretched and displayed. The image does not appear in 3D.

NOTE

- These 3D glasses are only for use with SHARP LCD TVs supporting 3D.

Troubleshooting - 3D Images

Problem	Possible solution
<ul style="list-style-type: none"> 3D images are not displayed. 	<ul style="list-style-type: none"> Is 3D mode set to "Automatic"? Press 3D to switch to 3D mode "Automatic". If 3D mode is set to "Automatic" but no 3D images are displayed, check the display format of the content being viewed. Some 3D image signals may not be recognised as 3D images automatically. Press 3D to select the appropriate display format for the 3D image. Are the 3D glasses set to 3D mode? Is there an obstacle between the 3D glasses and the TV, or is something covering the infrared receiver on the 3D glasses? The 3D glasses operate by receiving a signal from the TV. Do not place anything between the 3D infrared emitter on the TV and the infrared receiver on the 3D glasses.
<ul style="list-style-type: none"> The 3D glasses turn off automatically. 	<ul style="list-style-type: none"> Is there an obstacle between the 3D glasses and the TV, or is something covering the infrared receiver on the 3D glasses? The 3D glasses turn off automatically after three minutes if no signal is received from the TV. Do not place anything between the 3D infrared emitter on the TV and the infrared receiver on the 3D glasses.
<ul style="list-style-type: none"> Switching the 3D glasses button to 2D or 3D does not cause the LED to light up green. 	<ul style="list-style-type: none"> Is the battery in the 3D glasses exhausted? If the LED light does not light after pressing the power button for more than one second, the battery is exhausted. Recharge the battery via mini USB connector.

Enjoying 3D image viewing

3D glasses lenses

- Do not apply pressure to the lenses of the 3D glasses. Also, do not drop or bend the 3D glasses.
- Do not scratch the surface of the lenses of the 3D glasses with a pointed instrument or other object. Doing so may damage the 3D glasses and reduce the quality of 3D images.
- Use only the cloth provided with the 3D glasses to clean the lenses.

3D glasses infrared receiver

- Do not allow the infrared receiver to become dirty, and do not attach stickers to or otherwise cover the infrared receiver. Doing so may prevent the receiver from operating normally.
- If the 3D glasses are affected by other infrared data communication equipment, 3D images may not be displayed correctly.

Caution during viewing





- Do not use devices that emit strong electromagnetic waves (such as cellular phones or wireless transceivers) near the 3D glasses. Doing so may cause the 3D glasses to malfunction.
- The 3D glasses cannot operate fully at extreme high or low temperatures. Use them within the specified usage temperature range.
- If the 3D glasses are used in a room with fluorescent lighting (50/60 Hz), the light within the room may appear to flicker. In this case, either darken or turn off the fluorescent lights when using the 3D glasses.
- Wear the 3D glasses correctly. 3D images will not be correctly visible if the 3D glasses are worn upside down or back-to-front.
- Other displays (such as computer screens, digital clocks, and calculators) may appear dark and difficult to view while wearing the 3D glasses. Do not wear the 3D glasses when watching anything other than 3D images.
- If you lie on your side while watching the TV with 3D glasses, the picture may look dark or may not be visible.
- Be sure to stay within the viewing angle and optimum TV viewing distance when watching 3D images. Otherwise, you may not be able to enjoy the full 3D effect.
- The 3D glasses may not work properly if there is any other 3D product or electronic device turned on near the glasses or TV. If this occurs, turn off the other 3D product or electronic device or keep the device as far away as possible from the 3D glasses.
- Stop using this product in any of the following situations:
 - When images consistently appear doubled while you are wearing the 3D glasses.
 - When you have difficulty perceiving the 3D effect.
- If the 3D glasses are faulty or damaged, stop using them immediately. Continued use of the 3D glasses may cause eye fatigue, headaches and illness.
- If you have any abnormal skin reaction, stop using the 3D glasses. In very rare instances, such reactions may be due to an allergic reaction to the coating or materials used.
- If your nose or temples become red or you experience any pain or itchiness, stop using the 3D glasses. Pressure caused by long periods of use may lead to such reactions and may result in skin irritation.
- You may not be able to use several menu items while you are watching the TV in 3D mode.
- You cannot use the 3D function in radio or data mode.

DISCLAIMERS

- This Sharp device facilitates the access to content and services provided by third parties. The content and services accessible via this device belong to and may be proprietary to third parties. Therefore, any use of such third party content and services must be in accordance with any authorisation or terms of use provided by such content or service provider. Sharp shall not be liable to you or any third party for your failure to abide by such authorisation or terms of use. Unless otherwise specifically authorised by the applicable content or service provider, all third party content and services provided are for personal and non-commercial use; you may not modify, copy, distribute, transmit, display, perform, reproduce, upload, publish, license, create derivative works from, transfer or sell in any manner or medium any content or services available via this device.
- Sharp is not responsible, nor liable, for customer service-related issues related to the third party content or services. Any questions, comments or service-related inquiries relating to the third party content or service should be made directly to the applicable content or service provider.
- You may not be able to access content or services from the device for a variety of reasons which may be unrelated to the device itself, including, but not limited to, power failure, other Internet connection, or failure to configure your device properly. Sharp, its directors, officers, employees, agents, contractors and affiliates shall not be liable to you or any third party with respect to such failures or maintenance outages, regardless of cause or whether or not it could have been avoided.
- ALL THIRD PARTY CONTENT OR SERVICES ACCESSIBLE VIA THIS DEVICE IS PROVIDED TO YOU ON AN "AS-IS" AND "AS AVAILABLE" BASIS AND SHARP AND ITS AFFILIATES MAKE NO WARRANTY OR REPRESENTATION OF ANY KIND TO YOU, EITHER EXPRESS OR IMPLIED, INCLUDING, WITHOUT LIMITATION, ANY WARRANTIES OF MERCHANTABILITY, NON-INFRINGEMENT, FITNESS FOR A PARTICULAR PURPOSE OR ANY WARRANTIES OF SUITABILITY, AVAILABILITY, ACCURACY, COMPLETENESS, SECURITY, TITLE, USEFULNESS, LACK OF NEGLIGENCE OR ERROR-FREE OR UNINTERRUPTED OPERATION OR USE OF THE CONTENT OR SERVICES PROVIDED TO YOU OR THAT THE CONTENT OR SERVICES WILL MEET YOUR REQUIREMENTS OR EXPECTATIONS.
- SHARP IS NOT AN AGENT OF AND ASSUMES NO RESPONSIBILITY FOR THE ACTS OR OMISSIONS OF THIRD PARTY CONTENT OR SERVICE PROVIDERS, NOR ANY ASPECT OF THE CONTENT OR SERVICE RELATED TO SUCH THIRD PARTY PROVIDERS.
- IN NO EVENT WILL SHARP AND/OR ITS AFFILIATES BE LIABLE TO YOU OR ANY THIRD PARTY FOR ANY DIRECT, INDIRECT, SPECIAL, INCIDENTAL, PUNITIVE, CONSEQUENTIAL OR OTHER DAMAGES, WHETHER THE THEORY OF LIABILITY IS BASED ON CONTRACT, TORT, NEGLIGENCE, BREACH OF WARRANTY, STRICT LIABILITY OR OTHERWISE AND WHETHER OR NOT SHARP AND/OR ITS AFFILIATES HAVE BEEN ADVISED OF THE POSSIBILITY OF SUCH DAMAGES.

Appendix

Troubleshooting

Problem	Possible Solution
• No power.	<ul style="list-style-type: none"> • Check if you pressed  on the remote control unit. If the indicator on the TV lights up red, press . • Is the AC cord disconnected? • Check if you pressed  on the TV.
• The TV cannot be operated.	<ul style="list-style-type: none"> • External influences such as lightning, static electricity, etc., may cause improper operation. In this case, operate the TV after first turning off the power, or unplugging the AC cord and re-plugging it in after one or two minutes.
• Remote control unit does not operate.	<ul style="list-style-type: none"> • Are batteries inserted with polarity (+, -) aligned? • Are batteries worn out? (Replace with new batteries.) • Are you using it under strong or fluorescent lighting? • Is a fluorescent light illuminating the remote control sensor?
• Picture is cut off.	<ul style="list-style-type: none"> • Is the image position correct? • Are screen mode adjustments (Picture format) such as picture size made correctly? (Page 31.)
• Strange colour, light colour, or dark colour, or colour misalignment.	<ul style="list-style-type: none"> • Adjust the picture tone. • Is the room too bright? The picture may look dark in a room that is too bright. • Check the "Picture" settings (Page 21).
• Power is suddenly turned off.	<ul style="list-style-type: none"> • The TV's internal temperature has increased. Clean or remove any objects blocking the vent.
• No picture.	<ul style="list-style-type: none"> • Are connections to external equipment correct? (Pages 41, 42 and 43) • Is the input signal type selected correctly after connection? (Page 14) • Is the correct input source selected? (Page 31) • Is the picture adjustment correct? (Pages 21) • Is the antenna connected properly? (Pages 7 and 14)
• No sound.	<ul style="list-style-type: none"> • Is the volume too low? • Make sure that headphones are not connected. • Check if you pressed  on the remote control unit.
• The TV sometimes makes a cracking sound.	<ul style="list-style-type: none"> • This is not a malfunction. This happens when the cabinet slightly expands and contracts according to changes in temperature. This does not affect the TV's performance.

Information on the software license for this product

Software composition

The software included in this product is comprised of various software components whose individual copyrights are held by SHARP or by third parties.

Software developed by SHARP and/or third part

The copyrights for the software components and various relevant documents included with this product that were developed or written by SHARP are owned by SHARP and are protected by the Copyright Act, international treaties, and other relevant laws. This product also makes use of freely distributed software and software components whose copyrights are held by third parties.

Environmental Specifications

	39"	50"	60"
*1 On-Mode (W) (HOME MODE)	45 W	70 W	100 W
*2 Standby-Mode (W)	0.24 W	0.24 W	0.24 W
*3 Off Mode (W)	0.16 W	0.16 W	0.16 W
*4 Annual Energy Consumption (kWh)	66 kWh	102 kWh	146 kWh
5 Energy Efficiency Class	A+	A+	A+

*1 Measured according to IEC 62087 Ed. 2.

*2 Measured according to IEC 62301 Ed. 1.

*3 Measured according to IEC 62301 Ed. 1.

*4 Annual energy consumption is calculated on the basis of the On-Mode (HOME MODE) power consumption, watching TV 4 hours a day, 365 days a year.

EC Declaration of Conformity for AN-WUD630 dongle

Hereby, SHARP Electronics (Europe) GmbH declares that the wireless LAN USB adapter (AN-WUD630) is in compliance with the essential requirements and other relevant provisions of Directive 1999/5/EC. The declaration of conformity may be consulted at: <http://www.sharp.de/doc/AN-WUD630.pdf>

Important note

As a part of our policy of continuous improvement, SHARP reserves the right to make design and specification changes for product improvement without prior notice. The performance specification figures indicated are nominal values of production units. There may be some deviations from these values in individual units.

Appendix

Specifications

Item		39" LCD COLOUR TV, Models: LC-39LE650E/RU/V LC-39LE651E/K/RU/V LC-39LE652E/RU/V LC-39LE654E/RU/V LC-39LU651E LC-39LM652E/V LC-39LK652E LC-39LX652E	50" LCD COLOUR TV, Models: LC-50LE650E/RU/V LC-50LE651E/K/RU/V LC-50LE652E/RU/V LC-50LE654E/RU/V LC-50LU651E LC-50LM652E/V LC-50LK652E LC-50LX652E	60" LCD COLOUR TV, Models: LC-60LE650E/RU LC-60LE651E/K/RU LC-60LE652E/RU LC-60LE654E/RU LC-60LU651E LC-60LM652E LC-60LK652E LC-60LX652E	
LCD Panel (LED TV)		39"/ 98cm BLACK TFT	50"/ 126cm BLACK TFT	60"/ 152cm BLACK TFT	
Resolution		6.220.800 dots (1.920 x 1.080 pixels)			
Video Colour System		PAL/SECAM/NTSC 3.58/NTSC 4.43/PAL 60			
TV Functions	TV Standard	Analogue	CCIR (B/G, I, D/K, L/L')		
		Digital	DVB-T (2K/8K OFDM)(H.264), DVB-C, DVB-C2 (L*654 only), DVB-T2(L*651/654 only), DVB-S/S2 (L*652/654 only)		
	Receiving Channel	VHF/UHF	E2–E69 ch, F2–F10 ch, I21–I69 ch, IR A–IR J ch (Digital: IR A ch–E69 ch)		
		CATV	Hyper-band, S1–S41 ch		
	TV-Tuning System	Auto Preset 999 ch: non-Nordic / 9999 ch: Nordic (ATV: 99 ch), Auto Label, Auto Sort			
STEREO / BILINGUAL		NICAM/A2			
Viewing angles		H: 176°, V: 176°			
Audio Amplifier		15 W + 15 W (Music power)			
Speaker		(96 mm x 30mm) x 2			
Terminals	TV Antenna	VHF/UHF	UHF/VHF 75 Ω Din type (Analogue & Digital)		
		Satellite (652/654 series only)	75 Ω F type (DVB-S/S2)		
	SERVICE		Ø 3.5 mm jack		
	SCART		SCART (AV input, RGB input, TV output, Y/C input)		
	PC INPUT		VGA (D-Sub 15pin), Ø 3.5 mm jack (shared with HDMI)		
	COMPONENTS		COMPONENT IN: Y/PB(CB)/PR(CR), RCA (AUDIO R/L)		
	HDMI1		HDMI, Ø 3.5 mm jack (shared with PC INPUT), ARC, 3D.		
	HDMI2		HDMI, Ø 3.5 mm jack (shared with PC INPUT), 3D.		
	HDMI3		HDMI, Ø 3.5 mm jack (shared with PC INPUT), 3D.		
	HDMI4		HDMI, Ø 3.5 mm jack (shared with PC INPUT), 3D.		
	USB 1		USB 2.0 HOST (A Type)		
	USB 2		USB 2.0 HOST (A type)		
	USB 3 (WIFI)		USB 2.0 HOST (A type) (Wi-Fi use only)		
	ETHERNET (10/100)		Network connector		
	AV		RCA connector (AV input)		
S/PDIF OUT		RCA S/PDIF digital audio output.			
C. I. (Common Interface)		EN50221, R206001, CI+ specification			
Headphones		Ø 3.5 mm jack (Audio output)			
OSD language		Czech, Danish, Dutch, English, Estonian, Finnish, French, German, Greek, Hungarian, Italian, Latvian, Lithuanian, Norwegian, Polish, Portuguese, Russian, Slovak, Slovene, Spanish, Swedish, Turkish, Ukrainian, Byelorussian, Romanian, Croatian, Serbian.			
Power Requirement		AC 220–240 V, 50 Hz			
Power Consumption (IEC62087 Method)		99W (0.24W Stby)	121W (0.24W Stby)	175W (0.24W Stby)	
Weight		10.7Kg (Without stand) 13.3 Kg (With stand)	16.7Kg (Without stand) 20.1Kg (With stand)	24.3Kg (Without stand) 30.7 Kg (With stand)	
Operating Temperature		0 °C to +40 °C			

End of life disposal



Attention: Your product is marked with this symbol. It means that used electrical and electronic products should not be mixed with general household waste. There is a separate collection system for these products.

A. Information on Disposal for Users (private households)

1. In the European Union

Attention: If you want to dispose of this equipment, please do not use the ordinary dust bin!

Used electrical and electronic equipment must be treated separately and in accordance with legislation that requires proper treatment, recovery and recycling of used electrical and electronic equipment.

Following the implementation by member states, private households within the EU states may return their used electrical and electronic equipment to designated collection facilities free of charge*. In some countries* your local retailer may also take back your old product free of charge if you purchase a similar new one.

*) Please contact your local authority for further details.

If your used electrical or electronic equipment has batteries or accumulators, please dispose of these separately beforehand according to local requirements.

By disposing of this product correctly you will help ensure that the waste undergoes the necessary treatment, recovery and recycling and thus prevent potential negative effects on the environment and human health which could otherwise arise due to inappropriate waste handling.

2. In other Countries outside the EU

If you wish to discard this product, please contact your local authorities and ask for the correct method of disposal.

For Switzerland: Used electrical or electronic equipment can be returned free of charge to the dealer, even if you don't purchase a new product. Further collection facilities are listed on the homepage of www.swico.ch or www.sens.ch.

B. Information on Disposal for Business Users

1. In the European Union

If the product is used for business purposes and you want to discard it:

Please contact your SHARP dealer who will inform you about the take-back of the product. You might be charged for the costs arising from take-back and recycling. Small products (and small amounts) might be taken back by your local collection facilities.

For Spain: Please contact the established collection system or your local authority for take-back of your used products.

2. In other Countries outside the EU

If you wish to discard of this product, please contact your local authorities and ask for the correct method of disposal.



Pb

The battery supplied with this product contains traces of Lead.

For EU: The crossed-out wheeled bin implies that used batteries should not be put to the general household waste! There is a separate collection system for used batteries, to allow proper treatment and recycling in accordance with legislation. Please contact your local authority for details on the collection and recycling schemes.

For Switzerland: The used battery is to be returned to the selling point.

For other non-EU countries: Please contact your local authority for correct method of disposal of the used battery.

Trademarks

• "HDMI, the HDMI logo and High-Definition Multimedia Interface are trademarks or registered trademarks of HDMI Licensing LLC."

- Manufactured under license from Dolby Laboratories.
- "Dolby" and the double-D symbol are trademarks of Dolby Laboratories.

• The "HD TV 1080p" Logo is trademark of DIGITALEUROPE.

• The DVB logo is the registered trademark of the Digital Video Broadcasting—DVB—project.

• DivX®, DivX Certified® and associated logos are trademarks of Rovi Corporation or its subsidiaries and are used under license.

• The "CI Plus" Logo is a trademark of CI Plus LLP.

• DLNA®, the DLNA Logo and DLNA CERTIFIED™ are trademarks, service marks, or certification marks of the Digital Living Network Alliance.

• All other company or product names are trademarks or registered trademarks of their respective companies.

LC-39LE650E/V
 LC-39LE651E/K/V
 LC-39LU651E
 LC-39LE652E/V
 LC-39LM652E/V
 LC-39LK652E
 LC-39LX652E
 LC-39LE654E/V

LC-50LE650E/V
 LC-50LE651E/K/V
 LC-50LU651E
 LC-50LE652E/V
 LC-50LM652E
 LC-50LK652E
 LC-50LX652E
 LC-50LE654E/V

LC-60LE651E/K
 LC-60LU651E
 LC-60LE652E
 LC-60LM652E
 LC-60LK652E
 LC-60LX652E
 LC-60LE654E

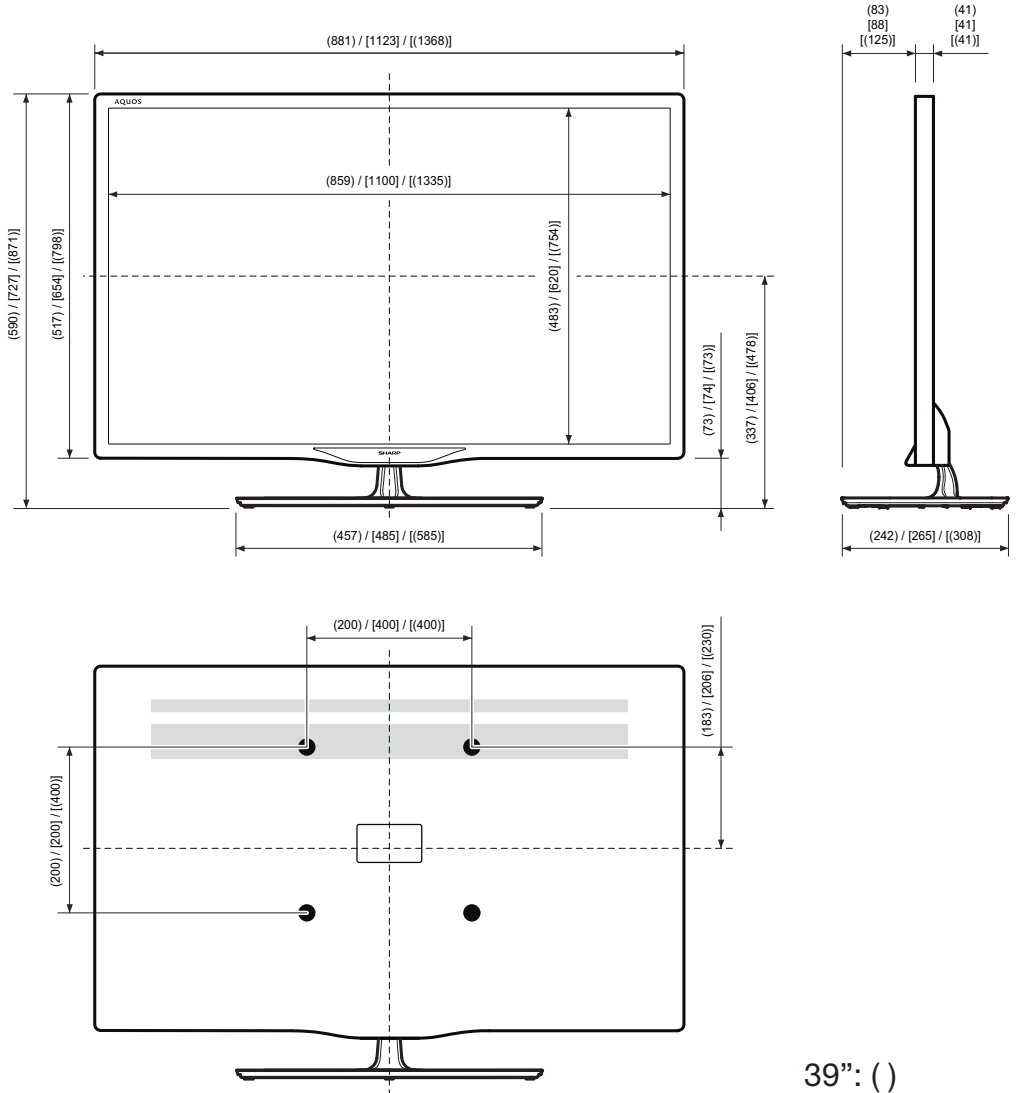

39": ()
 50": []
 60": [()]

SHARP®

SHARP CORPORATION

<http://www.sharp.eu>

Sharp Electronics Europe Ltd.
4 Furzeground Way, Stockley Park
Uxbridge, Middlesex, UB11 1EZ, UK

Printed in Poland
Gedruckt in Polen
Imprimé en Pologne
Stampato in Polonia
Gedruckt in Polen
Impreso en Polonia
Impreso na Polónia



TINS-F675WJN1

13P09-PL-NG

PIN

--	--	--	--