



GLEN DIMPLEX
HOME APPLIANCES

Warming Drawer
User Guide
GDHA UWD14 Blk/Sta

Warning and Safety instructions 2

Caring for the environment 4

Before using for the first time 4

Guide to the appliance 5

Control panel 6

Operation 6

Function 6

Temperature settings 7

Duration 7

Capacity 7

Keeping food warm 8

Low temperature cooking 9

Other uses 16

Cleaning and care 17

Problem solving guide 19

Safety instructions for installation 21

Building-in dimensions 22

Technical data 23

Environmental protection

Warning and Safety instructions

This appliance complies with all relevant safety requirements. Inappropriate use can, however, lead to personal injury and damage to property.

To avoid the risk of accidents and damage to the appliance, please read these instructions carefully before installation and before using it for the first time. They contain important notes on installation, safety, use and maintenance.

Keep these instructions in a safe place and ensure that new users are familiar with the content. Pass them on to any future owner.

Warning and Safety instructions

Correct application

- ▶ The appliance is not designed for commercial use. It is intended for use in domestic households and similar working and residential environments.
- ▶ The appliance is not intended for outdoor use.
- ▶ It is intended for domestic use only as described in these operating and installation instructions. Any other usage is not supported by the manufacturer and could be dangerous.
- ▶ The appliance can only be used by people with reduced physical, sensory or mental capabilities, or lack of experience and knowledge, if they are supervised whilst using it, or have been shown how to use it in a safe way and understand the hazards involved.

Safety with children

- ▶ Children under 8 years of age must be kept away from the appliance unless they are constantly supervised.
- ▶ Children 8 years and older may only use the appliance if they have been shown how to use it in a safe way and understand the hazards involved.
- ▶ Children must not be allowed to clean the appliance unsupervised.
- ▶ This appliance is not a toy! To avoid the risk of injury, do not let children play with the appliance or its controls.
- ▶ The appliance gets hot when in use and remains hot for quite a while after being switched off. Keep children well away from the appliance until it has cooled down and there is no danger of burning.

- ▶ Packaging, e.g. cling film, polystyrene and plastic wrappings, must be kept out of the reach of babies and children. Danger of suffocation. Dispose of or recycle all packaging safely as soon as possible.

Technical safety

- ▶ Installation, maintenance and repair work may only be carried out by a suitably qualified and competent person in strict accordance with national and local safety regulations. Installation, maintenance and repairs by unqualified persons could be dangerous.

- ▶ A damaged appliance can be dangerous. Before installation, check the appliance for visible signs of damage. Do not use a damaged appliance.

- ▶ The electrical safety of this appliance can only be guaranteed when correctly earthed. It is most important that this basic safety requirement is observed and regularly tested, and where there is any doubt, the household wiring system should be inspected by a qualified electrician.

- ▶ To avoid the risk of damage to the appliance, make sure that the connection data (frequency and voltage) on the data plate corresponds to the household supply, before connecting the appliance to the mains supply. Consult a qualified electrician if in any doubt.

- ▶ Do not connect the appliance to the mains electricity supply by a multi-socket adapter or an extension lead. These do not guarantee the required safety of the appliance (e.g. danger of overheating).

- ▶ For safety reasons, this appliance may only be used when it has been built in.

This appliance must not be used in a non-stationary location (e.g. on a ship).

- ▶ Do not open the casing of the appliance. Tampering with electrical connections or components and mechanical parts is highly dangerous to the user and can cause operational faults.

- ▶ While the appliance is under guarantee, repairs should only be undertaken by a service technician. Otherwise the guarantee is invalidated.

- ▶ The manufacturer can only guarantee the safety of the appliance when replacement parts are used. Faulty components must only be replaced by genuine original spare parts.

- ▶ If the plug is removed from the connection cable or if the appliance is supplied without a plug, the appliance must be connected to the electrical supply by a suitably qualified electrician.

- ▶ The appliance must be disconnected from the mains electricity supply during installation, maintenance and repair work. Ensure that power is not supplied to the appliance until after it has been installed or until any maintenance or repair work has been carried out.

- ▶ In areas which may be subject to infestation by cockroaches or other vermin, pay particular attention to keeping the appliance and its surroundings in a clean condition at all times. Any damage which may be caused by cockroaches or other vermin will not be covered by the guarantee.

Correct use

- ▶ THE DRAWER IS DESIGNED TO KEEP HOT FOOD WARM AND NOT TO WARM FOOD UP. ENSURE FOOD IS REALLY HOT WHEN PLACED INSIDE THE WARMING DRAWER.

- ▶ You could burn yourself on the hot drawer or crockery. Protect your hands with heat-resistant pot holders or gloves when using the appliance. Do not let them get wet or damp, as this causes heat to transfer through the material more quickly with the risk of scalding or burning yourself.

- ▶ Do not store any plastic containers or flammable objects in the warming drawer. They could melt or catch fire when the appliance is switched on, causing a fire hazard.

- ▶ Due to the high temperatures radiated, objects left near the appliance when it is in use could catch fire. Do not use the appliance to heat up the room.

- ▶ Never replace the anti-slip mat supplied with the appliance with paper kitchen towel or similar.

- ▶ If you overload the drawer, or sit or lean on it, the telescopic runners will be damaged. The telescopic runners can support a maximum load of 25 kg.

- ▶ If the appliance is installed behind a kitchen furniture door, it may only be used with the furniture door open. Only close the door if the appliance is switched off.

- ▶ Do not heat up unopened tins or jars of food in the drawer, as pressure will build up in the tin or jar causing it to explode. This could result in injury and scalding or damage.
- ▶ The underside of the drawer gets hot when switched on. Be careful not to touch it when the drawer is open.
- ▶ Do not use plastic or aluminium containers. These melt at high temperatures and could catch fire. Use only heat-resistant crockery made of glass, porcelain, etc.

- ▶ Take care when opening and closing the loaded drawer, that liquids do not spill over and get through the vents. This can cause the appliance to short circuit.
- ▶ Bacteria can develop on the food if the temperature is too low. Make sure that you set a high enough temperature to keep food warm.

Cleaning and care

- ▶ Danger of injury.
Do not use a steam cleaning appliance to clean this appliance. The steam could reach electrical components and cause a short circuit.

Caring for the environment

Disposal of the packing material

The transport and protective packing has been selected from materials which are environmentally friendly for disposal, and should be recycled.

Ensure that any plastic wrappings, bags, etc. are disposed of safely and kept out of the reach of babies and young children. Danger of suffocation.

Disposal of your old appliance

Electrical and electronic appliances often contain materials which, if handled or disposed of incorrectly, could be potentially hazardous to human health and to the environment. They are, however, essential for the correct functioning of your appliance.

Please do not therefore dispose of it with your household waste.

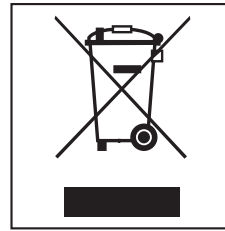

Please dispose of it at your local community waste collection/recycling centre or contact your dealer for advice. Please ensure that it presents no danger to children while being stored for disposal.

Before using for the first time

A display test is carried out for 10 seconds after the appliance has been installed and after a power cut. The fan comes on at the same time. The appliance cannot be used during this time.





Please stick the extra data plate for the appliance supplied with this documentation in the space provided in the "After sales service, data plate" section of this booklet.

Cleaning and heating up for the first time

- Remove any protective foil and sticky labels.
- Remove the anti-slip mat and, if applicable, the rack from the drawer, and sponge both with warm water and a little washing-up liquid. Dry using a soft cloth.

- Wipe the appliance inside and out with a damp cloth only, and then dry with a soft cloth.
- Replace the anti-slip mat and the rack (if applicable) in the drawer.

Then heat the empty drawer for at least two hours.

- Switch the appliance on by touching the  sensor.
- Touch the  sensor repeatedly until the LED light.
- Touch the  sensor repeatedly until the LED on the far right lights up.
- Touch the  sensor repeatedly until 2h lights up.

■ Close the drawer.

The warming drawer is fitted with a softclose self-closing mechanism.

It also has a contact switch, which ensures that the heating element and fan in the appliance only work when the drawer is closed.

Metal components have a protective coating which may give off a slight smell when heated up for the first time.

The smell and any vapours will dissipate after a short time, and do not indicate a faulty connection or appliance. Ensure that the kitchen is well ventilated whilst the appliance is being heated up for the first time.

Guide to the appliance

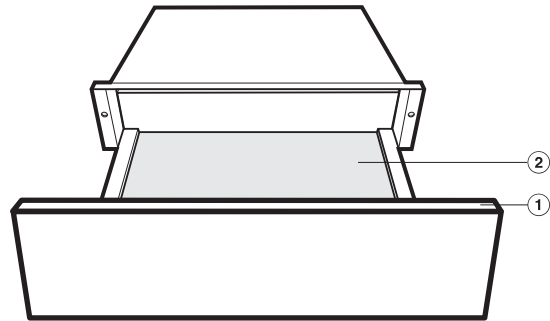
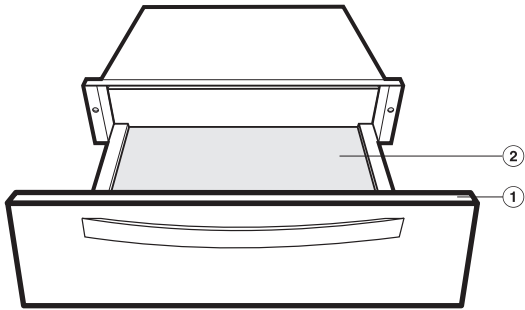

① Control panel

② Anti-slip mat :For keeping crockery secure(Optional accessories)

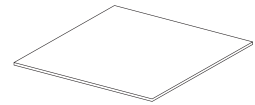

For appliances with no handle: Press the middle of the drawer to open or close it. When opening, the drawer pops out slightly. You can then pull it out towards you.

CONTROL PANEL



 For warming cups and glasses

 For warming plates and dishes

 For keeping food warm

 For setting the temperature

 For setting the duration

 For adjust temperature and time

 Cancel Button







 Start Button

The appliance can be used to keep food warm at the same time as warming plates and dishes. But the food must be covered properly and dry the dishes when finished.







Take care. The plates and dishes will take longer to warm up, but can get very hot on this function.



Operation

Function settings

- (1) In waiting state, press " key to start the function of warming cups and glasses with 40°C.
- (2) "40°C" will display.
- (3) Touch " " or " " to adjust the temperature.
- (4) Touch " " and then touch " " or " " to adjust the warming time.
- (5) Touch " " to save the temperature and time.
- (5) Close the door and there will be a beep. Then the appliance will start working.

Note:

- (1) During parameters setting, you can press other function keys to change the function among "", " " and "".
- (2) Before closing the door, you can touch " " to cancel the setting. And the appliance will go back to waiting state.
- (3) During the process of working, open the door to enter to the parameters adjusting mode. And then press " " or " " to adjust the temperature.

You can press the " " or " " to change the parameter which you want to adjust. And then press " " to save the setting.



(4) After saving the setting as above, you can press " " to enter to the waiting state, or close the door to start working.

Specifications

- (1) When the appliance is electrified, open the door. The buzzer will ring once and the appliance will enter to waiting state. "0" will display.
- (2) In the process of clock setting, if there is no operation within 3 minute, the oven will go back to the waiting state.
- (3) The buzzer sounds once by efficient press.
- (4) The buzzer will sound thrice to remind you when cooking is finished.

Temperature settings

Each function has its own temperature range. The factory-set recommended temperatures are printed in bold. The temperature can be altered in 5° steps by touching the  sensor. The last temperature selected is automatically activated the next time the drawer is switched on, and this is shown in the display.

Temperature °C*		
		
40	60	60
45	65	65
50	70	70
55	75	75
60	80	80

* Approximate temperature values, measured in the middle of the drawer when empty

Duration

The appliance is set for continuous operation mode. A limited duration can be selected by touching the  sensor. One touch for 1 hour (1h), two touches for 2 hours (2h) etc.

Capacity

The quantity that can be loaded will depend to a great extent on the size and weight of your own crockery. Do not overload the drawer. The maximum load bearing capacity of the drawer is 25 kg. Under the maximum load bearing capacity, the drawer should be opened or closed slightly.

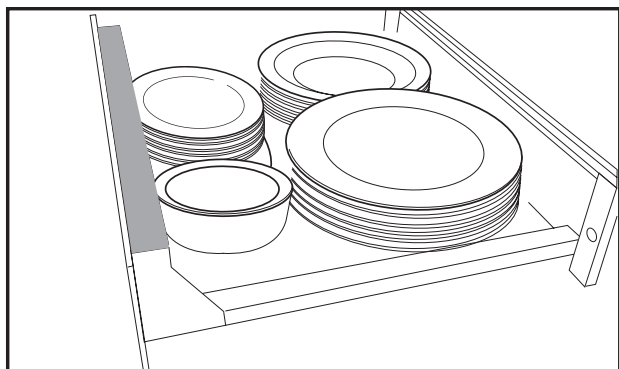

The loading examples shown here are suggestions only.

- preheat dinnerware for people:
 - 6 dinner plates Ø 26 cm
 - 6 soup plates Ø 23 cm
 - 6 dessert dishes Ø 19 cm
 - 1 oval platter 32cm
 - 1 medium serving bowl Ø 16cm
 - 1 small serving bowl Ø 13 cm

Keeping food warm

Settings

Food	Cover the container?	Temperature for the  setting
Steak (rare)	yes	65
Bake/gratin	yes	80
Roast meat	yes	75
Casserole	yes	80
Fish fingers	no	80
Meat in a sauce	yes	80
Vegetables in a sauce	yes	80
Goulash	yes	80
Mashed potato	yes	75
Plated meal	yes	80
Baked potatoes / New potatoes	yes	75
Breaded escalope	no	80
Pancakes/ potato pancakes	no	80
Pizza	no	80
Boiled potatoes	yes	80
Gravy	yes	80
Strudel	no	80
To warm bread	no	65
To warm rolls	no	65

* Depending on model

* The containers depend on the quantity, or food, or type of recipe

Low temperature cooking

What it is?

It is any cooking procedure where the cooking temperature is at or close to the desired final core temp. In traditional cooking, the cooking temperature always exceeds the desired ready-to-eat temperatures. With low temperature cooking meat cooks at a low temperature over a long period of time. Using this method, meat loses less liquid (less molecule breaking), maintain organoleptic characteristic (vitamins, proteins and so on) keeping Freshness, flavor and juiciness intact.

This cooking method is particularly suitable for large and tender pieces of meat.

For precision we recommend using a proprietary food thermometer to monitor the core temperature.

Core temperature

Food can be cooked to a core temperature of up to 70 °C in the food warming drawer. Meat which needs to be cooked to a core temperature higher than 70 °C is not suitable for cooking in the food warming drawer.

The core temperature reading gives information about the degree of cooking in the middle of a piece of meat. The lower the core temperature, the less cooked the meat is in the middle:

45-50 °C = rare

55-60 °C = medium

65 °C = well done

How to use it

1. Preheat the hot cabinet for 15 min to 70 °C.
2. Cover the meat properly with cling wrap.
3. The cooking duration depends on the size of the individual pieces of meat (check table)

Low temperature cooking

4. Put the covered meat on a plate and use a chronometer to calculate the time.

5. Sear the meat to give flavour (check the table)

Low temperature cooking

Cooking table

Beef and Veal				
Part	Thickness	Doneness	Time	Searing time and indications
Whole Fillet	50 mm	Rare	1h 35min	90 seconds for outer side with full power of the stove
		Medium	2h 35min	
		Well done	3h 30min	3 min. for outer side with medium-high power of the stove
	60 mm	Rare	1h 45min	90 seconds for outer side with full power of the stove
		Medium	2h 50min	
		Well done	4h	3 min. for outer side with medium-high power of the stove
	70 mm	Rare	2h	90 seconds for outer side with full power of the stove
		Medium	3h	
		Well done	4h 40min	3 min. for outer side with medium-high power of the stove
Medallions Rib eye T-bone Rump Steak	20 mm	Rare	50 min	90 seconds for side with full power of the stove
		Medium	1h 30min	
		Well done	2h	3 min. for side with medium-high power of the stove
	30 mm	Rare	1h 5min	90 seconds for side with full power of the stove
		Medium	1h 50min	
		Well done	2h 20min	3 min. for side with medium-high power of the stove
	40 mm	Rare	1h 20min	2 min for side with full power of the stove
		Medium	2h 10min	
Well done		3h	4 min. for side with medium-high power of the stove	
Sirloin joint Roast Beef	60 mm	Rare	1h 45min	4 min. for outer side with medium-high power of the stove
		Medium	2h 50min	
	70 mm	Well done	4h	6 min. for outer side with medium power of the stove
		Rare	2h	4 min. for outer side with medium-high power of the stove
	80 mm	Medium	3h	
		Well done	4h 40min	6 min. for outer side with medium power of the stove
80 mm	Rare	2h 20min	4 min. for outer side with medium-high power of the stove	
	Medium	3h 30min		
	Well done	5h 40min	4 min. for outer side with medium-high power of the stove	
			6 min. for outer side with medium power of the stove	

Low temperature cooking

Pork					
Part	Thickness	Doneness	Time	Searing time and indications	
Whole filet	40mm	Medium	2h 20min	90 seconds for outer side with full power of the stove	
		Well done	3h 10min	3 min. for outer side with medium-high power of the stove	
	50mm	Medium	2h 35min	90 seconds for outer side with full power of the stove	
		Well done	3h 25min	3 min. for outer side with medium-high power of the stove	
	60mm	Medium	3h	90 seconds for outer side with full power of the stove	
		Well done	4h 5min	3 min. for outer side with medium-high power of the stove	
Boned gammon Roulades Roast pork Whole pork loin	30mm	Medium	1h 50min	2 min. for outer side with high power of the stove	
		Well done	2h 40min	3 min. for outer side with medium-high power of the stove	
	40mm	Medium	2h 20min	2 min. for outer side with high power of the stove	
		Well done	3h 10min	3 min. for outer side with medium-high power of the stove	
	50mm	Medium	2h 35min	4 min. for outer side with medium-high power of the stove	
		Well done	3h 25min	6 min. for outer side with medium power of the stove	
	60mm	Medium	3h	4 min. for outer side with medium-high power of the stove	
		Well done	4h 5min	6 min. for outer side with medium power of the stove	
	70mm	Medium	3h 20min	4 min. for outer side with medium-high power of the stove	
		Well done	4h 45min	6 min. for outer side with medium power of the stove	
	80mm	Medium	3h 40min	4 min. for outer side with medium-high power of the stove	
		Well done	5h 30min	6 min. for outer side with medium power of the stove	
	Chop loin	10mm	Medium	1h 10min	60 seconds for side with full power of the stove
			Well done	1h 30min	2 min. for side with full power of the stove
20mm		Medium	1h 30min	90 seconds for side with full power of the stove	
		Well done	2h 10min	3 min. for side with high power of the stove	

Low temperature cooking

Poultry				
Part	Thickness	Doneness	Time	Searing time and indications
Chicken breast	25mm	Medium	1h 30min	60 seconds for side with full power of the stove
		Well done	2h	90 seconds for side with full power of the stove
	35mm	Medium	1h 45min	60 seconds for side with full power of the stove
		Well done	2h 20min	90 seconds for side with high power of the stove
Duck breast (Magret)	35mm	Rare	1h	4 min. for the skin side with medium-high power of the stove
		Medium	1h 30min	4 min. for the skin side with medium-high power of the stove
		Well done	2h	4 min. for the skin side with medium-high power of the stove
	40mm	Rare	1h 45min	4 min. for the skin side with medium-high power of the stove
		Medium	2h 20min	4 min. for the skin side with medium-high power of the stove
		Well done	3h	4 min. for the skin side with medium-high power of the stove
Turkey breast	40mm	Medium	3h	90 seconds for side with full power of the stove
		Well done	4h	3 min. for side with high power of the stove
	50mm	Medium	3h 50min	90 seconds for side with full power of the stove
		Well done	5h	3 min. for side with high power of the stove
Foie Medallion (Duck or Goose liver)	10mm	Medium	30min	60 seconds for side with full power of the stove
	20mm	Medium	40min	60 seconds for side with full power of the stove
	30mm	Medium	50min	60 seconds for side with full power of the stove
Whole Foie (Duck or Goose liver)	35mm	Medium	48min	90 seconds for outer side with full power of the stove
	45mm	Medium	1h	90 seconds for outer side with full power of the stove
	55mm	Medium	1h 15min	90 seconds for outer side with full power of the stove

Low temperature cooking

Lamb				
Part	Thickness	Doneness	Time/Temp.	Searing time and indications
Rack of lamb	40 mm	Rare	1h 20min	90 seconds for outer side with full power of the stove.
		Medium	2h 10min	
		Well done	3h	3 min. for outer side with medium-high power of the stove.
	50 mm	Rare	1h 35min	90 seconds for outer side with full power of the stove.
		Medium	2h 35min	
	Well done	3h 30min	3 min. for outer side with medium-high power of the stove.	
60 mm	Rare	1h 45min	90 seconds for outer side with full power of the stove.	
	Medium	2h 50min		
Well done	4h	3 min. for outer side with medium-high power of the stove.		
Saddle of Lamb	60 mm	Rare	1h 45min	3 min for outer side with full power of the stove.
		Medium	2h 50min	
		Well done	4h	4 min. for outer side with medium-high power of the stove.
	70 mm	Rare	2h	3 min for outer side with full power of the stove.
		Medium	3h	
	Well done	4h 40min	4 min. for outer side with medium-high power of the stove.	
80 mm	Rare	2h 20min	3 min for outer side with full power of the stove.	
	Medium	3h 30min		
Well done	5h 40min	4 min. for outer side with medium-high power of the stove.		
Boned leg of lamb Gigot	60 mm	Rare	1h 45min	2 min for outer side with full power of the stove.
		Medium	2h 50min	
		Well done	4h	3 min. for outer side with medium-high power of the stove.
	70 mm	Rare	2h	2 min for outer side with full power of the stove.
		Medium	3h	
	Well done	4h 40min	3 min. for outer side with medium-high power of the stove.	
80 mm	Rare	2h 20min	2 min for outer side with full power of the stove.	
	Medium	3h 30min		
Well done	5h 40min	3 min. for outer side with medium-high power of the stove.		
Lamb chops	10 mm	Rare	35min	60 seconds for side with full power of the stove.
		Medium	1h 10min	
	Well done	2h	90 seconds for side with full power of the stove.	
	20 mm	Rare	50min	60 seconds for side with full power of the stove.
Medium		1h 30min		
Well done	2h 30min	90 seconds for side with full power of the stove.		

Low temperature cooking

Eggs		
Size	Weight	Time
Very Large	73g and over	2h 20min
		2h 30min
		3h 10min
Large	63g < 73g	2h 11min
		2h 31min
		3h 1min
Medium	53g < 63g	2h 5min
		2h 25min
		2h 55min
Small	53 and under	2h
		2h 20min
		2h 50min

Other uses

Type of food	Container	Cover the container	Temperature of the setting	Duration in hours
Defrosting berries	Plate	no	65°C	1 hour
Defrosting Frozen Vegetables	Plate	no	65°C	1 hour
Proving dough	Bowl	yes	45°C	1/2 hour
Making yoghurt	Yoghurt jars with lids	yes	45°C	6 hours
Melt chocolate	Bowl	no	50°C	1 hour
Infusion oil	Bowl covered with cling wrap	yes	75°C	4 hours
Infusion water	Bowl covered with cling wrap	yes	65°C	4 hours
Dry tomatoes	Plate with baking paper	no	60°C	20 hours
Dry Vegetable	Plate	no	60°C	12 hours
Dry sliced fruits	Plate	no	60°C	12 hours
Dry herbs	Plate	no	70°C	4 hours
Dry bread for bread crumbs	Plate	no	80°C	4 hours
Confited Fish in oil	Tupperware Microwaveable	cover and open the vent	50°C	Depends on size between 1 to 2h.
White Melba toast	Plate	no	80°C	2 hours
Slow cooking stew	Pyrex container	yes	80°C	Between 1 to 12 hours

* Depending on model

Cleaning and care

 Danger of injury.

Do not use a steam cleaning appliance to clean this appliance. The steam could reach electrical components and cause a short circuit.

Danger of damage.

Unsuitable cleaning agents can damage the surfaces of the appliance. Only use domestic washing-up liquid to clean the appliance.

Clean and dry the entire appliance after each use. Allow the appliance to cool down to a safe temperature before cleaning.

Appliance front and interior

Remove any soiling immediately.

If this is not done, it might become impossible to remove and could cause the surfaces to alter or discolour.

Clean all surfaces with a clean sponge and a solution of hot water and washing-up liquid. Then dry with a soft cloth. A clean, damp microfibre E-cloth without cleaning agent can also be used.

All surfaces are susceptible to scratching. Scratches on glass surfaces could even cause a breakage.

Contact with unsuitable cleaning agents can alter or discolour the surfaces.

Cleaning and care

To avoid damaging the surfaces of your appliance, do not use:

- cleaning agents containing soda, ammonia, acids or chlorides,
- cleaning agents containing descaling agents,
- abrasive cleaning agents, e.g. powder cleaners and cream cleaners,
- solvent-based cleaning agents,
- stainless steel cleaning agents,
- dishwasher cleaner,
- oven sprays,
- glass cleaning agents,
- hard, abrasive sponges and brushes, e.g. pot scourers,
- sharp metal scrapers.

Anti-slip mat

Remove the anti-slip mat from the drawer before cleaning it.

- Clean the anti-slip mat by hand only, using a solution of hot water and a little washing-up liquid, and then dry with a cloth.

Do not put the anti-slip mat back into the drawer until it is completely dry.



Do not wash the anti-slip mat in a dishwasher or washing machine.

Never place the anti-slip mat in the oven to dry.



Problem solving guide

With the help of the following guide, minor faults in the performance of the appliance, some of which may result from incorrect operation, can be put right without contacting the Service Department.

 Installation work and repairs to electrical appliances must only be carried out by a suitably qualified person in strict accordance with current local and national safety regulations. Repairs and other work by unqualified persons could be dangerous.

Problem	Possible cause	Remedy
The appliance does not heat up.	The appliance is not correctly plugged in and switched on at the mains socket.	Insert the plug and switch on at the socket.
	The mains fuse has tripped.	Reset the trip switch in the mains fuse box (minimum fuse rating - see data plate). If, after resetting the trip switch in the mains fuse box and switching the appliance back on, the appliance will still not heat up, contact a qualified electrician.
The food is not hot enough.	The function for keeping food warm  is not selected.	Select the correct function.
	The temperature setting is too low.	Select a higher temperature.
	The vents are covered.	Ensure that the air can circulate freely.
The food is too hot.	The function for keeping food warm  is not selected.	Select the correct function.
	The temperature setting is too high.	Select a lower temperature.
The crockery is not warm enough.	The function for warming plates and dishes  is not selected.	Select the correct function.
	The temperature setting is too low.	Select a higher temperature.
	The vents are covered.	Ensure that the air can circulate freely.
	The crockery has not been allowed to heat up for a sufficiently long time.	Various factors will affect how long the crockery will take to heat up (see "Warming crockery").

Problem solving guide

Problem	Possible cause	Remedy
The crockery is too hot.	The function for warming plates and dishes  or  warming cups and glasses is not selected.	Select the correct function.
	The temperature setting is too high.	Select a lower temperature.
A noise can be heard when the drawer is being used.	The noise is caused by the fan which distributes the heat evenly through the drawer. The fan operates at intervals when the functions for keeping food warm and low temperature cooking are being used.	This is not a fault.

Safety instruction for installation

- ▶ Before connecting the appliance to the mains electricity supply make sure that the connection data on the data plate (voltage and frequency) correspond with the mains electricity supply, otherwise the appliance could be damaged. Consult a qualified electrician if in any doubt.
- ▶ The socket and on-off switch should be easily accessible after the appliance has been built in.
- ▶ The warming drawer may only be built in combination with those appliances quoted by the manufacturer as being suitable. The manufacturer cannot guarantee trouble-free operation if the appliance is operated in combination with appliances other than those quoted by the manufacturer as being suitable.
- ▶ When building in the warming drawer in combination with another suitable appliance, the food warming drawer must be fitted above a fixed interim shelf in the housing unit. Please ensure that the housing unit can support both its weight and that of the other appliance.
- ▶ As the combination appliance is placed directly on top of the warming drawer once it is built in, an interim shelf is not necessary between the two appliances.
- ▶ The appliance must be built in so that the contents of the drawer can be seen. This is to avoid scalding from hot food spilling over. There must be enough space for the drawer to be pulled out fully.
- ▶ The warming drawer is available in two models, which differ in opening the door. The building-in dimensions for the warming drawer must be added to the building-in dimensions for the combination appliance to establish the **niche size** required.

When building in the combination appliance, it is essential to follow the instructions given in the operating and installation instructions supplied with the combination appliance.

All dimensions in this instruction booklet are given in mm.

Building-in dimensions

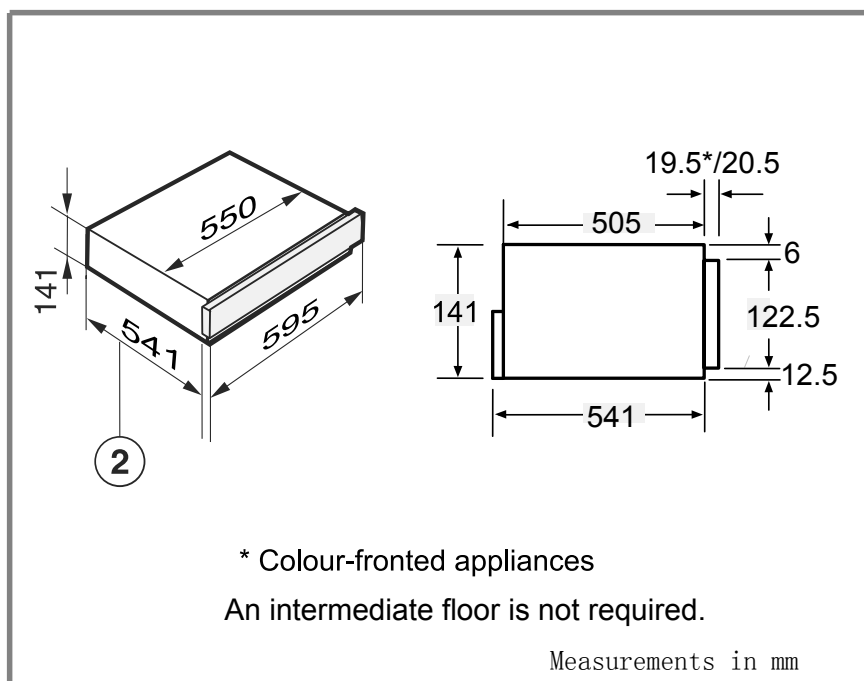
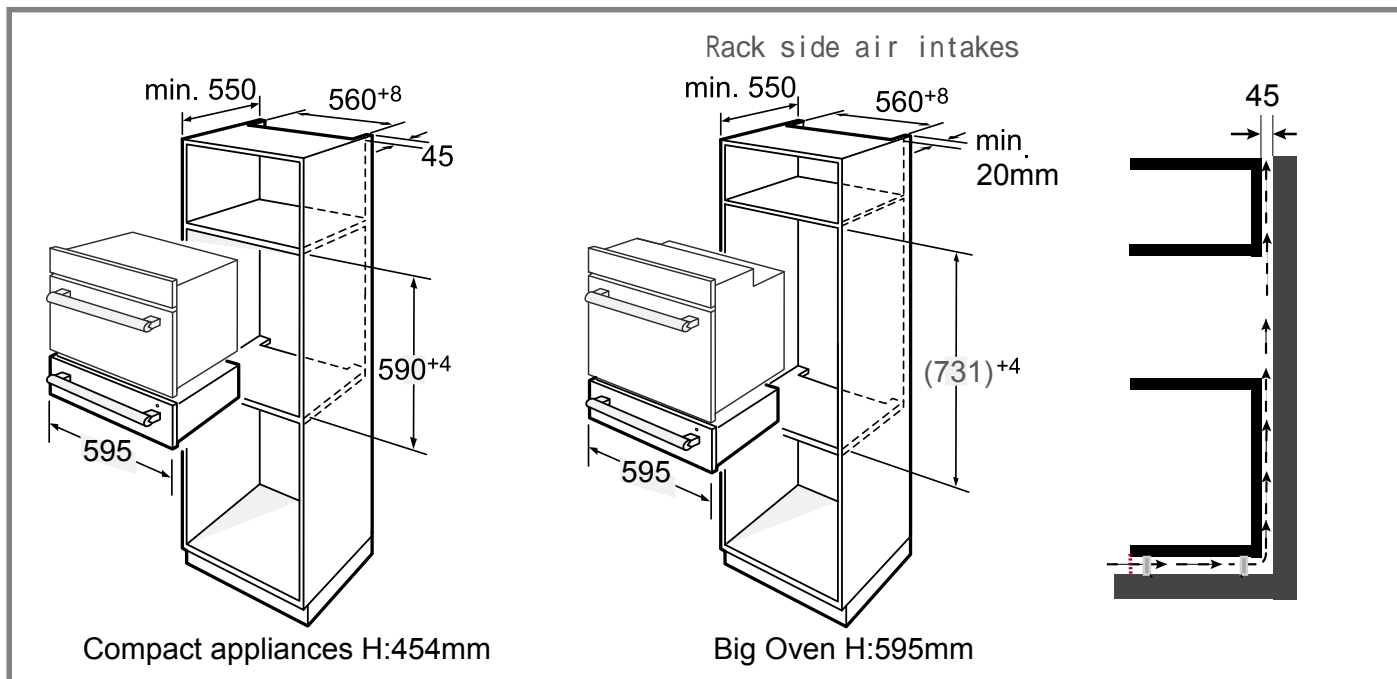

- ① Ventilation cut-out required when combined with a pyrolytic oven
- ② Building-in dimension including mains supply cable connection
Connection cable L = 1000 mm
- * Appliances with glass front
- ** Appliances with metal front

NOTE:
The maximum power of compact appliances is 3350W.

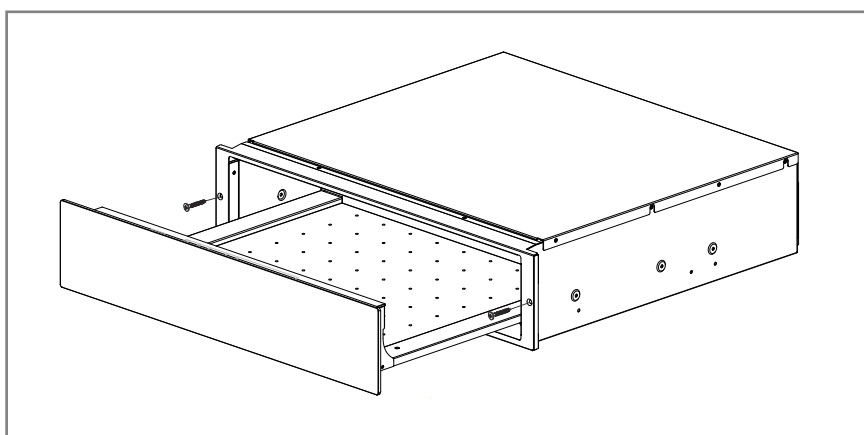

Technical data

Power supply:	220 -240 V
	50/60Hz
Total connected load:	1000 W

Environmental protection

Unpack the appliance and dispose of the packaging in an environmentally-responsible manner.

Environmental protection



This appliance is labelled in accordance with the European Directive 2002/96/EU concerning used electrical and electronic appliances (WEEE – waste electrical and electronic equipment). The guideline determines the framework for the return and recycling of used appliances as applicable.

GDHA Customer Care

Please keep this handbook in a safe place.

Please fill in the model number and serial number in the spaces provided below as they will assist us should you need to call.

0844 815 3747

When you dial this number you will hear a recorded message and be given a number of options. This indicates that your call has been accepted and is being held in a queue. Calls are answered in strict rotation as our Customer Care Representatives become available.

Enter appliance numbers here for future reference:

Model No									
Serial No									

These numbers can be found on your appliances.
Outside the UK and Northern Ireland, refer to your local supplier.



GLEN DIMPLEX
HOME APPLIANCES

Stoney Lane, Prescot, Merseyside, L35 2XW