



Russell Hobbs



instructions

£10,000 prize draw
EXTRA year guarantee
FREE rewards gallery
www.russellhobbs.co.uk/productregister/
Register online now!
See back for details

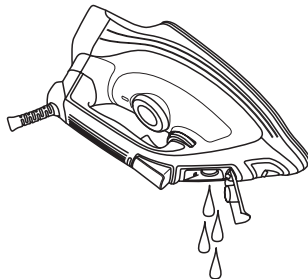
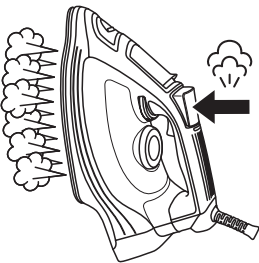
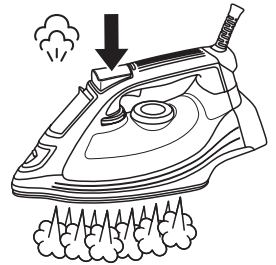
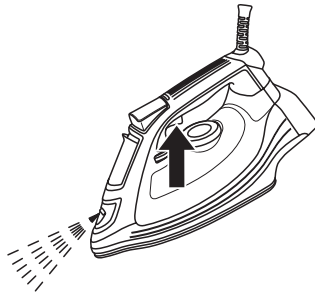
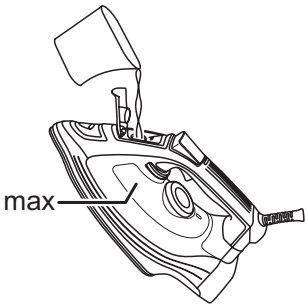
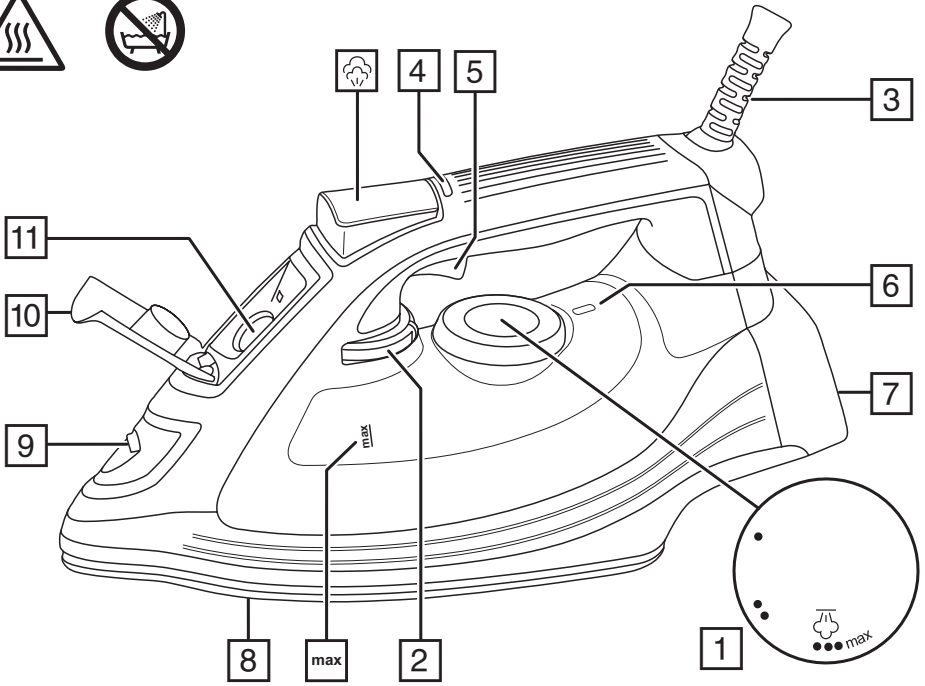

Read the instructions, keep them safe, pass them on if you pass the iron on.

IMPORTANT SAFEGUARDS

Follow basic safety precautions, including:

This appliance can be used by children aged from 8 years and above and persons with reduced physical, sensory or mental capabilities or lack of experience and knowledge if they have been supervised/instructed and understand the hazards involved. Children shall not play with the appliance. Cleaning and user maintenance shall not be done by children unless they are older than 8 and supervised. Use and store the appliance out of reach of children under 8 years.

Use the iron, or set it on its heel, on a stable, level, heat-resistant surface, preferably an ironing board.

Don't leave the iron unattended while plugged in, or while it's standing on the ironing board.

Unplug the iron before filling, before cleaning, and after use.

Don't operate the appliance if it's dropped or damaged, or if it malfunctions or leaks.

If the cable is damaged, return the iron in order to avoid a hazard.

 The surfaces of the appliance will get hot during use.

- Don't put the appliance in liquid, don't use it in a bathroom, near water, or outdoors.
- Never iron clothing while it is being worn.
- Don't use the appliance for any purpose other than those described in these instructions.
- Don't scratch the soleplate – avoid buttons, zips, etc.
- The appliance has a protective thermal fuse which will blow if it overheats. If this happens, the appliance will stop working, and must be returned for repair.

HOUSEHOLD USE ONLY

PARTS

- | | |
|------------------------|-----------------|
| 1. Temperature control | 7. Heel |
| 2. Steam control | 8. Soleplate |
| 3. Swivel cord | 9. Spray nozzle |
| 4. Light | 10. Cover |
| 5. Trigger | 11. Water inlet |
| 6. Marker | |

BEFORE USING FOR THE FIRST TIME







- Remove labels, stickers and packaging from the iron and soleplate.
- Don't worry if the iron smokes a little at first. It will stop after a short time.
- Iron an old piece of cotton fabric, to clean the soleplate.

AUTO SHUT-OFF





- If the iron is motionless, it will switch off after about 30 seconds with the soleplate down or on its side, or about 8 minutes if it's upright.

- The light will flash and keep flashing till you move the iron.
- To switch on again, lift it up, tilt it forward, then sit it upright to return to operating temperature.
- No settings are lost during auto shut-off.

PREPARATION

1. Check for textile care symbols (   .
2. Iron fabrics needing low temperatures  first, then those that need medium temperatures , and finish with those needing high temperatures .

TEMPERATURE SETTING GUIDE

Label marking	Dot setting
 cool – nylon, acrylics, polyester	•
 warm – wool, polyester mixtures	••
 hot – cotton, linen	•••
Max – denim	max
 do not iron	-

If the instructions on the fabric label differ from this guide, follow the instructions on the label.

FILLING

You may use the iron with tap-water, but if you live in a hard water area, you should use distilled water (not chemically descaled or softened water).



If you buy distilled water, check that it's suitable for use in irons.

1. Set the temperature control to • and set the steam control to .
2. Unplug the iron.
3. Hold the iron with the front raised.
4. Open the water inlet cover.
5. Pour slowly, to let the air in the reservoir escape, otherwise you'll cause an air lock and the water will overflow.
6. Don't fill past the **max** marking or water will escape in use.
7. Wipe up any spillage.

SWITCH ON

1. Set the temperature control to • and set the steam control to .
2. Stand the iron on its heel.
3. Put the plug into the power socket (switch the socket on, if it's switchable).
4. Turn the temperature control to bring the setting you want next to the marker. The light will come on.
5. When the iron reaches the temperature you set, the light will go out. It'll then cycle on and off as the thermostat operates to maintain the temperature.

STEAM IRONING



1. To steam iron, set the temperature control to  or higher.
2. Set the steam control to the setting you want,  = no steam,  = high steam.
3. Wait till the light goes out, then start ironing.

SPRAY

Water spotting affects some fabrics. Test this out on a hidden part of the fabric.

1. Lift the iron off the fabric.
2. Aim the spray nozzle at the fabric.
3. Squeeze the trigger as required. You may have to squeeze it 2 or 3 times to pump water through the system.

SHOT OF STEAM



1. Check that the temperature control is at  or higher.
 2. Lift the iron off the fabric.
 3. Press the  button.
- Leave 4 seconds between shots to let the temperature build up.

DRY IRONING

1. If you're going to be dry ironing for 20 minutes or more, empty the reservoir first to avoid spontaneous bursts of steam.
2. Set the steam control to .
3. Set the desired temperature.
4. Wait till the light goes out, then start ironing.

VERTICAL STEAMING

Remove wrinkles from hanging clothes, hanging curtains, and furnishing fabrics.

- Check that there's adequate ventilation behind the fabric, otherwise moisture may build up, causing mildew.
 - Check that there's nothing behind the fabric that may be damaged by the steam.
 - Check that pockets, turn-ups, and cuffs are empty.
 - Check that there's water in the reservoir.
1. Set the temperature control to **max** and set the steam control to .
 2. Hold the iron close to (but not touching) the fabric.
 3. Press the  button.
- Leave 4 seconds between shots, to let the temperature build up.

AFTER USE



1. Set the temperature control to **•** and set the steam control to .
2. Unplug the iron.
3. Open the water inlet cover.
4. Hold the iron over a sink, turn it upside down and drain the water from the reservoir.
5. Stand the iron on its heel and leave it to cool down completely.
6. When cold, wipe off any moisture and close the water inlet cover.
7. Wipe outer surfaces with a damp cloth.
8. Remove spots from the soleplate with a little vinegar – take care not to scratch it.
9. Store the iron on its heel, to avoid corrosion and damage to the soleplate.

SELF CLEAN

To avoid scale build up, use the self clean function at least monthly in normal water areas, more often in hard water areas.

You'll need a basin or a large bowl to catch the water coming out of the soleplate.

1. Fill the reservoir to the **max** mark.
2. Set the temperature control to **max** and set the steam control to .
3. Stand the iron on its heel.

4. Put the plug into the power socket and wait till the light goes out.
5. Hold the iron over the basin or bowl, with the soleplate down.
6. Move the steam control past  to  and hold it there.
7. Gently move the iron to and fro, over the basin or bowl.
8. Water and steam will wash scale and dust through the soleplate, and into the sink.
9. When water and steam stop coming from the soleplate, release the steam control.
10. Unplug the iron, and stand it on its heel to cool.
11. Follow the steps under AFTER USE.

ANTI-SCALE

The anti-scale agent incorporated in the iron helps prevent the build-up of scale. Don't use a descaling solution, or you'll destroy the anti-scale agent.

ENVIRONMENTAL PROTECTION

To avoid environmental and health problems due to hazardous substances in electrical and electronic goods, appliances marked with this symbol mustn't be disposed of with unsorted municipal waste, but recovered, reused, or recycled.

SERVICE

If you ring Customer Service, please have the Model No. to hand, as we won't be able to help you without it. It's on the rating plate (usually underneath the product).

The product isn't user-serviceable. If it's not working, read the instructions, check the plug fuse and main fuse/circuit breaker. If it's still not working, consult your retailer.

If that doesn't solve the problem – ring Customer Service – they may be able to offer technical advice.

If they advise you to return the product to us, pack it carefully, include a note with your name, address, day phone number, and what's wrong. If under guarantee, say where and when purchased, and include proof of purchase (till receipt). Send it to:

Customer Service

Spectrum Brands (UK) Ltd

Fir Street, Failsworth, Manchester M35 0HS

email: support@russellhobbs.com

telephone: 0845 658 9700 (local rate number)

GUARANTEE

Defects affecting product functionality appearing within two years of first retail purchase will be corrected by replacement or repair provided the product is used and maintained in accordance with the instructions. Your statutory rights are not affected. Documentation, packaging, and product specifications may change without notice.

ONLINE

www.russellhobbs.co.uk for more products

REGISTER ONLINE FOR –



£10,000 prize draw,

EXTRA year guarantee,

FREE rewards gallery

Visit www.russellhobbs.co.uk/productregister/

You must register within 28 days of purchase.