

IND.4015718_001

CUGGL MALIBU

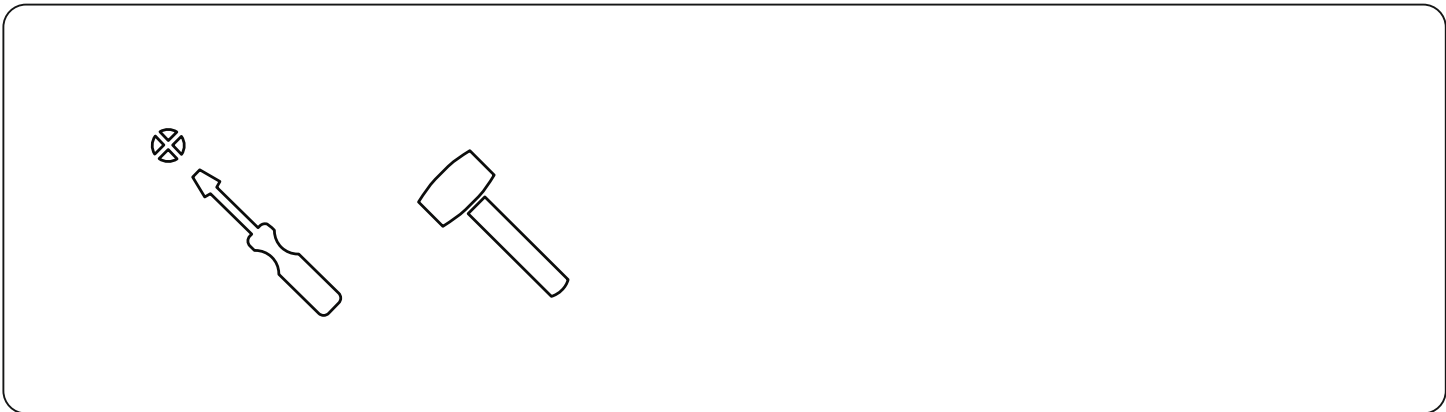

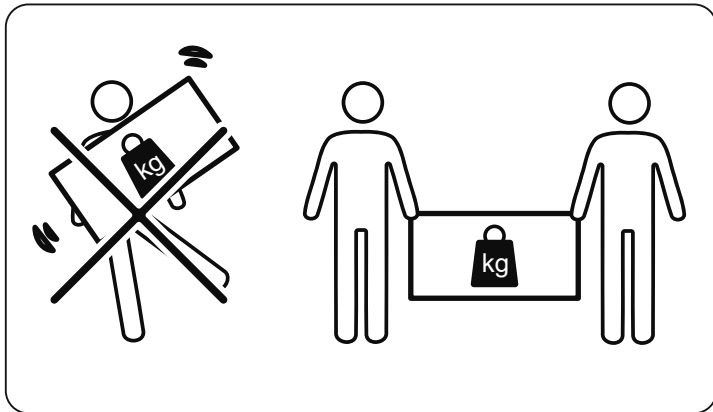
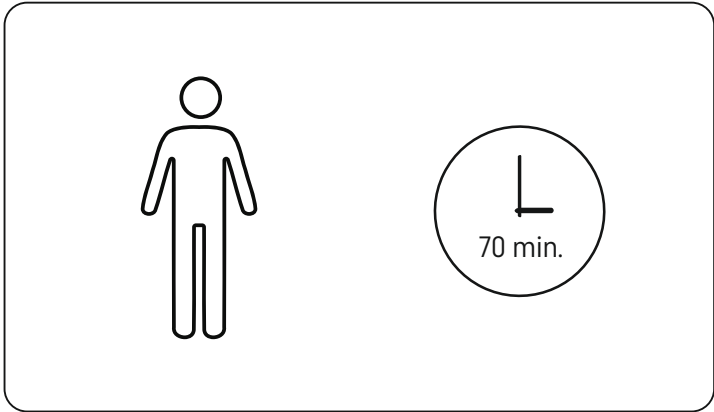
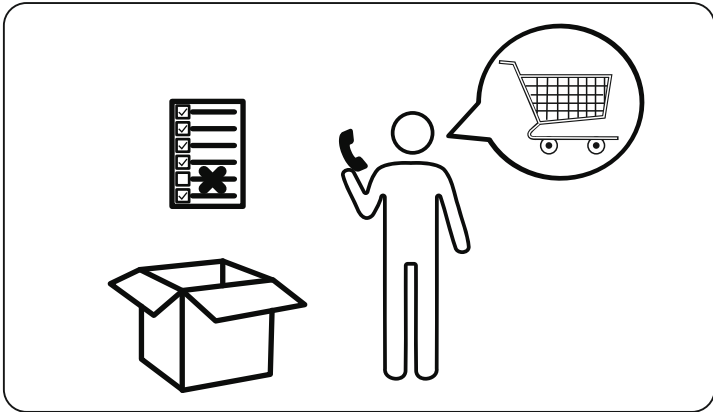
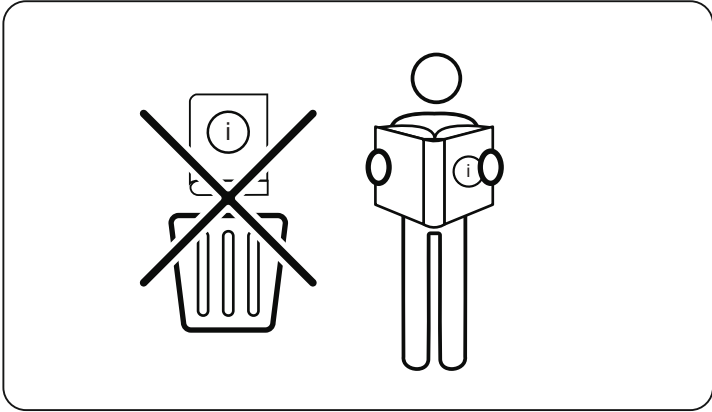
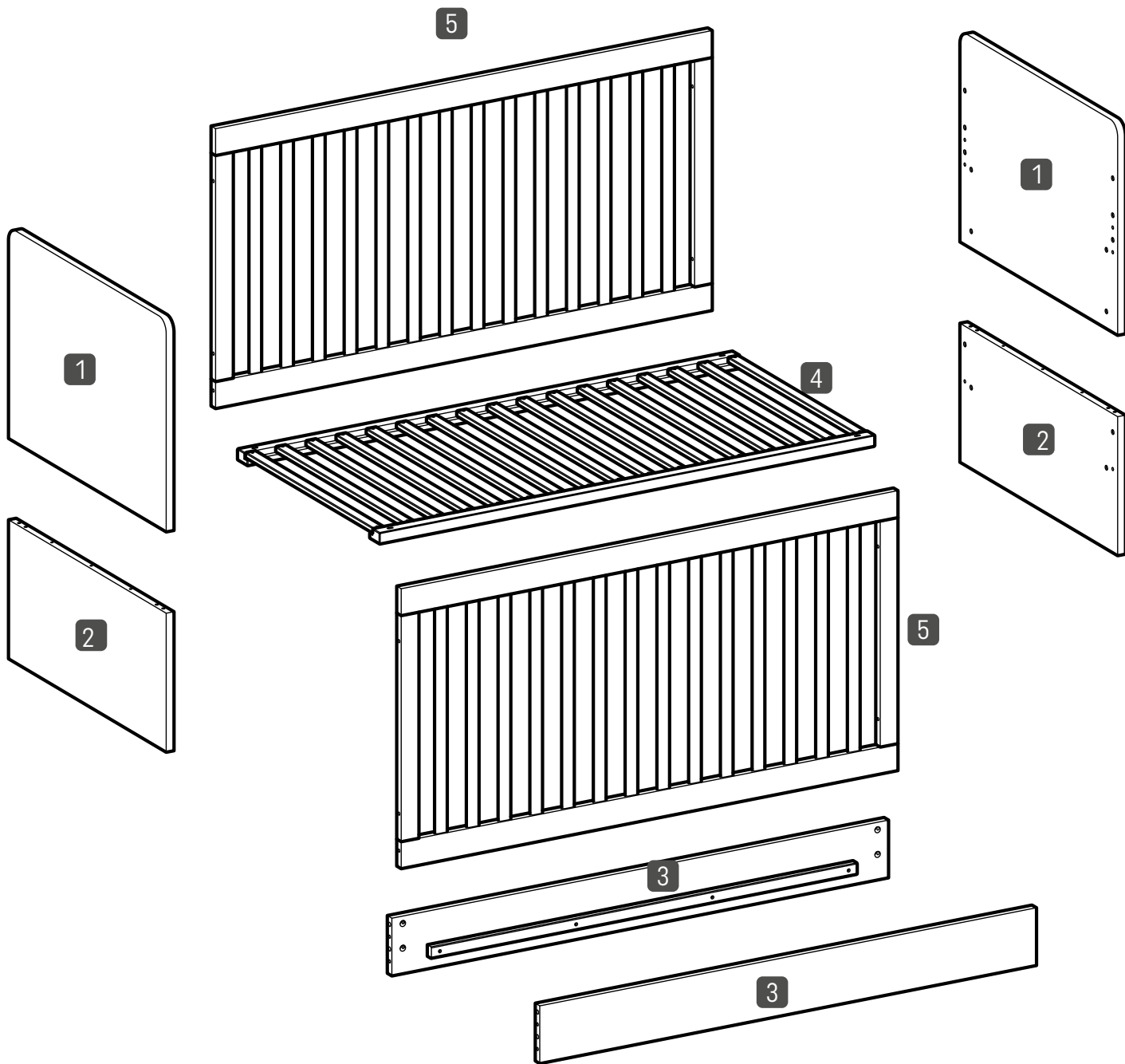
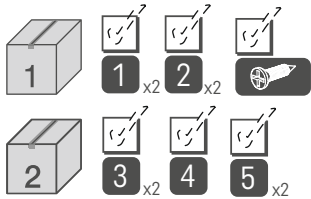

en

IMPORTANT!
RETAIN FOR FUTURE REFERENCE:
READ CAREFULLY

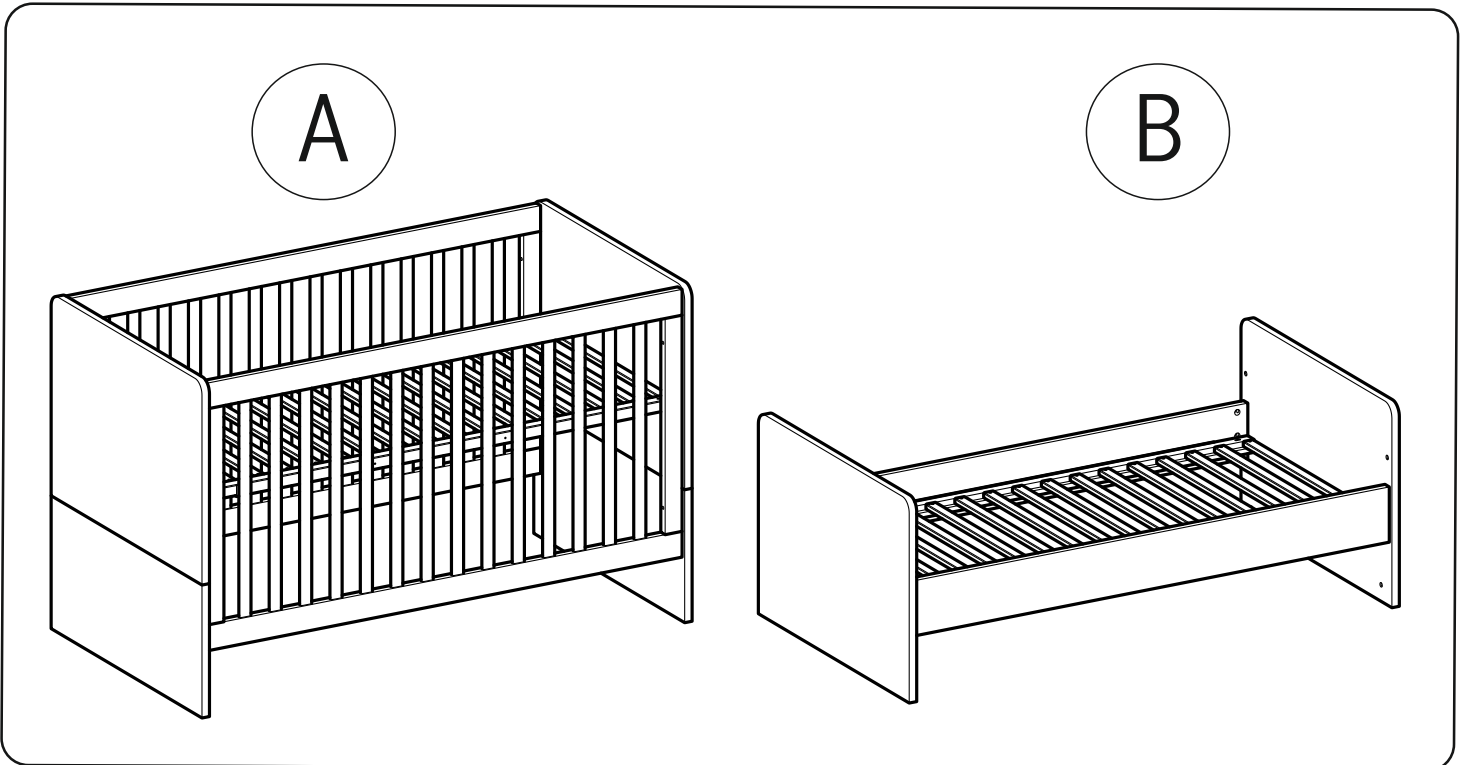
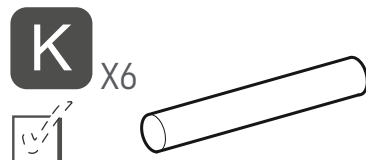
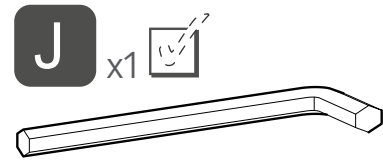
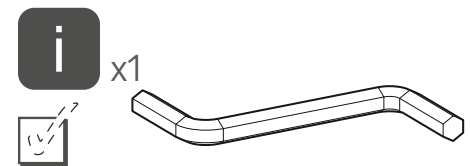
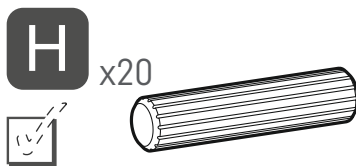
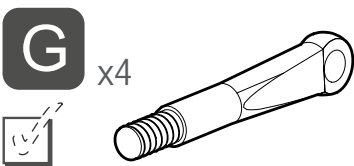
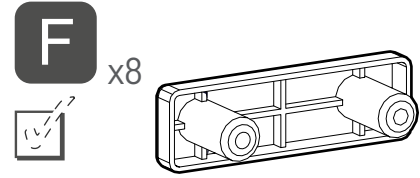
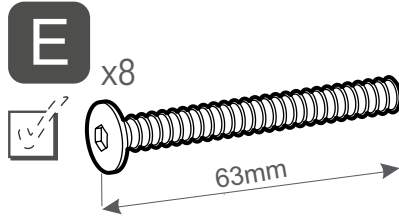
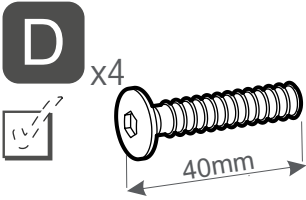
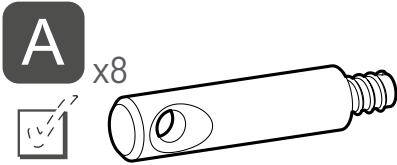
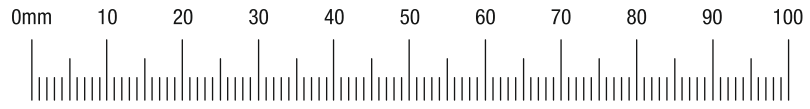

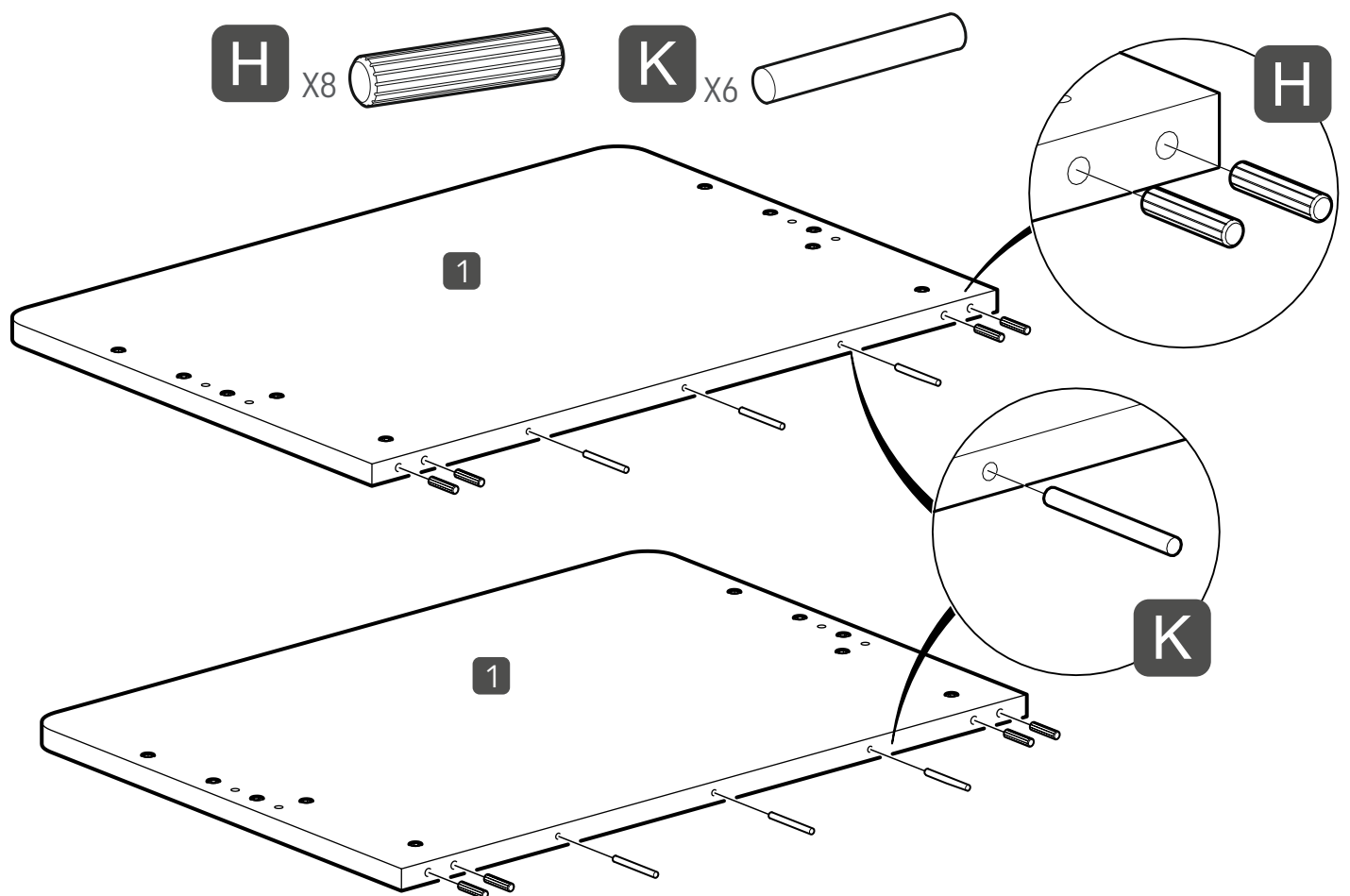
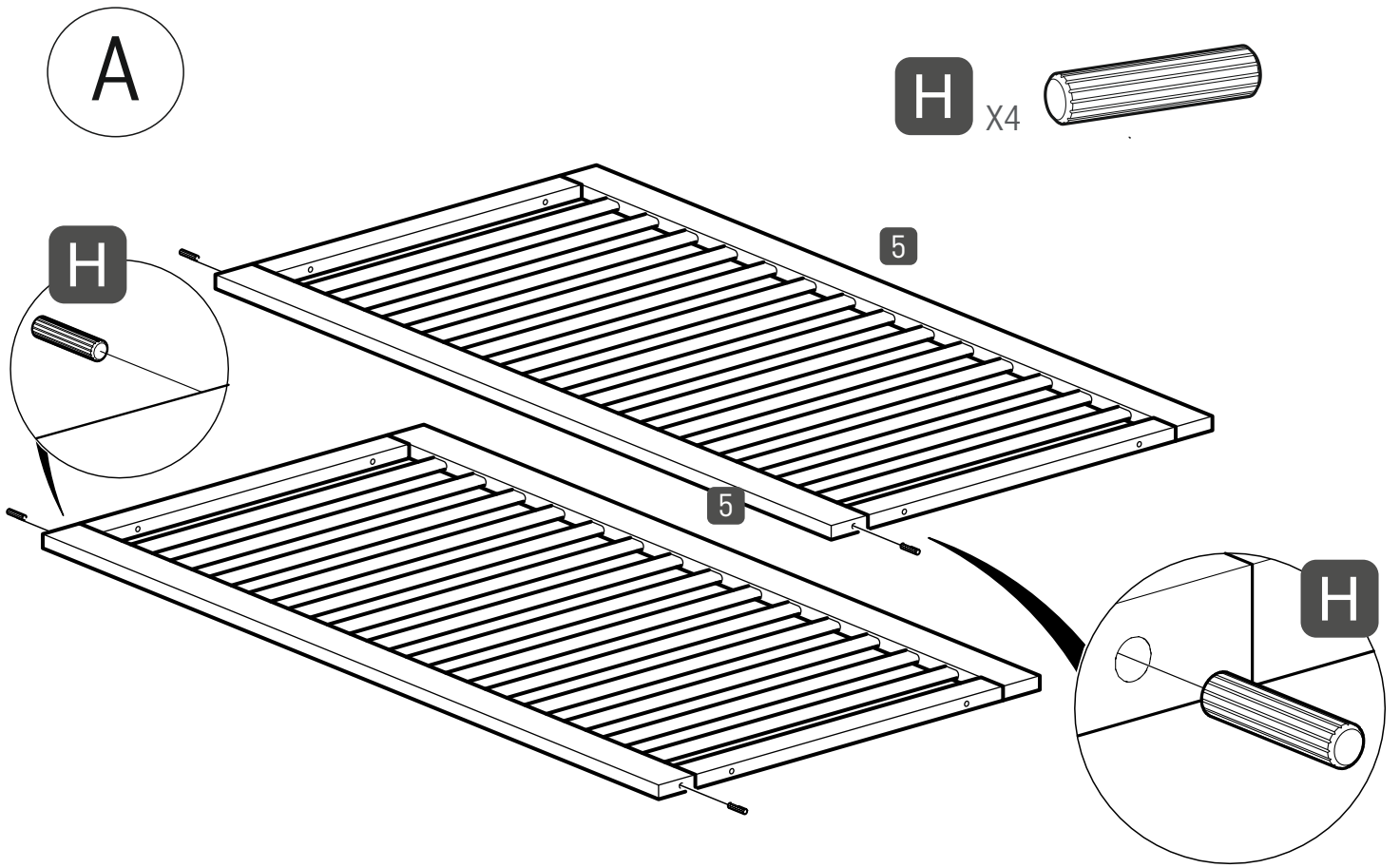

A

F x4

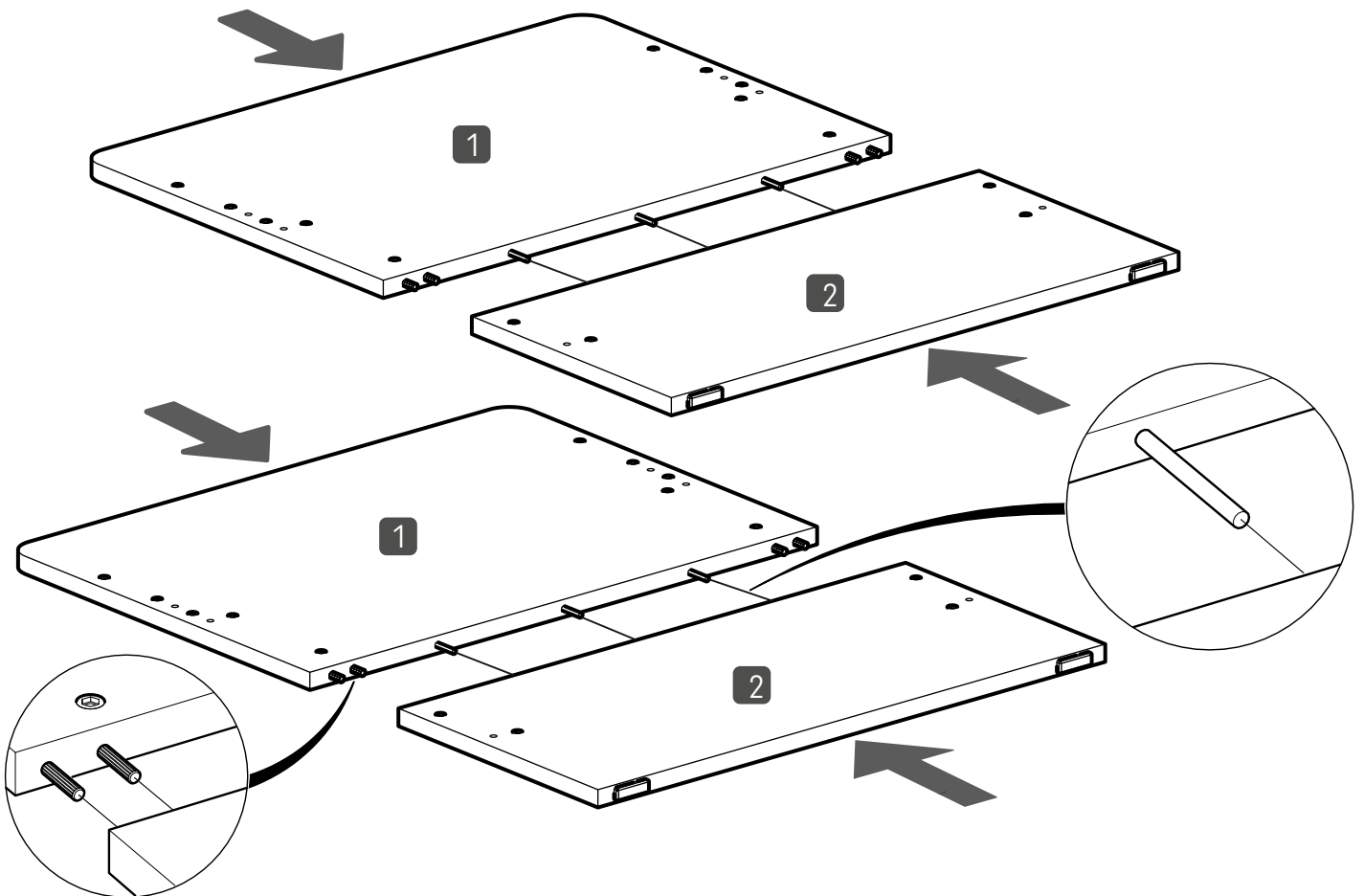
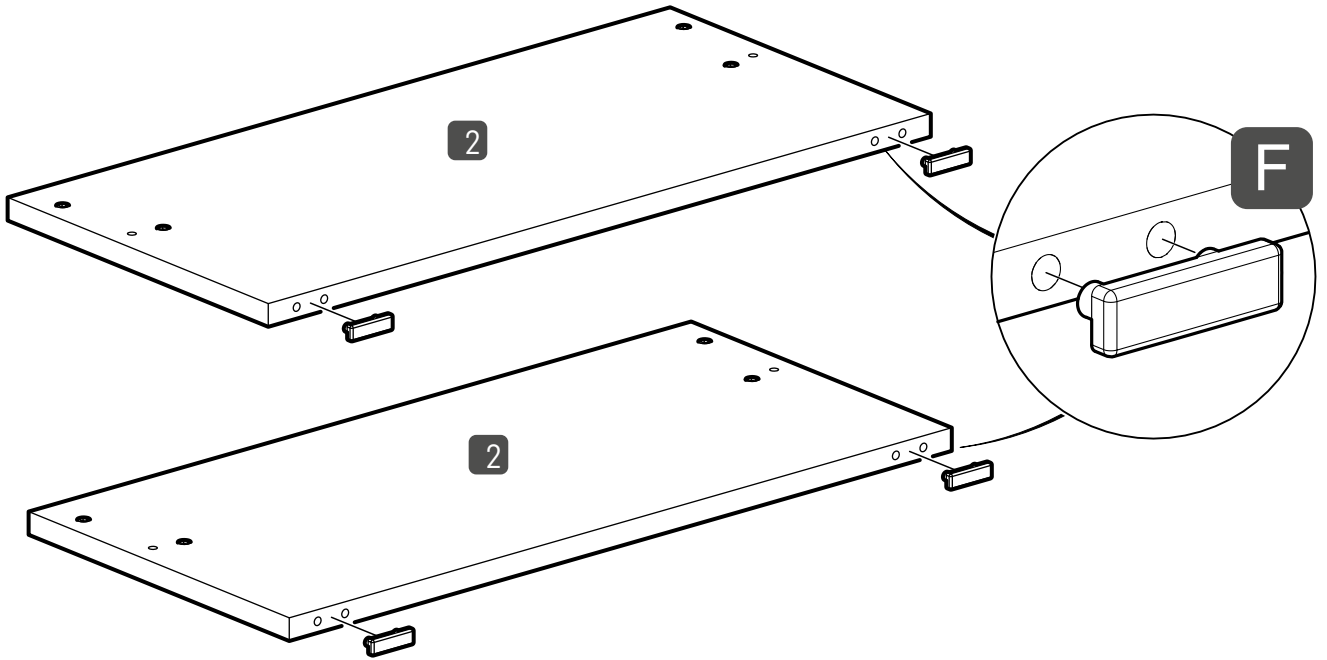
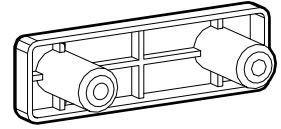

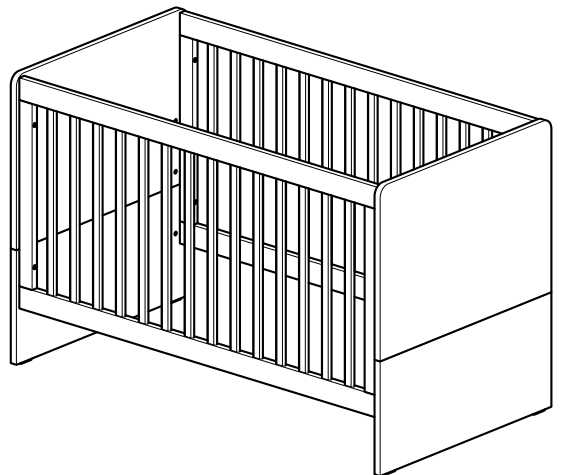
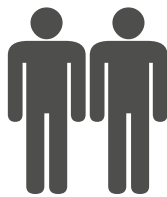
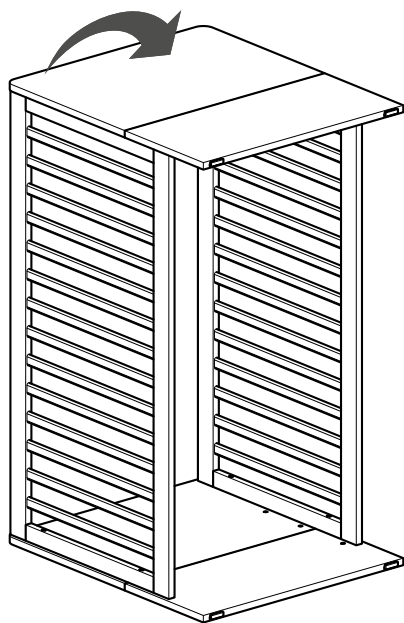
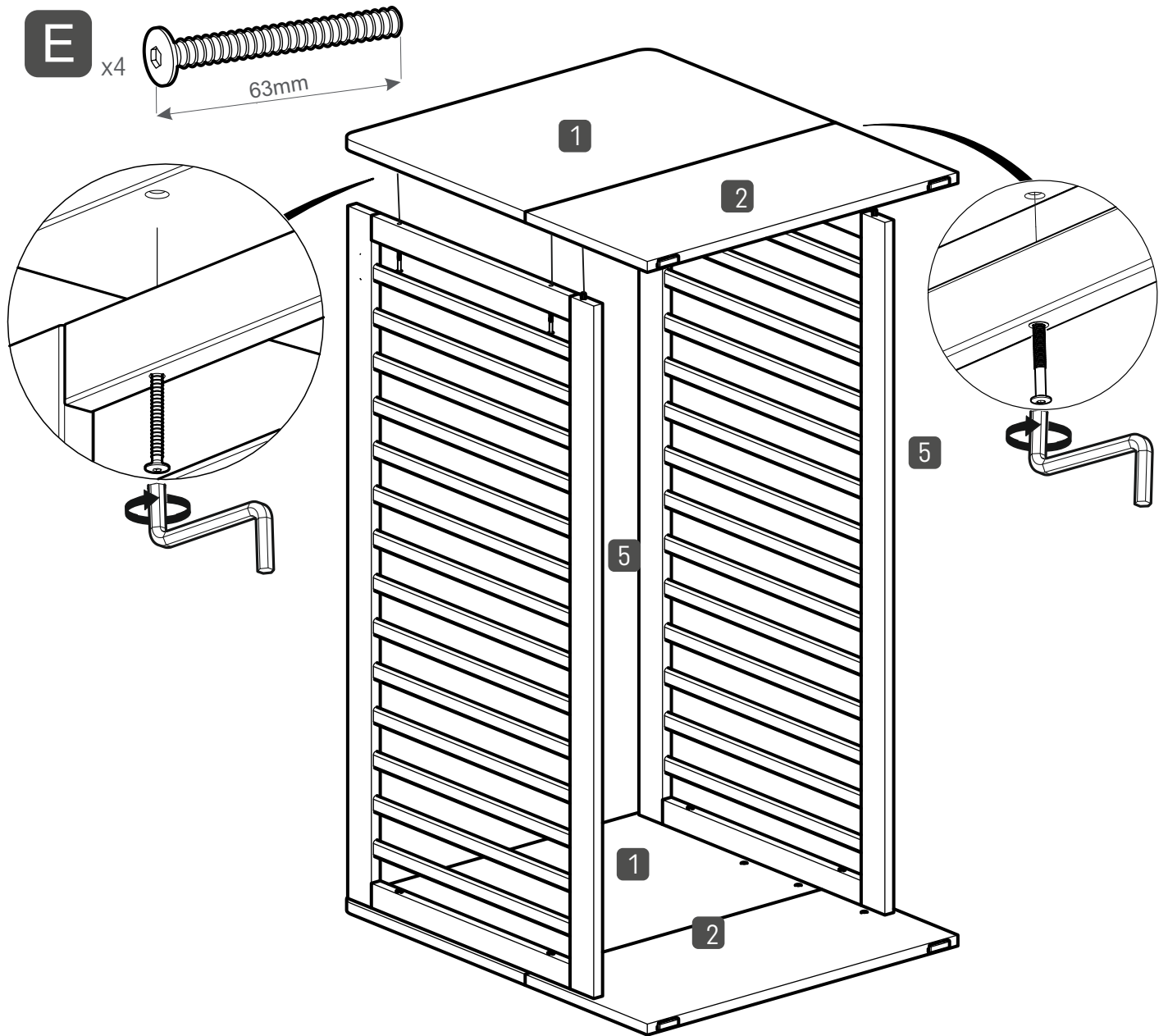

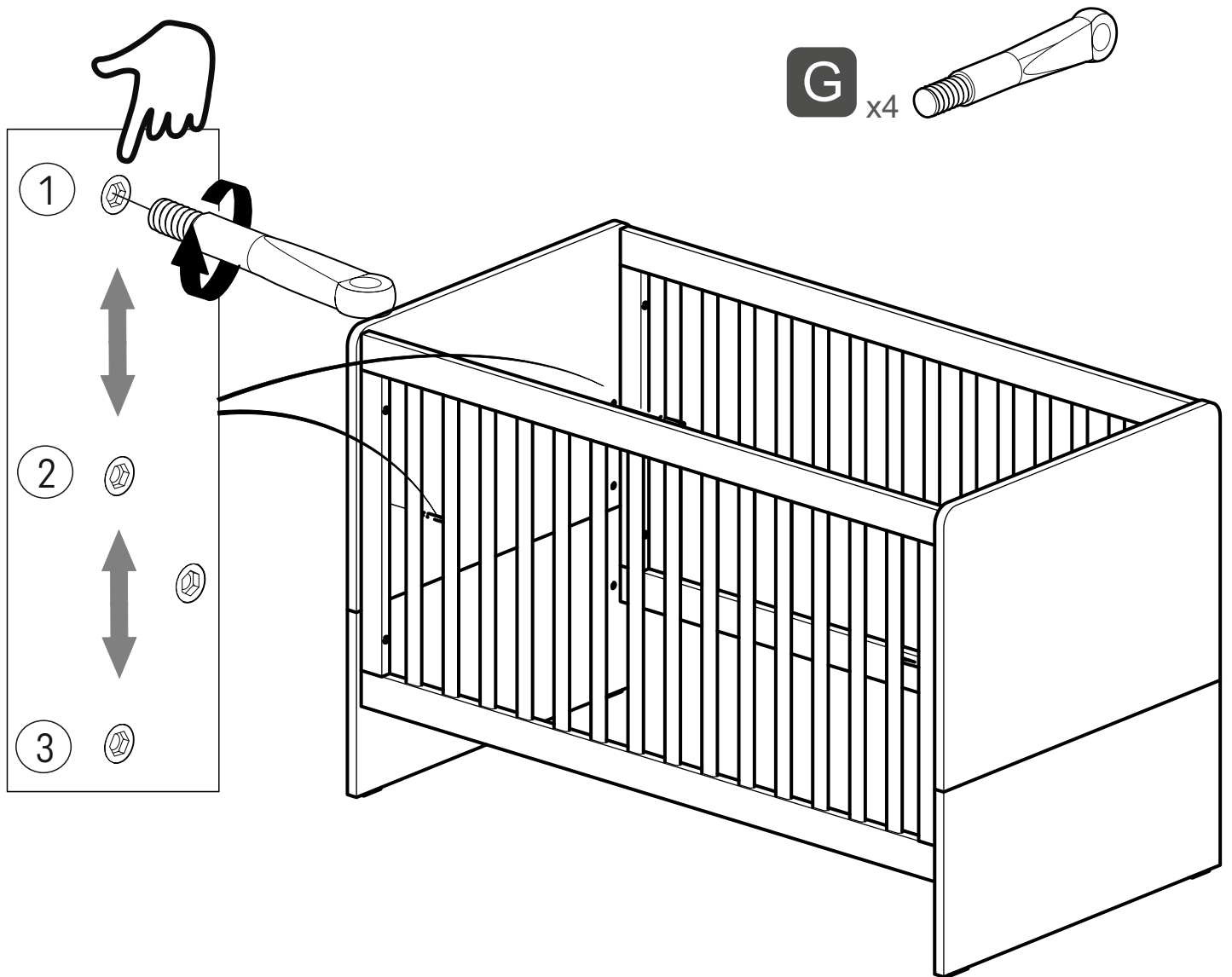
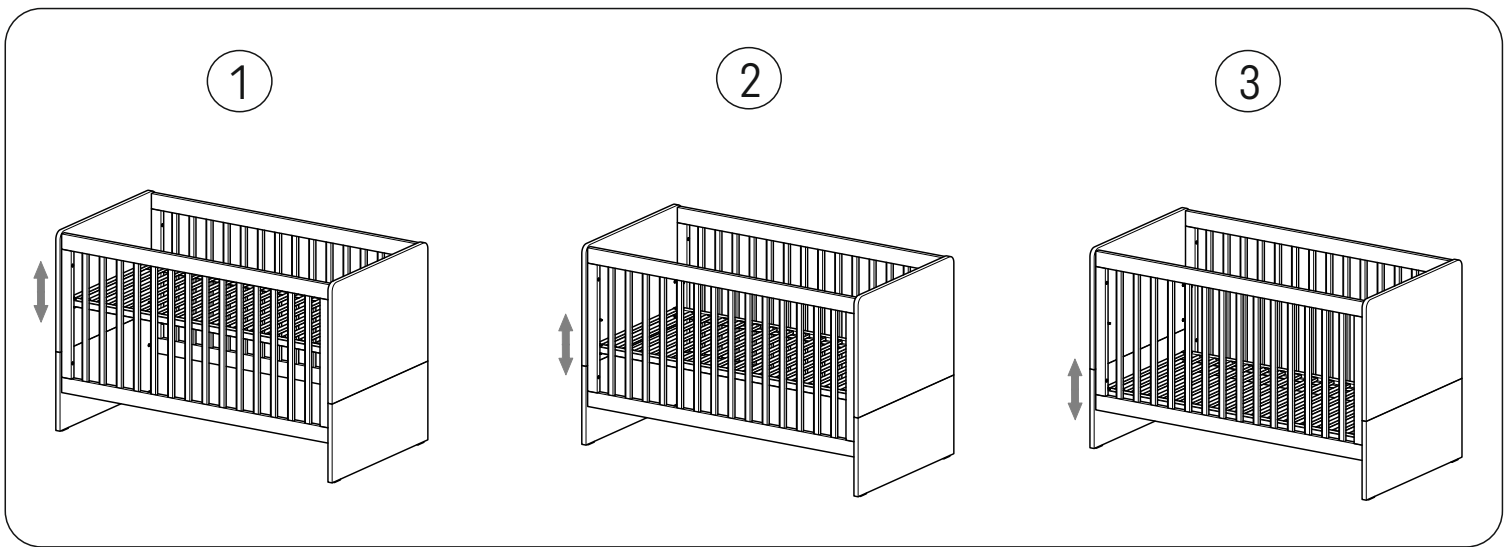

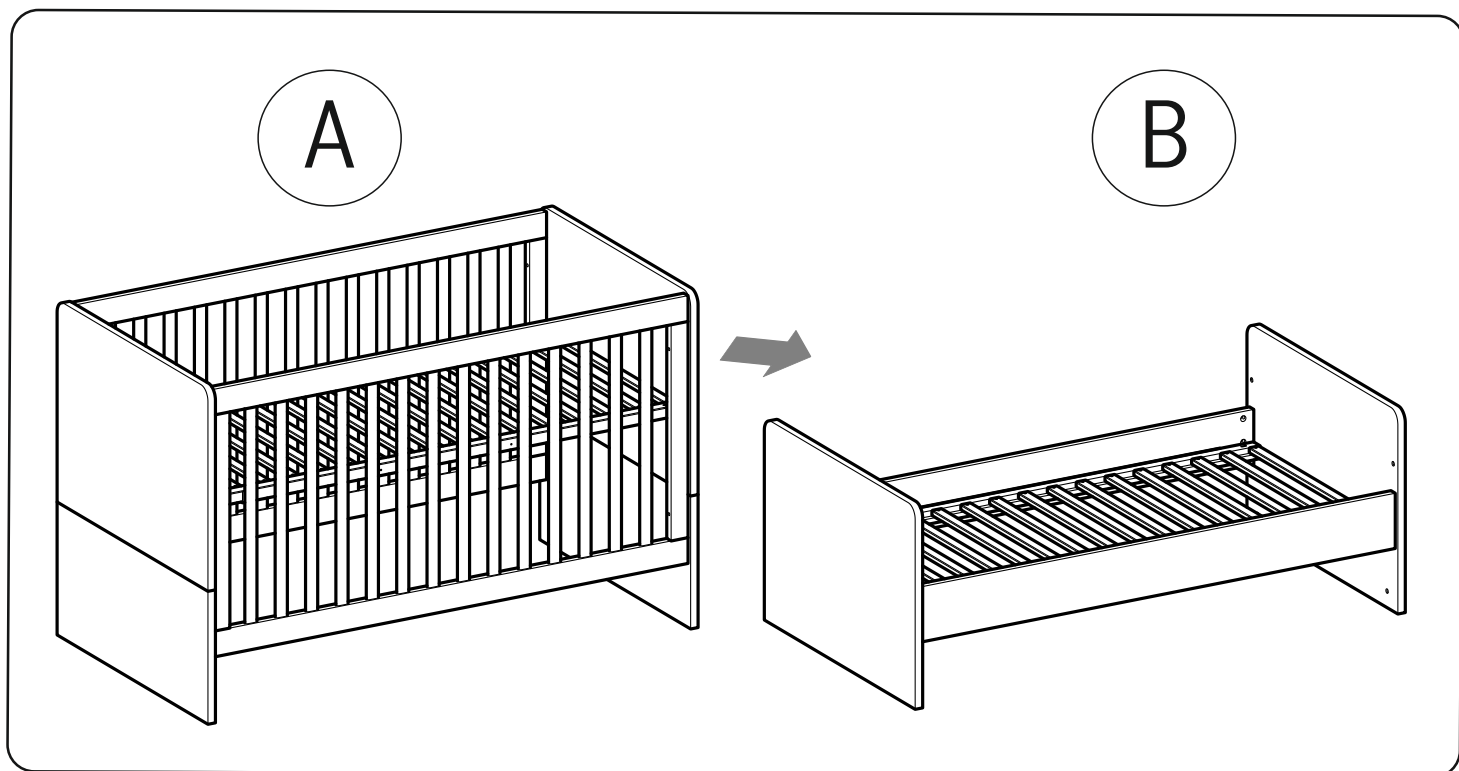
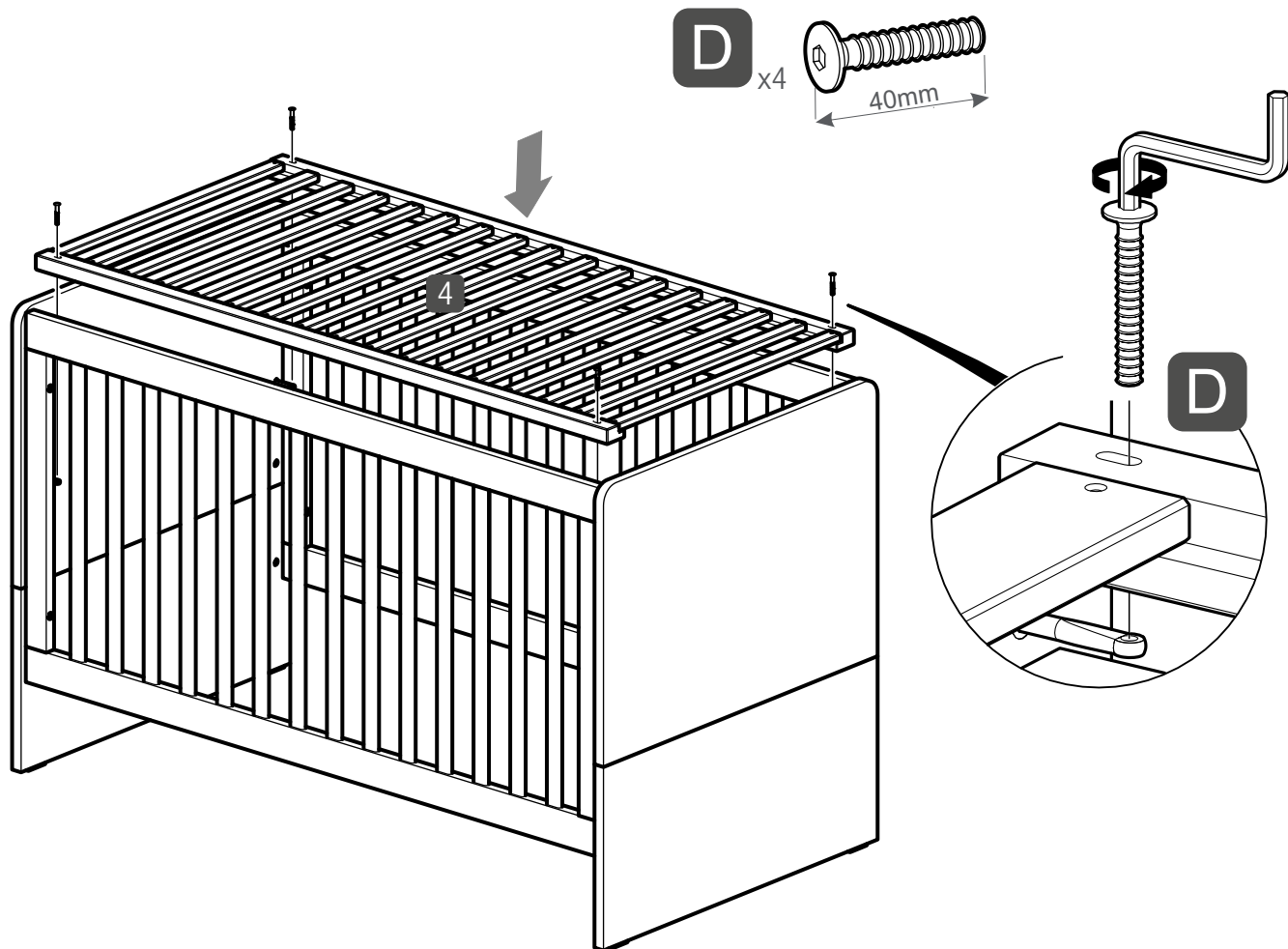

B

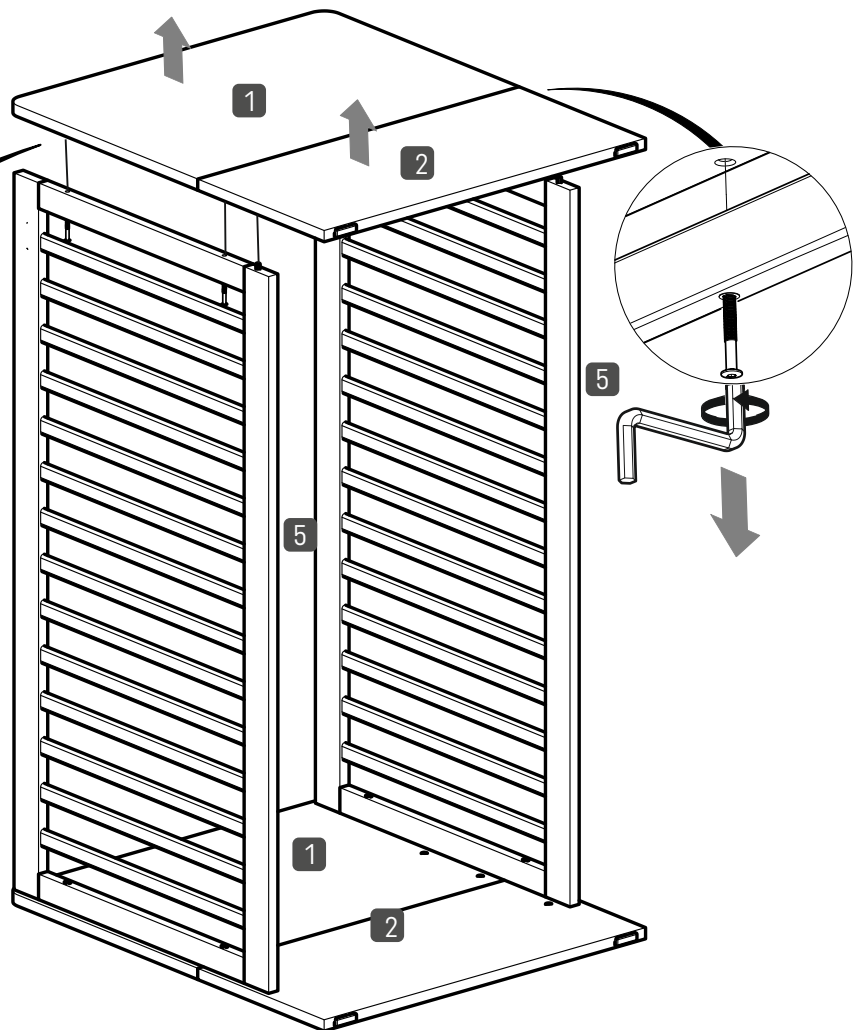
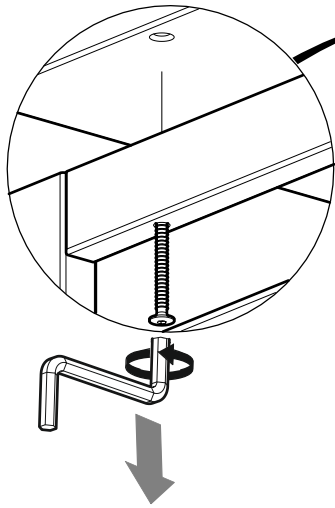
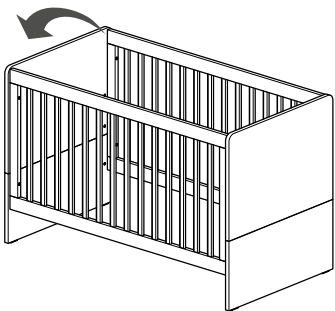
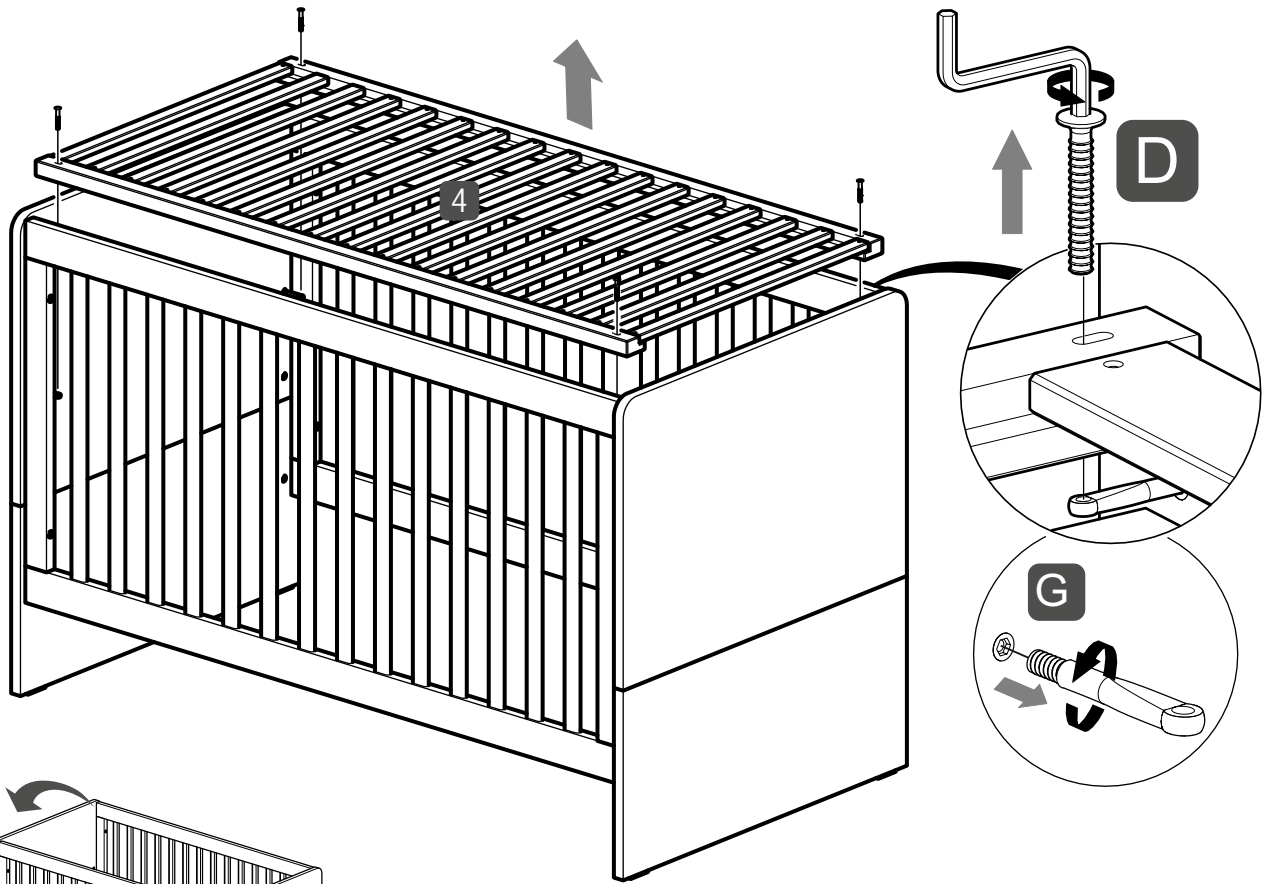

B

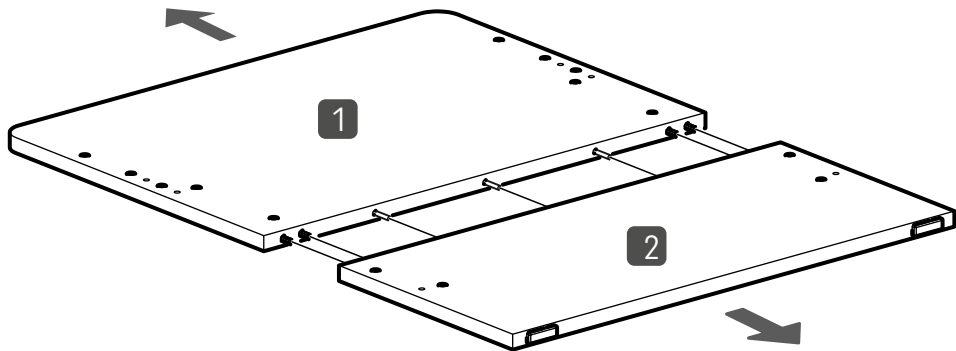
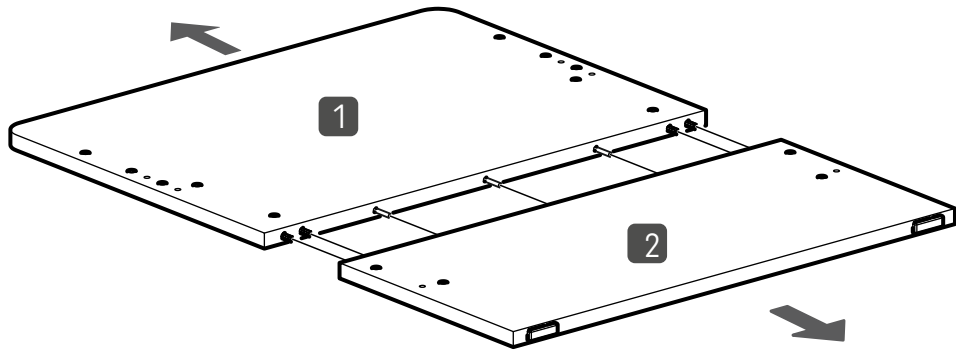
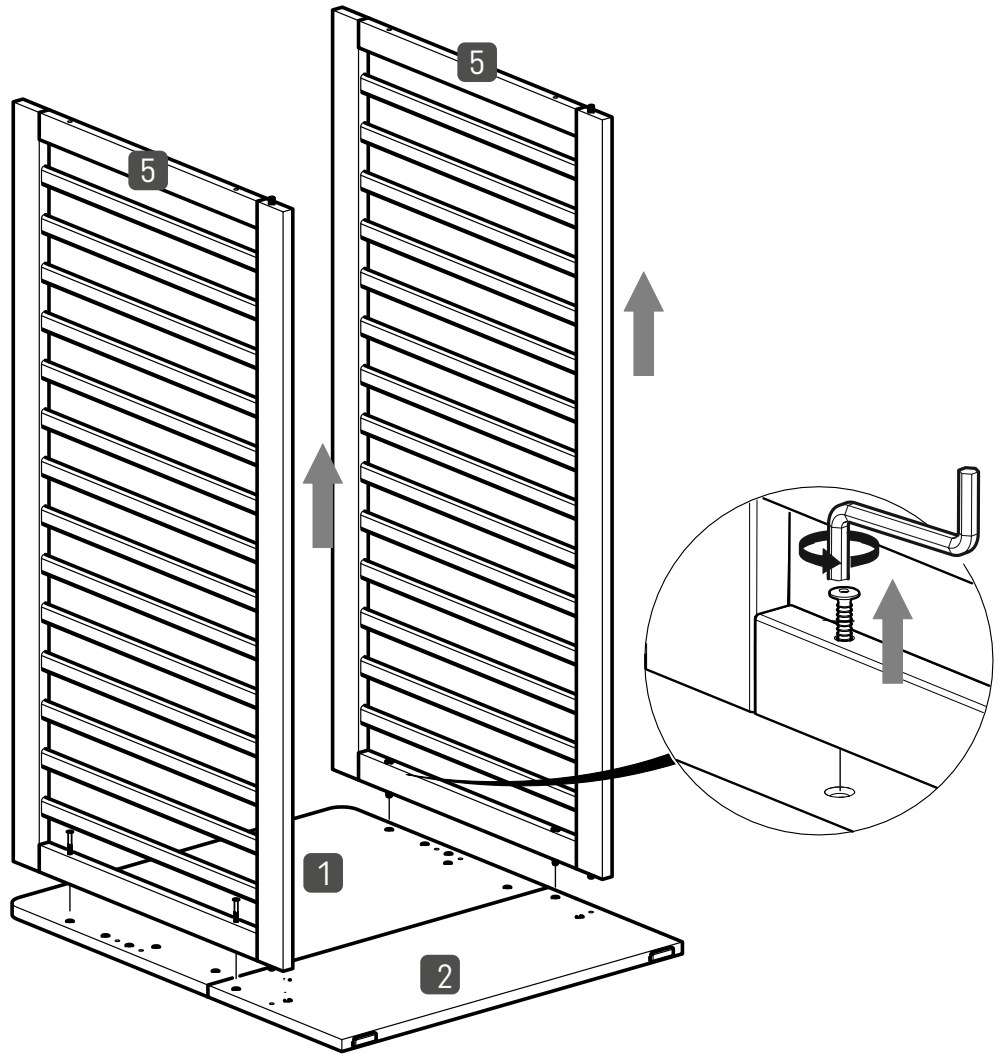

B

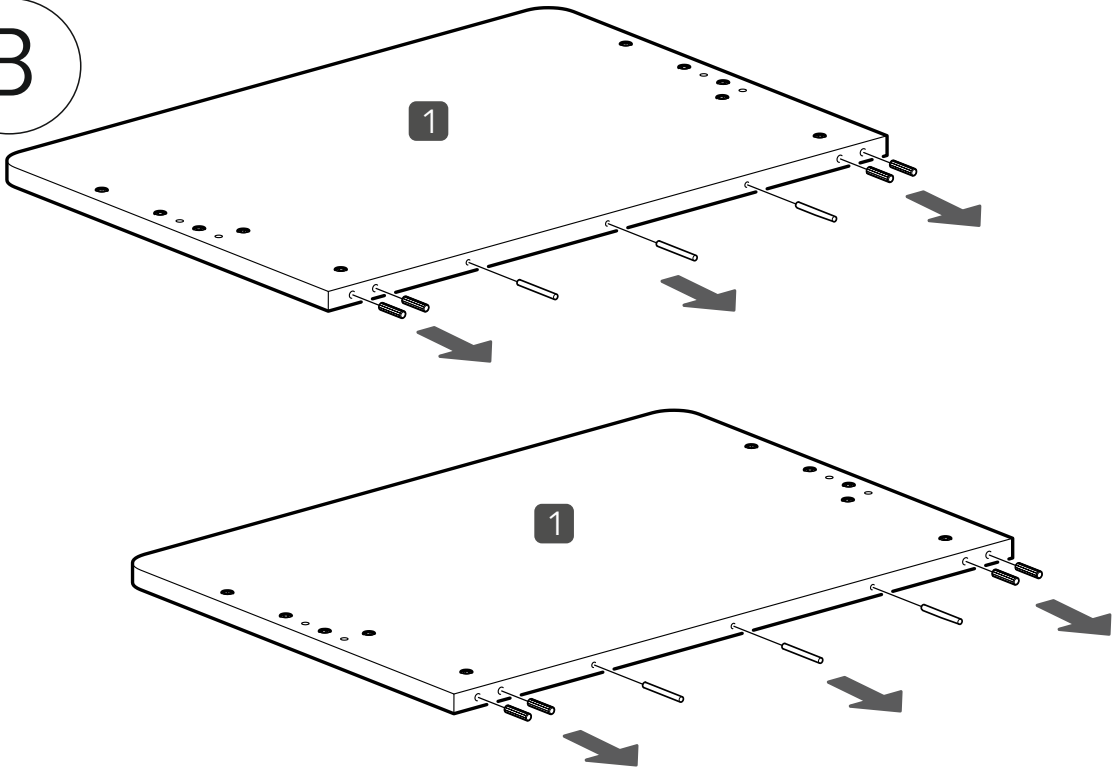

A x8

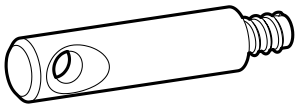

F x4

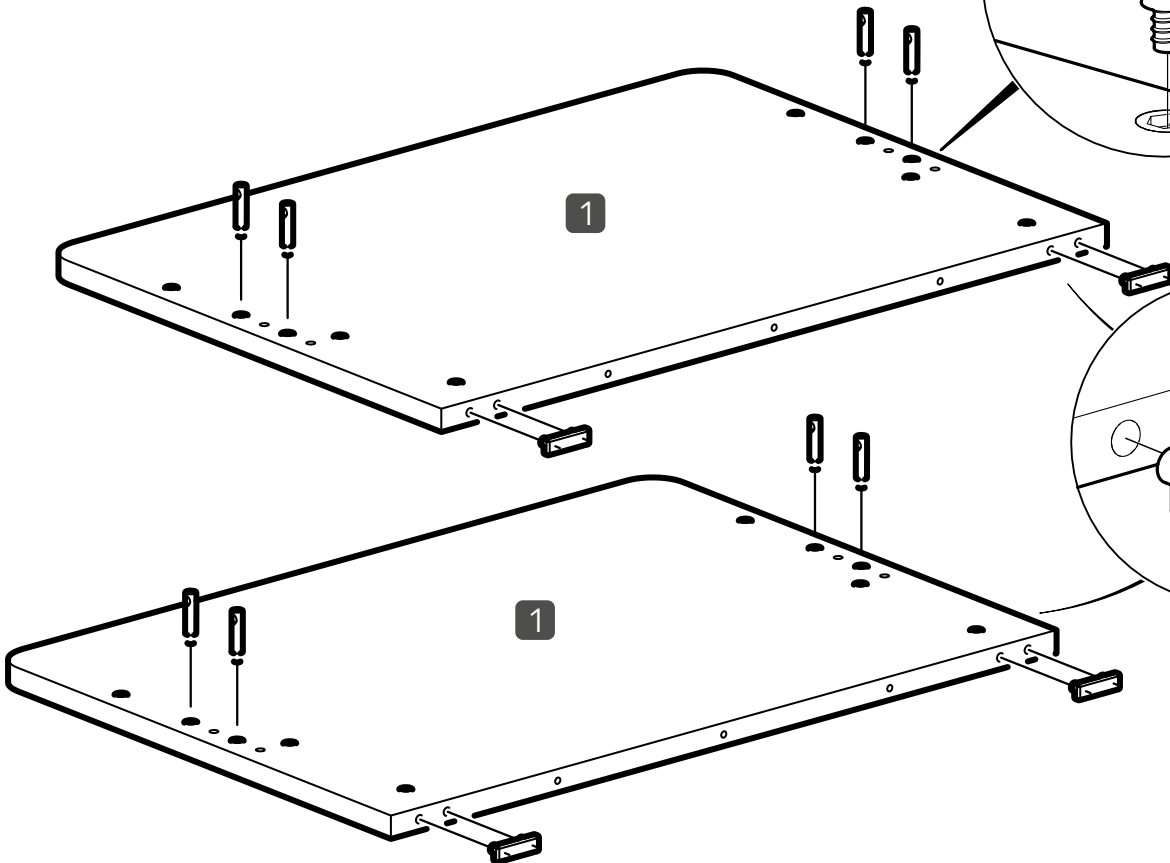
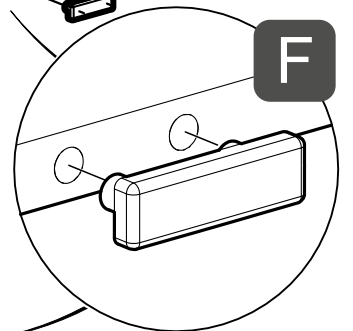
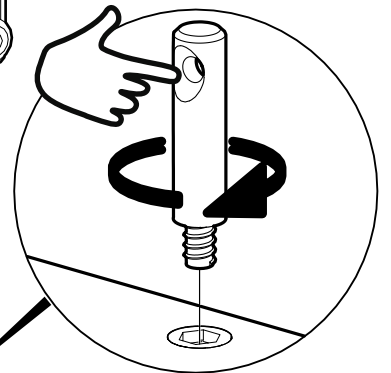
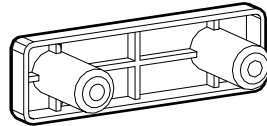

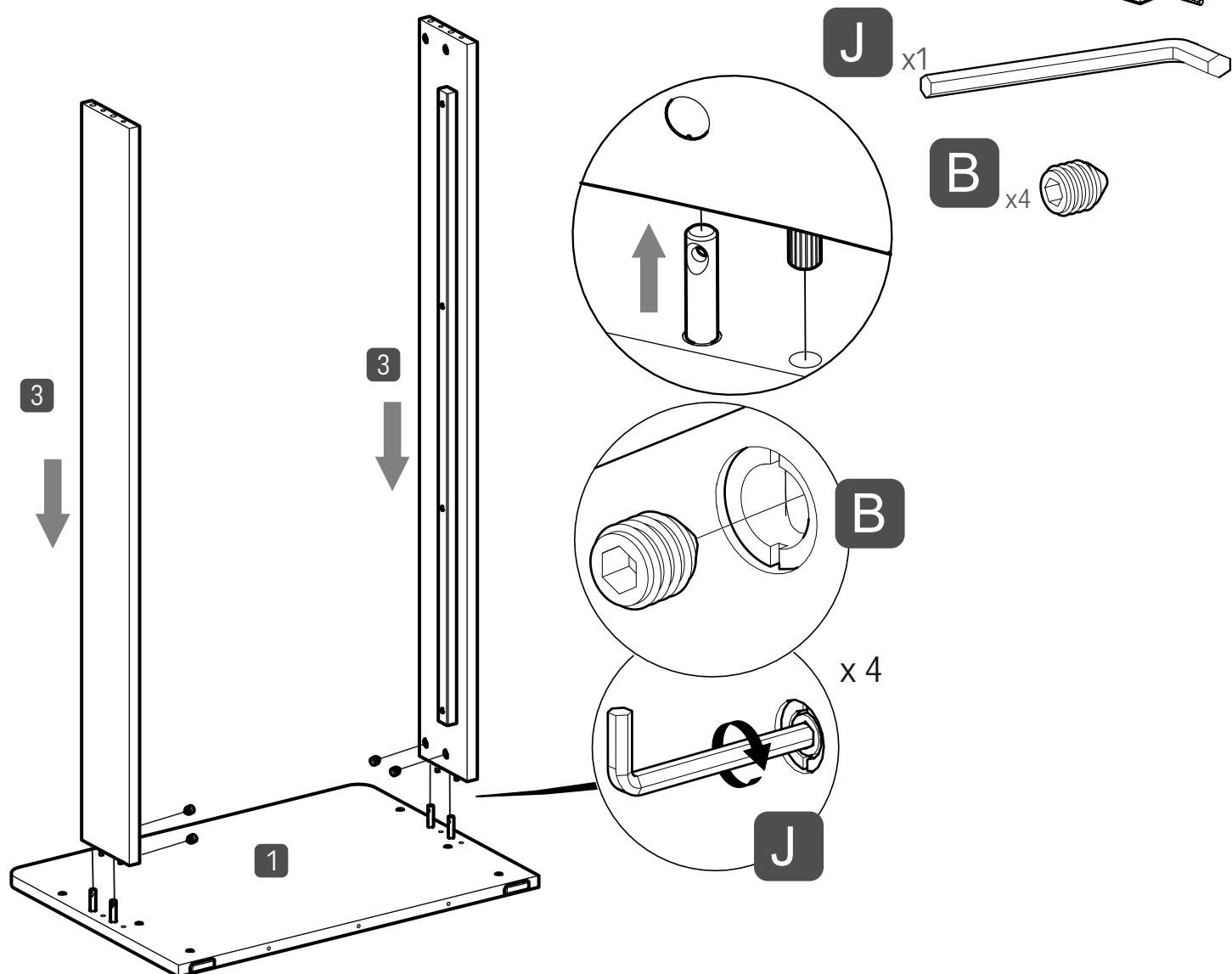
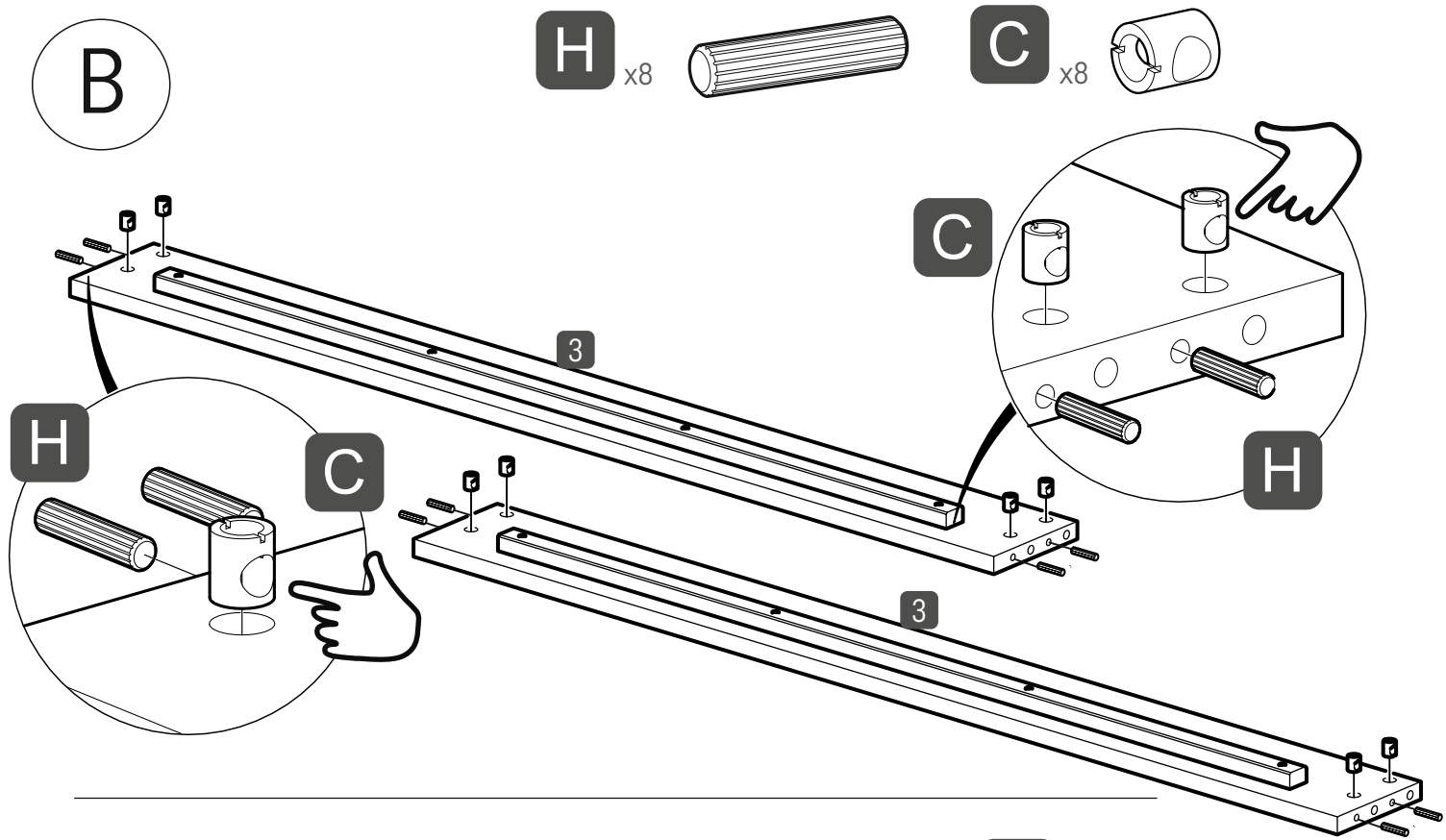

B

B x4

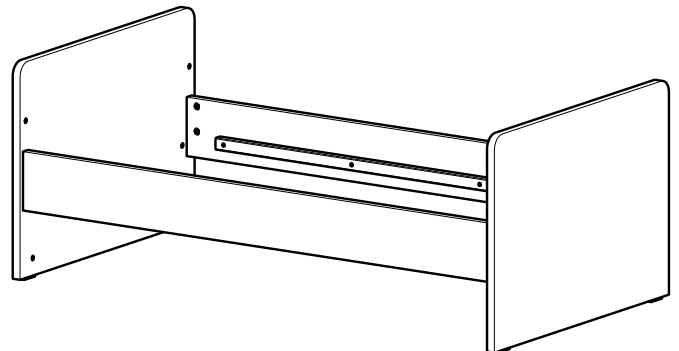
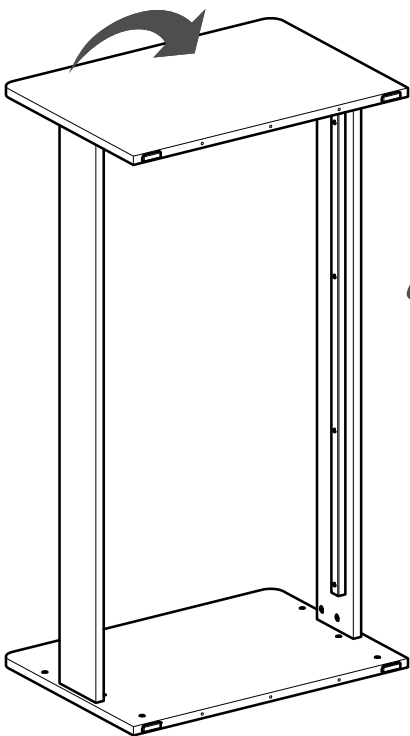
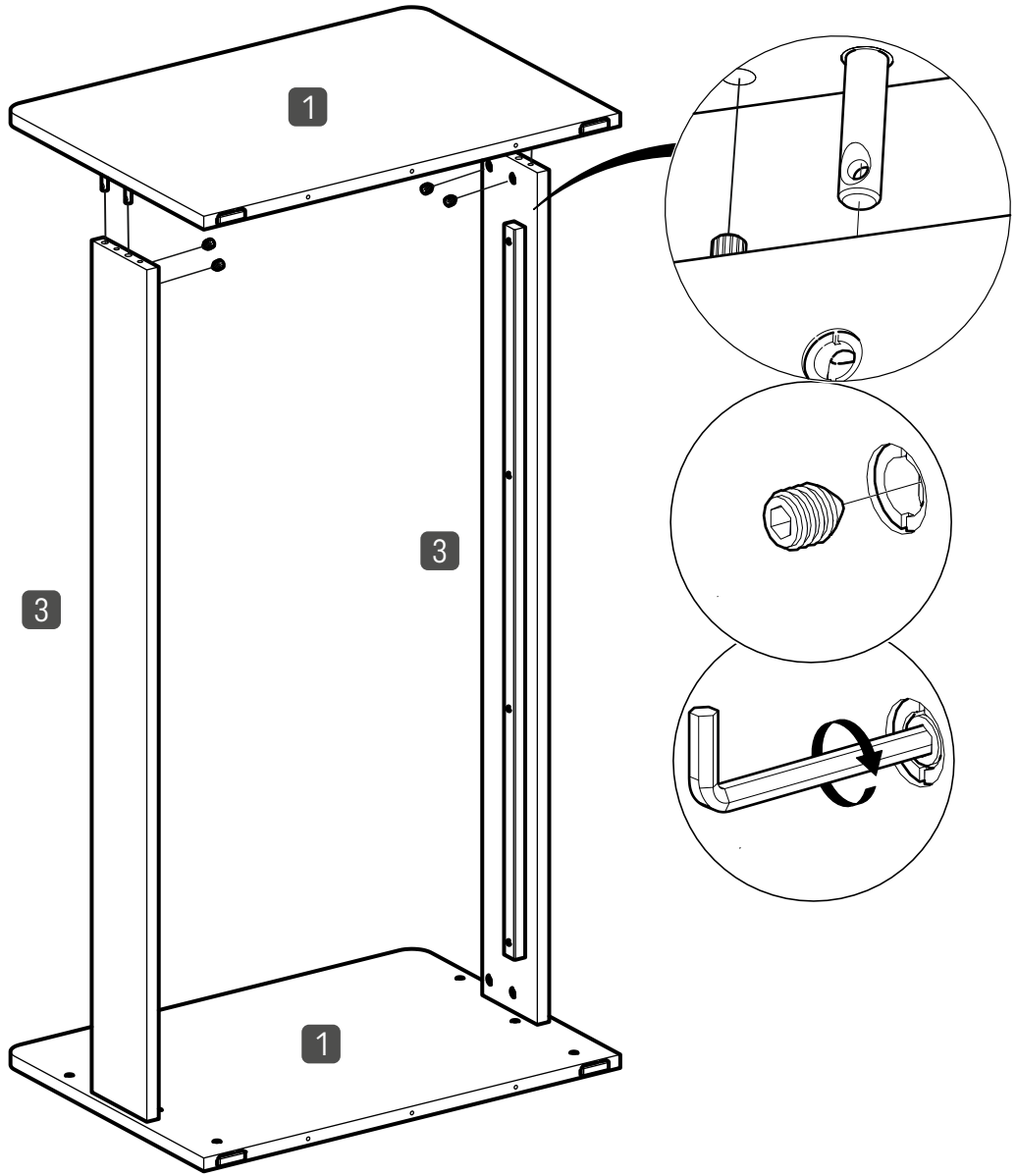

B

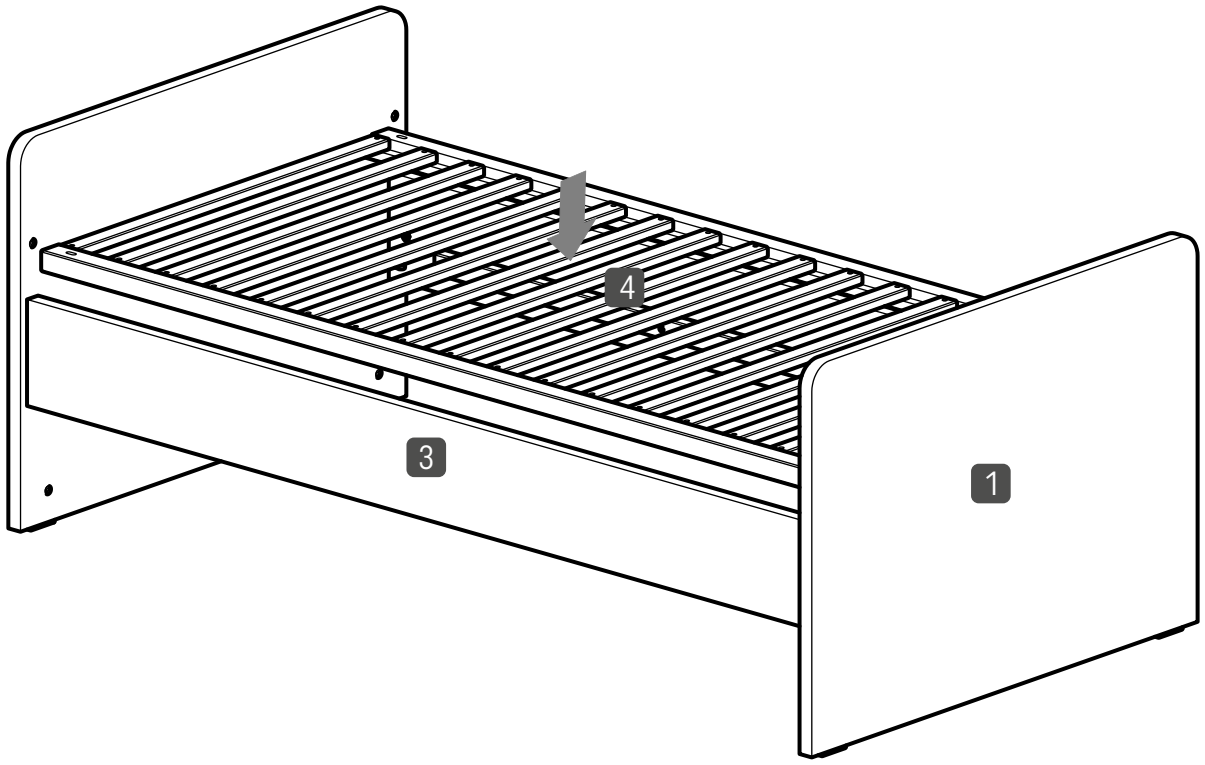



WARNING:

- Do not use the cot if any part is broken, torn or missing and use only spare parts approved by the manufacturer.
 - Be aware of the risk of open fire and other sources of strong heat, such as electric bar fires, gas fires, etc. in the near vicinity of the cot.
 - Do not leave anything in the cot or place the cot close to another product, which could provide a foothold or present a danger of suffocation or strangulation, e.g. strings, blind/curtain cords etc.
 - Do not use more than one mattress in the cot.
 - Do not place this child's bed near heat sources, windows and other furniture.
 - Do not use this child's bed if any part is broken, torn or missing.

 - The lowest position is the safest. Once your child is old enough to sit up unaided the base should be used in the lowest position.
 - The thickness of the mattress chosen shall be such that the integral height (surface of the mattress to the upper edge of the cot frame) is at least 500mm in the lowest position of the bed base and at least 200mm in the highest position of the bed base.
 - For reasons of safety, we recommend the use of the Argos cot bed mattress (1390mm x 690mm) for this cot.
 - The length and width shall be such that the gap between the mattress and the sides and ends does not exceed 30mm.
 - To prevent injury from falls, once the child is able to climb out of the cot, it should no longer be used for that child.
 - This child's bed conforms to BS8509:2008 + A1:2011.
 - When converted to a bed, this product is suitable from 18 months to 4 years
 - The mattress should be no more than 30mm shorter or narrower than the internal length or width of the cot/bed.
 - The child's bed, with the exception of the mattress base, can be dismantled for storage or transportation.
 - All assembly fittings should be tightened before use also checked periodically and re-tightened if necessary.
 - This child's bed may be cleaned with a damp cloth. Never use bleach or harsh abrasives.
 - Children are likely to play, bounce, jump and climb on beds, therefore the child's bed should not be placed too close to other furniture or windows, blind cords, curtain pulls or other strings or cords, and should be placed either tight to any wall or have a gap of 300mm between the wall and the side of the bed.
 - Do not use any additional or replacement parts other than those provided by Argos.
-

notebook

notebook



EN

Adres:

Argos Ltd. 489-499 Avebury Boulevard
Milton Keynes MK9 2NW

Telefon: 0345 640 0800

<https://www.argos.co.uk/help/contact-us/>