

Instructions for Installation and Use

Electric built-in
double oven

GB

GB

English, 2

DDD 5340 C

KDD 3340

IDD 6340

Contents

Safety Information, 2
Introduction, 3-4
Installation, 5
Tall Cabinet Ventilation, 6-7
Features, 8-9
Controls, 10-11
Multifunction Selector Switch , 12
The electronic programmer, 13
Grill Pan and Handle, 14
Operation when using the Top Oven for Grilling , 15
Conventional Grilling, 16
Operation when using the Top Oven for Grilling, 17
Using the Top Oven as a Convection Oven, 18
Operation when using the Top Oven as a Convection Oven, 19
Top Oven Cookery Notes, 20
Top Oven Temperature Charts, 21-22
Main Oven - Fan Grilling DDD 5340 C KDD 3340 , 23
Main Oven - Fan Grilling Roasting Chart , 24
Using the Main Oven for Other Functions, 25
Main Oven - Convection Oven, 26
Main Oven - Fan Oven (all Models), 27
Main Oven - Fan Oven Cookery Notes, 28-29
Main Oven Temperature Chart, 30-31
Main Oven Grilling, 32
Care and Cleaning, 33-35
If Something Goes Wrong?, 36
If it Still Won't Work/ Disposal of the appliance, 37
Guarantee Information, 38

You must read these instructions prior to using
your appliance and retain them for future use.

Safety Information

GB

- **WARNING:** The appliance and its accessible parts become hot during use.
- Care should be taken to avoid touching heating elements.
- Children less than 8 years of age shall be kept away unless continuously supervised.
- This appliance can be used by children aged from 8 years and above and persons with reduced physical, sensory or mental capabilities or lack of experience and knowledge if they have been given supervision or instruction concerning use of the appliance in a safe way and understand the hazards involved. Children shall not play with the appliance. Cleaning and user maintenance shall not be made by children without supervision
- ! When you place the rack inside, make sure that the stop is directed upwards and in the back of the cavity.
- During use the appliance becomes hot. Care should be taken to avoid touching heating elements inside the oven.
- **WARNING:** Accessible parts may become hot during use. Young children should be kept away.
- Do not use harsh abrasive cleaners or sharp metal scrapers to clean the oven door glass since they can scratch the surface, which may result in shattering of the glass
- When cleaning the appliance do not use steam cleaner.
- **WARNING:** Ensure that the appliance is switched off before replacing the lamp to avoid the possibility of electric shock
- The appliance is not intended to be operated by means of an external timer or separate remote-control system.

NOTICE

! VERY HOT SURFACES

FOOD OR GREASE ON THESE SURFACES COULD CAUSE SMOKE AND POSSIBLY EVEN BURN

YOU MUST KEEP THE OVEN AND GRILL CAVITIES CLEAN

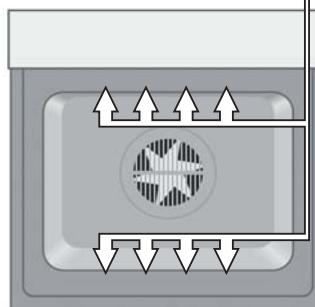

! ATTENTION

DURING INSTALLATION THE FEET OF THE APPLIANCE MUST BE LOWERED SO THAT AN AIR GAP OF AT LEAST 10MM (1CM) IS LEFT BETWEEN THE BASE OF THE APPLIANCE AND THE FLOOR.



! ATTENTION

WHEN USING THE MAIN OVEN YOU MUST ENSURE THAT THE BASE OF THE CAVITY IS NOT COVERED WITH ALUMINUM FOIL, UTENSIL OR ANY OTHER FORM OF COVERING. FAILURE TO DO THIS MAY RESULT IN THE CAVITY BEING DAMAGED.

Your new appliance is guaranteed* and will give lasting service. This guarantee is only applicable if the appliance has been installed in accordance with the installation instructions detailed in this booklet. To help make best use of your cooking equipment, please read this booklet carefully. The cooker is designed specifically for domestic use and responsibility will not be accepted for use in any other installation.

When the cooker is first used an odour may be emitted, this will cease after a period of use.

When first using the cooker ensure that the room is well ventilated (e.g. open a window or use an extractor fan) and that persons who may be sensitive to the odour avoid any fumes. It is suggested that any pets be removed from the room until the smell has ceased. This odour is due to temporary finish on oven liners and elements and also any moisture absorbed by the insulation.

*** The guarantee is subject to the provisions that the appliance:**

- (a) Has been used solely in accordance with the Users Instruction Book.**
- (b) Has been properly connected to a suitable supply voltage as stated on the rating plate attached to this equipment.**
- (c) Has not been subjected to misuse or accident or been modified or repaired by any person other than the authorised employee or agent.**
- (d) Has been correctly installed.**



Technical Characteristics

Top Oven

DDD 5340 C

KDD 3340

Usable Volume: 42Litres

IDD 6340

ENERGY LABEL AND ECODESIGN - Top Oven

Directive 2009/125/EC

Declared energy consumption for
Natural convection Class

heating mode: Conventional

Main Oven

DDD 5340 C

KDD 3340

Usable Volume: 70 Litres

IDD 6340

Usable Volume: 74 Litres

ENERGY LABEL AND ECODESIGN - Main Oven

Directive 2009/125/EC

Declared energy consumption for
Natural convection Class
heating mode: Fan Oven



Voltage and Frequency

230-240V~ 50Hz

For Your Safety

GB

When used properly your appliance is completely safe but as with any electrical product there are certain precautions that must be observed. PLEASE READ THE PRECAUTIONS BELOW BEFORE USING YOUR APPLIANCE.

Always

- Always make sure you remove all packaging and literature from inside the oven and grill compartments before switching on for the first time.
- Always make sure you understand the controls prior to using the appliance.
- Always keep children away from the appliance when in use as the surfaces will get extremely hot during and after cooking.
- Always make sure all controls are turned off when you have finished cooking and when not in use.
- Always stand back when opening an oven door to allow any build up of steam or heat to disperse.
- Always use dry, good quality oven gloves when removing items from the oven/grill.
- Always take care to avoid heat/steam burns when operating the controls.
- Always turn off the electricity supply at the wall switch before cleaning and allow the appliance to cool.
- Always make sure the shelves are in the correct position before switching on the oven.
- Always keep the oven and grill doors closed when the appliance is not in use.
- Always take care when removing utensils from the top oven when the main oven is in use as the contents may be hot.
- Always keep the appliance clean as a build up of grease or fat from cooking can cause a fire.
- Always follow the basic principles of food handling and hygiene to prevent the possibility of bacterial growth.
- Always keep ventilation slots clear of obstructions.
- Always refer servicing to a qualified appliance service engineer.
- During use the oven becomes hot. Care should be taken to avoid touching heating elements inside the oven.

SAFETY ADVICE

IN THE EVENT OF A CHIP PAN OR ANY OTHER PAN FIRE:

1. TURN OFF THE COOKER APPLIANCE AT THE WALL SWITCH.
2. COVER THE PAN WITH A FIRE BLANKET OR DAMP CLOTH, this will smother the flames and extinguish the fire.

3. LEAVE THE PAN TO COOL FOR AT LEAST 60 MINUTES BEFORE MOVING IT. Injuries are often caused by picking up a hot pan and rushing outside with it. NEVER USE A FIRE EXTINGUISHER TO PUT OUT A PAN FIRE as the force of the extinguisher is likely to tip the pan over. Never use water to extinguish oil or fat fires.

Never

- Never leave children unsupervised where a cooking appliance is installed as all cooking surfaces will be hot during and after use.
- Never allow anyone to sit or stand on any part of the appliance.
- Never store items above the appliance that children may attempt to reach.
- Never remove the oven shelves whilst the oven is hot.
- Never heat up unopened food containers as pressure can build up causing the container to burst.
- Never store chemicals, food stuffs or pressurised containers in or on the appliance, or in cabinets immediately above or next to the appliance.
- Never operate the grill with the door closed as this will cause the appliance to overheat.
- Never use the appliance as a room heater.
- Never use the grill to warm plates.
- Never dry any items on the oven doors.
- Never install the appliance next to curtains or other soft furnishings.
- Never allow children to play with the appliance controls.
- Never use 'steam cleaners'.

Children should be supervised to ensure that they do not play with the appliance.

! The appliance should not be operated by people (including children) with reduced physical, sensory or mental capacities, by inexperienced individuals or by anyone who is not familiar with the product. These individuals should, at the very least, be supervised by someone who assumes responsibility for their safety or receive preliminary instructions relating to the operation of the appliance.

! The appliance must be used by adults only for the preparation of food, in accordance with the instructions outlined in this booklet. Any other use of the appliance (e.g. for heating the room) constitutes improper use and is dangerous. The manufacturer may not be held liable for any damage resulting from improper, incorrect and unreasonable use of the appliance.

Electrical Requirements

For your own safety, we recommend that your cooker is installed by a competent person such as one who is registered with NICEIC (National Inspection Council for Electrical Installation Contracting). The cooker should be installed in accordance with the latest edition of the IEE Regulations.

Warning: This appliance must be earthed.

Electrical Connections

The installer must check that the voltage shown on the rating plate corresponds with the house electricity supply. The cooker must be supplied via a suitable double pole isolating switch, having a contact separation of at least 3mm in all poles placed in a readily accessible position adjacent to the cooker. If the cooker is to be wired into a connector unit, this may be positioned behind the cooker providing the following requirements are met:

- i) The connector unit must not project from the wall more than 25mm.
- ii) The top of the connector must not be more than 130mm above floor level.

Remove the terminal cover at the rear base of the cooker. Pass the cable through the cable clamp and connect to the appropriate terminals provided. Allow sufficient cable for any future servicing. Tighten the screws on the cable clamp and replace the cover. Make main connections in the connector unit or cooker control unit. This appliance conforms to B.S. EN 55014 regarding suppression of Radio and Television reception interference.

A double Pole control switch having a minimum rating of 32 amps should be used to feed the cooker using a suitably rated cable. Where a hob is fitted adjacent to or over the cooker, a 45 amp Double Pole control switch should be used to feed both units via separate suitably rated cables.

We recommend a minimum of 4mm² PVC insulated twin and earth cable conforming to B.S. 6004 for connection of each appliance.

In all cases adhere to routing details (see fig. 4).

This appliance must not be installed over any other appliance that generates heat such as a plinth heater.

Note: Due to many different types of installation, a mains cable is not supplied with this product. The installer will fit the correct type and length of cable.

Important

It is essential that the lower cupboard is constructed in the manner illustrated i.e. having side, back, and roof panels so joined as to provide no apertures which could permit access to the oven unit when installed.

1. General

The appliance is designed for mounting at a safe level into an oven housing which must be secured to the backing wall.

2. Ventilation

- a. The oven housing unit cabinet dimensions must comply with fig. 4.
- b. An air gap of 50mm minimum must be provided at the rear of any top or bottom cupboards or shelves (see fig. 1).
- c. It is necessary that the cabinets are provided with unobstructed ventilation, i.e. from adjacent cabinetry. This can be done by either raising the base of the cabinets using the adjusting feet (or spacers) or alternatively by providing a slot in the cabinet plinth to the dimensions in fig. 1.
- d. The air gap at rear allows the warmed air to pass out of the inner cabinet space. Where it is intended to fit cupboards above the oven unit to ceiling height, it is essential that the warmed air is exhausted through the front of the cabinet (see fig. 1).
- e. If an oven unit is installed adjacent to a tall cabinet, steam escaping from the oven when the door is opened could condense on and maybe stain the adjacent surface. To prevent permanent staining, the adjacent surface should be made of a material that is heat resisting and easy to clean. Adjacent tall cabinets should not be deeper than the oven housing cabinet.

3. Final Installation

- a. Using a spirit level, check that the housing cabinet is level from side to side and from front to back in its installed position.
- b. Correct any unevenness by placing spacers under the bottom of the cabinet. Make sure that the cabinet rests firmly on the floor without rocking.
- c. Before the oven is fitted, the cabinet must be firmly secured to the backing wall for stability.
- d. The oven unit should now be lifted (this is a two person lift) into the cabinet and pushed fully home.
- e. Finally, the oven is secured to the cabinet by means of the four Phillips C/SK Head screws - two through each side trim.
- f. Remove all packaging material from the grill and oven interior.

List of loose items:

4 x Phillips C/SK Head No. 6 x 25mm screws.

Tall Cabinet Ventilation

GB

Fig. 1

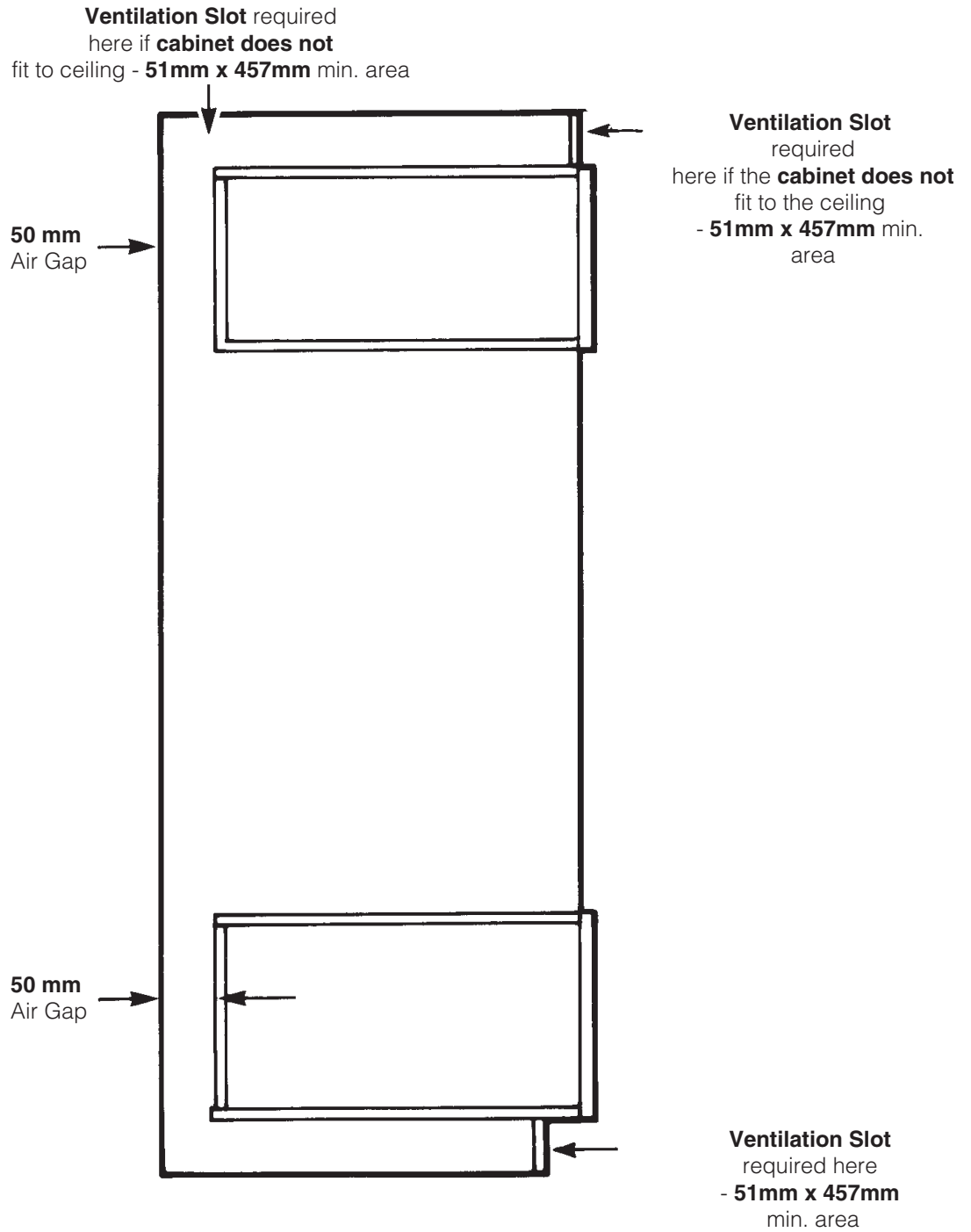

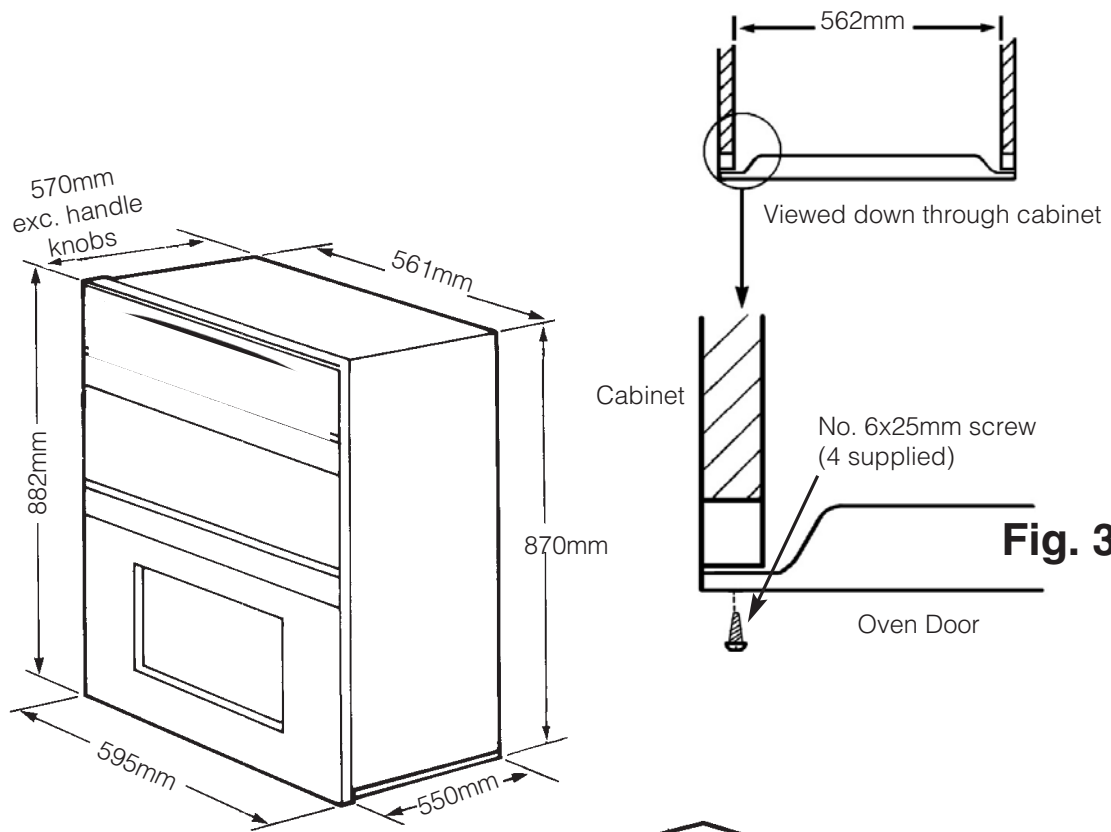

Fig. 2

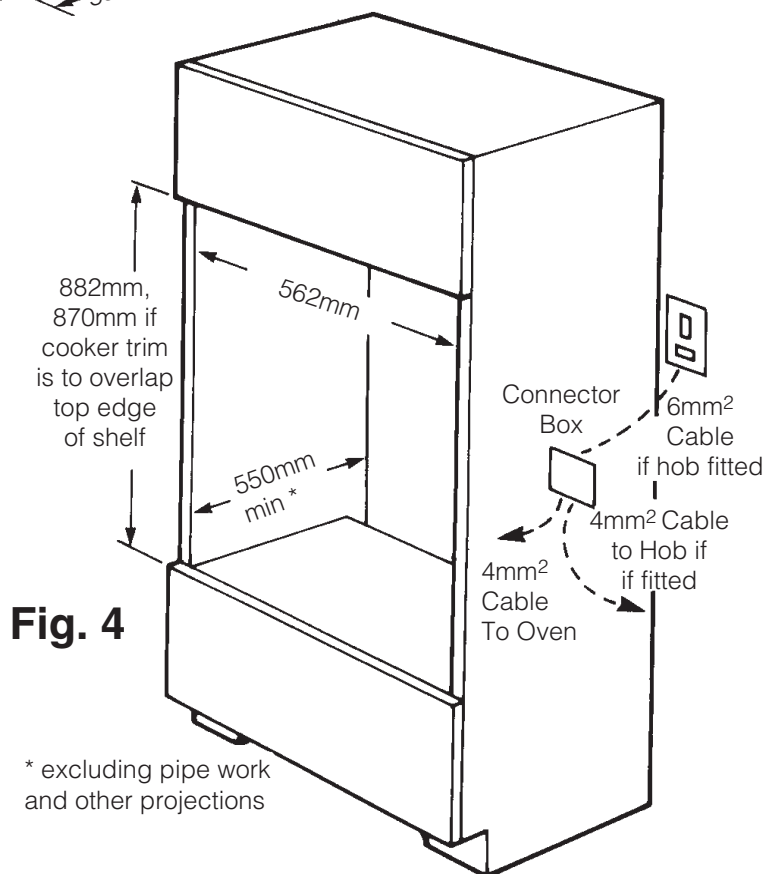

Fig. 4

Features

IDD 6340

GB

WARNING: DO NOT TOUCH THE GLASS DOORS WHEN THE OVEN IS IN USE AS THESE AREAS CAN BECOME HOT.

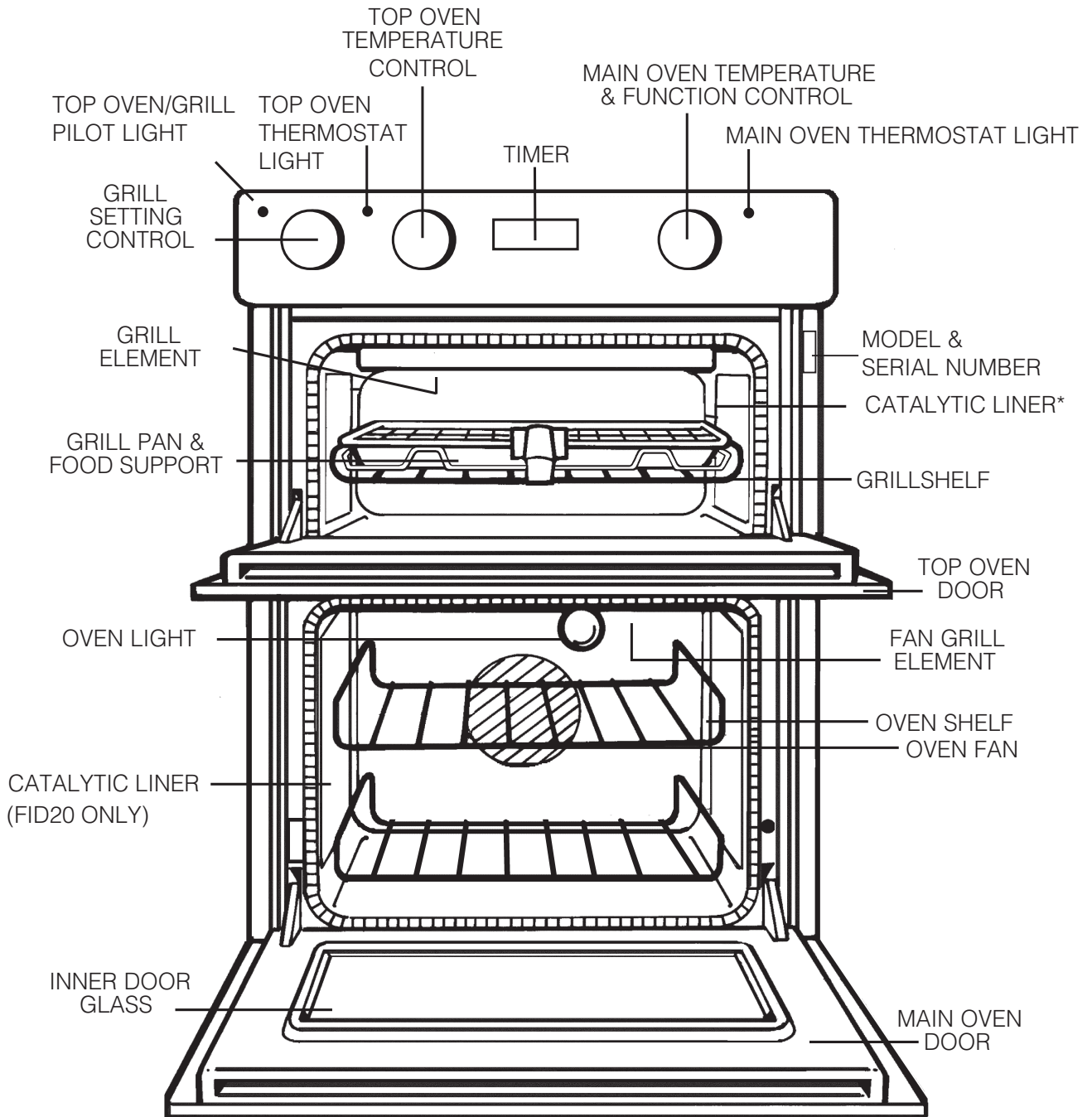

NEVER line the shelves, floor or sides of the oven or grill with aluminium foil as overheating and damage may result.

* Only on certain models

DDD 5340 C KDD 3340

WARNING: DO NOT TOUCH THE GLASS DOORS WHEN THE OVEN IS IN USE AS THESE AREAS CAN BECOME HOT.

GB

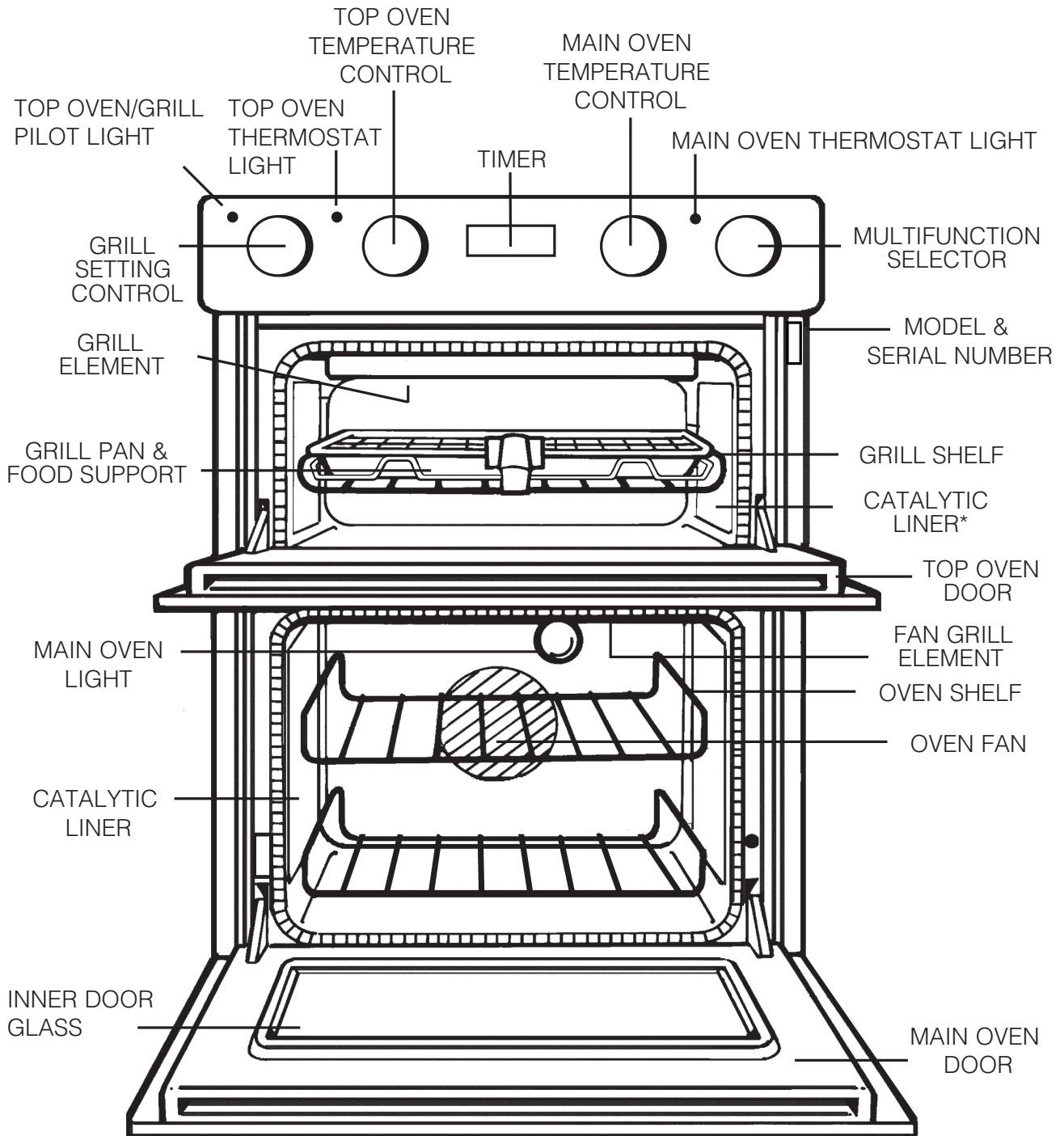





NEVER line the shelves, floor or sides of the oven or grill with aluminium foil as overheating and damage may result.

* Only on certain models

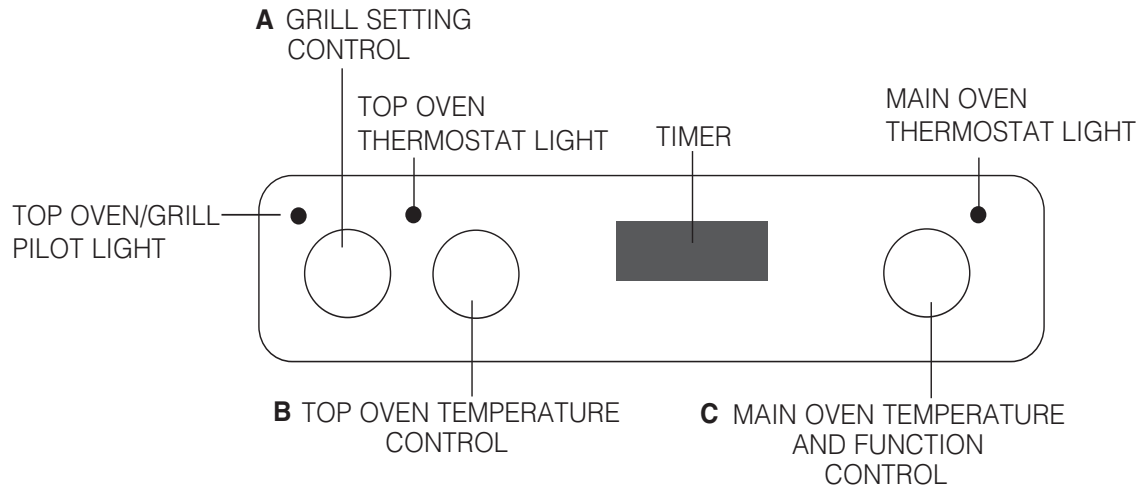
IDD 6340

GB



Control Knob	Description	Function
A	Grill Setting Control	Selects the heat at which the grill will cook the food. min - max Grill Control Settings: Min = Low, Max = High
B	Top Oven Temperature Control	 Selects the cooking temperature (Degrees Centigrade) when using the top oven as a conventional oven.
C	Main Oven Temperature & Function Control	 Fan Only Setting - This is used to decrease the amount of time required to defrost food items.  Oven Light Only - Switches on the Main Oven Interior Light Only  Main Oven Temperature Scale (In Degrees Centigrade). - When cooking select the required cooking temperature.

Cooling Fan

A gentle flow of air will be blown below the control panel when the grill control is used and after a short period of time when the ovens are used.

Note: Whenever the appliance has been used, the cooling fan may run on or restart itself after all the controls have been turned off. This indicates that the appliance is still warm.

Oven Interior Lights

The oven lights are operated when their respective oven control is used.

(**N.B.** Not all models have a top oven interior light). The main oven has a light only position.

Slow Cooking

The main oven has a "Slow Cook Setting" this can be used for slow cooking, keeping food warm and warming plates for a short period.

Note: It is advisable to check that all oven controls have been switched off when you have finished using the appliance.

Controls

DDD 5340 C KDD 3340

GB

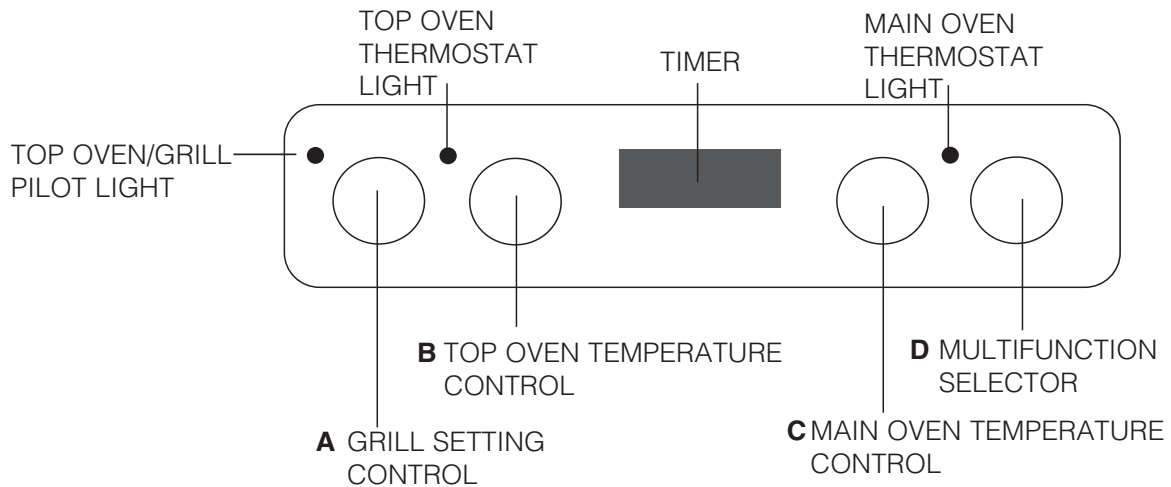

IMPORTANT

Before using your oven in the ordinary way, **ALWAYS** make sure that the timer has been set to **MANUAL** operation. Unless this is done, the main oven cannot heat up. Before seeking assistance, make sure this is done (refer to oven timer operation).

MULTIFUNCTION SELECTOR

Rotate the control knob in either direction to the required function. Many of the functions will also require the main oven thermostat to be set before the oven will heat up.

MAIN OVEN TEMPERATURE CONTROL

This is used in addition to the multifunction selector. This is used for the functions: fan oven, fan grill, half grill and full grill and convection oven.

Turn the control clockwise to set the oven thermostat to the required temperature.

If the timer is set correctly and the selector switch set to a suitable function an indicator light will illuminate (Fan Oven, Convection Oven and Fan Grilling modes only). This will remain on until the oven reaches the required temperature. This light will then cycle on and off as the thermostat maintains control of the oven temperature.

TOP OVEN TEMPERATURE CONTROL

Turn the control clockwise to set the top oven thermostat to the required temperature. An indicator light will illuminate. This will remain on until the oven reaches the required temperature. This light will then cycle on and off as the thermostat maintains control of the oven thermostat.

GRILL CONTROL

The grill control is designed to provide variable heat control of either both grill elements on together or the single left-hand grill element only.

To set the grill power, turn the grill control:

- clockwise for **FULL** grill to any setting MIN - MAX, or
- anti-clockwise for **HALF** grill to any setting MIN - MAX.

COOLING FAN

A gentle flow of air will be blown below the control panel when the grill control is used and after a short period of time when the ovens are used.

Note: Whenever the appliance has been used, the cooling fan may run on or restart itself after all the controls have been turned off. This indicates that the appliance is still warm.

Multifunction Selector Switch

DDD 5340 C KDD 3340

GB

The Multifunction selector switch is used when operating the main oven.

With the exception of the **O** position the main oven light will remain on when this selector switch is used.

Off 0

With the selector in this position the main oven will not heat up. The timer will still operate.

Fan Oven

The oven fan and a rear element are controlled when this function is selected.

Use the main oven thermostat control to set the required temperature.

Conventional Oven

Top and base elements are controlled when this function is selected.

Use the main oven thermostat to set the required temperature.

Half Grill

With this function selected both sides of the grill will be on, but the outer element is switched off.

Use the oven thermostat control to set the required temperature.

Oven door must be open for grilling.

Full Grill

Both left and right hand grill elements will be on in this position.

Use the oven thermostat control to set the required temperature.

Oven door must be open for grilling.

Fan Grill

The oven fan and fan grill element are controlled when this function is selected.

Use the oven thermostat control to set the required temperature.

Oven door must be closed for fan grilling.

Fan Only

The oven fan will operate when this function is selected.

The oven thermostat control must be set in the off position.

Light Only

This function switches on the oven light only.

! After selecting any of the oven programs, the parameter setting of the product is activated. It optimizes the performance of cooking, but could result in a delayed ignition of fan and heating elements.

The electronic programmer

GB

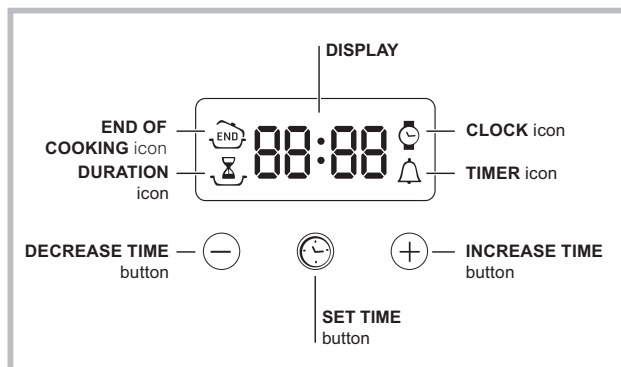

! The Main Oven (only) can be controlled by the automatic timer.



! Never operate the grill or top oven when the main oven is set to cook automatically because the oven cavity can become warm and this may cause bacterial growth in food.

Setting the clock

! The clock may be set when the oven is switched off or when it is switched on, provided that the end time of a cooking cycle has not been programmed previously.



After the appliance has been connected to the mains,

or after a blackout, the  icon and the four numerical digits on the DISPLAY will begin to flash.

1. Press the  button several times until the  icon and the four digits on the display begin to flash.
2. Use the "+" and "-" buttons to adjust the time; if you press and hold either button, the display will scroll through the values more quickly, making it quicker and easier to set the desired value.
3. Wait for 10 seconds or press the  button again to finalise the setting.

Setting the minute minder

! This function does not interrupt cooking and does not affect the oven; it is simply used to activate the buzzer when the set amount of time has elapsed.



1. Press the  button several times until the  icon and the three digits on the display begin to flash.
2. Use the "+" and "-" buttons to set the desired time; if you press and hold either button, the display will scroll through the values more quickly, making it quicker and easier to set the value.
3. Wait for 10 seconds or press the  button again to finalise the setting.

The display will then show the time as it counts down. When this period of time has elapsed the buzzer will be activated.

Programming cooking





! A cooking mode must be selected before programming can take place.

Programming the cooking duration

1. Press the  button several times until the  icon and the three digits on the DISPLAY begin to flash.
2. Use the "+" and "-" buttons to set the desired duration; if you press and hold either button, the display will scroll through the values more quickly, making it quicker and easier to set the value.
3. Wait for 10 seconds or press the  button again to finalise the setting.
4. When the set time has elapsed, the text END appears on the DISPLAY, the oven will stop cooking and a buzzer sounds. Press any button to stop the buzzer and turn all control knobs to the 0 position.
 - For example: it is 9:00 a.m. and a time of 1 hour and 15 minutes is programmed. The programme will stop automatically at 10:15 a.m.

Setting the end time for a cooking mode

! A cooking duration must be set before the cooking end time can be scheduled.

1. Follow steps 1 to 3 to set the duration as detailed above.
2. Next, press the  button until the  icon and the four digits on the DISPLAY begin to flash.
3. Use the "+" and "-" buttons to adjust the cooking end time; if you press and hold either button, the display will scroll through the values more quickly, making it quicker and easier to set the desired value.
4. Wait for 10 seconds or press the  button again to finalise the setting.
5. When the set time has elapsed, the text END appears on the DISPLAY, the oven will stop cooking and a buzzer sounds. Press any button to stop it. Programming has been set when the  and  buttons are illuminated. The DISPLAY shows the cooking end time and the cooking duration alternately.
 - For example: It is 9:00 a.m. and a duration of 1 hour has been programmed. 12:30 is scheduled as the end time. The programme will start automatically at 11:30 a.m.

Cancelling a programme

To cancel a programme:

- press the  button until the icon corresponding to the setting you wish to cancel and the digits on the display are flashing. Press the "-" button until the digits 00:00 appear on the display.
- Press and hold the "+" and "-" buttons; this will cancel all the settings selected previously, including timer settings.

GB

Using the grill pan kit

The grill pan handle is detachable from the pan to facilitate cleaning and storage. Fix the pan handle securely before use:

1. Fit the handle to the grill pan so that the external 'hooks' embrace the edge of the pan (fig. 1)
2. Make sure that the middle part of the handle fits exactly the protruding support of the pan (fig. 2) and holds the pan from the bottom.

The food must be placed on the rack in the grill pan. Position the grill pan on top of the oven rack. The best results are achieved by placing the oven rack on the uppermost shelves. Pouring a little water into the grill pan will make the collection of grease particles more efficient and prevent the formation of smoke.

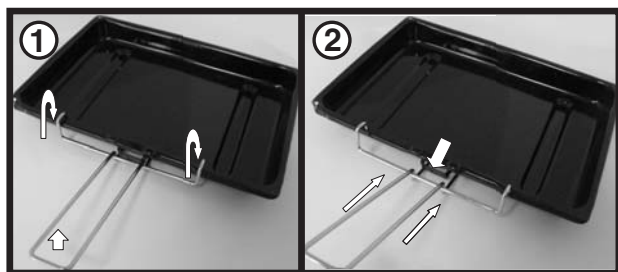

Grill Pan, Food Support

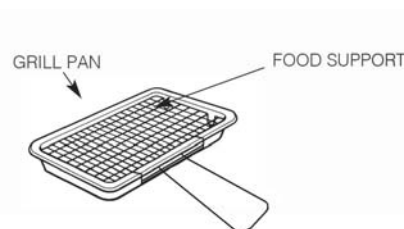

Top Oven Shelf Positioning for Grilling

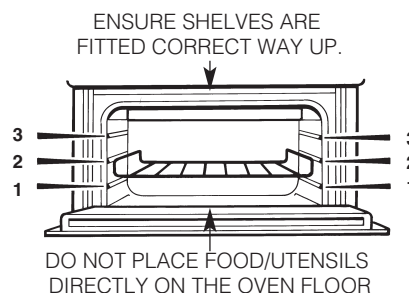

NOTE:

- Preheat the grill if indicated on grill chart.
- The grill pan must be placed on the correct shelf and positioned centrally under the grill element.
- Leave the control at MAX for toast, and for fast cooking of foods.
- For thicker foods requiring longer cooking, turn the switch to a lower setting after the initial sealing on both sides at MAX. The thicker the food, the lower the control should be set.
- DO NOT line the grill pan with aluminium foil, as this increases the amount of fat spitting which can cause a fire.
- After use always return the grill control to the OFF (0) position.

Operation when using the Top Oven for Grilling

IDD 6340

GB

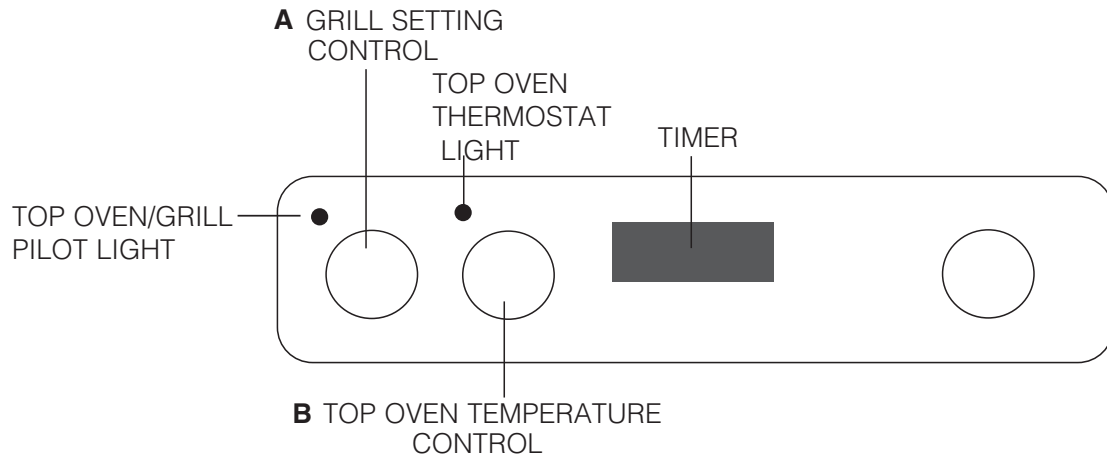

- Step 1** Ensure that the timer is set to manual.
- Step 2** Place the grill pan runner/support in the correct position (see Grilling Guide). Locate the grill pan in the runner/support, position centrally under the grill element. Leave the door fully open.
- Step 3** Turn knob (A) clockwise for FULL grill or anti-clockwise for HALF grill, to select the Grill Setting (min-max):
(MIN = Low, MAX = High)

Grill Controls Example:

MAX = Maximum Grill Setting.

NOTE: Do not grill with the grill/top oven door closed.

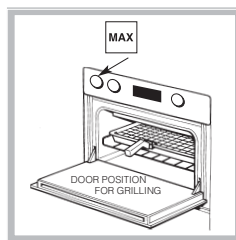

- Step 4** After use, turn the grill control (A) to the off position (●).

! The Top oven/Grill Pilot Light is on when grill is used.

! Ensure knob (B) is in "0 position". The grill and the top oven cannot work simultaneously

DO NOT allow young children near to the appliance when the grill is in use as the surfaces get extremely hot.

GB

CAUTION - ACCESSIBLE PARTS MAY BECOME HOT WHEN THE GRILL IS IN USE. CHILDREN SHOULD BE KEPT AWAY. GRILLING SHOULD NEVER BE UNDERTAKEN WITH THE GRILL/TOP OVEN DOOR CLOSED.

The grill control is designed to provide variable heat control, either turning the control clockwise for the twin grill elements on together or turning anti-clockwise for the single, left hand grill element only. You can select a power level of **MIN** through to **MAX**, in both directions.

The control is **Off** at **O**.

Note: The grill will not operate unless the top oven control is in the OFF position.

Food which requires browning only should be placed under the hot grill, directly on the shelf in the first or second runner from the bottom of the oven, according to the depth of the dish. Open the grill door to the grilling position, ie. open fully. With the grill door in the grilling position, heating the grill is achieved by turning the control clockwise to the desired 'grill setting' on the control panel, as described under 'setting the grill'.

Never: Line the grill pan with aluminium foil.

Note:

A gentle flow of air will be blown from underneath the controls by the coolong fan when the grill is in use and will continue to do so for a length of time even after the controls have been turned off.

Preheat the grill at setting **MAX** for approximately **5** minutes. The grill pan is placed on the shelf and should be correctly positioned under the grill element. Leave the control at **MAX** for toast, sealing and fast cooking of foods. For thicker foods requiring longer cooking, turn the switch to a lower setting after the initial sealing on both sides at **MAX**. The thicker the food, the lower the control should be set.

Operation when using the Top Oven for Grilling

DDD 5340 C KDD 3340

GB

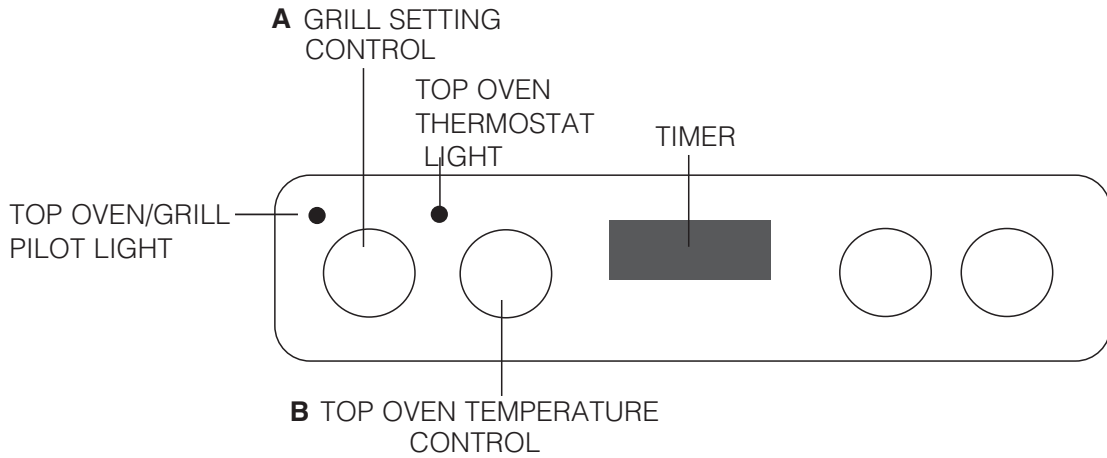

- Step 1** Ensure that the timer is set to manual.
- Step 2** Place the shelf in the correct position (see Grilling Guide). Place the food/grill pan on the shelf, position centrally under the grill element. Leave the door fully open.
- Step 3** Turn knob (A) clockwise for FULL grill or anti-clockwise for HALF grill, to select the Grill Setting:
(MIN = Low, MAX = High)

Grill Controls Example:

MAX = Maximum Grill Setting.

NOTE: Do not grill with the grill/top oven door closed.

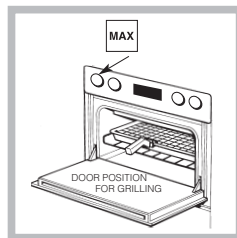

- Step 4** After use, turn the grill control (A) to the off position (•).

! The Top oven/Grill Pilot Light is on when grill is used.

! Ensure knob (B) is in "0 position". The grill and the top oven cannot work simultaneously

DO NOT allow young children near to the appliance when the grill is in use as the surfaces get extremely hot.

Using the Top Oven as a Convection Oven

GB

The top oven should be used to cook small quantities of food. The oven is designed so that the grill element operates at a reduced heat output, this is combined with a heating element situated underneath the floor of the oven. To ensure even cooking of the food it is important that cooking utensils are positioned correctly on the oven shelf so that the element is directly above. As a guide, the front of the utensil should be approx. 100mm (4") from the front of the shelf.

Note: Charts are a guide only, to suit personal taste and requirements, it may be necessary to increase or decrease temperatures by 10°C. It may also be necessary to increase or decrease cooking times.

SHELF POSITIONING

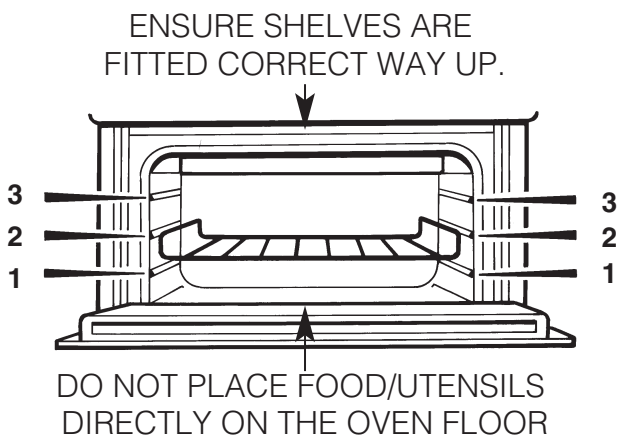

There should always be at least 25mm (1 inch) between the top of the food and the grill element.

WARNING: Items stored in the top oven will get hot when the main oven is in use.

DO NOT allow young children near to the appliance when the top oven is in use as the surfaces get extremely hot.

Operation when using the Top Oven as a Convection Oven

GB

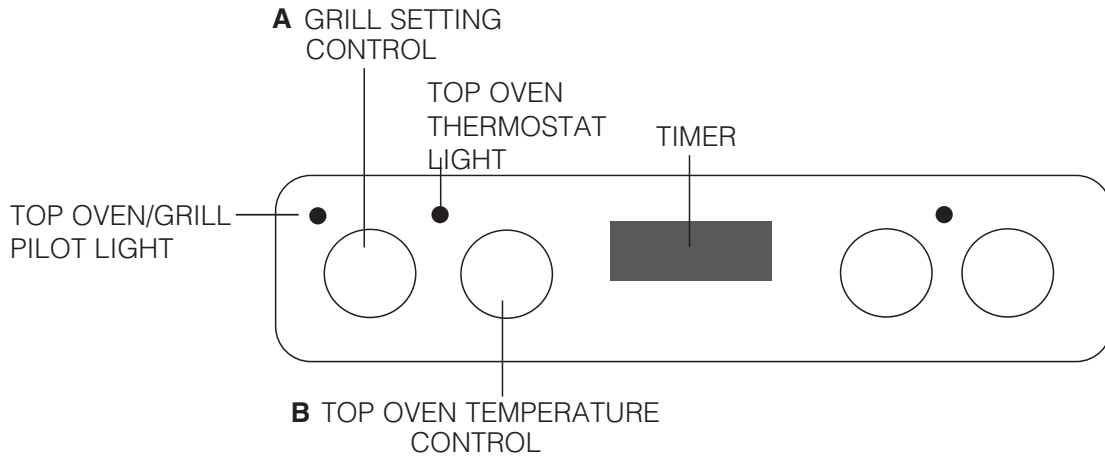

- Step 1** Ensure that the timer is set to manual.
- Step 2** Place the shelf in the correct position (see Oven Temperature Charts).
- Step 3** Select the required cooking temperature (100°C-Max) using control (B) (see Top Oven Temperature Charts). The pilot light will immediately come on, and remain on until the oven reaches the required temperature. The thermostat light will then automatically go off and on during cooking as the oven thermostat maintains the correct temperature.
- Step 4** Place the food centrally on the shelf below the element ensuring the oven door is closed.

! The Top oven/Grill Pilot Light is lit when top oven is used.

NOTE: At the end of your cooking, always return control (B) to the OFF (O) position.

GB

PLATE WARMING

Place the plates/dishes on shelf position 1 from the base of the top oven, and turn top oven temperature control (B) to 100°C for 10-15 minutes.

Never use the grill setting control (A) when warming plates.

TOP OVEN UTENSILS

Do Not use: Meat Pans and Baking Trays larger than - 225mm x 300mm (9"x12")

DO NOT use the grill pan as a meat pan in the top oven, as the air circulation will be seriously restricted.

Oven Temperature Charts - Baking

	Top Oven Cooking			
Baking	Pre-heat	Temperature °C	Time in mins.	Position in Oven
Scones	Yes	210/220	10-15	Runner 2 from bottom of oven
Small Cakes	Yes	180/190	20-25	Runner 2 from bottom of oven
Victoria Sandwich	Yes	170/180	20-30	Runner 2 from bottom of oven
Sponge Sandwich (fatless)	Yes	180/190	20-25	Runner 2 from bottom of oven
Swiss Roll	Yes	200/210	10-15	Runner 2 from bottom of oven
Semi-rich Fruit cakes	Yes	150/160	60-75 7 inch	Runner 1 or 2 from bottom of oven
Rich Fruit Cakes	Yes	140/150	Time Dependent on size	Runner 1 or 2 from bottom of oven
Shortcrust Pastry	Yes	190/200	Time Dependent on recipe	Runner 1 or 2 from bottom of oven
Puff Pastry	Yes	200/210	Time Dependent on recipe	Runner 1 from bottom of oven
Yorkshire Pudding	Yes	190/200	30-40	Runner 1 or 2 from bottom of oven
Individual Yorkshire Pudding	Yes	200/210	20-30	Runner 1 from bottom of oven
Milk Pudding	Yes	140/150	90-120	Runner 1 from bottom of oven
Baked Custard	Yes	150/160	40-50	Runner 1 from bottom of oven
Bread	Yes	200/210	30-45	Runner 1 from bottom of oven
Meringues	Yes	100	150-180	Runner 2 from bottom of oven

	Fan Oven Cooking		
Baking	Pre-heat	Temperature °C	Time in mins.
Scones	Yes	210/220	9-12
Small Cakes	No	170/180	15-20
Victoria Sandwich	No	160/170	20-25
Sponge Sandwich (fatless)	Yes	190/200	15-20
Swiss Roll	Yes	190/200	10-15
Semi-rich Fruit cakes	No	140/150	1¼ - 1½ hrs
Rich Fruit Cakes	No	130/140	Depending on size
Shortcrust Pastry	No	190/200	Depending on size
Puff Pastry	No	190/200	Depending on size
Yorkshire Pudding	Yes	180/190	40-45
Individual Yorkshire Pudding	Yes	190/200	20-25
Milk Pudding	No	130/140	1½ - 2 hrs
Baked Custard	No	140/150	35-45
Bread	Yes	200/210	30-35
Meringues	No	80-90	3 - 4 hrs

Note: If soft margarine is used for cake making, temperatures recommended by the manufacturers should be followed. Temperatures recommended in this chart refer to cakes made with block margarine only.

Oven Temperature Charts - Meat

GB

Top Oven Cooking				
Meat	Pre-heat	Temperature °C	Time (approx.)	Position in Oven
Beef/ Lamb (slow roasting)	Yes	170/180	35 mins per 450g (1lb) + 35 mins over.	Runner 1 from bottom of oven.
Beef/ Lamb (foil covered)	Yes	190/200	35-40 mins per 450g (1lb)	
Pork (slow roasting)	Yes	170/180	40 mins per 450g (1lb) + 40 mins over	
Pork (foil covered)	Yes	190/200	40 mins per 450g (1lb)	
Veal (slow roasting)	Yes	170/180	40-45 mins per 450g (1lb) + 40 mins over	
Veal (foil covered)	Yes	190/200	40-45 mins per 450g (1lb)	
Poultry/Game (slow roasting)	Yes	170/180	25-30 mins per 450g (1lb) + 25 mins over	
Poultry/Game (foil covered)	Yes	190/200	25-30 mins per 450g (1lb)	
Casserole Cooking	Yes	150	2-2½ hrs	

If using aluminium foil, never:
1. Allow foil to touch sides of oven. **2.** Cover oven interior with foil. **3.** Cover shelves with foil.

Main Fan Oven Cooking			
Note: Up to two shelves may be used in this oven. The position of these is not important providing they are evenly spaced.			
Food	Pre-heat	Temperature °C	Time (approx.)
Beef	No	160/180	20-25 mins per 450g (1lb) + 20 mins extra.
Lamb	No	160/180	25 mins per 450g (1lb) + 25 mins extra.
Pork	No	160/180	25 mins per 450g (1lb) + 25 mins extra.
Veal	No	160/170	25-30 mins per 450g (1lb) + 25 mins extra
Chicken/Turkey up to 4kg (8lb)	No	160/180	18-20 mins per 450g (1lb) + 20 mins extra.
Turkey up to 5.5kg (12lb)	No	150/160	13-15 mins per 450g (1lb) eg. 5kg (11lb) = 143-165 mins
Turkey over 5.5kg (12lb)	No	150	12 mins per 450g (1lb) e.g. 10kg (22lb) = 264 mins
Casserole Cooking	No	140/150	1½ - 2 hrs

The most accurate method of testing the readiness of joints of meat or whole poultry is to insert a meat thermometer into the thickest part of a joint, or the thickest part of poultry thighs, during the cooking period. The meat thermometer will indicate when the required internal temp has been reached.

Beef - Rare: 60°C **Lamb:** 80°C **Poultry:** 90°C
 Medium: 70°C **Pork:** 90°C
 Well Done: 75°C **Veal:** 75°C

Main Oven - Fan Grilling

DDD 5340 C KDD 3340

GB

Fan grilling is a combination of heat from the grill element and the oven fan circulating the hot air around the food.

Joints of meat and poultry will be browned as if they were cooked on a rotisserie or spit but more economically as the door left closed.

If required, fan grilling can be timed using the Oven Auto timer.

Follow the timer instructions before selecting fan grill and the required temperature.

If Manual fan grilling is required always ensure the timer is set to Manual.

Operating Instruction

1. Open the oven door.
2. Select the correct shelf position, as stated in chart.
3. Turn the selector switch to the Fan grill position.
4. Turn the oven thermostat control to the required temperature (see Fan Grilling Roasting Chart, next page).
5. Position the meat pan centrally under the grill elements (if available).
6. Close the oven door.
7. After use always return both controls to the off position.
8. If the oven timer was used, reset to Manual.

As with the fan oven cooking there is no need to pre-heat the oven - yet another economy feature. Also you can cook more than one thing at a time - even up to 4 small chickens.

Temperatures

These will be similar to those used for the more traditional form of roasting but the guide will give you an indication of which temperature to set the Thermostat. But remember that because of the way the oven is heated this is a more economical way of roasting.

General Recommendations

Most types of meat and poultry cooked by this method will have an all over brownness and crispness on the outside. The only exceptions are very lean joints, such as veal, which, because of its low fat content, is better cooked using conventional heating.

1. Always place the pan on the shelf position recommended. (See Chart).
2. There is no need to preheat the oven before cooking and all fan grilling should be carried out with the oven door closed, this saves energy. The cooking temperatures and times are calculated from a cold oven.
3. Position meat in oven as recommended in the roasting chart.
4. Fan grilling is ideally suited for cooking all types of poultry and larger joints of meat (e.g. stuffed, rolled joints and legs of pork and lamb). Results will be as if you had cooked the food on a rotisserie. If you use frozen meat or poultry it must be completely defrosted before it is cooked.
5. When cooking a joint always grill it with the fat side uppermost in order to crisp it. For bigger joints or where there is little bone, grill at the lower temperature given in the table and cook for a longer time per kg.
6. When cooking any type of poultry, start grilling the underside uppermost and turn breast uppermost about a third to halfway through the cooking period. If cooking stuffed poultry allow slightly longer cooking time.

Main Oven - Fan Grilling

Roasting Chart



DDD 5340 C KDD 3340

GB Shelf positions are counted from the base upwards ie: lowest shelf position is 1.

Type of Meat or Poultry	Weight kg	Temp °C	Time (min/kg)	Plus Extra Time (mins)	Total Cooking Time (mins)	Tips
PORK Pork Chop - thick		170	25		Dependente on size	Season. Grill on shelf position 3. Turn over after 15 mins. Grill on shelf position 3 Turn after 15 mins. Score fat with sharp knife and rub on salt. Pork should always be thoroughly cooked. So overcook rather than undercook. Grill on shelf position 1.
Gammon Steaks		160	30		Dependente on size	
Pork - any type of joint	1.0	160-170	60-70	45	105-120	
	1.5	150-170	60-70	45	130-150	
	2.0	140-150	65-75	50	180-230	
	2.5	140-150	65-75	50	220-240	
	over 2.5	140	70-75	50	-	
LAMB Lamb chop - thick		170	25		Dependent on size	Season. Grill on shelf position 3. Turn over after 15 mins. Score fat. Season with pepper and rosemary. If you prefer the lamb pink choose the shorter time Grill on shelf position 1.
Lamb - any type of joint	1.0	160-170	30-40	45	78-88	
	1.5	160-170	35-40	45	90-110	
	2.0	150-160	35-45	50	120-140	
	2.5	150-160	40-45	50	150-170	
	Over 2.5	150	45-50	50	-	
BEEF Beef - joints which have an outside layer of fat eg. Rib, Rolled, Sirloin	1.0	170-180	40-50	20	60-70	Season. If joint preferred rare grill for the shorter time. If preferred well done grill for the longer time. Grill on shelf position 1.
	1.5	170-180	40-50	20	80-90	
	2.0	160-170	40-50	20	100-110	
	2.5	160-170	45-50	30	140-150	
	over 2.5	160	45-50	40	-	
CHICKEN	1.0	180	30	30	60	Season and brush over with melted butter to give nicely browned skin. Grill on shelf position 1. Shelf 1.
	1.5	180	30	30	75	
	2.0	170	35	30	100	
	2.5	170	35	30	115	
Chicken joints	over 2.5 less than 1kg each	160-170 180	40 30	30 30	- 60	
DUCK	1.5	180	30	30	75	Dry thoroughly and lightly salt. Grill on shelf position 1.
	2.0	180	30	30	90	
	2.5	180	35	30	115-130	
GOOSE	up to 4	170-190	40	40	-	Can be stuffed. Grill on shelf position 1
	4-5	160-170	45	40	-	
TURKEY	up to 5	170	-	-	150-165	Season and brush over with melted butter to give nicely browned skin. Grill on shelf position 1.
	6-8	150	-	-	165-175	
GAME Grouse	Any	170-180	30-50	-	-	Well hung meat will require less cooking time. grill on position 1.
Partridge	Any	170-180	40-50	-	-	
Pheasant	Any	170-180	40-50	-	-	
Beefburgers	450g(lb)	170	25mins per 450g (lb)			Shelf 3. Shelf 3. Prick sausages before cooking. Shelf 3. Roll up bacon before cooking. 4 pieces of steak, sausages, chops, bacon, tomatoes & mushrooms. Cook sausages, chops, bacon for 10 mins. add steak, cook for further 20 mins.
Sausages	450g(lb)	170	25mins per 450g (lb)			
Bacon	450g(lb)	170	25mins per 450g (lb)			
Mixed Grill		170			30	

Using the Main Oven for Other Functions

FAN ONLY SETTING

DEFROSTING FROZEN MEAT & POULTRY

Joints of meat and whole birds should be defrosted slowly, preferably in a refrigerator (allowing 5-6 hours per lb.) or at room temperature (allowing 2-3 hours per lb.). Frozen meat or poultry must be completely defrosted before cooking in the oven. However, to decrease the amount of time required to defrost food items, a nonheating fan only setting may be selected for the main oven only.

OPERATION: TO ASSIST IN DEFROSTING:

Place food in the oven and close the oven door. Turn Control (C or D, depending on your model) clockwise to the FAN ONLY setting:

Control C - Model **IDD 6340**

Control D - Model **DDD 5340 C**
KDD 3340

This defrosts by circulating the air around the food, time to defrost will depend on type and size of the food.

NOTES: DO NOT defrost meat and poultry by warming the food through.

Foods ideally suited to defrosting using the fan only setting are cream/cream cakes, butter cream filled cakes, gateaux, cheese cakes, iced cakes, quiches, pastries, biscuits, bread, croissants, fruit and many delicate frozen foods.

WARNING! The oven is provided with a stop system to extract the racks and prevent them from coming out of the oven.(1)

As shown in the drawing, to extract them completely, simply lift the racks, holding them on the front part, and pull (2).

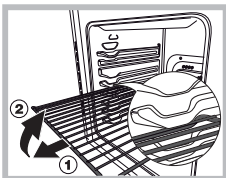

If fish, meat and poultry are to be defrosted using the fan only setting, where possible it is recommended that the food should be small and thin.

The items should be placed so that the maximum amount of surface area is exposed to the circulating air, and that they are turned regularly to ensure even defrosting.

Larger cuts of meat and poultry may be defrosted by using the fan only setting up to a maximum weight of 2 kg (4lb 8oz).

It is important to wash both meat and poultry and cooking utensils immediately after defrosting and before cooking. Food should be cooked immediately after defrosting.

It is very important to strictly adhere to the basic principles of food handling and hygiene to prevent the possibility of bacterial growth.

LIGHT ONLY SETTING

When Control (C or D, depending on your model) is turned clockwise to the LIGHT ONLY setting, the main oven light only will illuminate:

Control C - Model **IDD 6340**

Control D - Model **DDD 5340 C**
KDD 3340

Main Oven - Convention Oven

DDD 5340 C KDD 3340



GB

Important

NEVER line the shelves, the floor or the sides of the oven with aluminium foil as overheating and damage may result.

The oven is heated by elements at the top of the oven and underneath the floor of the oven.

Food should not be placed on the floor of the oven

Operating Procedure

1. Ensure Oven Timer is set to Manual.
2. Position rod shelf as recommended in the chart for food being cooked.
3. Position food centrally under grill element.
4. Turn the selector switch to the conventional oven position.
5. Turn the oven thermostat control to the required temperature setting (see oven temperature charts). The oven light will remain on. The oven indicator light will remain on until the oven reaches the set temperature. This light will then automatically cycle on and off during cooking as the oven temperature is controlled.
6. After use always return both controls to the off position and close the oven door.

Main Oven - Fan Oven (all Models)

GB

Important

NEVER line the shelves, the floor or the sides of the oven with aluminium foil as overheating and damage may result.

The oven is heated by elements at the rear of the oven.

A fan at the rear of the oven operates to circulate heated air within the oven.

Operating Procedure

1. Ensure Oven Timer is set to Manual.
2. Turn the selector switch to the fan oven position.
3. Turn the oven thermostat control to the required temperature setting (see Main Oven temperature charts).
The oven light will remain on.
The oven indicator light will remain on until the oven reaches the set temperature. This light will then automatically cycle on and off during cooking as the oven temperature is controlled.
4. After use always return both controls to the off position and close the oven door.

DDD 5340 C

KDD 3340

IDD 6340

Oven shelf supports

The shelf supports are removable and dishwasher safe.

To remove hold the support at the front and pull away from the oven side, this can then be cleaned in a sink or a dishwasher.

When removed it allows access to the oven side, which can be cleaned with warm soapy water.

To refit the support, insert the longer leg into the rear fixing hole and push in the front leg.

Main Oven - Fan Oven

Cookery Notes

GB

Since a fan oven heats up more quickly, and generally cooks food at a lower temperature than a conventional oven, pre-heating the oven is often unnecessary. However, foods such as bread, scones, Yorkshire pudding, do benefit from being placed in a pre-heated oven.

The charts are a guide only, giving approximate cooking temperatures and times. To suit personal taste and requirements, it may be necessary to increase or decrease temperatures by 10°C.

Because the fan oven cooks so efficiently, we recommend that when cooking any recipes not designed for a fan oven, you reduce the temperature by about 25°C and the time by about 10 minutes in the hour. If large quantities are being cooked it will be necessary to increase the cooking time somewhat to compensate for the extra oven load.

Unless otherwise indicated in the charts, food is placed in a cold oven, i.e. without preheating. If food is placed in an already hot oven, the suggested cooking time should be reduced, depending on the type and quantity of food being cooked.

It should be noted that at the end of a cooking period there may be a momentary puff of steam when the oven door is opened, this will disperse in a few seconds and is a perfectly normal characteristic of an oven with a good door seal.

Oven Positions

Since the distribution of heat in the fan oven is very even, most foods will cook satisfactorily on any shelf position, but the shelves should be evenly spaced:

To ensure even circulation do not use meat pans larger than 390x300mm (15ins x 12ins) and baking trays no larger than 330 x 255mm (13ins x 10ins), these should be positioned centrally on the oven shelf.

- Do not fit shelves upside down.
- Never use more than 3 shelves in the oven as air circulation will be restricted.
- Food or cooking utensils should not be placed on the floor of the oven. To avoid unnecessary cleaning, rod shelves which are not in use should be removed from the oven.

Main Oven - Fan Oven

Cookery Notes

GB

Temperature and Time

The oven is provided with two shelves. A third is available as an optional extra, contact Genuine Parts and Accessories Hotline (see back page) for further information.

If three shelves are used to cook large quantities of food for home freezing or parties, it may be necessary to increase the cooking times given in the charts by a few minutes, to allow for the loss of heat due to the extra time taken to load the oven, and the larger mass of food.

Baking trays should allow an equal gap on all sides of the oven.

To prepare meat and poultry for Roasting in your Fan Oven

- (a) Wipe the meat or poultry, dry well and weigh it. Meat which has for been stored in a refrigerator should be allowed to come to room temperature before cooking, and frozen meat or poultry must be completely defrosted before placing in the oven.
- (b) The weight of any stuffing used should be added before calculating the cooking time.
- (c) Small joints weighing less than 1.75kg (3 1/2 lbs) should be roasted in a smaller meat pan/tin - or they may be 'pot roasted' - a small joint or a large meat pan causes unnecessary oven splashing and evaporation of meat juices.
- (d) Additional fat should not be added, except for veal, very lean meat or poultry which can either be 'larded' with fat bacon or brushed very sparingly with cooking oil or melted fat.
- (e) Beef, lamb, mutton and poultry may be dusted lightly with seasoned flour to give a crisp outer surface. The skin of duck and goose should be pricked to release excess fat during cooking, and the rind of pork should be scored, brushed lightly with oil, and rubbed with salt to give crisp crackling.
- (f) Meat and poultry wrapped in, or covered with a tent of aluminium foil will be juicy and tender. Roasting bags offer the same advantages. Always follow the manufacturer's pack instructions, and remember to reduce the temperatures given for conventional ovens by approximately 25°C and the time by approximately 10 minutes per hour.
- (g) Potatoes for roasting only require to be brushed with cooking oil or melted fat.
- (h) It is not necessary to baste when roasting in an electric oven and stock or liquid should not be added to the meat pan since this only causes unnecessary soiling, steam and condensation.

Frozen Meat and Poultry

Joints of meat and whole birds should be defrosted slowly, preferably in a domestic refrigerator (allowing 5-6 hours per 450g, 1 lb), or at room temperature (allowing 2-3 hours per 450g, 1 lb).

Frozen meat or poultry must be completely defrosted before placing in the oven.

It is essential to wash thoroughly and cook meat and poultry immediately after defrosting.

Main Oven Temperature Chart

GB

Conventional Oven DDD 5340 C KDD 3340				
It is not necessary to pre-heat the fan oven before roasting. Note: Where times are stated, they are approximate only.				
Meat	Pre-heat	Temperature °C	Time (approx.)	Position in Oven
Beef/ Lamb (slow roasting)	Yes	170/180	35 mins per 450g (1lb) + 35 mins over.	Runner 2 or 3 from bottom of oven.
Beef/ Lamb (foil covered)	Yes	190/200	35-45 mins per 450g (1lb)	
Pork (slow roasting)	Yes	170/180	40 mins per 450g (1lb) + 40 mins over	
Pork (foil covered)	Yes	190/200	40 mins per 450g (1lb)	
Veal (slow roasting)	Yes	170/180	40-45 mins per 450g (1lb) + 40 mins over	
Veal (foil covered)	Yes	190/200	40-45 mins per 450g (1lb)	
Poultry/Game (slow roasting)	Yes	170/180	25-30 mins per 450g (1lb) + 25 mins over	
Poultry/Game (foil covered)	Yes	190/200	25-30 mins per 450g (1lb)	
Casserole Cooking	Yes	150	2-2½ hrs	
If using aluminium foil, never: 1.Allow foil to touch sides of oven. 2.Cover oven interior with foil. 3.Cover shelves with foil.				

Fan Oven DDD 5340 C KDD 3340				
It is not necessary to pre-heat the fan oven before roasting. Note: Where times are stated, they are approximate only.				
Meat	Pre-heat	Temperature °C	Time (approx.)	Position in Oven
Beef	No	160/180	20-25 mins per 450g (1lb) + 20 mins extra.	Runner 2 or 3 from bottom of oven.
Lamb	No	160/180	20-30 mins per 450g (1lb) +25 mins extra.	
Pork	No	160/180	25-30 mins per 450g (1lb) +25 mins extra.	
Veal	No	160/170	25-30 mins per 450g (1lb) +25 mins extra.	
Chicken/Turkey up to 4kg (8lb)	No	160/180	18-20 mins per 450g (1lb) + 20 mins extra.	
Turkey 4 to 5.5kg (8 to 12lb)	No	150/160 or 150	25-30 mins per 450g (1lb)	
Casserole Cooking	No	140-150	1½ - 2 hrs	
If using aluminium foil, never: 1.Allow foil to touch sides of oven. 2.Cover oven interior with foil. 3.Cover shelves with foil.				

The most accurate method of testing the readiness of joints of meat or whole poultry is to insert a meat thermometer into the thickest part of a joint, or the thickest part of poultry thighs, during the cooking period. The meat thermometer will indicate when the required internal temp has been reached.

Beef -	Rare: 60°C	Lamb: 80°C	Poultry: 90°C
	Medium: 70°C	Pork: 90°C	
	Well Done: 75°C	Veal: 75°C	

Main Oven Temperature Chart

Baking	Conventional Oven DDD 5340 C KDD 3340			
Food	Pre-heat	Temperature °C	Time in mins.	Shelf Position
Scones	Yes	220/230	10-15	2nd from bottom
Small Cakes	Yes	180/190	15-25	3rd from bottom
Victoria Sandwich	Yes	160/170	20-30	3rd from bottom
Sponge Sandwich (fatless)	Yes	170/180	15-20	3rd from bottom
Swiss Roll	Yes	190/200	8-12	3rd from bottom
Semi-rich Fruit cakes	Yes	150/160	1¼ hrs. 7"	2nd from bottom
Rich Fruit Cakes	Yes	130/140	Depending on recipe and size	2nd from bottom
Shortcrust Pastry	Yes	180/190	Depending on use	2nd or 3rd from bottom
Puff Pastry	Yes	190/200	Depending on use	2nd or 3rd from bottom
Yorkshire Pudding	Yes	190/200	40-45	3rd from bottom
Individual Yorkshire Pudding	Yes	200/210	20-30	3rd from bottom
Milk Pudding	Yes	140/150	1¼ - 2 hrs.	2nd from bottom
Baked Custard	Yes	130/140	40-50	3rd from bottom
Bread	Yes	190/200	25-35	3rd from bottom
Meringues	Yes	80/90	3 - 3½ hrs.	3rd from bottom

Baking	Fan Oven DDD 5340 C KDD 3340			
Food	Pre-heat	Temperature °C	Time in mins.	Shelf Position
Scones	Yes	210/220	9-12 approx.	2nd from bottom
Small Cakes	No	170/180	15-25 approx.	3rd from bottom
Victoria Sandwich	No	160/170	20-30 approx.	3rd from bottom
Sponge Sandwich (fatless)	Yes	180/190	15-20 approx.	3rd from bottom
Swiss Roll	Yes	190/200	12-15 approx.	3rd from bottom
Semi-rich Fruit cakes	No	140/150	1¼ - ½ hrs. approx.	2nd from bottom
Rich Fruit Cakes	No	130/140	Depending on size	2nd from bottom
Shortcrust Pastry	No	190/200	Depending on size	2nd or 3rd from bottom
Puff Pastry	No	190/200	Depending on size	2nd or 3rd from bottom
Yorkshire Pudding	Yes	180/190	40-50 approx.	3rd from bottom
Individual Yorkshire Pudding	Yes	190/200	20-25 approx.	3rd from bottom
Milk Pudding	No	130/140	1½ - 2 hrs. approx.	2nd from bottom
Baked Custard	No	140/150	35-45 approx.	3rd from bottom
Bread	Yes	200/210	30-35 approx.	3rd from bottom
Meringues	No	80/90	3 - 4 hrs. approx.	3rd from bottom

Note: If soft tub margarine is used for cake making, we would recommend using the all in one method and to reduce the temperature by 10°C.

Temperatures recommended in this chart refer to cakes made with block margarine or butter only.

Note: Where times are stated, they are approximate only.

Main Oven Grilling

DDD 5340 C KDD 3340

GB

DO NOT allow young children near the appliance when the grill is in use as the surfaces can get extremely hot.

GRILLING SHOULD NEVER BE UNDERTAKEN WITH THE DOOR CLOSED.

- Do Not line the grill pan with aluminium foil.
- Ensure that the grill pan is cleaned after every use. Excess fat build-up in the bottom of the pan could cause a fire hazard.
- Preheat the grill on the required setting for 5 minutes

Grilling Procedure:

1. Open the main oven door fully and position the rod shelf as recommended in the grilling chart (see below) for the food being cooked.
2. Turn the multifunction selector switch to HALF grill or FULL grill and then turn the Main Oven temperature control to the required setting to pre-heat for approximately 5 minutes.
3. Position the grill pan centrally under the grill element and push back as far as the location stops on the rod shelf.
4. Leave the oven thermostat at setting MAX for toast and for fast cooking of foods. For thicker foods requiring longer cooking turn the thermostat to a lower setting, after initial sealing on both sides at MAX. The thicker the food, the lower the thermostat should be set. If excessive smoke is emitted, reduce the setting.
5. After use always return both controls to their OFF (O) position.

Food	Shelf Position from base of oven	Setting Required Temp °C	Cooking Time
Toasting of bread products	6	230	2-5 mins
Small cuts of meat, sausages, bacon etc.	5 or 6	230 for 4 - 6 mins then reduce to setting 170	10-20 mins
Chops, gammon steaks etc.	5	230 for 6 - 8 mins then reduce to setting 170	20-30 mins
Fish: Whole / Fillets	5	170	15-20 mins
Fingers	6	230	10-15 mins
Pizza's	5	170	10-15 mins
Browning of food	5	230	5-10 mins

Care and Cleaning

Warning: Before cleaning, please ensure that the electricity supply to the appliance is switched off and the appliance is fully cold.

! Never use steam cleaners or pressure cleaners on the appliance.

! Clean the glass part of the oven door using a sponge and a non-abrasive cleaning product, then dry thoroughly with a soft cloth. Do not use rough abrasive material or sharp metal scrapers as these could scratch the surface and cause the glass to crack.

! The accessories can be washed like everyday crockery (even in your dishwasher).

1. CATALYTIC OVEN LINERS* (Top Oven Sides, Main Oven Sides and Rear Panel)

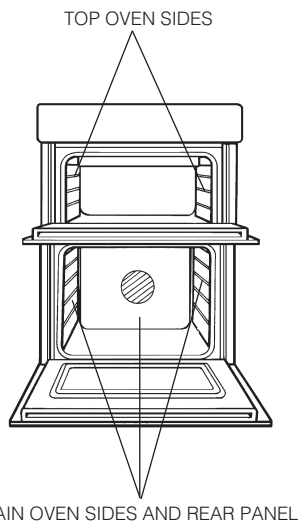

(a) How catalytic oven liner works.

The surfaces of the oven liners are treated with a special vitreous enamel which absorbs cooking soils.

At temperatures of 220°C (425°F) or above, the special surface enables these soils to be slowly destroyed. The higher the temperature the more effective it is.

(b) Cleaning.

In most cases normal cooking operations at 220°C (425°F) will permit this cleaning operation to proceed during cooking. However if higher cooking temperatures are not used regularly, it may be necessary, in order to prevent heavy soiling, to run the ovens without shelves, at a maximum setting for a couple of hours.

It should not normally be necessary to clean the panels with water. If the user feels it is desirable to do so, wipe them over with a clean, soapy cloth, followed by a wipe with a clean damp cloth.

DO NOT use biological washing powder, harsh abrasives or chemical oven cleaners of any kind as this could damage the "Stayclean" oven liners.

2. CLEANING GRILL, TOP OVEN AND MAIN OVEN*

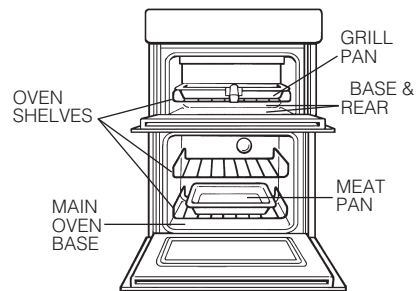

(a) Base & Rear of Top Oven and Base of Main Oven.

Wipe out the oven with a damp soapy cloth. For more stubborn stains on the base of the oven use a well soaped fine steel wool soap pad.

(b) Grill Pan & Oven Shelves.

To prevent stains from being burnt on to the grill pan, food support and rod shelf, always wash immediately after use in warm soapy water. Use a well soaped fine steel wool soap pad to remove stubborn stains from the rod shelves and grill pan and the base of the oven.

DO NOT use aerosol cleaners on this oven as they could adversely affect the fan motor unit, and cannot be wiped off the fan blade.

* Only on certain models

3. OVEN DOORS

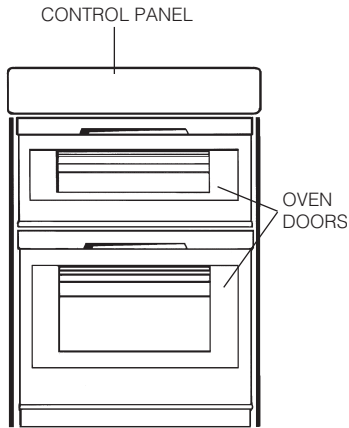

(a) Control Panel

Regularly wipe with a clean, damp cloth and polish with a clean, dry cloth.

(b) Inner Door Panels & Glass

Open the door fully. The glass panel may now be washed. Stubborn stains can be removed by using a well soaped, fine steel wool soap pad.

(c) Stainless trims (SS models only)

Regularly wipe with a clean, damp cloth and polish with a clean dry cloth.

DO NOT use scouring pads, or abrasive powder, which will scratch the glass.

4. REPLACEMENT OF THE OVEN LAMP

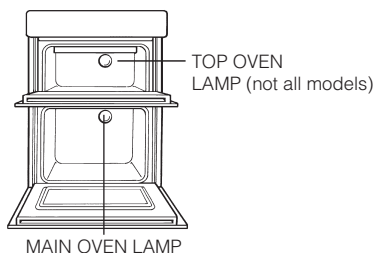

Warning: To avoid electric shocks - please ensure that the electricity supply to the appliance is switched off and the appliance is fully cold, before removing the lamp lens.

Open the oven door and remove the oven shelves. Using a thick cloth, grip the lamp lens, unscrew anticlockwise and remove the lens. Carefully unscrew the bulb anti-clockwise. Fit replacement bulb (25W 300°C SES) and refit lens.

5. HOW TO CLEAN THE LAMP LENS

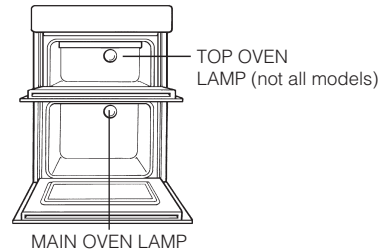

Warning: To avoid electric shocks - please ensure that the electricity supply to the appliance is switched off and the appliance is fully cold, before cleaning lamp lens.

Open the oven door and remove the oven shelves. Using a thick cloth, grip the lamp lens, unscrew anticlockwise and remove. Clean with a non-abrasive cleansing cream and refit lamp lens.

DO NOT use scouring pads, or abrasive powder, which will scratch the glass lens

! Do not use the oven lamp as/for ambient lighting

Care and Cleaning

Take particular care not to damage the inner surface of the door inner glass that is coated with a heat reflective layer. Do not use scouring pads, or abrasive powder, which will scratch the glass. Ensure that the glass panel is not subjected to any sharp mechanical blows.

Stubborn stains can be removed by using a fine steel wool pad. For slight soiling the inner glass panel may be cleaned, while still warm, without removing it from the door. After cleaning, rinse and dry with a soft cloth.

CLEANING THE DOORS

SIDE OPENING DOORS

Cleaning the door glass is the same as the drop down doors, except take care to support the weight of the inner glass when removing and refitting.

DROP DOWN DOORS

Remove the door inner glass as follows.

1. Open the door fully and unscrew the two screws securing the glass panel so that the securing brackets can be turned. There is no need to remove the screws completely.

2. Turn the brackets so that the glass can be removed and cleaned at the sink (Fig. 1.).

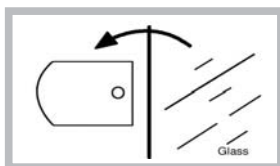

3. The inside of the outer door glass can now be cleaned while still fitted to the cooker.

NEVER OPERATE THE COOKER WITHOUT THE INNER DOOR GLASS IN POSITION.

Refit the door inner glass as follows.

1. **NOTE:** The inner door glass has a special reflective coating on one side. Replace the door inner glass so that the statement: "**IMPORTANT THIS FACE TOWARDS THE OVEN**" can be read from the inner side of the door.

2. Turn the two securing brackets back to their original position to retain the glass and tighten the screws (Fig. 2.)

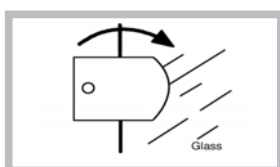

Respecting and conserving the environment

- Whenever possible, avoid pre-heating the oven and always try to fill it. Open the oven door as little as possible because heat is lost every time it is opened. To save a substantial amount of energy, simply switch off the oven 5 to 10 minutes before the end of your planned cooking time and use the heat the oven continues to generate.
- Keep gaskets clean and tidy to prevent any door energy losses
- If you have a timed tariff electricity contract, the "delay cooking" option will make it easier to save money by moving operation to cheaper time periods.

If Something Goes Wrong?

GB

**Before calling a Service Engineer, please check through the following lists.
THERE MAY BE NOTHING WRONG.**

Problem	Check
Slight odour or small amount of smoke when grill / oven used for first time	This is normal and should cease after a short period.
Nothing works	If you find that the timer display is blank, then it is likely that there is no electricity supply to your oven. Check: (i) That the main cooker wall is switched on (ii) Other appliances, to see if you have had a power cut (iii) The main circuit breaker for the property
Timer Display shows '0.00' with "Auto" Flashing	The power supply to your oven has possibly been interrupted, but has now come back on again. Reset the timer to the correct day and "Manual" operation using the instructions given in the timer section of the book.
Main oven and Top ovens do not work, but the grill works	Your timer may be set for an Auto Cooking programme: Check the timer to see whether 'Auto' is lit or flashing. If it is then please follow the instructions given in the Timer section of this book to return the timer to Manual operation.
Top oven and grill do not work, but Main oven works.	Operating the cooker under the following conditions may cause a safety device to operate: (a) Grilling with the door closed - Always grill with the door fully open (b) Grilling for an excessively long period at maximum setting - see Grilling guide. Switch off appliance and allow to cool for approx 30 mins. Switch the cooker back on and check that the Grill / Top oven is now operating.
Grill keeps turning on and off	When the Grill control is operating at less than its maximum setting, the Grill will cycle on and off, this is normal and <u>not</u> a fault.
Draught from beneath control panel	A gentle flow of air will be blown from beneath the control panel when the appliance is used. If the appliance is still warm, this cooling fan may run on, or restart itself after all of the controls have been turned off. The fan will stop once the appliance has been cooled. This is normal and <u>not</u> a fault.
Timer buzzer / audible tone operates continually	To cancel the audible tone, press the minute minder button.
Grilling is uneven	Ensure that Grill pan has been positioned as stated in the Grilling section of this book.
Oven does not cook evenly	Check: (a) Temperature and shelf positions are as recommended in the Oven Temperature Charts. (b) Oven utensils being used allow sufficient air flow around them.
Oven temperatures too high or low	Check temperature and shelf positions are as recommended in the Oven Temperature Charts. It may be necessary to increase or decrease the recommended temperature slightly to suit your taste.
Oven lamp does not work	The oven lamp is not covered by the guarantee. The part is easily changed (see section on oven lamp replacement). A new lamp may be obtained from our Parts department (see back page).
Condensation on the wall at the rear of the cooker.	Steam and / or condensation may appear from the vent at the rear of the appliance when using an oven particularly for foods with a high water content e.g. frozen chips, roast chicken etc. This is normal, and any excess should be wiped off.
Steam / Condensation in the oven after use.	Steam is a by - product of cooking any food with a high water content. To help minimise always: a) Try to avoid leaving food in the oven to cool after being cooked b) Use a covered container, wherever possible.

If it Still Won't Work

GB

Contact the Service Office

If something is still wrong with your appliance after you have been through the 'Something Wrong' list:

1. Switch off and unplug the appliance from the mains.
2. Call your nearest Service Office or local importer.

When you contact us we will want to know the following:

1. Your name, address and postcode.
2. Your telephone number.
3. Clear and concise details of the fault.
4. The Model number and the Serial number of your appliance.
5. The date of purchase (please keep the receipt as evidence will be required when an engineer calls) enter the date here:

.....
Please make sure you have all these details ready when you call.

Spare Parts

Please remember your new appliance is a complex piece of equipment. 'DIY' repairs or unqualified and untrained service people may put you in danger, could damage the appliance and might mean you lose cover under the Parts Guarantee. If you do experience a problem with the appliance don't take risks, call in our Service Engineer. Our Parts are designed exclusively to fit your appliance. Do not use them for any other purpose as you may create a safety hazard.

Disposal of your product

To minimise the risk of injury to children please dispose of your product carefully and safely. Remove all doors and lids. Remove the mains cable (where fitted) by cutting off flush with the appliance and always ensure that no plug is left in a condition where it could be connected to the electricity supply. To help the environment, Local Authority instructions should be followed for the disposal of your product.



Product Guarantee and Repair Information

Guarantee

12 Months Parts and Labour Guarantee

Your appliance has benefit of our manufacturer’s guarantee, which covers the cost of breakdown repairs for twelve months from the date of purchase. This gives you the reassurance that if, within that time, your appliance is proven to be defective because of either workmanship or materials, we will, at our discretion, either repair or replace the appliance at no cost to you:

This guarantee is subject to the following conditions:

- The appliance has been installed and operated correctly and in accordance with our operating and maintenance instructions.
- The appliance is used only on the electricity or gas supply printed on the rating plate.
- The appliance has been used for normal domestic purposes only.
- The appliance has not been altered, serviced, maintained, dismantled, or otherwise interfered with by any person not authorised by us.
- Any repair work must be undertaken by us or our appointed agent.
- Any parts removed during repair work or any appliance that is replaced become our property.
- The appliance is used in the United Kingdom or Republic of Ireland.

The guarantee does not cover:

- Damage resulting from transportation, improper use, neglect or interference or as a result of improper installation.
- Replacement of any consumable item or accessory. These include but are not limited to:plugs,cables,batteries,light bulbs,fluorescent tubes and starters, covers and filters.
- Replacement of any removable parts made of glass or plastic.

THIS GUARANTEE WILL NOT APPLY IF THE APPLIANCE HAS BEEN USED IN COMMERCIAL OR NON-DOMESTIC PREMISES.

Recycling and Disposal Information

As part of Hotpoint’s continued commitment to helping the environment, Hotpoint reserves the right to use quality, recycled components to keep down customer costs and minimise material wastage.

Please dispose of packaging and old appliances carefully. To minimise the risk of injury to children, remove the door, plug, and cut the mains cable off flush with the appliance. Dispose of these parts separately to ensure that the appliance can no longer be plugged into mains socket, and the door cannot be locked shut.

Repairs and After Sales

For product help and advice, repairs, spare parts or accessories, we're here to help.

For local repair engineers - **03448 111 606**
ROI - **0818 313 413**

UK standard local rate applies
ROI local Irish rate applies

For Parts and Accessories visit:
parts.hotpoint.co.uk/shop

Please remember to register your appliance at **www.hotpointservice.co.uk** to activate your 10 year parts guarantee.

Please note, our advisors will require the following information:

Model number:

Serial number:

