



设计人员: 张妹珍 QQ: 99739279

制作日期: 2018-1-26

运用软件: Adobe Acrobat 7 Pro

TEL:0573-83225888-503 Http:www.yattool.com

名称: 说明书
客户: CH171
料号: **8458-4353017-011**
成品尺寸: **A5(148.5x210mm)**
材质: 80g双胶纸

颜色: 一个专色 (PT282U)
页数: 8张A4纸

备注:



**SPEAR &
JACKSON**

INSTRUCTION MANUAL

2000W 40cm

Electric Chainsaw S2040EC

YT4353-01



**Important - Please read these instructions
fully before starting assembly**

The instruction contain important information that will help you get the best from your chain saw, ensuring it is assembled correctly and safely. If you need help or have damaged or missing parts, call the customer helpline on 0345 605 2070

**AFTER SALES SUPPORT
0345 605 2070**

SPEAR & JACKSON SINCE 1760

For more than 250 years gardeners have enjoyed high quality performance and great results using Spear & Jackson tools. Our garden power tools combine continuous innovation and the latest in manufacturing technologies with a proud heritage. Each product is carefully designed with performance, comfort and durability firmly in mind, which has earned Spear & Jackson an enviable reputation as a maker of tools to trust.

3 YEARS GUARANTEE

As a testament to the quality of our products, we offer a 3 year manufacturers warranty and a comprehensive after sales service. The warranty covers manufacturing faults, however in the event that the item has been deliberately damaged, used in a commercial environment or disassembled then the warranty will be null and void. Please retain proof of purchase.

TECHNICAL SUPPORT

We want you to get the best out of your products. Our easy-to-read instruction manual guides you with best practice use and maintenance tips. Please call 0345 605 2070 for technical support, we can solve around 80% of questions directly over the phone.

We hope you enjoy your product and we look forward to any feedback, as this allows us to develop even better products for the future.

CONTENTS

SAFETY INFORMATION	4
Description of symbols.....	4
General Power Tool Safety Warning.....	5
Work Safety.....	5
Electrical Safety.....	5
Personal Safety.....	6
Power Tool Use and Care.....	8
Intended use.....	9
Residual risks.....	9
IN THE BOX	11
Parts list.....	11
ASSEMBLE & PREPARE	12
PREPARE	12
Oil filling.....	12
Remove the bar sheath.....	12
Check the chain tension.....	12
Settle the power cord.....	13
Connect to the power source.....	13
Locate the chain brake	13
Check the oil passes.....	14
OPERATE	14
Hold the machine.....	15
Switch On/Off.....	16
Start cutting	16
Disconnect the power source.....	18
Limbing.....	20
Bucking.....	20
Bucking using a sawhorse.....	21
Maintenance	23
Adjust the chain tension.....	23
Cleaning saw body	24
Care of the chain.....	24
Care of guide bar.....	25
Flip the bar.....	25
Storing.....	26
TECHNICAL DATA	27
Environmental protection	27
TROUBLESHOOTING	28
WARRANTY	29

SAFETY INFORMATION

Please read these instructions fully before operating or maintaining your machine

DESCRIPTION OF SYMBOLS

The following warning symbols appear throughout this manual and indicate the appropriate safety measures you should take when operating and maintaining the electric chain saw.



Indicates danger, warning, or caution.



WARNING – To reduce the risk of injury, user must read instruction manual.



Wear ear protection, eye protection, respirator and gloves when using the product.



Wear safety boots to protect against electric shock



Do not expose to rain



Remove plug from the mains immediately if cable is damaged or cut



Make sure the “chain brake” is disengaged.



Conforms to relevant safety standards.



This class II symbol indicates that the product is correctly insulated. Grounding this machine is therefore unnecessary.



Environmentally friendly way. Please recycle where facilities exist. Check with your local council authority for recycling advice.



Guaranteed sound power level (tested according to Directive 2000/14/EC as amended by 2005/88/EC)

SAFETY INFORMATION

Please read these instructions fully before operating or maintaining your machine

GENERAL POWER TOOLS SAFETY WARNINGS



WARNING Read all safety warnings and all instructions.

Failure to follow the warnings and instructions may result in electric shock, fire and/or serious injury.



WARNING! Read all safety warnings designated by the symbol and all instructions. Save all warnings and instructions for future reference.

The term "power tool" in the warnings refers to your mains-operated (corded) power tool or battery-operated (cordless) power tool.

Work Area Safety

- a) Keep work area clean and well lit. Cluttered or dark areas invite accidents.

- b) Do not operate power tools in explosive atmospheres, such as in the presence of flammable liquids, gases or dust.

Power tools create sparks which may ignite the dust or fumes.

- c) Keep children and bystanders away while operating a power tool. Distractions can cause you to lose control.

Electrical Safety

- a) Power tool plugs must match the outlet. Never modify the plug in any way. Do not use any adapter plugs with earthed (grounded) power tools. Unmodified plugs and matching outlets will reduce risk of electric shock.

SAFETY INFORMATION

Please read these instructions fully before operating or maintaining your machine

- b) Avoid body contact with earthed or grounded surfaces, such as pipes, radiators, ranges and refrigerators.
There is an increased risk of electric shock if your body is earthed or grounded.
- c) Do not expose power tools to rain or wet conditions. Water entering a power tool will increase the risk of electric shock.
- d) Do not abuse the cord. Never use the cord for carrying, pulling or unplugging the power tool. Keep cord away from heat, oil, sharp edges or moving parts. Damaged or entangled cords increase the risk of electric shock.
- e) When operating a power tool outdoors, use an

extension cord suitable for outdoor use.
Use of a cord suitable for outdoor use reduces the risk of electric shock.

- f) The use of a residual current device (RCD) when using this tool is recommended. Use of an RCD reduces the risk of electric shock.

Personal Safety

- a) Stay alert, watch what you are doing and use common sense when operating a power tool. Do not use a power tool while you are tired or under the influence of drugs, alcohol or medication.
A moment of inattention while operating power tools may result in serious personal injury.
- b) Use personal protective

SAFETY INFORMATION

Please read these instructions fully before operating or maintaining your machine

equipment. Always wear eye protection.

Protective equipment such as dust mask, non-skid safety shoes, hard hat, or hearing protection used for appropriate conditions will reduce personal injuries.

- c) Prevent unintentional starting. Ensure the switch is in the off-position before connecting to power source and/or battery pack, picking up or carrying the tool. Carrying power tools with your finger on the switch or energising power tools that have the switch on invites accidents.
- d) Remove any adjusting key or wrench before turning the power tool on.
A wrench or a key left

attached to a rotating part of the power tool may result in personal injury.

- e) Do not overreach. Keep proper footing and balance at all times. This enables better control of the power tool in unexpected situations.
- f) Dress properly. Do not wear loose clothing or jewellery. Keep your hair, clothing and gloves away from moving parts. Loose clothes, jewellery or long hair can be caught in moving parts.
- g) If devices are provided for the connection of dust extraction and collection facilities, ensure these are connected and properly used. Use of dust collection can reduce dust-related hazards.

SAFETY INFORMATION

Please read these instructions fully before operating or maintaining your machine

Power Tool Use and Care

- a) Do not force the power tool. Use the correct power tool for your application.

The correct power tool will do the job better and safer at the rate for which it was designed.

- b) Do not use the power tool if the switch does not turn it on and off. Any power tool that cannot be controlled with the switch is dangerous and must be repaired.

- c) Disconnect the plug from the power source and/ or the battery pack from the power tool before making any adjustments, changing accessories, or storing power tools. Such preventive safety measures reduce the risk of starting the power tool accidentally.

- d) Store idle power tools out of the reach of children and do not allow persons unfamiliar with the power tool or these instructions to operate the power tool. Power tools are dangerous in the hands of untrained users.

- e) Maintain power tools. Check for misalignment or binding of moving parts, breakage of parts and any other condition that may affect the power tool's operation. If damaged, have the power tool repaired before use.

Many accidents are caused by poorly maintained power tools.

- f) Keep cutting tools sharp and clean. Properly maintained cutting tools with sharp

SAFETY INFORMATION

Please read these instructions fully before operating or maintaining your machine

cutting edges are less likely to bind and are easier to control.

- g) Use the power tool, accessories and tool bits etc. in accordance with these instructions, taking into account the working conditions and the work to be performed.

Use of the power tool for operations different from those intended could result in a hazardous situation.

Intended use

The chain saw is intended for sawing of trees, tree trunks, branches, wooden beams, planks, etc. Cuts can be sawed with or across the grain. This product is not suitable for sawing mineral materials. Furthermore a professional use for tree services is

strictly forbidden.

The user and not the manufacturer is liable for every accident which results from a combination of not intended use or a not allowed change of the construction on the machine.

The chain saw is only intended to use outdoor.

Residual risks

Even with the intended use of the appliance there is always a residual risk, which can not prevented. According to the type and construction of the appliance the following potential hazards might apply:

- Contact with exposed saw teeth of the saw chain (cutting hazards)

SAFETY INFORMATION

Please read these instructions fully before operating or maintaining your machine

- Access to the rotating saw chain (cutting hazards)
- Unforeseen, abrupt movement of the guide bar (cutting hazards)
- Flung out of parts from the saw chain (Cutting / injection hazards)
- Flung out of parts of the work piece
- Inhalation of work piece particles,
- Skin contact with the oil,
- Loss of hearing, if no required ear protection used during work.

IN THE BOX

Parts List

1. REAR HANDLE
2. SWITCH ON/OFF
3. LOCK-OFF BUTTON
4. OIL TANK CAP
5. FRONT HANDLE
6. BRAKE (HAND GUARD)
7. GUIDE BAR
8. CHAIN
9. BAR COVER

10. BAR LOCKING KNOB
11. CHAIN TENSIONING KNOB
12. SPIKED BUMPER
13. CHAIN SHEATH
14. POWER CORD/CABLE
15. OIL BOTTLE.
16. CABLE CLIP

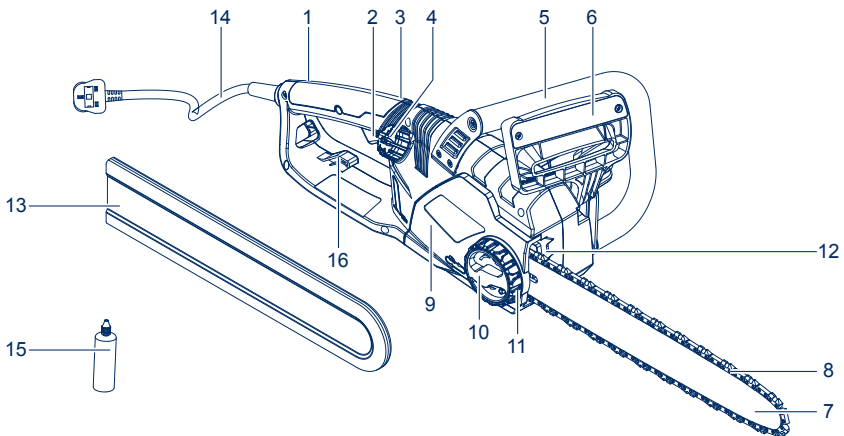

ASSEMBLE

The chain saw has been assembled in the standard delivery so no need for extra assembling steps.

PREPARE

1 Oil filling

Open the oil bottle (press the cap on the oil bottle and turn counterclockwise to open it), then open oil tank cap to fill in the oil.

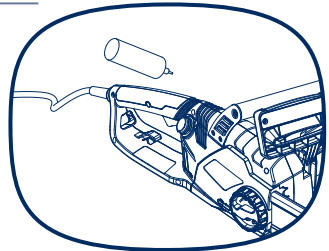

2 Remove the bar sheath

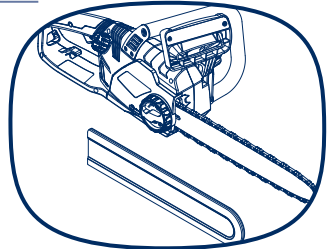

3 Check the chain tension

Always check the chain tension before use, after the first cuts and regularly during use, approx. every 10 minutes.

The lowest cutters should be underneath the bar solidly and contact the bar, if not, adjust the chain with protection gloves (Please refer to the detailed info in later chapter "Adjust the chain tension").

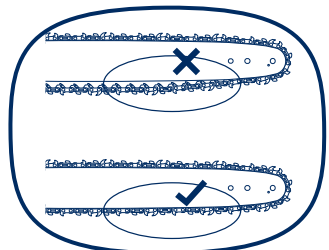

PREPARE

4 Settle the power cord.

The power cord should be wrapped around the cable clip to avoid long lines stumbling pedestrians or causing electric shock.

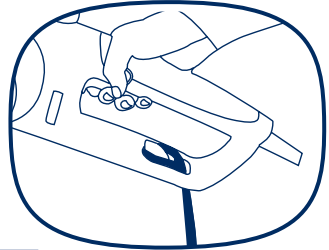

5 Connect to the power source

Insert the power cord/plug to the power source before starting to work.

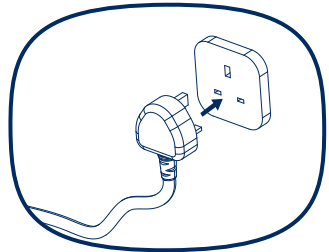

6 Locate the chain brake

The motor will not start if the chain brake is in the engaged position.

Disengage the chain brake level by pulling backward toward the front handle. Keep brake setting is in correct position before use, and ensure chain saw operate normally.

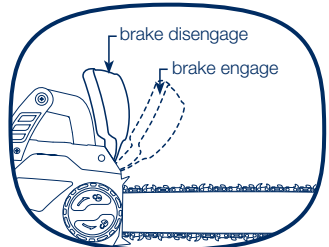

PREPARE

Make sure the chain brake is working before using the chain saw. To check brake operation:

- Place the saw on a firm, flat surface.
- Start the saw briefly. Please refer to later chapter "switch on/off" for how to start the machine
- Keep the left hand on the front handle and roll the left wrist to move the front hand guard forward to manually activate the chain brake. If the chain brake works normally the machine will stop after brake engage. Otherwise there is malfunction to the machine and seek help from service center before using.

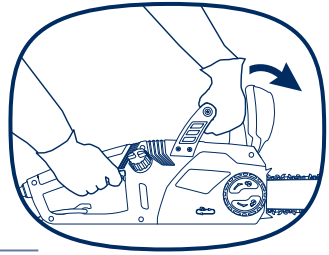

7 Check the oil passes

Start the machine and check whether the chain can give off a spray of oil within a few seconds. If an oil trace can be seen, the chainsaw is lubricating.

NOTE! Never saw when a sufficient chain lubrication is not guaranteed. Before starting work check the oil level in the tank and the oil feeding.

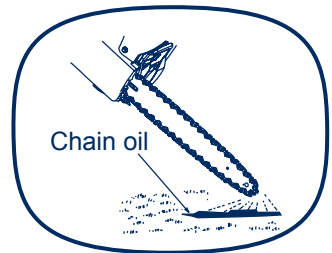

PREPARE

Caution! Never starve the bar and chain of lubrication oil. Running the saw dry or with too little oil will decrease cutting efficiency, shorten chain saw life, and cause rapid dulling of the chain and excessive wear of the bar from overheating. Too little oil is evidenced by smoke or bar discoloration.

> Kickback.

Kickback is the sudden backward/upward motion of the chain saw, occurring when the chain (at the tip of the chain bar) comes in contact with a log or wood, or when the chain becomes jammed. When kickback occurs the chain saw reacts unpredictably and can cause severe injuries to the operator or bystanders. Particular attention must be given when sawing sideward, slanted or during length cuts, as the spiked bumper usually can not be applied.

To avoid kickback:

- > Saw with guide bar at a flat angle:
 - > Never work with a loose, widely stretched or the heavily worn out chain:
 - > Ensure chain is sharpened correctly:
 - > Never saw above shoulder height:
 - > Never work with the tip of the guide bar:
 - > Always hold the chain saw firmly with both hands:
 - > Always use a low kickback chain:
 - > Apply the metal gripping teeth for leverage:
 - > Ensure correct chain tension:
-

Hold the machine

Always hold the chain saw firmly with both hands.

Front grip with the left hand and rear grip with the right hand. Fully grip both handles at all times during operation. Never operate chain saw using only one hand. Ensure power cord is located to the rear, away from the chain and wood and so positioned that it will

OPERATE

not be caught on branches or the like during cutting. Use the chain saw only with secure footing. Hold the chain saw at the right-hand side of your body

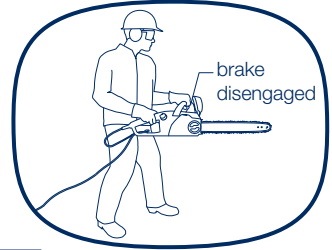

Switch on / off

Switch on the machine: press the lock-off button ①, then fully press the on/off switch ② and hold in this position to start the cutting work.

The lock-off button ① can now be released.

Release the Trigger switch On / Off ② to stop the machine, the chain stops completely after a few seconds.

Do not stop chain saw when sawing through activating the front hand guard (chain brake)!

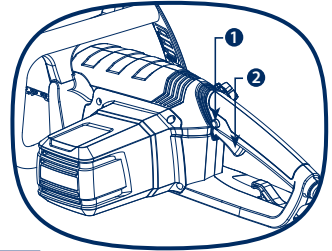

Start cutting

The chain must be running at full speed before it makes contact with the wood. Use the metal gripping teeth to secure the saw onto the wood before starting to cut. Use the gripping teeth as a leverage point while cutting.

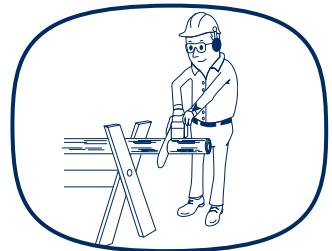

- > Reset the gripping teeth at a low point when sawing thicker logs by pulling the chain saw slightly backwards until the gripping teeth release, and reposition at lower level to continue sawing. Do not remove the saw completely from the wood.
- > Do not force the chain while cutting, let the chain do the work, using the gripping teeth to apply minimal leverage pressure.

OPERATE

- > Do not operate the chain saw with arms fully extended or attempt to saw areas which are difficult to reach, or on a ladder. Never use the chain saw above shoulder height.
 - > Sawing is optimized when the chain speed remains steady during cutting.
 - > Beware when reaching the end of the cut. The weight of the saw may change unexpectedly as it cuts free from the wood. Accidents can occur to the legs and feet. Always remove the saw from a wood cut while the saw is running.
 - > Cutting logs. Observe the following safety instructions:
 - > Support logs so that the face sides at the cut do not close in against each other, which would result in the chain being jammed or pinched.
 - > Position and set short logs safety prior to sawing. Saw only wood or wooden objects. When sawing, always take care to avoid hitting stones, nails, etc, as these could be thrown up or cause damage to the chain or serious injury to the operator or bystanders.
 - > Keep a running saw clear of wire fencing or the ground. Use of the saw to thin out branches or bushes is not approved.
 - > Length cuts must be carried out with care, as leverage with the gripping teeth is not possible. Saw at a flat angle to avoid kickback.
 - > When working on a slope, operate above or to the side of the trunk or laying tree.
 - > Be careful not to trip over tree stumps, branches, roots, etc.
-

OPERATE

Disconnect the power source

Disconnect the plug source for safety. When the machine is cooled down for several minutes, it is advised to put on the blade protection cover for longer storage.

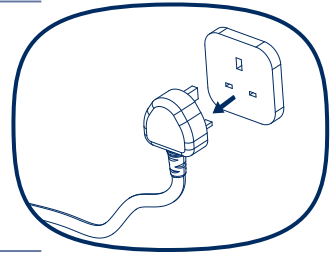

Tips:

I. Felling.

Felling is the term for cutting down a tree. Small trees up to 15-18cm in diameter are usually cut in a single cut. Larger trees require notch cuts. Notch cuts determine the direction the tree will fall.

Warning! A retreat path (A) should be planned and cleared as necessary before cuts are started. The retreat path should extend back and diagonally to the rear of the expected line.

Warning! If felling a tree on sloping ground, the chain saw operator should keep on the uphill side of the terrain, as the tree is likely roll or slide down hill after is felled.

Note: Direction of fall (B) is controlled by the notching cut. Before any cuts are made, consider the location of larger branches and natural leaves of the tree as well as the wind direction to determine the way the tree will fall.

Warning! Do not cut down a tree during high or changing winds or if there is a danger of striking utility wires. Consult a tree professional. Do not cut down a tree if there is a danger of striking utility wires: notify the utility company before making any cuts. Remove dirt, stones, loose bark, nails, staples and wire from the tree.

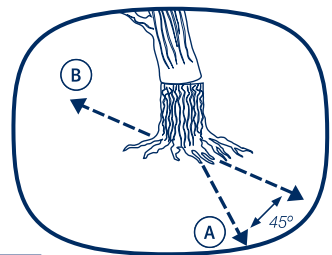

OPERATE

II. General guidelines for felling trees.

Normally felling consists of 2 main cutting operations, notching(C) and making the felling cut (D). Start making the upper notch cut (C) on the side of the tree facing the felling direction (E). Be sure you don't make the lower cut too deep into the trunk. The notch (e) should be deep enough to create a hinge (F) of sufficient width and strength. The notch should be Fig 23 wide enough to direct the fall of the tree for as long as possible.

Warning! Never walk in front of a tree that has been notched. Make the felling cut (D) from the other side of the tree and 3-5cm above the edge of the notch (C).

Warning! Don't use the saw above shoulder-height, because of difficult handling of the chainsaw which can cause serious injury. Take care of a stable position so you have good control on the chain saw.

Never saw completely through the trunk. Always leave a hinge. The hinge guides the tree. If the trunk is completely cut through, control over the felling direction is lost. Insert a wedge or felling lever in the cut well before the tree becomes unstable and starts to move. This will prevent the guide bar from binding in the felling cut if you have misjudged the falling direction. Make sure no bystanders have entered the range of the falling tree before you push it over.

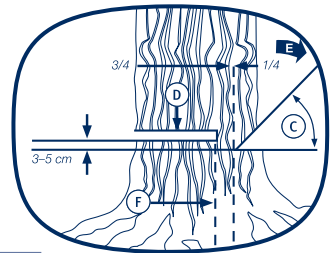

Warning: As the felling cut (D) gets close to the hinge (F), the tree should begin to fall. Remove saw from cut, stop the engine, put the chainsaw down and leave the area by the retreat path.

III. Felling cut.

Use wooden or plastic wedges (A) to prevent binding the bar or chain (B) in the cut. Wedges also control felling.

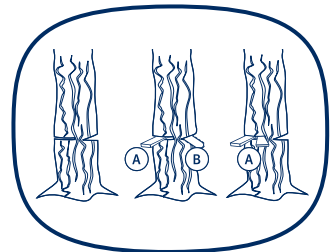

OPERATE

When diameter of wood being cut is greater than the bar length, make 2 cuts as shown.

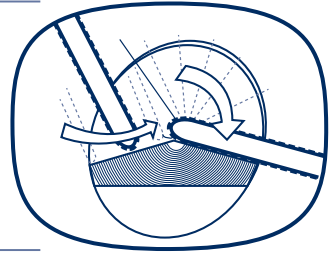

Limbing

Limbing a tree is the process of removing the branches from a fallen tree. Do not remove supporting limbs (A) until after the log is bucked (cut) into lengths. Branches under tension should be cut from the bottom up to avoid binding the chain saw.

Warning: Never cut tree limbs while standing on tree trunk.

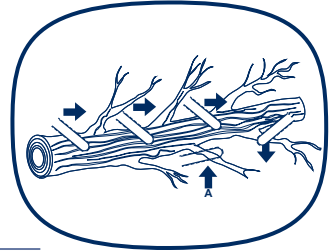

Bucking

Bucking is cutting a fallen log into lengths. Make sure you have a good footing and stand up hill of the log when cutting on sloping ground. If possible, the log should be supported so that the end to be cut off is not resting on the ground. If the log is supported at both ends and you must cut in the middle, make a downward cut halfway through the log and then make the undercut. This will prevent the log from pinching the bar and chain.

Be careful that the chain does not cut into the ground when bucking as this causes rapid dulling of the chain. When bucking on a slope, always stand on the uphill side.

> Log supported along entire length: Cut from top (over buck), being careful to avoid cutting into the ground

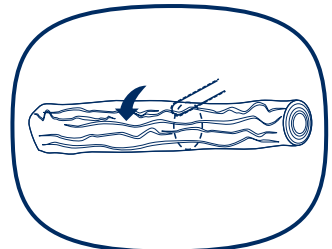

OPERATE

Log supported on 1 end: First, cut from bottom (under buck) 1/3 diameter of log to avoid splintering.

Second, cut from above (over buck) to meet first cut and avoid pinching

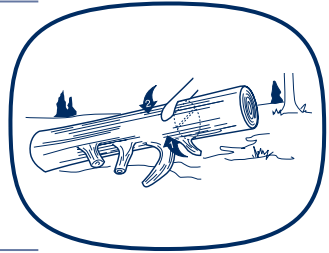

> Log supported on both ends: First, over buck 1/3 diameter of log to avoid splintering. Second, under buck to meet first cut and avoid pinching.

Note: The best way to hold a log while bucking is to use a sawhorse. When this is not possible, the log should be raised and supported by the limb stumps or by using supporting logs. Be sure the log being cut is securely supported.

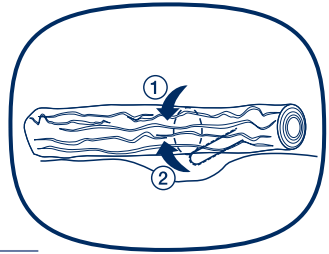

Bucking using a sawhorse

For personal safety and ease of cutting, the correct position for vertical bucking is essential. Vertical cutting:

- > Hold the saw firmly with both hands and keep the saw to the right of your body while cutting.
- > Keep the left arm as straight as possible.
- > Keep weight on both feet.

Caution! While the saw is cutting, be sure the chain and bar are being properly lubricated.

The three golden rules for care

1. Regularly grease the moving parts .
2. Check that ventilation holes , bar rails and oil passages are always unobstructed and clean.
3. Clean the chain saw with a soft brush and clean cloth . Do not use water , solvents or polishers.

OPERATE

Replacing/changing chain and guide bar

Fit the chain and guide bar as described in “Assembly and Tensioning Chain”. The circular groove of the guide bar will wear particularly on the lower edge with time. When replacing the chain turn the chain bar 180° to allow even wear, thus extending chain bar life. Check drive sprocket. If it is worn out or damaged due to strain, have it exchanged by an authorized service agent. If the chain bar is worn out or damaged, have it exchanged by an authorized service agent

MAINTENANCE



Warning: Disconnect the power source before servicing, sever injury or death could occur from electrical shock or body contact with moving chain.



Warning: Cutting edges or chain are sharp, use protective gloves when handling chain.



Warning: Do not use water, solvents or polishes as medium for clearance and maintenance. Remove all debris, especially from the motor cooling vents.

Adjust the chain tension

Loosen the bar locking knob (the inner circle) slightly, but do not remove the side cover.

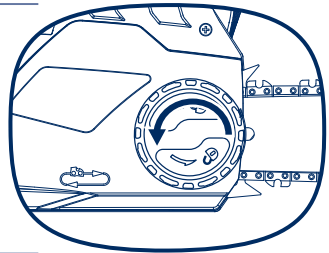

Hold up the nose of the guide bar and turn the chain tensioning knob (the out circle) clockwise.

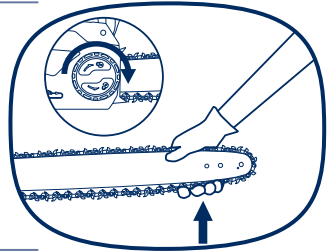

When the saw chain is tensioned with 9N (approx. 1kg), the gap between the saw chain and the guide rail should never be more than 2mm.

Do not over tension the chain as this will reduce life of chain bar and motor. With a correctly tensioned chain you will get good cutting performance and a longer life.

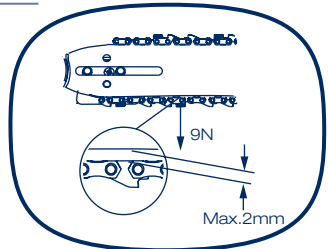

MAINTENANCE

Tighten the bar locking knob(the inner circle) by turning it counter-clockwise.

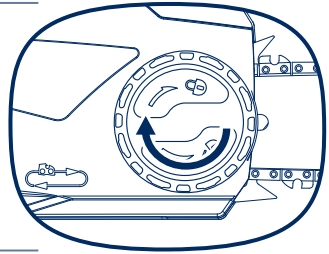

Cleaning saw body

Keep saw body clean, use a soft cloth dampened with a mild soap and water mixture, wipe saw body to clean.

clean the area under the cover plate, the drive sprocket and chain bar assembly using a soft brush. And oil outlet with a clean cloth.

Care of the chain

Remove sheath and clean the chain with a clean cloth after 1 to 3 hours of use.

When working,keep it is with chain oil.

And use tool to sharpen the chain when it become not sharp.

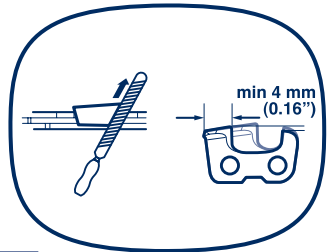
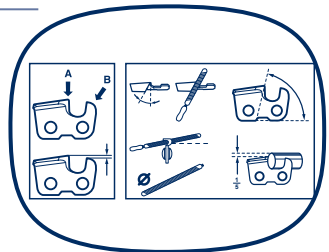

MAINTENANCE

Care of guide bar

Wear gloves.

- Unplug the chain saw.
- Loosen the side cover release knob slightly, but do not remove the side cover.
- Loosen the chain tensioning ring (turn it counter clockwise) as far as it will go.
- Loosen the side cover release knob and remove the side cover.
- Remove the bar and chain and inspect for damage and wear.
- Remove the screw from the back side of the chain tensioning gear and remove the chain tensioning gear from the guide bar.(Fig.9)

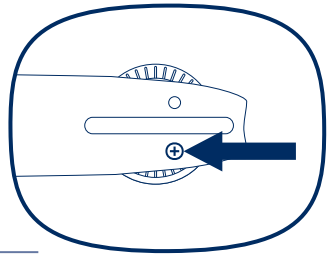

Flip the bar

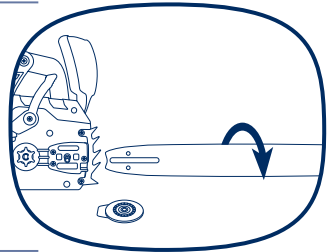

- There is a rubber washer that is important to the function of the chain lubrication. The rubber washer must be in place around the pin on the tensioner before the tensioner is screwed onto the bar

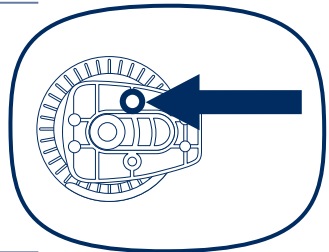

MAINTENANCE

- Place the chain tensioning gear on the side of the guide bar facing you such that the rectangular piece does not protrude past the edges of the guide bar and replace the screw.
- Place the guide bar on the bar pad by sliding the bar slot over the alignment flange.

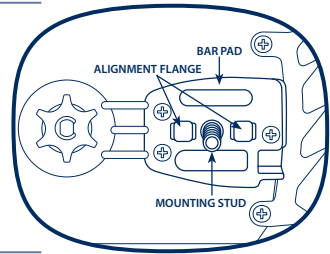

Remove guide bar from chain saw. remove sawdust from guide bar groove periodically. use putty knife or wire. clean oil slots after each day of use. remove burrs from sides of guide bar. use flat file to make side edges square.

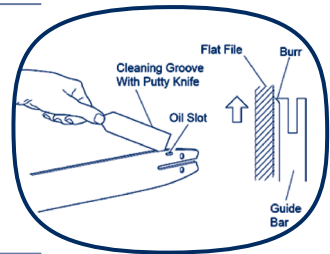

IMPORTANT! Remove and brush clean the cover plate, chain and chain bar after 1 to 3 hours of use.

Inspect guide bar before sharpening chain. A worn or damaged guide bar is unsafe. A worn or damaged guide bar will damage chain, it will also make cutting harder. replaces guide bar if this occurs.

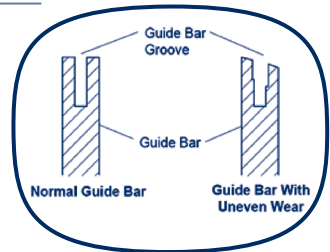

Storing

If the chain saw is to be stored for a longer period of time, clean chain and chain bar.

Store in a secure, dry place out of the reach of children. do not place other objects on the chain saw. to prevent leakage ensure machine is left in a horizontal position (oil tank cap uppermost). when storing machine in original packaging the oil tank must be completely emptied.

TECHNICAL DATA

Model	YT4353-01
Voltage	220-240V/50Hz
Rated power	2000W
No-load speed	8000/min
Bar length	40cm
Chain speed	13.5 m/s
Oil tank capacity	150ml
Chain pitch	3/8"
Number of chain links	56
Chain gauge	0.05"
Protection class	II 
Machine weight (chain & bar included)	6.6kg
Sound pressure level LPA	93.99dB(A)
Sound power level LWA	104.32dB(A)
Guaranteed sound power level LWA	110dB(A)
Vibration a_n	5.084m/s ² K=1.5m/s ²

PART NUMBER	ACCESSORIES
91PJ056X	Chain
160SDEA041	Bar

Environmental Protection



Waste electrical products should not be disposed of with household waste. Please recycle where facilities exist. Check with your Local Authority or retailer for recycling advice.

TROUBLESHOOTING

Never use tools with defective On/Off switches or defective Kickback brake(Hand Guard).

In the case of all other types of technical faults, please contact helpline 0345 605 2070 or local service center.

Fault	Possible Cause	Solution
Tool will not start	Lock button not pressed.	Press the lock button.
	"Front guard in the brake position"	Reset front guard
	Blown fuse	Replace fuse
	Tripped RCD	Check RCD
	TMains loead not connected	Check mains supply
Chain does not stop within 2 seconds when the tool is switched off	Chain tension is too slack	Check chain tension
"Bar/chain appear hot/smoking"	Oil tank empty	Check oil tank level
	Oil hole blocked on chain bar	Clean oil hole and clear the groove around the edge of the chainbar.
	Chain tension is too tight	Check chain tension
	"Guide bar sprocket nose needs greasing"	"Oil the guide bar sprocket nose"
Chainsaw does not cut well	Chain on backwards	"Check/modify chain direction"
		Sharpen
Chainsaw not using oil	Debris in tank	Empty oil from tank and replace
	Oil hole in cap blocked	"Remove debris from hole"
	Debris in chain bar	"Remove debris and clean the chain bar"
	Debris in oil outlet	Remove debris

WARRANTY

If your device develops a fault, please don't hesitate to contact our customer service department on 0345 605 2070, we can solve 80% of problems via the phone.

1. These warranty terms cover additional warranty rights and do not affect your statutory warranty rights. All our products are covered by a 3 year manufacturer warranty.
2. Claims must be accompanied by proof of purchase. This must be in the form of a sales receipt or bank statement and must show that the product has been purchased within the warranty period as described under point 1, from the retailer that it was originally bought from. Please keep your receipt safe or staple it to the back of this manual for future reference.
3. Our warranty covers problems caused by material or manufacturing defects, and will result in the repair of these defects or replacement of the device with a like for like or similar article.
4. Our devices have not been designed for commercial, trade or industrial applications, any signs of use of the equipment in these application or equivalent activities, invalidates the warranty.
5. The following are also excluded from our warranty:
 - A. Faults due to accidents, customer misuse or unauthorized repairs
 - B. Consumable Parts such as chain, bar and other accessories that are compatible with the product.
 - C. Failure due to lack of routine maintenance.
 - D. Failure as a result of not using the equipment in accordance with the manual and safety instructions

Warranty claims should be submitted before the end of the warranty period, see point 1, but a paid service exists for repairs commissioned after this period. The original warranty period remains applicable to the device even if repairs are carried out or parts are replaced. In such cases, the work performed or parts fitted will not result in an extension of the warranty period, and no new warranty will become active for the work performed or parts fitted.

If you have any problems or questions concerning your garden power tool, please contact our after sales service at 0345 605 2070.

This device may be re-conditioned, like for like or upgraded replacement.

